

New a Series New c Series New e Series

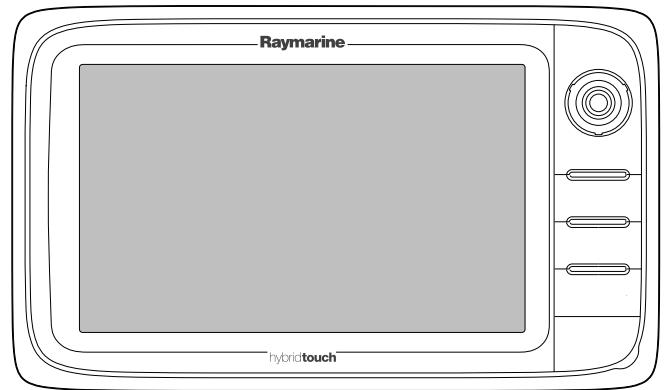

SVMB

Installation and operation instructions

English

Date: 10-2012

Document number: 81337-5-EN

© 2012 Raymarine UK Limited

SWIB

Trademark and patents notice

Autohelm, hsb², RayTech Navigator, Sail Pilot, SeaTalk, SeaTalk^{NG}, SeaTalk^{HS} and Sportpilot are registered trademarks of Raymarine UK Limited. RayTalk, Seahawk, Smartpilot, Pathfinder and Raymarine are registered trademarks of Raymarine Holdings Limited.

FLIR is a registered trademark of FLIR Systems, Inc. and/or its subsidiaries.

All other trademarks, trade names, or company names referenced herein are used for identification only and are the property of their respective owners.

This product is protected by patents, design patents, patents pending, or design patents pending.

Fair Use Statement

You may print no more than three copies of this manual for your own use. You may not make any further copies or distribute or use the manual in any other way including without limitation exploiting the manual commercially or giving or selling copies to third parties.

Software updates

Check the website www.raymarine.com for the latest software releases for your product.

Product handbooks

The latest versions of all English and translated handbooks are available to download in PDF format from the website www.raymarine.com. Please check the website to ensure you have the latest handbooks.

Copyright ©2012 Raymarine UK Ltd. All rights reserved.

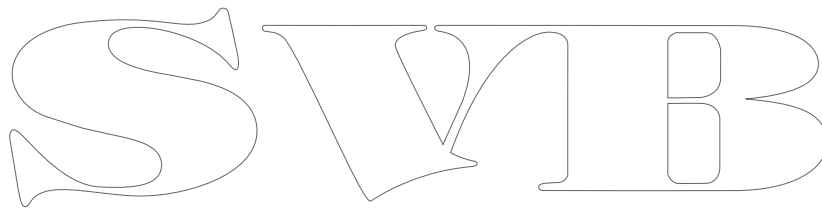

The logo consists of the letters 'S', 'W', and 'B' in a large, stylized, outlined font. The 'S' is on the left, the 'W' is in the middle, and the 'B' is on the right. The letters are interconnected and have a decorative, slightly irregular appearance.

SWIB

Contents

Chapter 1 Important information.....	9	4.8 Fastheading connection.....	50
TFT Displays.....	9	4.9 SeaTalk ^{ng} connections.....	50
Water ingress.....	10	4.10 SeaTalk connection.....	52
Disclaimers.....	10	4.11 NMEA 0183 connection.....	52
Chart cards and memory cards.....	10	4.12 NMEA 2000 connection.....	53
EMC installation guidelines.....	10	4.13 Camera / Video connection.....	54
RF exposure.....	10	4.14 Camera / video in-out connection.....	54
FCC.....	10	4.15 Bluetooth connections.....	55
Compliance Statement (Part 15.19).....	10	4.16 WiFi connections.....	56
FCC Interference Statement (Part 15.105 (b)).....	10	Chapter 5 Location and mounting.....	57
Industry Canada.....	10	5.1 Selecting a location.....	58
Industry Canada (Français).....	11	5.2 Mounting - New a Series.....	59
Third party software license agreements.....	11	5.3 Mounting - New c Series and New e series.....	61
Suppression ferrites.....	11	Chapter 6 Getting started.....	65
Connections to other equipment.....	11	6.1 Display power.....	66
Declaration of conformity.....	11	6.2 New a Series Controls.....	66
Product disposal.....	11	6.3 e7 / e7D Controls.....	67
Pixel defect policy.....	11	6.4 c95 / c97 / c125 / c127 / e95 / e97 / e125 / e127 / e165 Controls.....	67
Warranty registration.....	11	6.5 Hybridtouch overview.....	69
IMO and SOLAS.....	11	6.6 Touchscreen overview.....	69
Technical accuracy.....	11	6.7 Homescreen overview — New a Series.....	70
Chapter 2 Handbook information.....	13	6.8 Homescreen overview — New c Series / New e Series.....	70
2.1 Handbook information.....	14	6.9 System checks.....	71
2.2 Product information.....	15	6.10 Enabling autopilot functions.....	74
2.3 Handbook illustrations.....	16	6.11 Enabling AIS functions.....	74
2.4 Handbook conventions.....	17	6.12 Language selection.....	75
2.5 Touch and non-touch operations.....	19	6.13 Pages.....	75
Chapter 3 Planning the installation.....	21	6.14 Applications.....	76
3.1 System integration.....	22	6.15 Splitscreen controls.....	77
3.2 Installation checklist.....	26	6.16 Screen overview.....	78
3.3 System Limits.....	26	6.17 Editing information in dialogs.....	80
3.4 Multiple data sources (MDS) overview.....	27	6.18 Editing numerical settings.....	81
3.5 Identifying your display variant.....	27	6.19 Basic touchscreen operations.....	81
3.6 Networking constraints.....	28	6.20 Databar status symbols.....	82
3.7 Typical systems.....	29	6.21 Initial set up procedures.....	83
3.8 System protocols.....	32	Chapter 7 Managing display data.....	87
3.9 Data master.....	33	7.1 Memory cards overview.....	88
3.10 New a Series parts supplied.....	33	7.2 Inserting a memory card or chart card.....	88
3.11 e7 / e7D Parts supplied.....	34	7.3 Removing a memory card or chart card.....	89
3.12 New c Series and New e Series parts supplied.....	34	7.4 Saving user data and user settings.....	89
3.13 Tools required for installation.....	35	7.5 Screenshots.....	92
Chapter 4 Cables and connections.....	37	7.6 Resetting your system.....	92
4.1 General cabling guidance.....	38	Chapter 8 Using the document viewer.....	93
4.2 Connections overview.....	39	8.1 Document viewer overview.....	94
4.3 Power connection — New a Series.....	40	Chapter 9 Using autopilot control.....	97
4.4 Power connection — New c Series and New e Series.....	41	9.1 Autopilot control.....	98
4.5 Network connections.....	43	9.2 Autopilot status symbols.....	99
4.6 GPS connection.....	49	9.3 Autopilot alarms.....	100
4.7 AIS connection.....	49		

Chapter 10 Using alarms and MOB functions	101	14.6 AIS status symbols	165
10.1 Using Man Overboard (MOB) functions	102	14.7 AIS silent mode	165
10.2 Alarms	103	14.8 AIS target symbols	166
Chapter 11 Using waypoints, routes and tracks	107	14.9 Displaying detailed AIS target information	166
11.1 Waypoints	108	14.10 Viewing all AIS targets	167
11.2 Routes	113	14.11 Using AIS to avoid collisions	167
11.3 Tracks	116	14.12 AIS options	168
11.4 Waypoints, routes and tracks storage capacity	118	14.13 AIS alarms	169
Chapter 12 Using the chart	119	14.14 Buddy tracking	169
12.1 Chart application overview	120	Chapter 15 Using the fishfinder	171
12.2 Chart ranging and panning	121	15.1 How the fishfinder works	172
12.3 Vessel position and orientation	122	15.2 Raymarine sonar modules	172
12.4 Chart views	124	15.3 Traditional sonar technology	173
12.5 Chart context menu	125	15.4 Broadband CHIRP sonar technology	173
12.6 My Data options	126	15.5 Fishfinder introduction	174
12.7 Navigation options	126	15.6 Transducer bandwidth	175
12.8 Measuring distances and bearings	127	15.7 The sonar image	175
12.9 Chart vectors	127	15.8 Fishfinder presets	176
12.10 Current information	128	15.9 Dual / Single frequency fishfinder	177
12.11 Tide information	129	15.10 Non-CHIRP (traditional) sonar module frequency controls	177
12.12 Chart object information	130	15.11 CHIRP sonar module frequency controls	178
12.13 Chart presentation	131	15.12 Fishfinder display modes	180
12.14 Chart set-up menu options	135	15.13 Fishfinder range	181
Chapter 13 Using radar	139	15.14 Fishfinder sensitivity settings	182
13.1 Radar overview	140	15.15 Fishfinder presentation options	185
13.2 Radar scan speed	141	15.16 Depth and distance with the fishfinder	186
13.3 Radar scanner status symbols	141	15.17 Fishfinder scrolling	187
13.4 Radar range and image quality	142	15.18 Fishfinder waypoints	188
13.5 Radar display overview	144	15.19 Fishfinder alarms	188
13.6 Dual range radar operation	145	15.20 Sounder set-up menu options	189
13.7 Radar mode and orientation	146	15.21 Transducer set-up menu options	190
13.8  Radar tuning: On-screen gain controls	148	15.22 Resetting the sonar	191
13.9 Radar adjustments: HD and SuperHD scanners	149	Chapter 16 Using the data application	193
13.10 Radar adjustments: non-HD digital radomes	151	16.1 Data application overview	194
13.11 Radar presentation menu options	152	16.2 Pre-configured datapages	194
13.12 Using radar to measure distances, ranges, and bearings	154	16.3 Customizing the data application	196
13.13 Using radar to track targets and avoid collisions	156	Chapter 17 Using the fuel manager	203
13.14 Scanner set-up menu options	159	17.1 Fuel manager overview	204
13.15 Resetting the radar	160	Chapter 18 Using the weather application (North America only)	207
Chapter 14 Using AIS	161	18.1 Weather application overview	208
14.1 AIS overview	162	18.2 Weather application set up	208
14.2 AIS prerequisites	163	18.3 Weather application display overview	209
14.3 AIS context menu	163	18.4 Weather map navigation	212
14.4 Enabling AIS	164	18.5 Weather context menu	212
14.5 Displaying AIS vectors	164	18.6 Weather information	213
		18.7 Weather reports	213
		18.8 Animated weather graphics	214
		18.9 Weather application menu options	215
		18.10 Glossary of weather terms	216

Chapter 19 Using the thermal camera application.....	219	27.2 Power up troubleshooting	275
19.1 Thermal camera application overview	220	27.3 Radar troubleshooting	276
19.2 Thermal camera image	220	27.4 GPS troubleshooting	277
19.3 Controls overview	221	27.5 Sonar troubleshooting	278
19.4 Camera control	222	27.6 Thermal camera troubleshooting	279
19.5 Image adjustments	224	27.7 System data troubleshooting	280
19.6 Camera set-up menu	226	27.8 Video troubleshooting	281
Chapter 20 Using the camera application	229	27.9 Wi-Fi troubleshooting.....	282
20.1 Camera application overview	230	27.10 Bluetooth troubleshooting	283
Chapter 21 Using mobile applications	233	27.11 Touchscreen troubleshooting	284
21.1 Raymarine mobile apps	234	27.12 Miscellaneous troubleshooting	285
21.2 Enabling Wi-Fi	235	Chapter 28 Technical support	287
21.3 Enabling mobile apps	235	28.1 Raymarine customer support	288
21.4 Setting up Wi-Fi security	236	28.2 Third-party support.....	288
21.5 Selecting a Wi-Fi channel	236	Chapter 29 Technical specification.....	289
Chapter 22 Media player application	237	29.1 Technical specification	290
22.1 Media player connection	238	Chapter 30 Spares and accessories	293
22.2 Enabling Bluetooth	238	30.1 Transducer accessories	294
22.3 Pairing a Bluetooth media player	239	30.2 RayNet connector network cables	294
22.4 Enabling audio control	239	30.3 SeaTalk ^{hs} network cables.....	295
22.5  Media player controls.....	240	30.4 SeaTalk ^{hs} patch cables	295
22.6  Media player controls using a remote control	240	30.5 Video cables	296
22.7 Unpairing a Bluetooth device	241	30.6 Power cables	296
Chapter 23 Using a remote control.....	243	30.7 a65 / a67 spares	297
23.1 Remote control connection	244	30.8 e7 e7D spares	297
23.2 Pairing the remote and configuring the UP and DOWN buttons	244	30.9 e95 / e97 / c95 / c97 spares	298
23.3 Operating principles	245	30.10 e125 / e127 / c125 / c127 spares.....	298
23.4 Customizing the SHORTCUT button.....	245	30.11 e165 Spares.....	299
23.5 Remote control functions	246	Appendix A NMEA 0183 sentences	301
23.6 Reconnecting the RCU	247	Appendix B NMEA 2000 sentences	302
Chapter 24 DSC VHF radio integration.....	249	Appendix C Connectors and pinouts	304
24.1 Using a DSC VHF radio with your display	250	Appendix D Software releases	305
24.2 Enabling DSC VHF radio integration.....	250		
Chapter 25 Customizing your display	251		
25.1 Language selection	252		
25.2 Boat details.....	253		
25.3 Units set-up	254		
25.4 Time and Date set-up	255		
25.5 Display preferences.....	256		
25.6 Data cell and databar customization	258		
25.7 System set-up menus	262		
Chapter 26 Maintaining your display.....	271		
26.1 Service and maintenance	272		
26.2 Cleaning	272		
Chapter 27 Troubleshooting.....	273		
27.1 Troubleshooting	274		

SWIB

Chapter 1: Important information



Warning: Product installation and operation

This product must be installed and operated in accordance with the instructions provided. Failure to do so could result in personal injury, damage to your vessel and/or poor product performance.



Warning: Potential ignition source

This product is NOT approved for use in hazardous/flammable atmospheres. Do NOT install in a hazardous/flammable atmosphere (such as in an engine room or near fuel tanks).



Warning: High voltages

This product contains high voltages. Do NOT remove any covers or otherwise attempt to access internal components, unless specifically instructed in this document.



Warning: Product grounding

Before applying power to this product, ensure it has been correctly grounded, in accordance with the instructions in this guide.



Warning: Switch off power supply

Ensure the vessel's power supply is switched OFF before starting to install this product. Do NOT connect or disconnect equipment with the power switched on, unless instructed in this document.



Warning: FCC Warning (Part 15.21)

Changes or modifications to this equipment not expressly approved in writing by Raymarine Incorporated could violate compliance with FCC rules and void the user's authority to operate the equipment.



Warning: Radar scanner safety

Before rotating the radar scanner, ensure all personnel are clear.



Warning: Radar transmission safety

The radar scanner transmits electromagnetic energy. Ensure all personnel are clear of the scanner when the radar is transmitting.



Warning: Sonar operation

- NEVER operate the sonar with the vessel out of the water.
- NEVER touch the transducer face when the sonar is powered on.
- SWITCH OFF the sonar if divers are likely to be within 7.6 m (25 ft) of the transducer.



Warning: Touchscreen display

When exposed to prolonged periods of direct sunlight, the touchscreen display can get very hot. In such conditions, avoid using the touchscreen display or use the unit's physical keys and buttons instead if available.



Warning: Touchscreen display

Exposure to prolonged rain may cause erroneous touch performance, in these situations keep touch activity to a minimum and wipe the screen with a dry non-abrasive cloth before using the touchscreen.

Caution: Transducer cable

Do NOT cut, shorten, splice the transducer cable or remove the connector. If the cable is cut, it cannot be repaired. Cutting the cable will also void the warranty.

Caution: Power supply protection

When installing this product ensure the power source is adequately protected by means of a suitably-rated fuse or automatic circuit breaker.

Caution: Care of chart and memory cards

To avoid irreparable damage to and / or loss of data from chart and memory cards:

- Ensure that chart and memory cards are fitted the correct way around. DO NOT try to force a card into position.
- DO NOT save data (waypoints, routes, and so on) to a chart card, as the charts may be overwritten.
- DO NOT use a metallic instrument such as a screwdriver or pliers to insert or remove a chart or memory card.
- Safe removal. Always power the unit off before inserting or removing a chart or memory card.

Caution: Ensure chart card door is securely closed

To prevent water ingress and consequent damage to the display, ensure that the chart card door is firmly closed. This can be confirmed by an audible click.

Caution: Sun covers

- To protect your product against the damaging effects of ultraviolet (UV) light, always fit the sun covers when the product is not in use.
- Remove the sun covers when travelling at high speed, whether in water or when the vessel is being towed.

Caution: Cleaning

When cleaning this product:

- Do NOT wipe the display screen with a dry cloth, as this could scratch the screen coating.
- Do NOT use abrasive, or acid or ammonia based products.
- Do NOT use a jet wash.

TFT Displays

The colors of the display may seem to vary when viewed against a colored background or in colored light. This is a perfectly normal effect that can be seen with all color Thin Film Transistor (TFT) displays.

Water ingress

Water ingress disclaimer

Although the waterproof rating capacity of this product meets the IPX6 standard, water intrusion and subsequent equipment failure may occur if the product is subjected to commercial high-pressure washing. Raymarine will not warrant products subjected to high-pressure washing.

Disclaimers

This product (including the electronic charts) is intended to be used only as an aid to navigation. It is designed to facilitate use of official government charts, not replace them. Only official government charts and notices to mariners contain all the current information needed for safe navigation, and the captain is responsible for their prudent use. It is the user's responsibility to use official government charts, notices to mariners, caution and proper navigational skill when operating this or any other Raymarine product. This product supports electronic charts provided by third party data suppliers which may be embedded or stored on memory card. Use of such charts is subject to the supplier's End-User Licence Agreement included in the documentation for this product or supplied with the memory card (as applicable).

Raymarine does not warrant that this product is error-free or that it is compatible with products manufactured by any person or entity other than Raymarine.

This product uses digital chart data, and electronic information from the Global Positioning System (GPS) which may contain errors. Raymarine does not warrant the accuracy of such information and you are advised that errors in such information may cause the product to malfunction. Raymarine is not responsible for damages or injuries caused by your use or inability to use the product, by the interaction of the product with products manufactured by others, or by errors in chart data or information utilized by the product and supplied by third parties.

Chart cards and memory cards

Memory cards are used for archiving data and chart cards provide additional or upgraded charts.

Compatible cards

The following types of memory or chart card are compatible with your Raymarine product:

- micro Secure Digital Standard-Capacity (microSDSC)
- micro Secure Digital High-Capacity (microSDHC)

Note: The maximum card capacity supported is 32 GB.

Chart cards

Your product is pre-loaded with electronic charts (worldwide base map). If you wish to use different chart data, you can insert compatible chart cards into the unit's card slot.

Use branded chart cards and memory cards

When archiving data, Raymarine recommends the use of quality branded memory cards. Some brands of memory card may not work in your unit. Please contact customer support for a list of recommended cards.

EMC installation guidelines

Raymarine equipment and accessories conform to the appropriate Electromagnetic Compatibility (EMC) regulations, to minimize electromagnetic interference between equipment and minimize the effect such interference could have on the performance of your system

Correct installation is required to ensure that EMC performance is not compromised.

For **optimum** EMC performance we recommend that wherever possible:

- Raymarine equipment and cables connected to it are:

- At least 1 m (3 ft) from any equipment transmitting or cables carrying radio signals e.g. VHF radios, cables and antennas. In the case of SSB radios, the distance should be increased to 7 ft (2 m).
- More than 2 m (7 ft) from the path of a radar beam. A radar beam can normally be assumed to spread 20 degrees above and below the radiating element.
- The product is supplied from a separate battery from that used for engine start. This is important to prevent erratic behavior and data loss which can occur if the engine start does not have a separate battery.
- Raymarine specified cables are used.
- Cables are not cut or extended, unless doing so is detailed in the installation manual.

Note: Where constraints on the installation prevent any of the above recommendations, always ensure the maximum possible separation between different items of electrical equipment, to provide the best conditions for EMC performance throughout the installation

RF exposure

This transmitter with its antenna is designed to comply with FCC / IC RF exposure limits for general population / uncontrolled exposure. The WiFi / Bluetooth antenna is mounted behind the front fascia on the left hand side of the screen. It is recommended to maintain a safe distance of at least 1 cm from the left hand side of the screen.

FCC

Compliance Statement (Part 15.19)

This device complies with Part 15 of the FCC Rules. Operation is subject to the following two conditions:

1. This device may not cause harmful interference.
2. This device must accept any interference received, including interference that may cause undesired operation.

FCC Interference Statement (Part 15.105 (b))

This equipment has been tested and found to comply with the limits for a Class B digital device, pursuant to Part 15 of the FCC Rules.

These limits are designed to provide reasonable protection against harmful interference in a residential installation. This equipment generates, uses, and can radiate radio frequency energy and, if not installed and used in accordance with the instructions, may cause harmful interference to radio communications. However, there is no guarantee that interference will not occur in a particular installation. If this equipment does cause harmful interference to radio or television reception, which can be determined by turning the equipment off and on, the user is encouraged to try to correct the interference by one of the following measures:

1. Reorient or relocate the receiving antenna.
2. Increase the separation between the equipment and receiver.
3. Connect the equipment into an outlet on a circuit different from that to which the receiver is connected.
4. Consult the dealer or an experienced radio / TV technician for help.

Industry Canada

This device complies with Industry Canada License-exempt RSS standard(s).

Operation is subject to the following two conditions:

1. This device may not cause interference; and
2. This device must accept any interference, including interference that may cause undesired operation of the device.

This Class B digital apparatus complies with Canadian ICES-003.

Industry Canada (Français)

Cet appareil est conforme aux normes d'exemption de licence RSS d'Industry Canada.

Son fonctionnement est soumis aux deux conditions suivantes:

1. cet appareil ne doit pas causer d'interférence, et
2. cet appareil doit accepter toute interférence, notamment les interférences qui peuvent affecter son fonctionnement.

Cet appareil numérique de la classe B est conforme à la norme NMB-003 du Canada.

Third party software license agreements

This product is subject to certain third party software license agreements as listed below:

- GNU — LGPL/GPL
- JPEG libraries
- OpenSSL
- FreeType

The license agreements for the above can be found on the documentation CD which accompanies this product.

Suppression ferrites

Raymarine cables may be fitted with suppression ferrites. These are important for correct EMC performance. If a ferrite has to be removed for any purpose (e.g. installation or maintenance), it must be replaced in the original position before the product is used.

Use only ferrites of the correct type, supplied by Raymarine authorized dealers.

Connections to other equipment

Requirement for ferrites on non-Raymarine cables

If your Raymarine equipment is to be connected to other equipment using a cable not supplied by Raymarine, a suppression ferrite MUST always be attached to the cable near the Raymarine unit.

Declaration of conformity

Raymarine UK Ltd. declares that this product is compliant with the essential requirements of R&TTE directive 1999/5/EC.

The original Declaration of Conformity certificate may be viewed on the relevant product page at www.raymarine.com.

Product disposal

Dispose of this product in accordance with the WEEE Directive.



■ The Waste Electrical and Electronic Equipment (WEEE) Directive requires the recycling of waste electrical and electronic equipment. Whilst the WEEE Directive does not apply to some Raymarine products, we support its policy and ask you to be aware of how to dispose of this product.

Pixel defect policy

In common with all TFT units, the screen may exhibit a few wrongly-illuminated ("dead") pixels. These may appear as black pixels in a light area of the screen or as colored pixels in black areas.

If your display exhibits MORE than the number of wrongly-illuminated pixels stated below, please contact your local Raymarine service center for further advice.

	a65 / a67	e7 / e7D	c95 / c97 / c125 / c127 / e95 / e97 / e125 / e127 / e165
Maximum acceptable wrongly-illuminated pixels	5	7	8

Warranty registration

To register your Raymarine product ownership, please visit www.raymarine.com and register online.

It is important that you register your product to receive full warranty benefits. Your unit package includes a bar code label indicating the serial number of the unit. You will need this serial number when registering your product online. You should retain the label for future reference.

IMO and SOLAS

The equipment described within this document is intended for use on leisure marine boats and workboats not covered by International Maritime Organization (IMO) and Safety of Life at Sea (SOLAS) Carriage Regulations.

Technical accuracy

To the best of our knowledge, the information in this document was correct at the time it was produced. However, Raymarine cannot accept liability for any inaccuracies or omissions it may contain. In addition, our policy of continuous product improvement may change specifications without notice. As a result, Raymarine cannot accept liability for any differences between the product and this document. Please check the Raymarine website (www.raymarine.com) to ensure you have the most up-to-date version(s) of the documentation for your product.

SWIB

Chapter 2: Handbook information

Chapter contents

- [2.1 Handbook information on page 14](#)
- [2.2 Product information on page 15](#)
- [2.3 Handbook illustrations on page 16](#)
- [2.4 Handbook conventions on page 17](#)
- [2.5 Touch and non-touch operations on page 19](#)

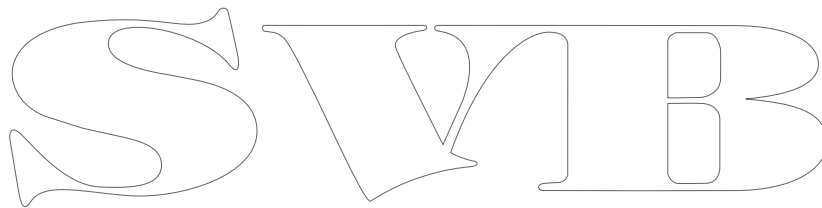

2.1 Handbook information

This handbook contains important information regarding your multifunction display.

The handbook is for use with the following Raymarine multifunction displays:

- New a Series
- New c Series
- New e Series

About this handbook

This handbook describes how to operate your multifunction display in conjunction with compatible electronic cartography and peripheral equipment.

It assumes that all peripheral equipment to be operated with it is compatible and has been correctly installed. This handbook is intended for users of varying marine abilities, but assumes a general level of knowledge of display use, nautical terminology and practices.

Handbooks

The following handbooks are applicable to your multifunction display:

Handbooks

All documents are available to download as PDFs from www.raymarine.com

New a Series Handbooks

Description	Part number
New a Series Mounting and getting started guide	88012
New a Series / New c Series / New e Series Installation and operation handbook	81337
a65 / a67 Mounting template	87165

New c Series Handbooks

Description	Part number
New c Series / New e Series Mounting and getting started guide	88001
New a Series / New c Series / New e Series Installation and operation handbook	81337
e95 / e97 / c95 / c97 Mounting template	87144
e125 / e127 / c125 / c127D Mounting template	87145

New e Series Handbooks

Description	Part number
e7 / e7D Mounting and getting started guide	88011
New c Series / New e Series Mounting and getting started guide	88001
New a Series / New c Series / New e Series Installation and operation handbook	81337
e7 / e7D Mounting template	87137
e95 / e97 / c95 / c97 Mounting template	87144
e125 / e127 / c125 / c127D Mounting template	87145
e165 Mounting template	87166





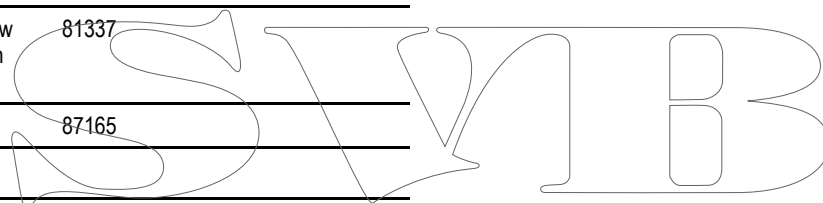







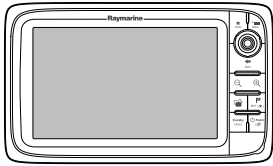

Additional handbooks

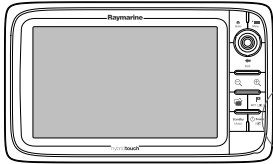
Description	Part number
SeaTalk [®] reference manual	81300

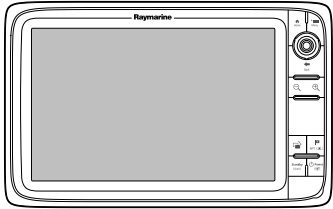

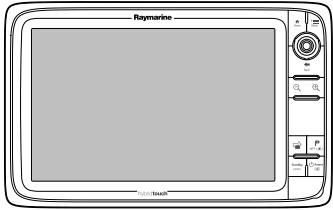
2.2 Product information

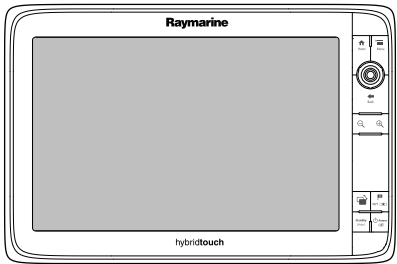
The following Raymarine multifunction display variants are available

	Non-sonar variant	Sonar variant	Series	Controls	Features
	a65 (E70076)	a67 (E70077)	New a Series	 Touchscreen only	<ul style="list-style-type: none"> • Bluetooth. • Internal GPS.
	e7 (E62354)	e7D (E62355)	New e Series	 HybridTouch (Touchscreen and physical buttons)	<ul style="list-style-type: none"> • Bluetooth. • Wi-Fi • NMEA 0183 • NMEA 2000 (via SeaTalk^{ng}) • Internal GPS. • Video input.
	c95 (E70011)	c97 (E70012)	New c Series	 Physical buttons only	<ul style="list-style-type: none"> • Bluetooth. • Wi-Fi • NMEA 0183 • NMEA 2000 (via SeaTalk^{ng}) • Internal GPS. • Video input.
	e95 (E70021)	e97 (E70022)	New e Series	 HybridTouch (Touchscreen and physical buttons)	<ul style="list-style-type: none"> • Bluetooth. • Wi-Fi • NMEA 0183 • NMEA 2000 (via SeaTalk^{ng}) • Internal GPS. • Video input x2. • Video output.
	c125 (E70013)	c127 (E70014)	New c Series	 Physical buttons only	<ul style="list-style-type: none"> • Bluetooth. • Wi-Fi • NMEA 0183 • NMEA 2000 (via SeaTalk^{ng}) • Internal GPS. • Video input.
	e125 (E70023)	e127 (E70024)	New e Series	 HybridTouch (Touchscreen and physical buttons)	<ul style="list-style-type: none"> • Bluetooth. • Wi-Fi • NMEA 0183 • NMEA 2000 (via SeaTalk^{ng}) • Internal GPS. • Video input x2. • Video output.
	e165 (E70025)	n/a	New e Series	 HybridTouch (Touchscreen and physical buttons)	<ul style="list-style-type: none"> • Bluetooth. • Wi-Fi • NMEA 0183 • NMEA 2000 (via SeaTalk^{ng}) • Video input x2. • Video output.

2.3 Handbook illustrations

The illustrations and screenshots used in this handbook may differ slightly from your display model.

The illustration of the multifunction display below is used throughout this manual and unless otherwise stated can apply to all variants of multifunction display (i.e. New a series, New c Series and New e Series).

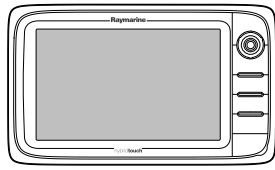





D12596-1

SVIB

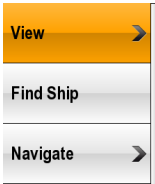

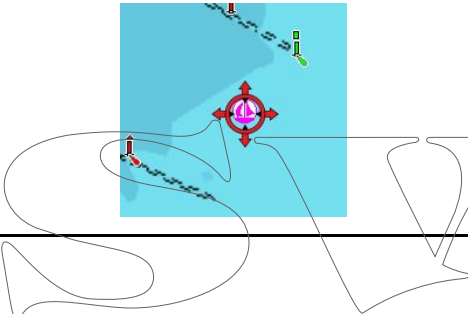
2.4 Handbook conventions

The following conventions are used throughout this handbook when referring to:

Type	Example	Convention
Icons		<p>The term "select" is used in procedures involving icons to refer to the action of selecting an on-screen icon, either using touch or physical buttons:</p> <ul style="list-style-type: none"> • Touch — Press your finger on the icon to select. • Physical buttons — Use the Joystick to highlight the icon and press the Ok button.
Menus		<p>The term "select" is used in procedures involving menus to refer to the action of selecting a menu item, either using touch or physical buttons:</p> <ul style="list-style-type: none"> • Touch — Press your finger on the icon to select. • Physical buttons — Use the Joystick to highlight the icon and press the Ok button.
		<p>The term "scroll" is used in procedures involving menus and dialogs to refer to the action of scrolling a list or menu, either by touch or physical buttons:</p> <ul style="list-style-type: none"> • Touch — Press your finger on the menu and slide up or down to scroll. • Physical buttons — Turn the Rotary control clockwise or anti-clockwise to scroll.
Applications		<p>The term "select" is used in procedures involving applications to refer to the action of selecting a location, object or target on-screen using touch or physical buttons:</p> <ul style="list-style-type: none"> • Touch — Press and hold your finger on a location to select, or • Touch — Press and release your finger on an object or target. • Physical buttons — Use the Joystick to highlight the location, object or target and press the Ok button.
Numeric adjust controls		<p>The term "adjust" is used in procedures involving numerical adjust controls to refer to the action of changing the numeric value using touch or physical buttons:</p> <ul style="list-style-type: none"> • Touch — Press your finger on the up or down arrow to increase or decrease the numeric value. • Physical buttons — Use the Rotary control to increase or decrease the numeric value. <p>With the Numeric adjust control displayed you can also select on the keypad icon or press and hold the Ok button to open a numeric keypad to enter a new value for the setting.</p>
Slider bar controls		<p>The term "adjust" is used in procedures involving slider bar controls to refer to the action of changing the associated numeric value using touch or physical buttons:</p> <ul style="list-style-type: none"> • Touch — Press your finger on the up or down arrow to increase or decrease the numeric value. • Physical buttons — Use the Rotary control to increase or decrease the numeric value.

Waypoint (MOB) button / icon

Depending on the multifunction display variant there will be either a Waypoint (MOB) button or an on-screen icon.

WPT button	 <p>WPT ()</p>	<ul style="list-style-type: none">• New c Series• New e Series
WPT icons		<ul style="list-style-type: none">• New a Series



Throughout this manual the term: Select **WPT**, refers to pressing the physical **WPT** button or pressing the on-screen **WPT** icon.

SWIB

2.5 Touch and non-touch operations

This handbook applies to New a Series, New c Series and New e Series multifunction displays. All features and functions can be accessed using physical buttons (non-touch) on New c Series and New e Series displays or by using the touchscreen on New a Series and New e Series displays.

This handbook uses icons throughout to identify whether a particular task is a touch or a non-touch operation.

	Touch (Touchscreen operation) — Touch operations apply to New a Series and New e Series multifunction displays.
	Non-touch (physical button operation) — Non-touch operations apply to New c Series and New e Series multifunction displays.

Note: Where a task does not have a touch or non-touch icon then the task applies to all display variants.

SVIB

SWIB

Chapter 3: Planning the installation

Chapter contents

- [3.1 System integration on page 22](#)
- [3.2 Installation checklist on page 26](#)
- [3.3 System Limits on page 26](#)
- [3.4 Multiple data sources \(MDS\) overview on page 27](#)
- [3.5 Identifying your display variant on page 27](#)
- [3.6 Networking constraints on page 28](#)
- [3.7 Typical systems on page 29](#)
- [3.8 System protocols on page 32](#)
- [3.9 Data master on page 33](#)
- [3.10 New a Series parts supplied on page 33](#)
- [3.11 e7 / e7D Parts supplied on page 34](#)
- [3.12 New c Series and New e Series parts supplied on page 34](#)
- [3.13 Tools required for installation on page 35](#)

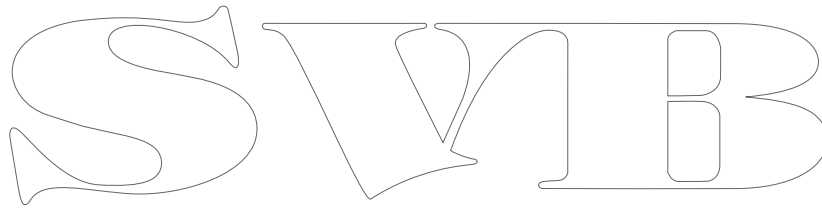

3.1 System integration

Your multifunction display is compatible with a wide range of marine electronics devices.

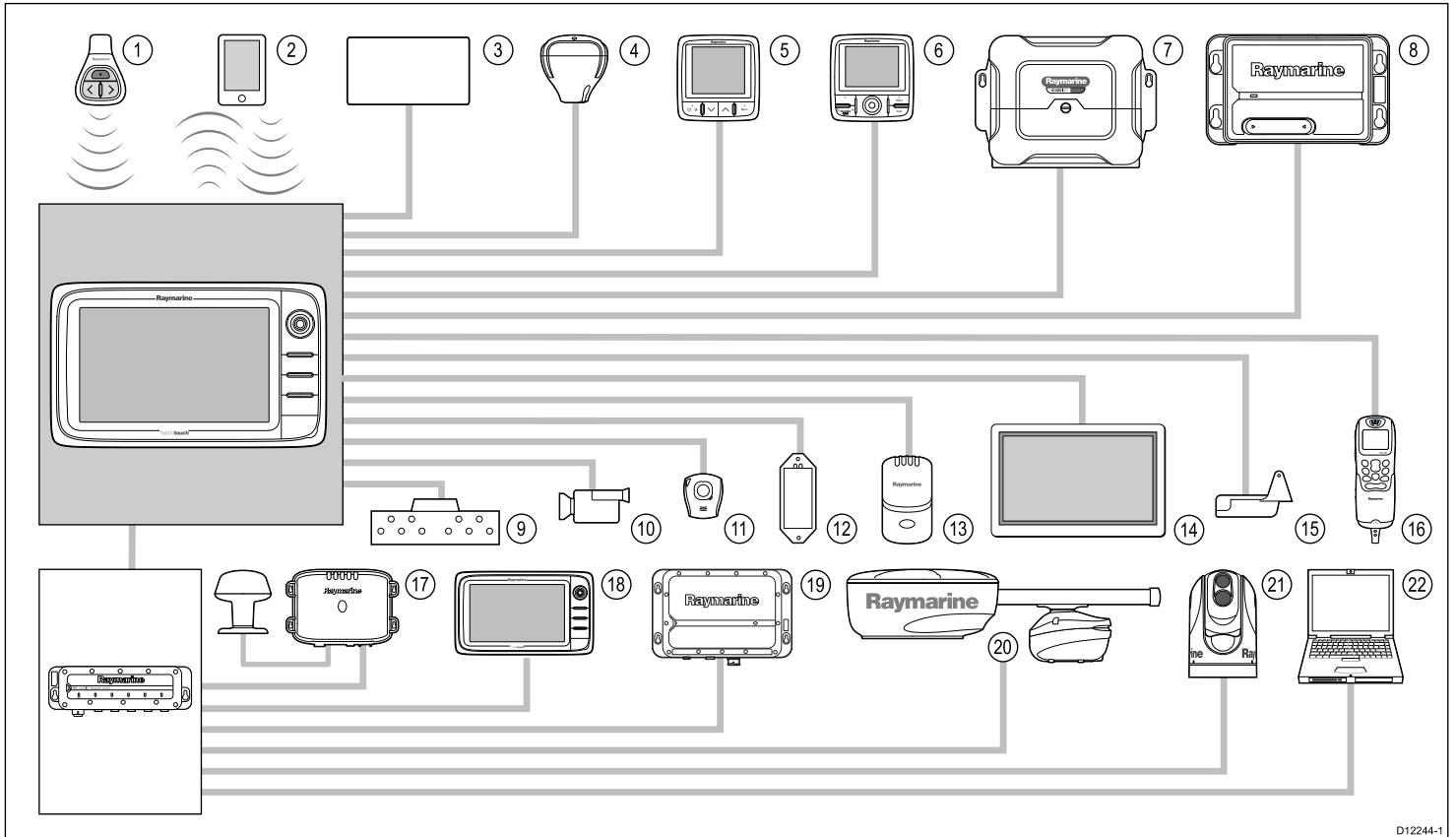

D12244-1

The display uses a number of protocols to transfer data between the various devices in your system. The following table details which devices may be connected to your display, and the type of connections (in terms of protocols and physical interfaces):

Item	Device Type	Maximum quantity	Suitable Devices	Connections
1	Remote control	1 per multifunction display.	Raymarine RCU-3	Bluetooth
2	Smartphone / Tablet device	1 per multifunction display.	<p>For Raymarine wireless video streaming and remote control apps:</p> <ul style="list-style-type: none"> • Apple iPhone 4 (or later) or iPad 2 (or later) • Android device with minimum 1GHz processor and running android 2.2.2 (or later) • Amazon Kindle Fire <p>For chartplotter sync with Navionics Marine app:</p> <ul style="list-style-type: none"> • Apple iPhone or iPad. • Android-compatible smartphone or tablet. <p>For media player control (New e Series only):</p> <ul style="list-style-type: none"> • Any Bluetooth-enabled device supporting Bluetooth AVRCP version 2.1 or higher. 	<ul style="list-style-type: none"> • Chartplotter sync with Navionics Marine app: Wi-Fi. • Video streaming and remote control: Wi-Fi. • Media player control: Bluetooth AVRCP 2.1 or later.
3	Vessel tank sensors — third-party	<ul style="list-style-type: none"> • Up to 3 x fuel. • 1 x fresh water. • 1 x waste water. • 1 x sewage. • 1 x bait / fish. 	Third-party NMEA 2000 interfaces.	NMEA 2000 (via optional DeviceNet adaptor cables).
4	GPS (external) — Raymarine	1	<p>Any combination of the following:</p> <ul style="list-style-type: none"> • Raystar125 GPS. • Raystar125+ GPS (via optional SeaTalk to SeaTalk^{ng} converter). • RS130 	SeaTalk, SeaTalk ^{ng} , or NMEA 0183.

Item	Device Type	Maximum quantity	Suitable Devices	Connections
5	Instruments — Raymarine	As determined by SeaTalk ^{ng} bus bandwidth and power loading.	SeaTalk (via optional SeaTalk to SeaTalk ^{ng} converter): <ul style="list-style-type: none"> • ST40 Wind, Speed, Depth, Rudder, or Compass. • ST60+ Wind, Speed, Depth, Rudder, or Compass. • i40 Wind, Speed, Depth, or Bidata. SeaTalk ^{ng} : <ul style="list-style-type: none"> • ST70. • ST70+. • ST70+ keypads. • i50 Depth, Speed, or Tridata • i60 Wind, CH Wind • i70. 	SeaTalk, SeaTalk ^{ng} .
6	Pilot control heads — Raymarine	As determined by SeaTalk or SeaTalk ^{ng} bus bandwidth and power loading, as appropriate.	SeaTalk (via optional SeaTalk to SeaTalk ^{ng} converter): <ul style="list-style-type: none"> • ST6002. • ST7002. • ST8002. SeaTalk ^{ng} : <ul style="list-style-type: none"> • ST70. (SeaTalk^{ng} course computer only.) • ST70+. (SeaTalk^{ng} course computer only.) • p70. • p70R. 	SeaTalk, SeaTalk ^{ng} .
7	Course computer — Raymarine	1	SeaTalk (via optional SeaTalk to SeaTalk ^{ng} converter): <ul style="list-style-type: none"> • ST1000. • ST2000. • S1000. • S1. • S2. • S3. SeaTalk ^{ng} : <ul style="list-style-type: none"> • All SPX course computers. 	SeaTalk, SeaTalk ^{ng} , or NMEA 0183.
8	AIS — Raymarine	1	<ul style="list-style-type: none"> • AIS 250. • AIS 500. • AIS 350. • AIS 650. • AIS 950 	SeaTalk ^{ng} , or NMEA 0183.
8	AIS — third-party	1	Third-party NMEA 0183-compatible AIS Class A or Class B receiver / transceiver.	NMEA 0183
9	Vessel trim tabs — third-party	1 pair	Third-party NMEA 2000 interfaces.	NMEA 2000 (via optional DeviceNet adaptor cables).
10	Video / camera	<ul style="list-style-type: none"> • New a Series = 0 • e7, e7D, New c Series = 1 • New e Series (excluding e7 and e7D) = 2 	Composite PAL or NTSC video source.	BNC connectors.
10	IP camera	Only 1 camera may be viewed at a time.	Third party IP camera	Via SeaTalk ^{hs} network.
11	Lifetag (Man overboard alert)	1 basestation	All Raymarine Lifetag basestations.	SeaTalk (via optional SeaTalk to SeaTalk ^{ng} converter)

Item	Device Type	Maximum quantity	Suitable Devices	Connections
12	Engine interface — third-party	1	Third-party NMEA 2000 interfaces.	NMEA 2000 (via optional DeviceNet adaptor cables).
13	Transducers and sensors — Raymarine	1	Analog transducers: <ul style="list-style-type: none"> • Wind. • Speed. • Depth. 	SeaTalk ^{ng} (via optional transducer pods).
13	Transducers and sensors — Airmar	1	<ul style="list-style-type: none"> • DT800 Smart Sensor. • DST800 Smart Sensor. • PB200 weather station. 	SeaTalk ^{ng} (via optional transducer pods).
14	Video out	New e Series (excluding e7 and e7D) = 1	External display.	15 pin D-Type connector (VGA Style).
15	Sonar transducer	1	<p>Direct connection to display (Sonar variant displays only):</p> <ul style="list-style-type: none"> • Raymarine P48. • Raymarine P58. • Raymarine P74. • Raymarine B60 20° • Raymarine B60 12° • Raymarine B744V <p>; OR:</p> <ul style="list-style-type: none"> • Any 600 watt / 1Kw compatible transducer (via optional E66066 adaptor cable). <p>; OR:</p> <ul style="list-style-type: none"> • Any Minn Kota transducer (via optional A62363 adaptor cable). <p>Connection via external Raymarine Sonar Module:</p> <ul style="list-style-type: none"> • Any sonar module-compatible transducer. 	Raymarine transducer connection, OR Minn Kota transducer connection.
16	VHF radio — Raymarine	1	All Raymarine DSC VHF radios.	NMEA 0183 only (No SeaTalk support).
17	Sirius Weather receiver — Raymarine (North America only)	1	<p>SeaTalk^{hs}:</p> <ul style="list-style-type: none"> • SR100. • SR6. <p>SeaTalk^{ng}:</p> <ul style="list-style-type: none"> • SR50. 	SeaTalk ^{hs} , SeaTalk ^{ng} .
18	Additional multifunction display(s) — Raymarine	5	<p>SeaTalk^{hs} (recommended):</p> <ul style="list-style-type: none"> • New a Series multifunction displays. • New c Series multifunction displays. • New e Series multifunction displays. <div style="border: 1px solid black; padding: 5px; margin: 5px 0;"> <p>Note: You can connect Raymarine multifunction displays using NMEA 0183 or SeaTalk^{ng} but not all functions are supported.</p> </div> <div style="border: 1px solid black; padding: 5px; margin: 5px 0;"> <p>Note: Visit www.raymarine.com to download the latest software version for your display.</p> </div>	SeaTalk ^{hs} .
18	Additional multifunction display(s) — third-party	<ul style="list-style-type: none"> • Connections to multifunction display NMEA outputs: 4. • Connections to multifunction display NMEA inputs: 2 	NMEA 0183-compatible chartplotters and multifunction displays.	NMEA 0183

Item	Device Type	Maximum quantity	Suitable Devices	Connections
19	Fishfinder (Sonar Module) — Raymarine	1	<ul style="list-style-type: none"> • CP450C • DSM30. • DSM300. 	SeaTalk ^{hs} .
20	Radar — Raymarine	1	<p>All Raymarine Non-HD Digital Radomes and HD or SuperHD radar scanners.</p> <div style="border: 1px solid black; padding: 2px;"> <p>Note: Please ensure your radar scanner is using the latest software version.</p> </div>	SeaTalk ^{hs} .
21	Thermal camera — Raymarine	1	<p>All Raymarine thermal cameras.</p> <div style="border: 1px solid black; padding: 2px;"> <p>Note: New a Series multifunction displays do not support thermal cameras.</p> </div>	SeaTalk ^{hs} (for control), BNC connector (for video).
22	PC / laptop	1	Windows-compatible PC or laptop running Raymarine Voyager planning software.	SeaTalk ^{hs}
	Cartography — included		Embedded (internal) Navionics world base map.	Internal storage.
	Cartography — optional		<p>External MicroSD, or MicroSDHC chart cards:</p> <ul style="list-style-type: none"> • Navionics Ready to Navigate. • Navionics Silver • Navionics Gold • Navionics Gold+ • Navionics Platinum • Navionics Platinum+ • Navionics Fish'N Chip • Navionics Hotmaps <p>Refer to the Raymarine website (www.raymarine.com) for the latest list of supported chart cards.</p>	Card slot.

3.2 Installation checklist

Installation includes the following activities:

Installation Task	
1	Plan your system.
2	Obtain all required equipment and tools.
3	Site all equipment.
4	Route all cables.
5	Drill cable and mounting holes.
6	Make all connections into equipment.
7	Secure all equipment in place.
8	Power on and test the system.

3.3 System Limits

The following limits apply to the number of system components that can be connected in a Raymarine multifunction display system.

Component	Maximum
Maximum number of SeaTalk ^{hls} devices	25
Maximum number of SeaTalk ^{ng} devices	50
New a Series / New c Series / New e Series multifunction displays	6

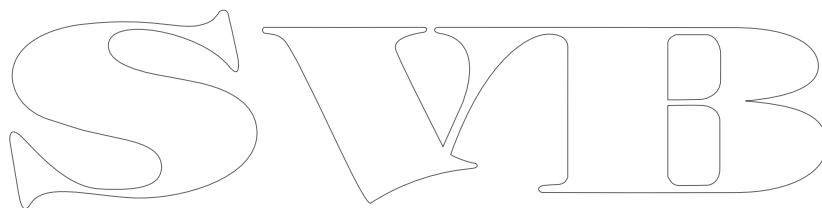
The logo consists of the letters 'S', 'V', 'I', and 'B' in a stylized, outlined font. The 'S' is a simple outline. The 'V' has a decorative, pointed bottom. The 'I' is a simple outline. The 'B' has a decorative, rounded bottom. The letters are arranged horizontally and are connected at the top.

3.4 Multiple data sources (MDS) overview

Installations that include multiple instances of data sources can cause data conflicts. An example is an installation featuring more than one source of GPS data.

MDS enables you to manage conflicts involving the following types of data:

- GPS Position.
- Heading.
- Depth.
- Speed.
- Wind.

Typically this exercise is completed as part of the initial installation, or when new equipment is added.

If this exercise is NOT completed the system will automatically attempt to resolve data conflicts. However, this may result in the system choosing a source of data that you do not want to use.

If MDS is available the system can list the available data sources and allow you to select your preferred data source. For MDS to be available all products in the system that use the data sources listed above must be MDS-compliant. The system can list any products that are NOT compliant. It may be necessary to upgrade the software for these non-compliant products to make them compliant. Visit the Raymarine website (www.raymarine.com) to obtain the latest software for your products. If MDS-compliant software is not available and you do NOT want the system to automatically attempt to resolve data conflicts, any non-compliant product(s) can be removed or replaced to ensure the entire system is MDS-compliant.

3.5 Identifying your display variant

To discover which model display you have follow the steps below:

From the homescreen:

1. Select **Set-up**.
2. Select **Maintenance**.
3. Select **Diagnostics**.
4. Select **Select Device**.
5. Search the Network column for the '**This Device**' entry.
6. The Device column for this record will list the model of your display.

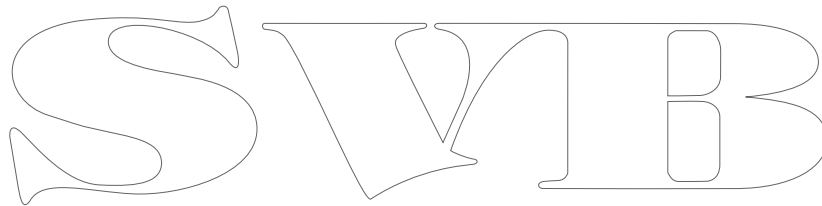

3.6 Networking constraints

New a Series, New c Series and New e Series displays can be networked together and can also be networked to Raymarine's E-Series Widescreen displays and G-Series systems. Caution is advised when networking a New a Series, New c Series or New e Series to a network containing a E-Series Widescreen display or when connecting to a G-Series system as there are networking constraints and restrictions which apply.

General

- Multifunction displays should be connected together using SeaTalk^{hs}.
- Multifunction displays can also be connected via SeaTalk^{ng} or NMEA 0183, but not all functions are supported.
- All networked New a Series, New c Series and New e Series displays must contain software version V4.xx or later.

Note: The New a Series cannot be networked using NMEA 0183.

Master / repeater operation

- Any network featuring more than 1 multifunction display must have 1 of the displays designated as the data master.
- The data master display will receive data through NMEA 0183 and / or SeaTalk^{ng}, and bridge the data over SeaTalk^{hs} to other networked displays.
- When networking a New a Series, New c Series or New e Series multifunction display to an E-Series Widescreen display or G-Series system the New a Series, New c Series or New e Series displays must be put into compatibility mode. Compatibility mode can be accessed from the Set-up Menu from the homescreen: **Set-up > Maintenance > Compatibility**.
- Any network containing a G-Series system must have the G-Series (GPM400) set as the data master.

Note: Connected E-Series Widescreen displays and G-Series system will reset once compatibility mode has been selected.

Legacy multifunction display support (E-Series Widescreen and G-Series system)

- A G-Series (GPM400) system operating with software version V4.xx or later will permit the connection of up to 2 New a Series, New c Series or New e Series displays or 2 E-Series Widescreen displays or 1 of each (e.g. 1 New e Series and 1 E-Series Widescreen display).

Note: Master / repeater operation applies.

- A network featuring a New a Series, New c Series or New e Series displays and either an E-Series Widescreen or G-Series system must be connected using SeaTalk^{hs} only.

An incompatibility message is displayed on-screen when a multifunction display is connected which is not supported.

Homescreen sharing

- When networked, New a Series, New c Series or New e Series displays can share homescreens.
- New a Series, New c Series and New e Series cannot share homescreens with an E-Series Widescreen display or G-Series system.

Cartography sharing

- The cartography contained on chart cards is always used in preference to embedded cartography when a chart card is inserted into a card slot.
- Chart card cartography can be shared between New a series, New c Series, New e Series, E-Series Widescreen and G-Series systems.

Radar operation

- New a Series, New c Series or New e Series systems support the use of 1 radar scanner at a time.

- The data supplied by a connected radar scanner is repeated to any networked displays.

Sonar operation

- You can connect an external sonar module unit to New a Series, New c Series or New e Series displays via SeaTalk^{hs} / RayNet.
- a67, e7D, e97, e127, c97, c127 models include a 600 W built-in sonar module and the display can be directly connected to a compatible sonar transducer.
- If connecting an external sonar module unit to a a67, e7D, e97, e127, c97 or c127 then the internal sonar must be switched off. From the fishfinder application goto **Menu > Set-up > Sounder Set-up > Internal Sounder > Off**.
- You can only use 1 sonar transducer at any one time.
- The data supplied by an internal or external sonar module is repeated to any networked displays.

3.7 Typical systems

The illustrations below show examples of possible system configurations, for more details on compatible devices please refer to the *System integration* section.

Note: In the examples below the multifunction display(s) could be any of the following:

- New a Series
- New c Series
- New e Series

Example: Basic system

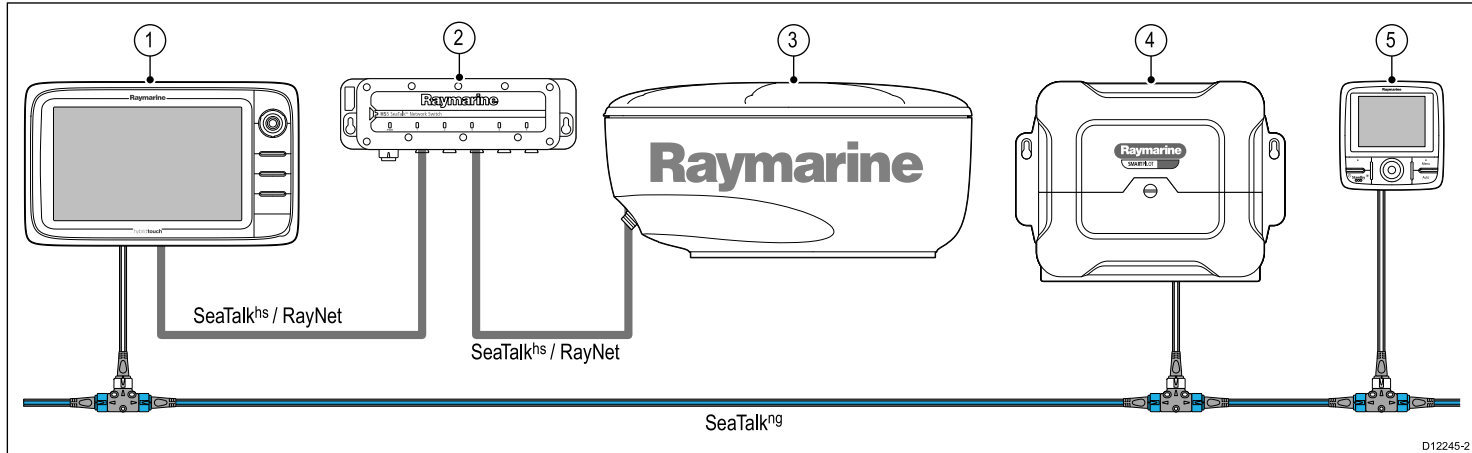

1. Raymarine Multifunction display.
2. Raymarine network switch.
3. Raymarine radar scanner.
4. SPX course computer.
5. SeaTalkng Pilot controller.

Note: A network switch is only required if multiple devices are connected using SeaTalkhs / RayNet.

Example: Basic system with SeaTalk equipment

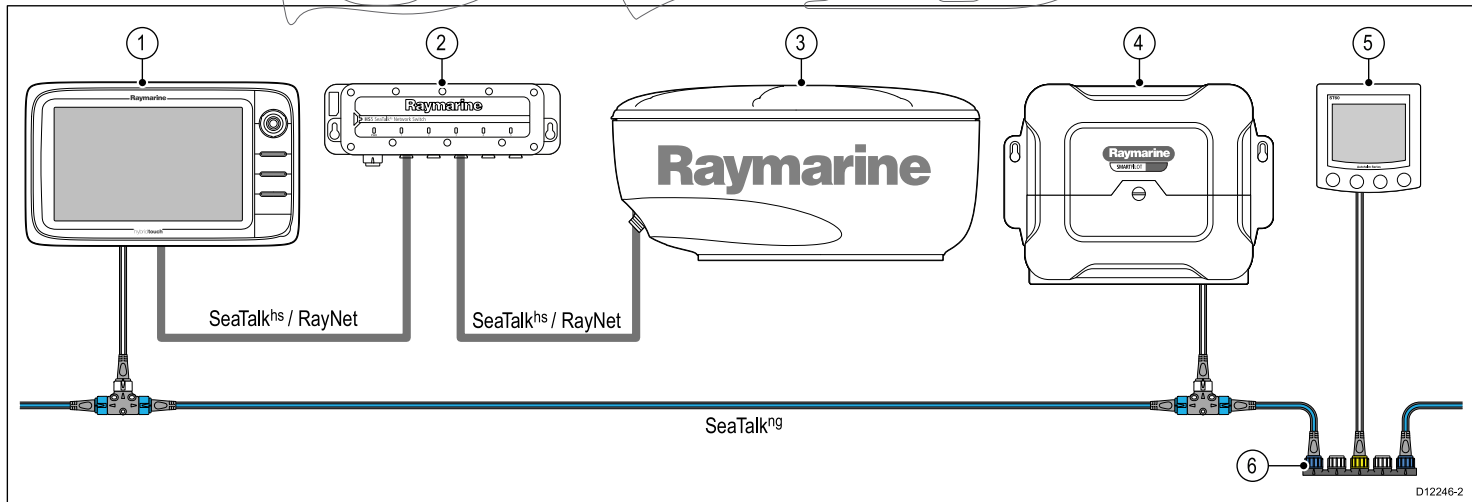

1. Multifunction display
2. Network switch.
3. Radar scanner.
4. SPX course computer.
5. SeaTalk pilot controller.
6. SeaTalk to SeaTalkng converter.

Note: A network switch is only required if more than one device is connected using SeaTalkhs / RayNet.

Example: Basic system with sonar variant display

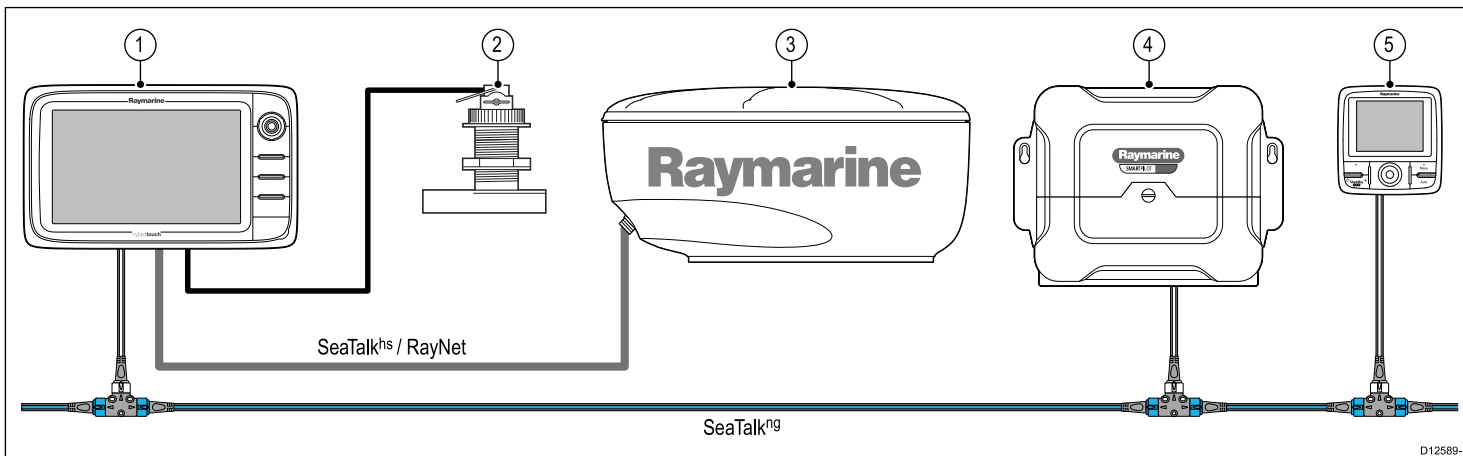

D12589-1

1. Multifunction display
2. Sonar transducer.
3. Radar scanner.
4. SPX course computer.
5. SeaTalk^{ng} pilot controller.

Example: Basic system with non-sonar variant display

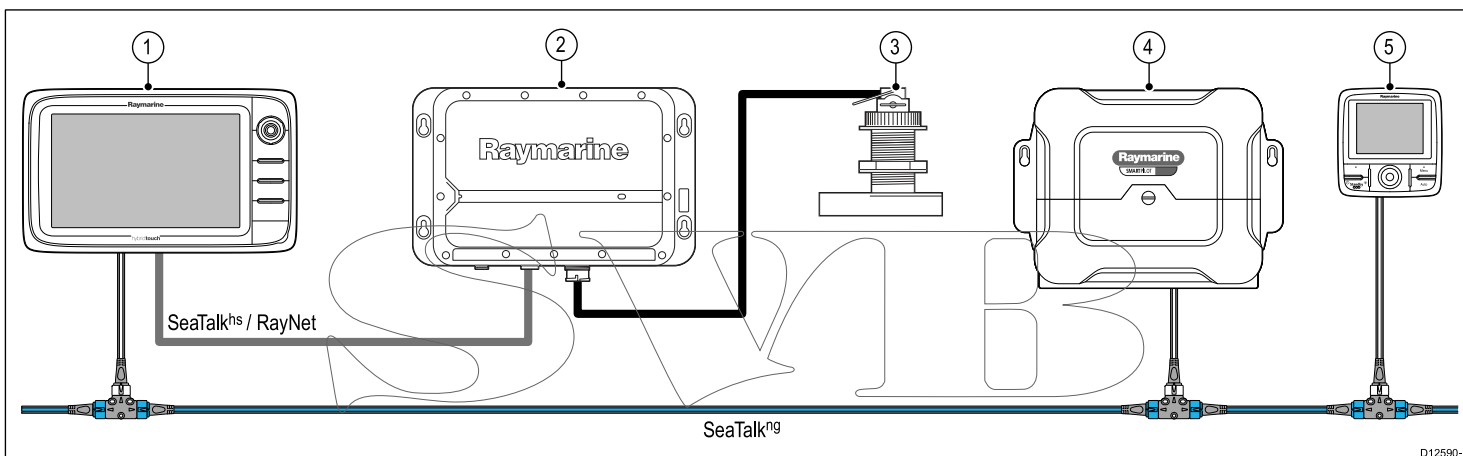

D12590-1

1. Multifunction display.
2. Sonar module.
3. Sonar transducer.
4. SPX course computer.
5. SeaTalk^{ng} pilot controller.

Example: Expanded system

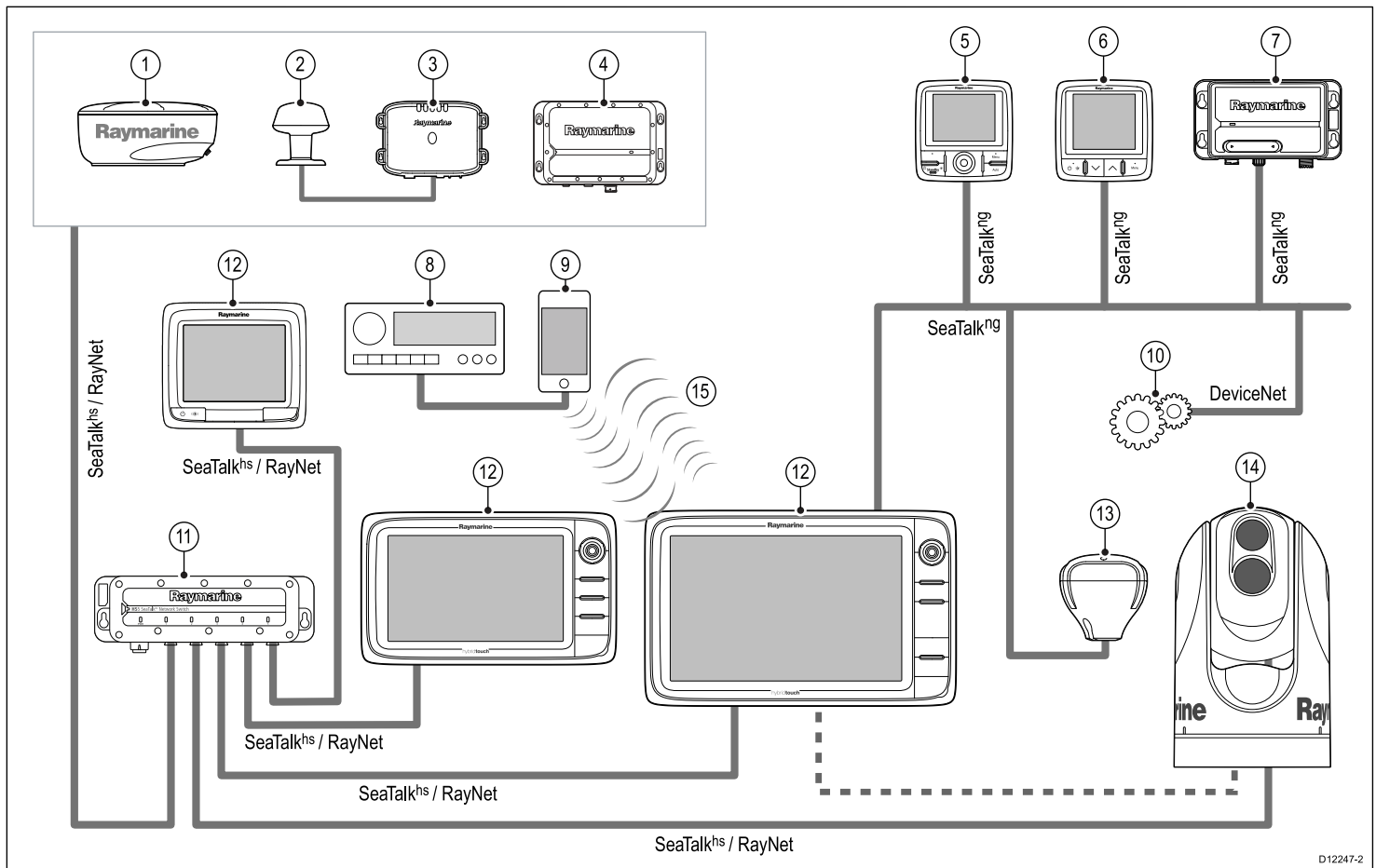

D12247-2

1. Radar scanner.
2. Weather sensor.
3. Sirius weather receiver.
4. Sonar module.
5. SeaTalk^{ng} Pilot controller.
6. SeaTalk^{ng} Instrument display.
7. AIS receiver / transceiver.
8. Audio system.
9. Smartphone / tablet.
10. DeviceNet spur (for NMEA 2000 devices).
11. Network switch.
12. Multifunction display.
13. GPS receiver.
14. Thermal camera.
15. Wireless connection.

SVIB

3.8 System protocols

Your Multifunction Display can connect to various instruments and displays to share information and so improve the functionality of the system. These connections may be made using a number of different protocols. Fast and accurate data collection and transfer is achieved by using a combination of the following data protocols:

- SeaTalk^{hs}
- SeaTalk^{ng}
- NMEA 2000
- SeaTalk
- NMEA 0183

Note: You may find that your system does not use all of the connection types or instrumentation described in this section.

SeaTalk^{hs}

SeaTalk^{hs} is an ethernet based marine network. This high speed protocol allows compatible equipment to communicate rapidly and share large amounts of data.

Information shared using the SeaTalk^{hs} network includes:

- Shared cartography (between compatible displays).
- Digital radar data.
- Sonar data.

Seata^{ng}

SeaTalk^{ng} (Next Generation) is an enhanced protocol for connection of compatible marine instruments and equipment. It replaces the older SeaTalk and SeaTalk² protocols.

SeaTalk^{ng} utilizes a single backbone to which compatible instruments connect using a spur. Data and power are carried within the backbone. Devices that have a low draw can be powered from the network, although high current equipment will need to have a separate power connection.

SeaTalk^{ng} is a proprietary extension to NMEA 2000 and the proven CAN bus technology. Compatible NMEA 2000 and SeaTalk / SeaTalk² devices can also be connected using the appropriate interfaces or adaptor cables as required.

NMEA 2000

NMEA 2000 offers significant improvements over NMEA 0183, most notably in speed and connectivity. Up to 50 units can simultaneously transmit and receive on a single physical bus at any one time, with each node being physically addressable. The standard was specifically intended to allow for a whole network of marine electronics from any manufacturer to communicate on a common bus via standardized message types and formats.

SeaTalk

SeaTalk is a protocol which enables compatible instruments to connect to each other and share data.

The SeaTalk cable system is used to connect compatible instruments and equipment. The cable carries power and data and enables connection without the need for a central processor.

Additional instruments and functions can be added to a SeaTalk system, simply by plugging them into the network. SeaTalk equipment can also communicate with other non-SeaTalk equipment via the NMEA 0183 standard, provided a suitable interface is used.

NMEA 0183

The NMEA 0183 Data Interface Standard was developed by the National Marine Electronics Association of America. It is an international standard to enable equipment from many different manufacturers to be connected together and share information.

The NMEA 0183 standard carries similar information to SeaTalk. However it has the important difference that one cable will only carry information in one direction. For this reason NMEA 0183 is generally used to connect a data receiver and a transmitter together, e.g. a compass sensor transmitting heading to a radar display. This

information is passed in 'sentences', each of which has a three letter sentence identifier. It is therefore important when checking compatibility between items that the same sentence identifiers are used some examples of which are:

- VTG - carries Course and Speed Over Ground data.
- GLL - carries latitude and longitude.
- DBT - carries water depth.
- MWV - carries relative wind angle and wind speed data.

NMEA Baud rates

The NMEA 0183 standard operates at a number of different speeds, depending upon the particular requirement or equipment capabilities. Typical examples are:

- 4800 baud rate. Used for general purpose communications, including FastHeading data.
- 38400 baud rate. Used for AIS and other high speed applications.

3.9 Data master

Any system containing more than one networked multifunction display must have a designated data master.

The data master is the display which serves as a primary source of data for all displays, it also handles all external sources of information. For example the displays may require heading information from the autopilot and GPS systems, usually received through a SeaTalk^{ng} or NMEA connection. The data master is the display to which the SeaTalk, NMEA and any other data connections are made, it then bridges the data to the SeaTalk^{hs} network and any compatible repeat displays. Information shared by the data master includes:

- Cartography
- Routes and waypoints
- Radar
- Sonar
- Data received from the autopilot, instruments, the engine and other external sources.

Your system may be wired for redundancy with data connections made to repeat displays. However these connections will only become active in the event of a fault and/or reassignment of the data master.

3.10 New a Series parts supplied

The following items are supplied with your a65 / a67 multifunction display.

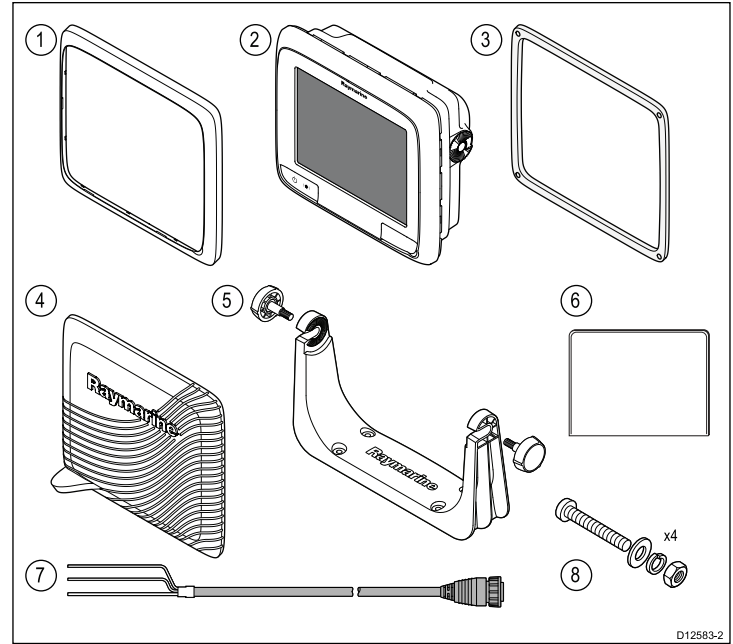

1	Front bezel
2	Multifunction display
3	Flush mount gasket
4	Sun cover
5	Trunion bracket kit
6	Documentation pack
7	Power cable
8	4x Nuts, bolts, spring washers and washers (can be used for either flush or bracket mounting.)

SV

3.11 e7 / e7D Parts supplied

The parts shown below are supplied with the e7 / e7D multifunction display.

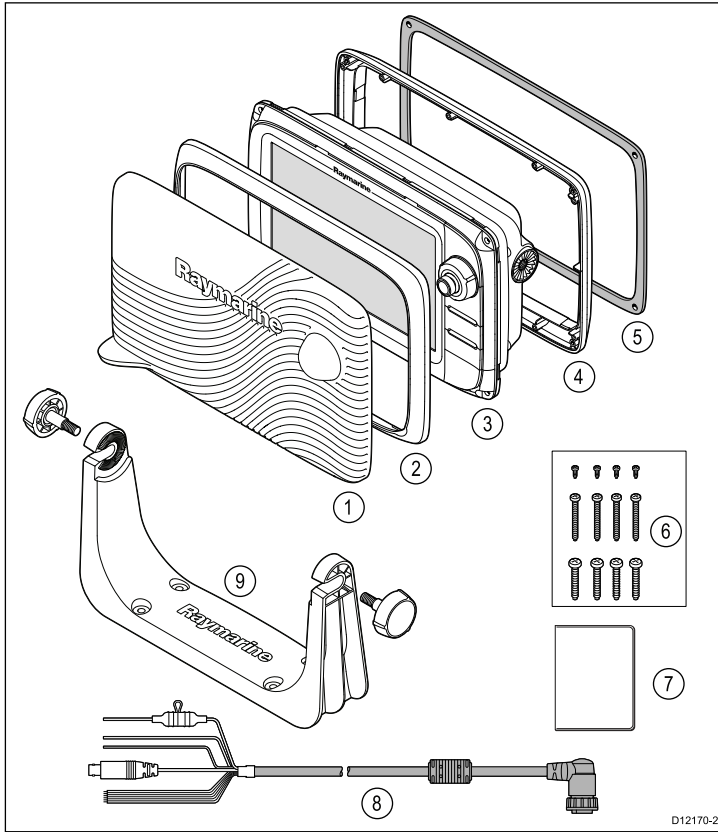

1. Sun cover.
2. Front bezel.
3. Multifunction display.
4. Rear bezel (required for trunnion bracket mounting).
5. Gasket (required for flush mounting).
6. Screw pack, includes:
 - 4 x rear bezel fixing screws.
 - 4 x unit mounting screws (for flush mounting).
 - 4 x unit mounting screws (for trunnion bracket mounting).
7. Documentation pack, includes:
 - Multilingual CD.
 - Mounting and getting started multilingual guide
 - Mounting template.
 - Warranty policy
8. Power and data cable.
9. Trunnion bracket kit.

3.12 New c Series and New e Series parts supplied

The parts shown below are supplied with the New c Series and New e Series (Excluding e7 and e7D) multifunction displays.

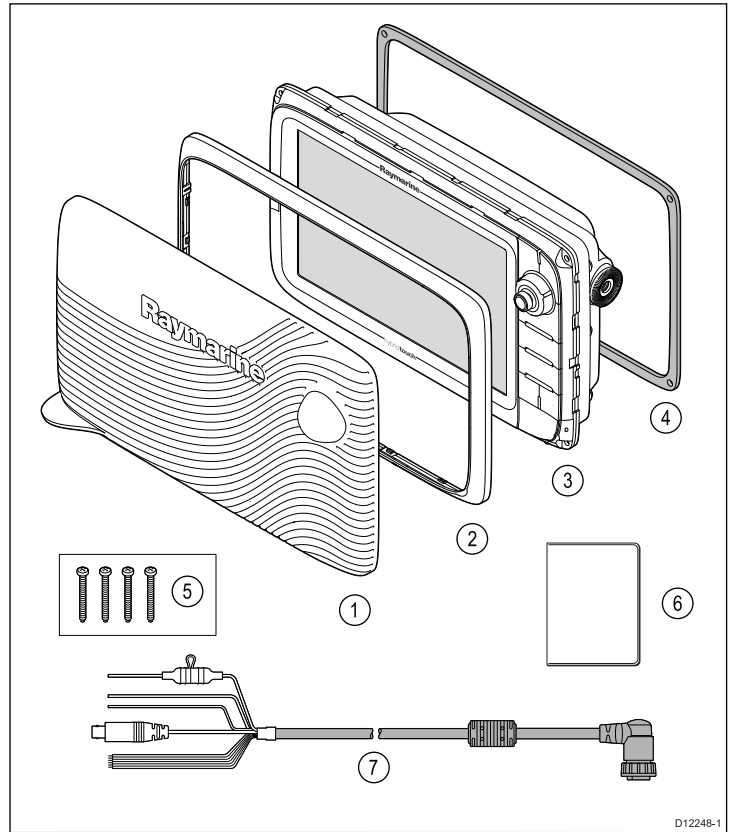

1. Sun cover.
2. Front bezel.
3. Multifunction display.
4. Gasket (required for flush mounting).
5. Screw pack, includes 4 x unit mounting screws (for flush mounting).
6. Documentation pack, includes:
 - Multilingual CD.
 - Mounting and getting started multilingual guide
 - Mounting template.
 - Warranty policy
7. Power and data cable.

3.13 Tools required for installation

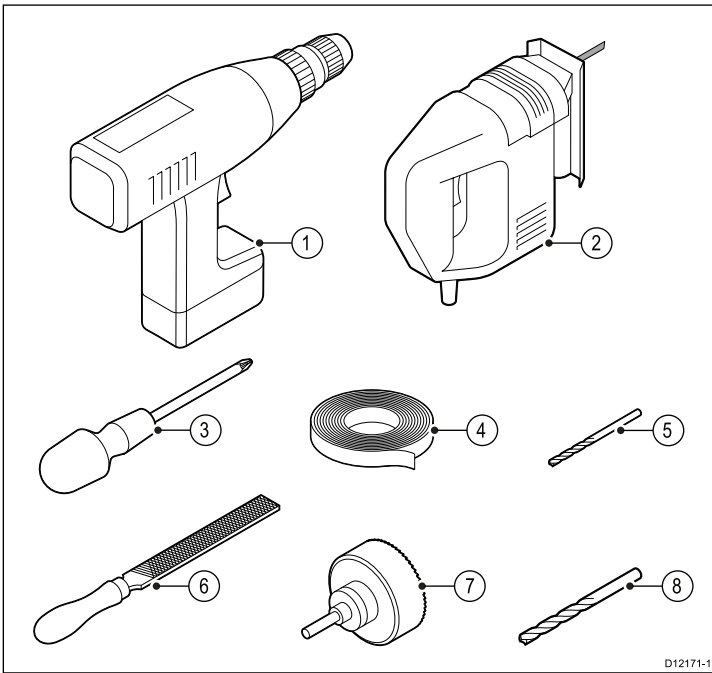

1. Power drill.
2. Jigsaw.
3. Pozidrive screwdriver.
4. Adhesive tape.
5. Drill bit for trunnion bracket mounting.
6. File.
7. Hole saw for flush mounting (For hole saw size refer to your product's mounting template).
8. Drill bit for flush mounting.

SVIB

SWIB

Chapter 4: Cables and connections

Chapter contents

- [4.1 General cabling guidance on page 38](#)
- [4.2 Connections overview on page 39](#)
- [4.3 Power connection — New a Series on page 40](#)
- [4.4 Power connection — New c Series and New e Series on page 41](#)
- [4.5 Network connections on page 43](#)
- [4.6 GPS connection on page 49](#)
- [4.7 AIS connection on page 49](#)
- [4.8 Fastheading connection on page 50](#)
- [4.9 SeaTalk^{ng} connections on page 50](#)
- [4.10 SeaTalk connection on page 52](#)
- [4.11 NMEA 0183 connection on page 52](#)
- [4.12 NMEA 2000 connection on page 53](#)
- [4.13 Camera / Video connection on page 54](#)
- [4.14 Camera / video in-out connection on page 54](#)
- [4.15 Bluetooth connections on page 55](#)
- [4.16 WiFi connections on page 56](#)

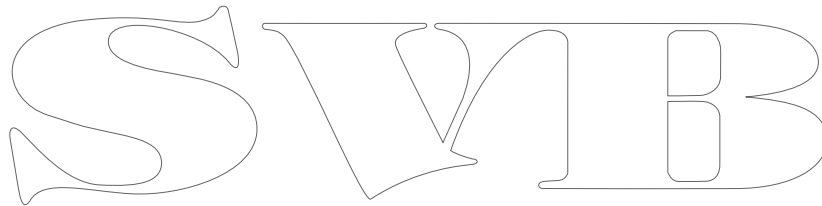

4.1 General cabling guidance

Cable types and length

It is important to use cables of the appropriate type and length

- Unless otherwise stated use only standard cables of the correct type, supplied by Raymarine.
- Ensure that any non-Raymarine cables are of the correct quality and gauge. For example, longer power cable runs may require larger wire gauges to minimize voltage drop along the run.

Routing cables

Cables must be routed correctly, to maximize performance and prolong cable life.

- Do NOT bend cables excessively. Wherever possible, ensure a minimum bend diameter of 200 mm (8 in) / minimum bend radius of 100 mm (4 in).

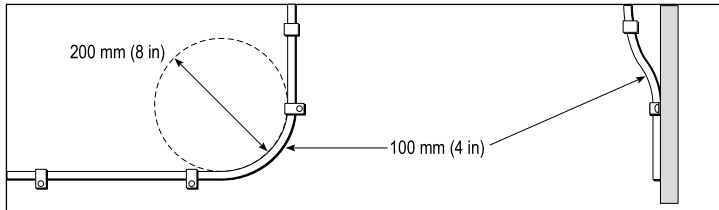

- Protect all cables from physical damage and exposure to heat. Use trunking or conduit where possible. Do NOT run cables through bilges or doorways, or close to moving or hot objects.
- Secure cables in place using tie-wraps or lacing twine. Coil any extra cable and tie it out of the way.
- Where a cable passes through an exposed bulkhead or deckhead, use a suitable watertight feed-through.
- Do NOT run cables near to engines or fluorescent lights.

Always route data cables as far away as possible from:

- other equipment and cables.
- high current carrying ac and dc power lines.
- antennae.

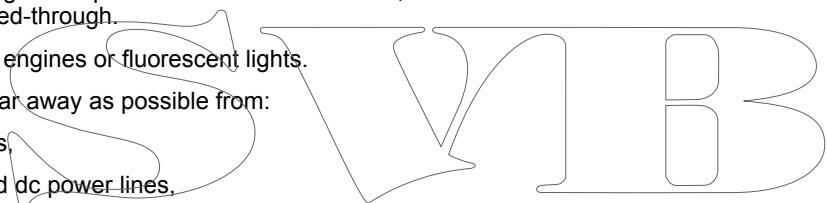

Strain relief

Ensure adequate strain relief is provided. Protect connectors from strain and ensure they will not pull out under extreme sea conditions.

Circuit isolation

Appropriate circuit isolation is required for installations using both AC and DC current:

- Always use isolating transformers or a separate power-inverter to run PC's, processors, displays and other sensitive electronic instruments or devices.
- Always use an isolating transformer with Weather FAX audio cables.
- Always use an isolated power supply when using a 3rd party audio amplifier.
- Always use an RS232/NMEA converter with optical isolation on the signal lines.
- Always make sure that PC's or other sensitive electronic devices have a dedicated power circuit.

Cable shielding

Ensure that all data cables are properly shielded that the cable shielding is intact (e.g. hasn't been scraped off by being squeezed through a tight area).

4.2 Connections overview

Details of the connections available on Raymarine multifunction displays are shown below.

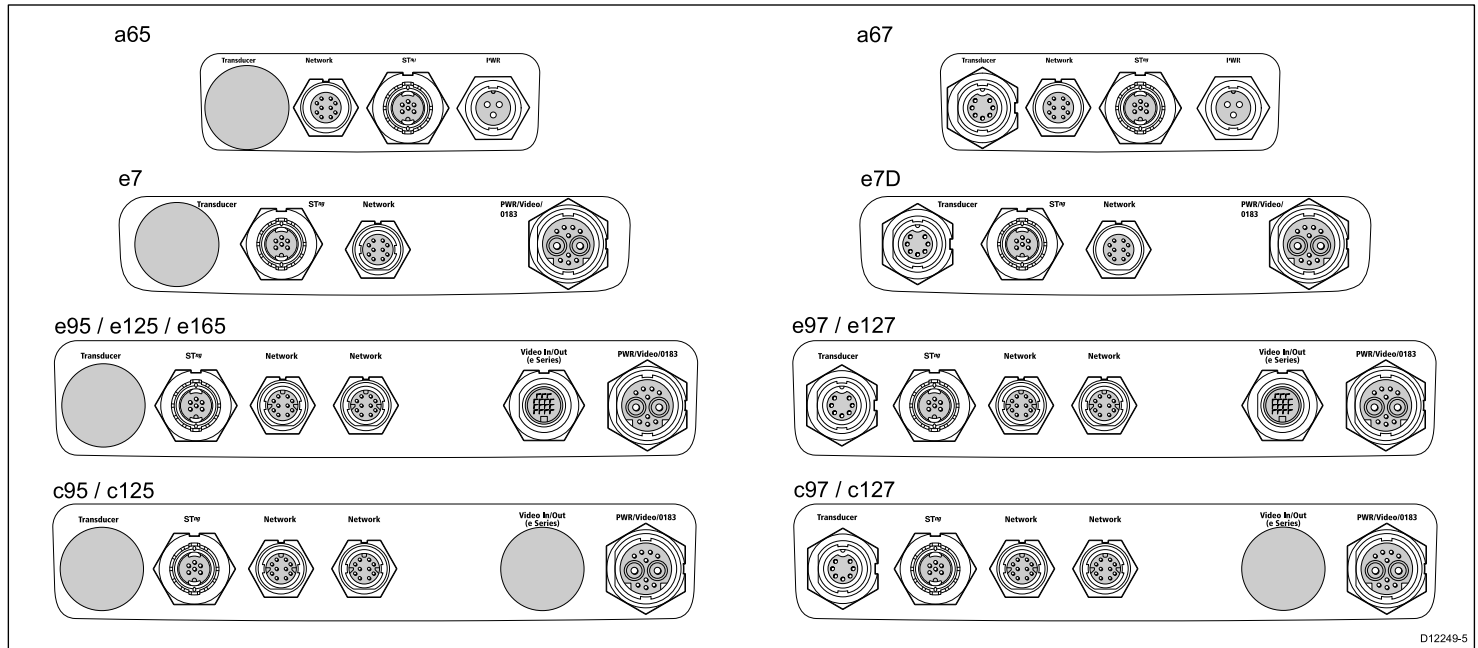

D12248-5

	Transducer	SeaTalk ^{ng}	SeaTalk ^{hs} / RayNet Network 1	SeaTalk ^{hs} / RayNet Network 2	Video in / out	Power / Video / NMEA 0183
a65	✗	✓	✓	✗	✗	✓
a67	✓	✓	✓	✗	✗	✓
e7	✗	✓	✓	✗	✗	✓
e7D	✓	✓	✓	✗	✗	✓
e95	✗	✓	✓	✓	✓	✓
e97	✓	✓	✓	✓	✓	✓
e125	✗	✓	✓	✓	✓	✓
e127	✓	✓	✓	✓	✓	✓
e165	✗	✓	✓	✓	✓	✓
c95	✗	✓	✓	✓	✗	✓
c97	✓	✓	✓	✓	✗	✓
c125	✗	✓	✓	✓	✗	✓
c127	✓	✓	✓	✓	✗	✓

4.3 Power connection — New a Series

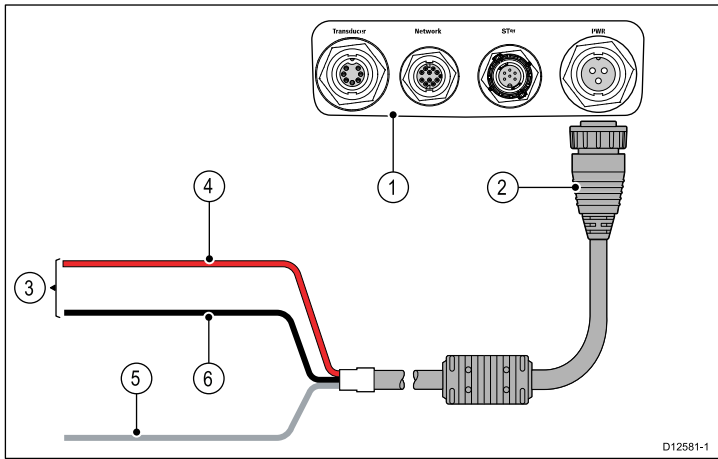

1. Multifunction display rear panel connections.
2. Power cable.
3. Connection to 12 V power supply
4. Red cable (positive).
5. Shield (drain) wire (thin black wire; must be connected to RF ground point).
6. Black cable (negative).

Power distribution

Raymarine recommends that all power connections are made via a distribution panel.

- All equipment must be powered from a breaker or switch, with appropriate circuit protection.
- All equipment should be wired to individual breakers if possible.



Warning: Product grounding

Before applying power to this product, ensure it has been correctly grounded, in accordance with the instructions in this guide.

Grounding — Dedicated drain wire

The power cable supplied with this product includes a dedicated shield (drain) wire for connection to a vessel's RF ground point.

It is important that an effective RF ground is connected to the system. A single ground point should be used for all equipment. The unit can be grounded by connecting the shield (drain) wire of the power cable to the vessel's RF ground point. On vessels without an RF ground system the shield (drain) wire should be connected directly to the negative battery terminal.

The dc power system should be either:

- Negative grounded, with the negative battery terminal connected to the vessel's ground.
- Floating, with neither battery terminal connected to the vessel's ground



Warning: Positive ground systems

Do not connect this unit to a system which has positive grounding.

Power cable

The display is supplied with a power cable, this can be extended if required..

Power cables available

For flush mount installations a right angled power cable (not supplied) is available.

Cable	Part number	Notes
Right angled power cable	A80021	

Cable extension

The following restrictions apply to any extension to the power cable:

- Cable must be of a suitable gauge for the circuit load.
- Each unit should have its own dedicated power cable wired back to the distribution panel.

Total length (max)	Supply voltage	Cable gauge (AWG)
0–5 m (0–16.4 ft)	12 V	18
5–10 m (16.4–32.8 ft)	12 V	14
10–15 m (32.8–49.2 ft)	12 V	12
15–20 m (49.2–65.5 ft)	12 V	12

Note: These distances are for a 2 wire power cable run from the battery to the display (approximately the distance from the battery to the display). To calculate the round trip length, double the figure stated here.

Breakers, fuses and circuit protection

The unit includes an internal fuse. It is recommended that you fit an additional thermal breaker or fuse at the distribution panel.

Thermal breaker rating

5 A (if only connecting one device)

Note: The suitable fuse rating for the thermal breaker is dependent on the number of devices you are connecting. If in doubt consult an authorized Raymarine dealer.

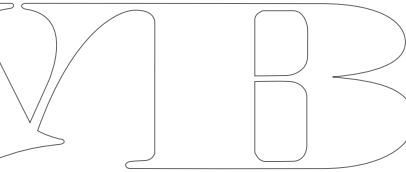

4.4 Power connection — New c Series and New e Series

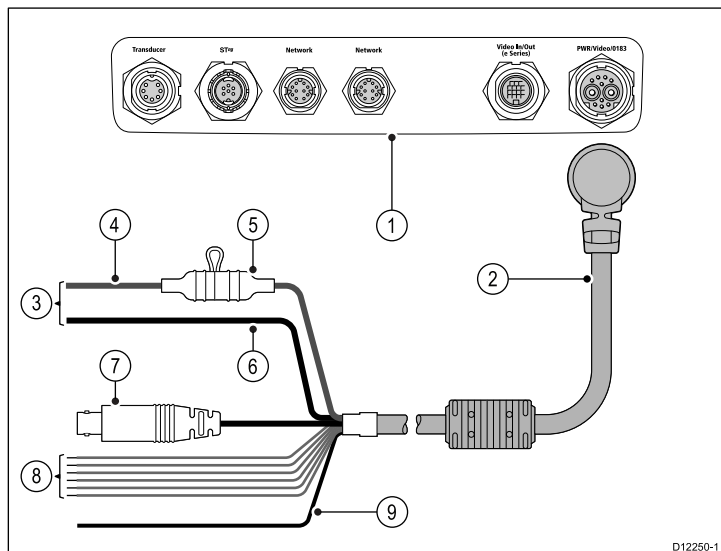

1. Multifunction display connections.
2. Power and data cable.
3. Connection to 12/24 V power supply (e7/e7D is 12V only).
4. Red cable (positive).
5. Fuse.
6. Black cable (negative).
7. Video input cable.
8. NMEA 0183 data cables.
9. Shield (drain) wire (thin black wire; must be connected to RF ground point).

Power distribution

Raymarine recommends that all power connections are made via a distribution panel.

- All equipment must be powered from a breaker or switch, with appropriate circuit protection.
- All equipment should be wired to individual breakers if possible.



Warning: Product grounding

Before applying power to this product, ensure it has been correctly grounded, in accordance with the instructions in this guide.

Grounding — Dedicated drain wire

The power cable supplied with this product includes a dedicated shield (drain) wire for connection to a vessel's RF ground point.

It is important that an effective RF ground is connected to the system. A single ground point should be used for all equipment. The unit can be grounded by connecting the shield (drain) wire of the power cable to the vessel's RF ground point. On vessels without an RF ground system the shield (drain) wire should be connected directly to the negative battery terminal.

The dc power system should be either:

- Negative grounded, with the negative battery terminal connected to the vessel's ground.
- Floating, with neither battery terminal connected to the vessel's ground



Warning: Positive ground systems

Do not connect this unit to a system which has positive grounding.

Power cable

The display is supplied with a combined power and data multi cable, this can be extended if required.

Power cables available

Cable	Part number	Notes
1.5 m (4.9 ft) Straight power and data cable	R62379	
1.5 m (4.9 ft) Right angled power and data cable	R70029	

Cable extension

The following restrictions apply to any extension to the power cable:

- Cable must be of a suitable gauge for the circuit load.
- Each unit should have its own dedicated power cable wired back to the distribution panel.

Total length (max)	Supply voltage	Cable gauge (AWG)
0–5 m (0–16.4 ft)	12 V	18
	24 V	20
5–10 m (16.4–32.8 ft)	12 V	14
	24 V	18
10–15 m (32.8–49.2 ft)	12 V	12
	24 V	16
15–20 m (49.2–65.5 ft)	12 V	12
	24 V	14

Note: These distances are for a 2 wire power cable run from the battery to the display (approximately the distance from the battery to the display). To calculate the round trip length, double the figure stated here.

Breakers, fuses and circuit protection

The power cable includes an in-line fuse. It is recommended that you fit an additional thermal breaker or fuse at the distribution panel.

Fuse rating	Thermal breaker rating
7 A in-line fuse fitted within power cable.	5 A (if only connecting one device)

Note: The suitable fuse rating for the thermal breaker is dependent on the number of devices you are connecting. If in doubt consult an authorised Raymarine dealer.

Sharing a breaker

Where more than 1 piece of equipment shares a breaker you must provide protection for the individual circuits. E.g. by connecting an in-line fuse for each power circuit.

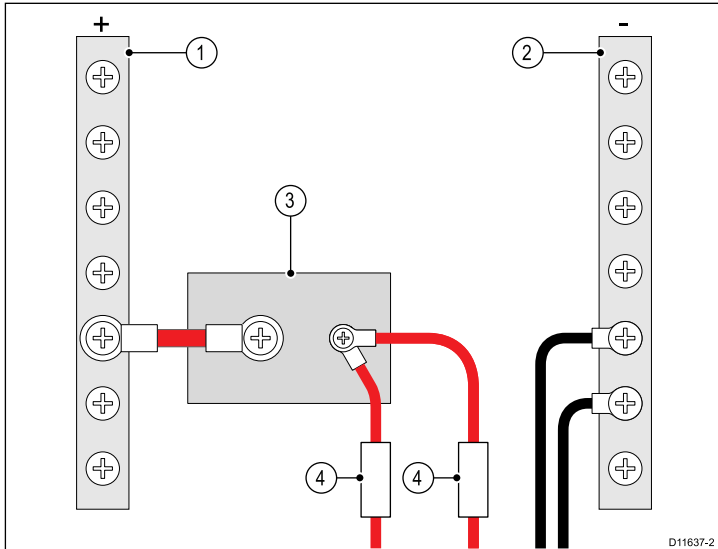

1	Positive (+) bar
2	Negative (-) bar
3	Circuit breaker
4	Fuse

Where possible, connect individual items of equipment to individual circuit breakers. Where this is not possible, use individual in-line fuses to provide the necessary protection.

SWIB

4.5 Network connections

You can connect a number of digital devices to your multifunction display using the Network connector(s) at the rear of the unit.

A typical network of digital devices may include:

- Up to 6 Raymarine multifunction displays.
- SeaTalk^{hs} or RayNet digital devices such as a sonar module and radar scanner.
- Ethernet IP cameras.

Note: Your multifunction display includes the following network connectors:

- e7, e7D, a65 and a67 = 1 x SeaTalk^{hs} / RayNet connector.
- New c Series and New e Series (excluding the e7 and e7D) = 2 x SeaTalk^{hs} / RayNet connectors.

Networks requiring additional network connections will require a Raymarine network switch.

Typical SeaTalk^{hs} network

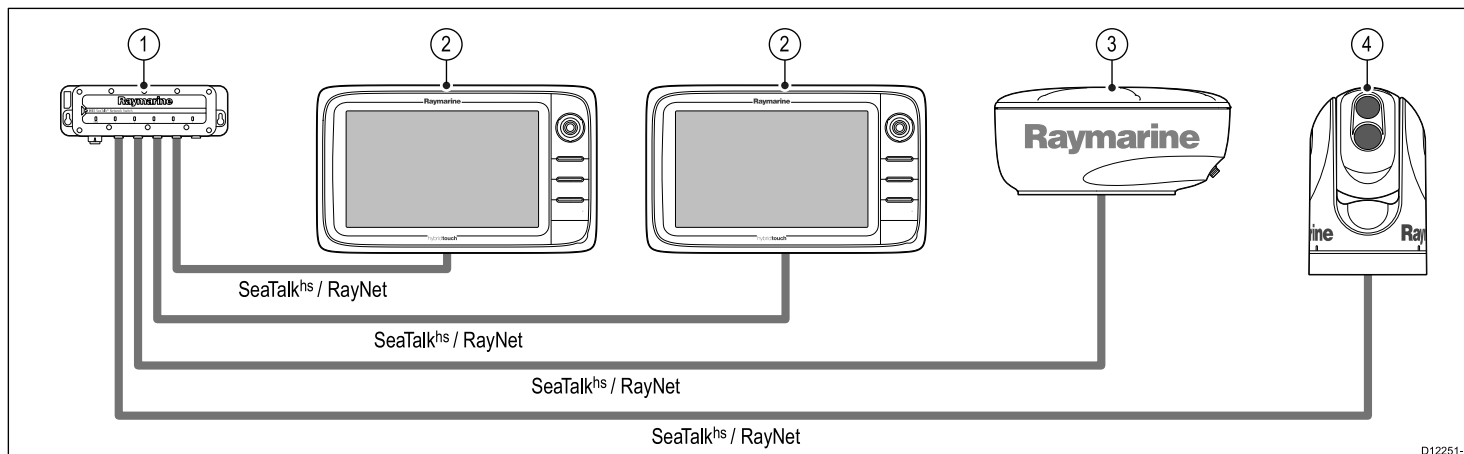

1. Raymarine network switch.
2. Multifunction display.
3. Raymarine radar scanner.
4. Thermal camera.

Note: New a Series displays do not support connection to a thermal camera.

Network hardware

Item	Part number	Notes
HS5 SeaTalk ^{hs} network switch	A80007	5-port switch for network connection of multiple SeaTalk ^{hs} devices featuring RayNet connectors. Equipment with SeaTalk ^{hs} connectors can also be connected via suitable adaptor cables.
SeaTalk ^{hs} network switch	E55058	8-port switch for network connection of multiple SeaTalk ^{hs} devices.

Item	Part number	Notes
SeaTalk ^{hs} crossover coupler	E55060	Enables direct connection of SeaTalk ^{hs} devices to smaller systems where a switch is not required. Also enables the connection of SeaTalk ^{hs} devices to an HS5 SeaTalk ^{hs} network switch (in conjunction with a RayNet to RJ45 cable).
Ethernet Coupler	R32142	Enables direct connection of ethernet or SeaTalk ^{hs} devices to smaller systems where a switch is not required. Also enables the connection of ethernet or SeaTalk ^{hs} devices to an HS5 SeaTalk ^{hs} network switch (in conjunction with a RayNet to RJ45 cable).

Network cable connector types

There are 2 types of network cable connector — SeaTalk^{hs} and RayNet.

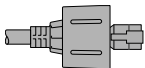
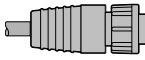
	SeaTalk^{hs} connector — used for connecting SeaTalk ^{hs} devices to a Raymarine network switch via SeaTalk ^{hs} cables.
	RayNet connector — used for connecting Raymarine network switches and SeaTalk ^{hs} devices to the multifunction display via RayNet cables. Also required for connecting a crossover coupler if only one device is being connected to the display's Network connector.

Network cable types

There are 2 types of SeaTalk^{hs} network cable — “patch” and “network”.

- **Patch** — for connecting the following devices to a Raymarine network switch:
 - Thermal camera via PoE injector.
 - Additional Raymarine network switch.
 - PC or laptop using Voyager planning software.
- **Network** — for connecting the following devices to a Raymarine network switch:
 - Sonar Module.
 - SR100 Sirius weather receiver.
 - Additional compatible Raymarine multifunction displays.

RayNet connector network cables

Cable	Part number
1 m (3.28 ft) RayNet to SeaTalk ^{hs} (RJ45) cable	A62360
3 m (9.84 ft) RayNet to SeaTalk ^{hs} (RJ45) cable	A80151
10 m (32.8 ft) RayNet to SeaTalk ^{hs} (RJ45) cable	A80159
400 mm (1.3 ft) RayNet to RayNet cable	A80160
2 m (6.56 ft) RayNet to RayNet cable	A62361
5 m (16.4 ft) RayNet to RayNet cable	A80005
10 m (32.8 ft) RayNet to RayNet cable	A62362
20 m (65.6 ft) RayNet to RayNet cable	A80006
50 mm (1.97 in) RayNet (male) to RayNet (male) cable	A80162
400 mm (1.3 ft) RayNet to SeaTalk ^{hs} (female) adaptor	A80160
RayNet cable puller 5 pack	R70014

SeaTalk^{hs} network cables

Cable	Part number
1.5 m (4.9 ft) SeaTalk ^{hs} network cable	E55049
5 m (16.4 ft) SeaTalk ^{hs} network cable	E55050
10 m (32.8 ft) SeaTalk ^{hs} network cable	E55051
20 m (65.6 ft) SeaTalk ^{hs} network cable	E55052

SeaTalk^{hs} patch cables

Cable	Part number
1.5 m (4.9 ft) SeaTalk ^{hs} patch cable	E06054
5 m (16.4 ft) SeaTalk ^{hs} patch cable	E06055

Cable	Part number
10 m (32.8 ft) SeaTalk ^{hs} patch cable	E06056
15 m (49.2 ft) SeaTalk ^{hs} patch cable	A62136
20 m (65.6 ft) SeaTalk ^{hs} patch cable	E06057

Radar connection

The multifunction display is compatible with Raymarine Non-HD digital radomes and HD / SuperHD radar scanners. The scanner is connected using a SeaTalk^{hs} cable.

Note:

- New c Series and New e Series displays (excluding the e7 and e7D) can connect 2 SeaTalk^{hs} / RayNet devices directly to the display.
- New a Series and the e7 / e7D displays can connect 1 SeaTalk^{hs} / RayNet device directly to the display.

The radar is usually connected via a Raymarine network switch. On smaller systems (with only one display and no other digital devices) the radar may be connected to the display directly using a SeaTalk^{hs} crossover coupler.

Radar connected using Raymarine network switch

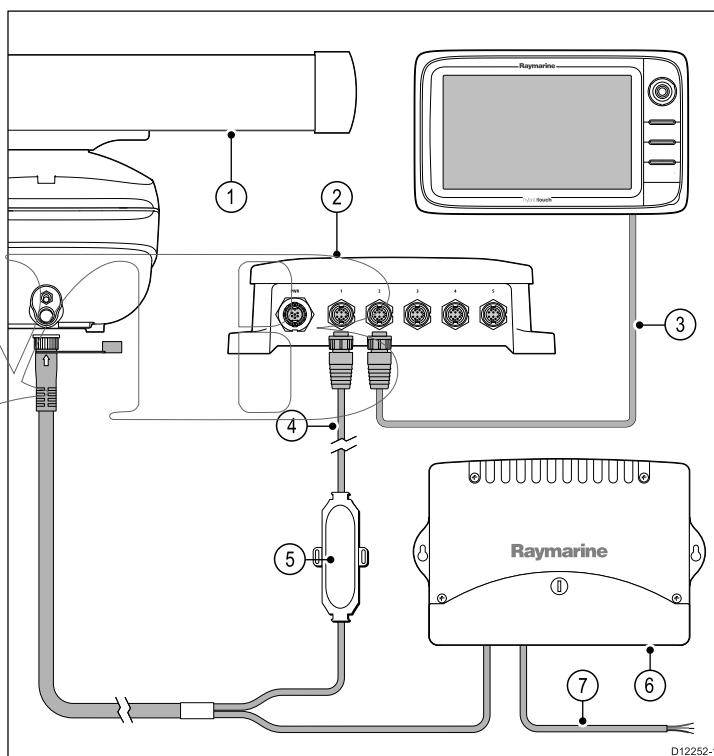

1. Radar scanner.
2. Raymarine network switch.
3. RayNet cable.
4. RayNet to SeaTalk^{hs} network cable.
5. SeaTalk^{hs} crossover coupler
6. VCM (Voltage Converter Module) — **required for Open Arrays.**
7. Power connection.

Radars connected using crossover coupler

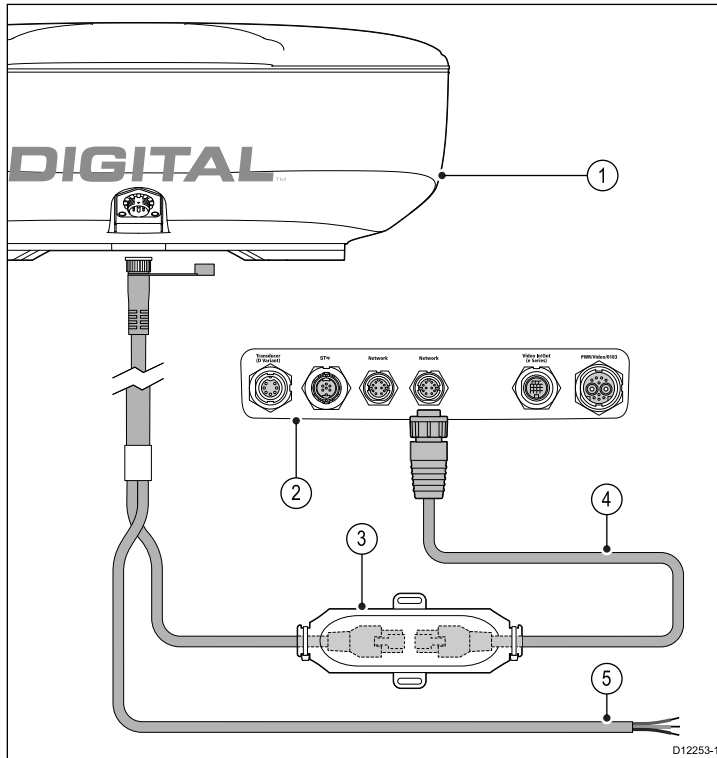

1. Radar scanner
2. Multifunction display rear connector panel.
3. SeaTalk^{hs} crossover coupler.
4. RayNet to SeaTalk^{hs} network cable.
5. Connection to power supply — **Open array scanners require a VCM (Voltage Converter Module).**

Note: The connector on the free end of the radar cable does NOT have a locking mechanism.

Radars cable extension

For longer cable runs a radar power and data digital cable extension is required.

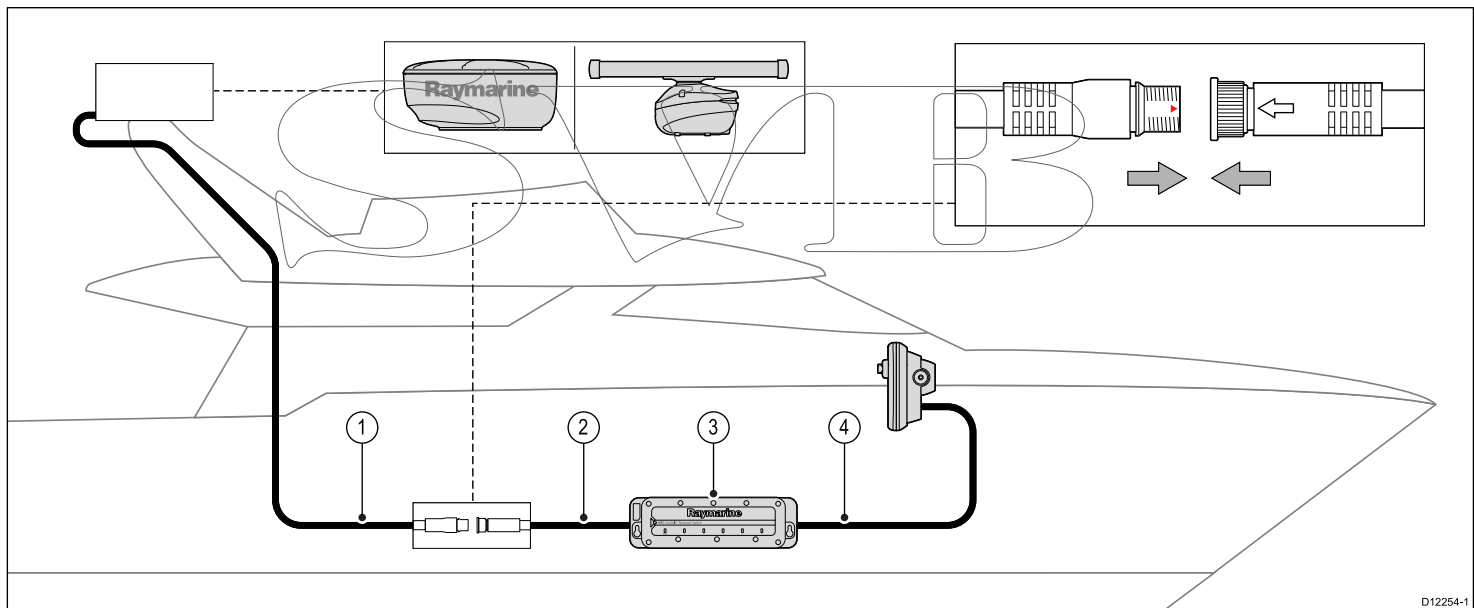

1. Radar extension cable.
2. Radar power and data digital cable.
3. Raymarine network switch (or crossover coupler if connecting radar directly to display).
4. RayNet cable (or RayNet to SeaTalk^{hs} cable if connecting via crossover coupler).

Note: The extension cable connects to the radar scanner.

Note: The power connection is NOT shown in the diagram. If using an Open Array scanner a VCM (Voltage Converter Module) must be connected between the scanner and the power supply.

Digital radar cables

You will need a dedicated radar power and data digital cable and SeaTalk^{hs} network cables to connect your scanner to your system.

Connection	Required cable
Radar scanner to power supply and Raymarine network switch.	Power and data digital cable. For longer cable runs, extensions are available in a variety of lengths.
Raymarine network switch to multifunction display.	SeaTalk ^{hs} network cables, available in a variety of cable lengths.

Radar power and data digital cables

These cables contain the wires for a scanner's power and data connections.

Cable	Part number
5 m (16.4 ft) Power and data digital cable	A55076D
10 m (32.8 ft) Power and data digital cable	A55077D
15 m (49.2 ft) Power and data digital cable	A55078D
25 m (82.0 ft) Power and data digital cable	A55079D

Note: The maximum length for the radar power and data digital cable (including any extensions) is 25 m (82 ft).

Radar power and data digital extension cables

These cables extend the power and data digital cables for a scanner's power and data connections.

Cable	Part number
2.5 m (8.2 ft) Power and data digital cable	A92141D
5 m (16.4 ft) Power and data digital cable	A55080D
10 m (32.8 ft) Power and data digital cable	A55081D

Note: The maximum length for the radar power and data digital cable (including any extensions) is 25 m (82 ft).

Sonar connection

A sonar connection is required for fishfinder applications.

There are 2 types of connection required for fishfinder applications:

- **Sonar module connection** — converts the sonar signals provided by the sonar transducer into data suitable for a marine electronics system. The sonar variant multifunction displays feature a built-in sonar, enabling you to connect the display directly to a compatible sonar transducer. Non-sonar variants require a connection to an external Raymarine sonar module. Internal and external sonars require a connection to a compatible sonar transducer.
- **Sonar transducer connection** — provides sonar signals to the sonar module.

Sonar module connection

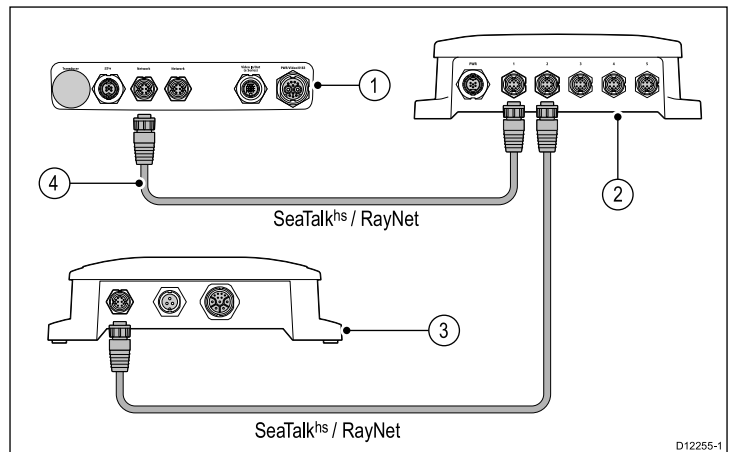

1. Rear connector panel of multifunction display (Non-sonar variant).
2. Raymarine network switch.
3. Raymarine sonar module.
4. RayNet cable.

The multifunction display can be used with the following Raymarine sonar modules:

- CP450C
- DSM300
- DSM30

Note: You can also connect a sonar variant multifunction display to a Raymarine sonar module. This is useful in circumstances where you need a higher powered sonar module for example. You can only use one sonar transducer at any one time.

Sonar connected directly to the display

On smaller systems (with only one display and no other SeaTalk^{hs} / RayNet devices) the sonar module may be connected directly to the display without using a Raymarine network switch.

Note: You must ensure that the cable ends connected into the display and sonar module have a locking / weather-tight mechanism.

Compatible sonar transducers

The multifunction display is compatible with the following sonar transducers:

- Raymarine P48.
- Raymarine P58.
- Minn Kota transducers (Sonar variant Raymarine displays only), via optional A62363 adaptor cable.
- Any 600 watt sonar-compatible transducer, via optional E66066 adaptor cable.

Sonar transducer connection — Sonar variant multifunction displays

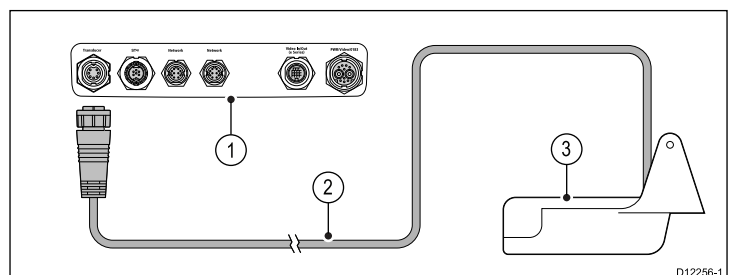

1. Rear connector panel of multifunction display (Sonar variant).
2. Sonar transducer cable.
3. Sonar transducer.

600 watt sonar-compatible sonar transducer connection via optional adaptor — Sonar variant multifunction displays

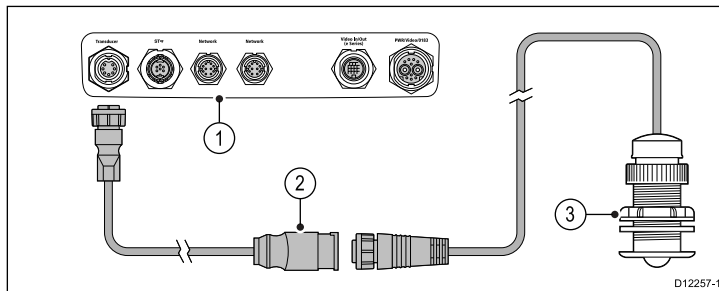

1. Rear connector panel of multifunction display (Sonar variant).
2. E66066 adaptor cable.
3. Sonar transducer.

Transducer adaptor cable

Cable	Part number
0.5 m (1.64 ft) transducer adaptor cable	E66066

Sonar transducer connection — Non-Sonar variant multifunction displays

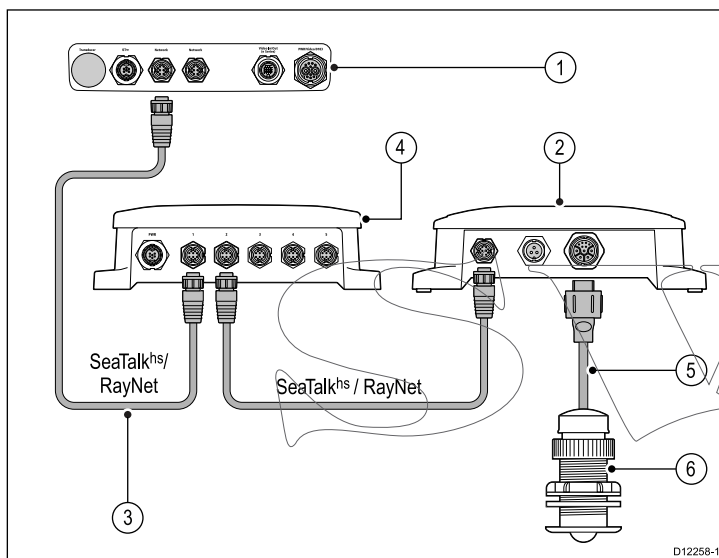

1. Rear connector panel of multifunction display (Non-sonar variant).
2. Raymarine network switch (only required if connecting more than one device using SeaTalk^{hs} / RayNet).
3. RayNet cable.
4. Raymarine sonar module.
5. Sonar transducer cable.
6. Sonar transducer.

Minn Kota sonar transducer connection via optional adaptor cable (Sonar variant multifunction displays only)

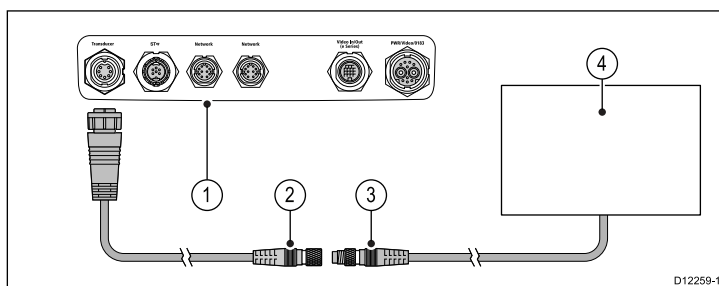

1. Rear connector panel of multifunction display (Sonar variant).
2. Minn Kota transducer adaptor cable.
3. Minn Kota transducer cable.
4. Minn Kota transducer.

Sonar variant multifunction displays

The table below details which multifunction display variants feature a built-in sonar module and can be connected directly to compatible sonar transducers.

Sonar variants	Non-sonar variants
a67	a65
e7D	e7
c97	c95
c127	c125
e97	e95
e127	e125
	e165

Minn Kota transducer adaptor cable

Connects a Minn Kota sonar transducer to a compatible Raymarine multifunction display.

Cable	Part number
1 m (3.28 ft) Minn Kota transducer adaptor cable	A62363

Thermal camera connection

You can connect a thermal camera to your New c Series or New e Series multifunction displays.

Note: New a Series does not support thermal cameras.

The camera is connected via a Raymarine network switch. If you want to use the optional Joystick Control Unit (JCU) with the camera this must also be connected to the network switch. A composite video connection is required between the camera and the multifunction display.

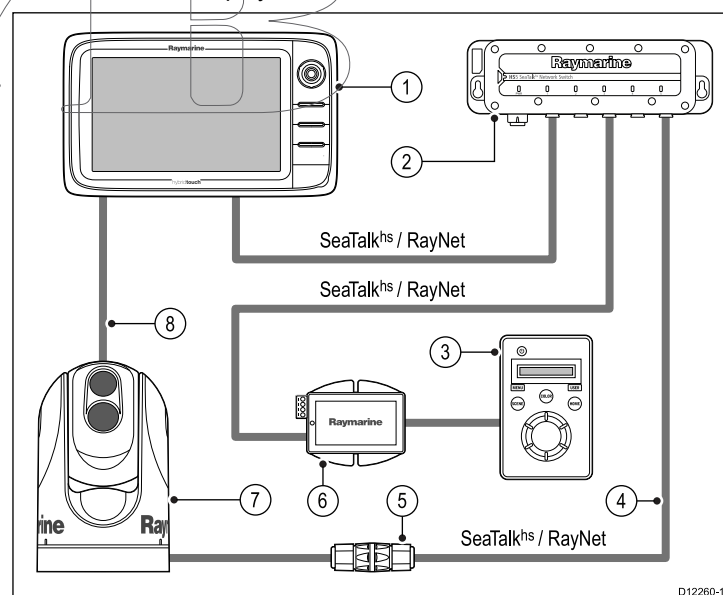

1. Multifunction display
2. Raymarine network switch
3. Joystick Control Unit (JCU), optional
4. SeaTalk^{hs} to RayNet cable
5. Ethernet cable coupler.
6. PoE (Power over Ethernet) injector (only required if using the optional JCU).
7. Thermal camera
8. Video connection

Important notes

- You can control the thermal camera using your multifunctional display. The Joystick Control Unit (JCU) is optional, but can be

used in conjunction with the multifunctional display to control the thermal camera if required.

- “Dual payload” thermal cameras include 2 independent lenses; 1 for thermal (infrared) and 1 for visible light. If you only have 1 display you should only connect the video cable labelled “VIS / IR” (visible light / infrared) to the display. If you have 2 or more displays you should connect 1 cable to each display.
- You can only view the thermal camera image on the multifunction display to which the camera is physically connected. If you want to view the thermal camera image on more than 1 display you must obtain a suitable third-party video distribution unit.
- For further information regarding the camera's installation (including connections and mounting), refer to the installation instructions that accompany the camera.

Thermal camera cables

Cabling requirements for thermal cameras.

Camera to network switch

A network patch cable is required to connect the camera to the network switch. The connection is made between the camera cable tail and the network switch via the coupler (supplied with the camera). Network patch cables are available in a variety of lengths.

Joystick Control Unit (JCU)

An Ethernet (with power) cable is used to connect the JCU. The JCU is supplied with a 7.62 m (25 ft) Ethernet cable for this connection. If you require a different length contact your dealer for suitable cables.

Power over Ethernet (PoE) injector to network switch

A network patch cable is required for connecting the PoE injector to the network switch. Network patch cables are available in a variety of lengths.

Video cables

Video cables are not supplied with the product. Please contact your dealer for suitable cables and adaptors.

Raymarine recommends the use of a BNC terminated RG59 75ohm (or better) coaxial cable.

IP Camera connections

You can connect IP cameras to your multifunction display.

Note: IP cameras must be configured to automatically assign an IP address prior to connecting to your multifunction display or network. Please refer to the instructions supplied with your IP camera for configuration details.

Note: Your multifunction display must be powered up before power is applied to any networked IP cameras, this is to enable your multifunction display to assign the IP camera(s) a valid IP address.

IP camera(s) can be connected directly to the SeaTalk^{hs} RayNet connector on your multifunction display.

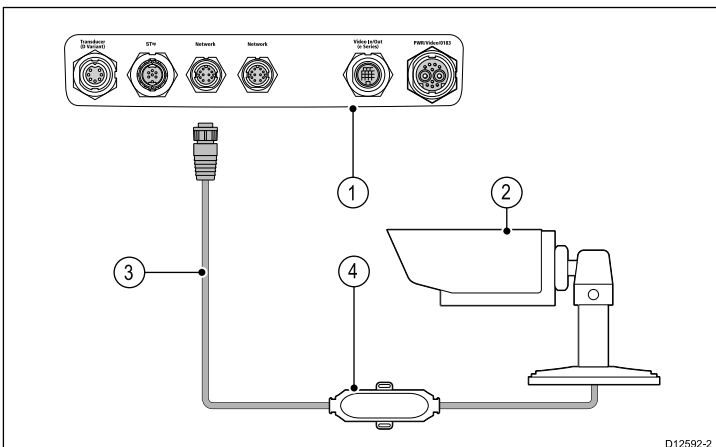

D12592-2

Item	Description
1	Multifunction display rear connector panel
2	IP camera

Item	Description
3	RayNet to RJ45 cable
4	SeaTalk ^{hs} cross over coupler

You can also connect multiple IP cameras via the SeaTalk^{hs} network

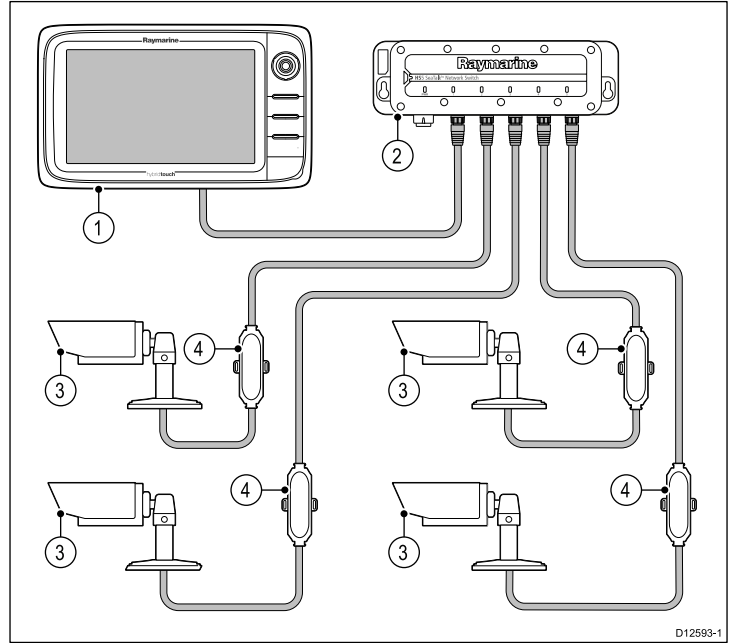

D12593-1

Item	Description
1	Multifunction display
2	Raymarine network switch
3	IP cameras
4	SeaTalk ^{hs} cross over couplers

Note: Multifunction displays do not provide power over ethernet (PoE) connected cameras must have their own power supply.

Note: If your IP camera(s) are not detected by your multifunction display, try power cycling the IP camera(s) whilst leaving your multifunction display powered up.

4.6 GPS connection

Depending on display variant, your multifunction display may include an internal GPS receiver. If required the multifunction display can also be connected to an external GPS receiver, using SeaTalk^{ng} or NMEA 0183.

GPS connection — SeaTalk^{ng}

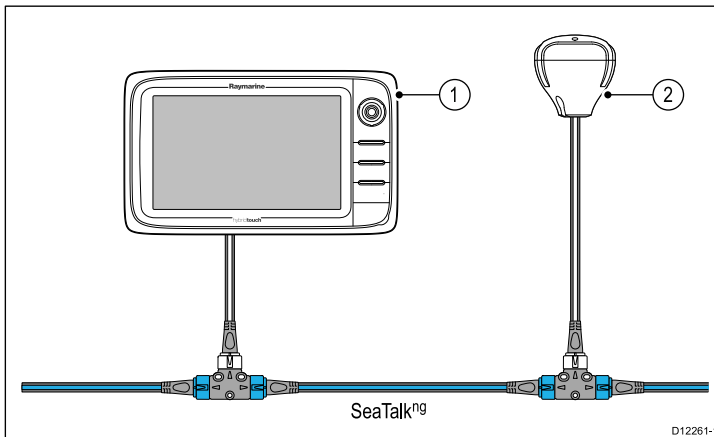

1. Multifunction display.
2. SeaTalk^{ng} GPS receiver.

GPS connection — NMEA 0183

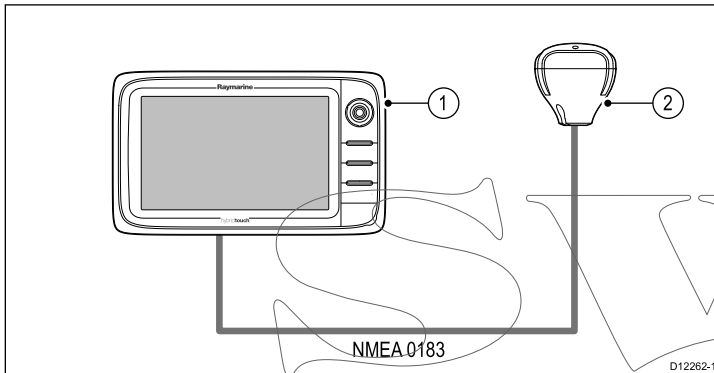

1. Multifunction display.
2. NMEA 0183 GPS receiver.

4.7 AIS connection

A compatible AIS can be connected using SeaTalk^{ng} or NMEA 0183.

Connection using SeaTalk^{ng}

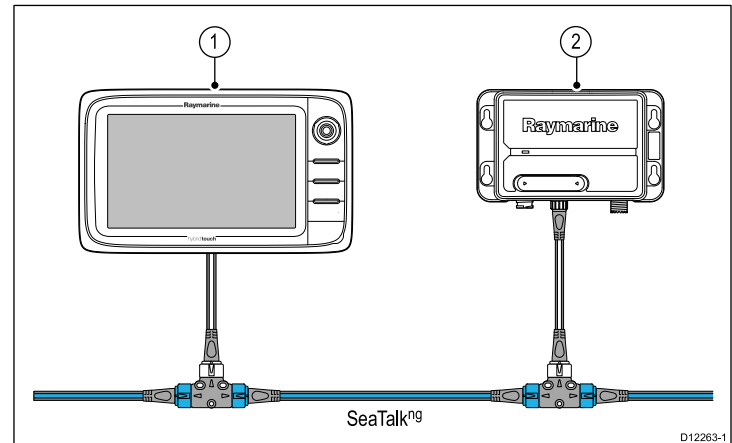

1. Multifunction display.
2. SeaTalk^{ng} AIS receiver / transceiver.

Connection using NMEA 0183

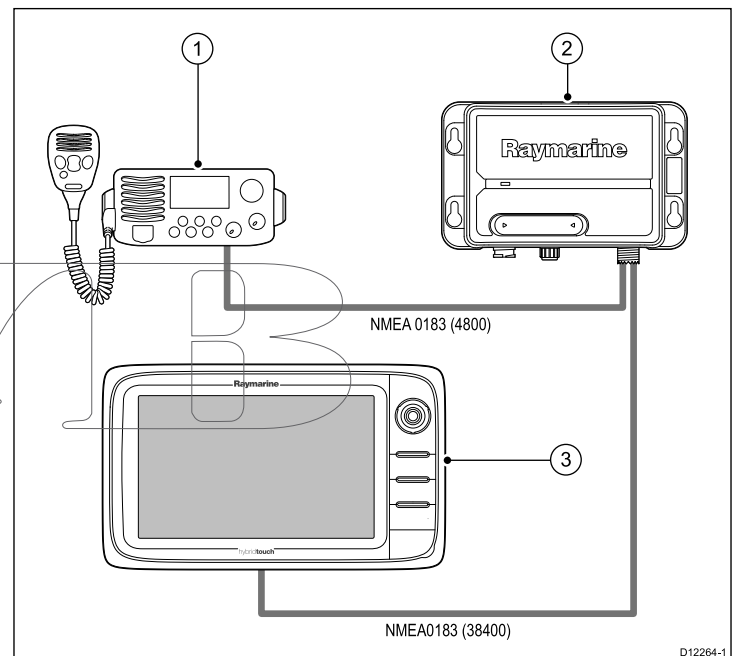

1. VHF radio.
2. AIS unit.
3. Multifunction display.

4.8 Fastheading connection

If you wish to use MARPA (radar target acquisition) functions on your multifunction display you need either:

- An autopilot connected to the multifunction display via SeaTalk^{ng} or NMEA 0183. The compass is connected to the course computer and calibrated via the pilot control head; or:
- A Raymarine or third-party fastheading sensor connected to the multifunction display via NMEA 0183.

Note: Please contact your dealer or Raymarine technical support for more information.

4.9 SeaTalk^{ng} connections

The display can connect to a SeaTalk^{ng} system.

The display can use SeaTalk^{ng} to communicate with:

- SeaTalk^{ng} instruments (for example, i70).
- SeaTalk^{ng} autopilots (for example, p70 with SmartPilot SPX course computer).
- SeaTalk equipment via the optional SeaTalk to SeaTalk^{ng} converter.
- NMEA 2000 equipment via optional DeviceNet adaptor cables.

Typical SeaTalk^{ng} system

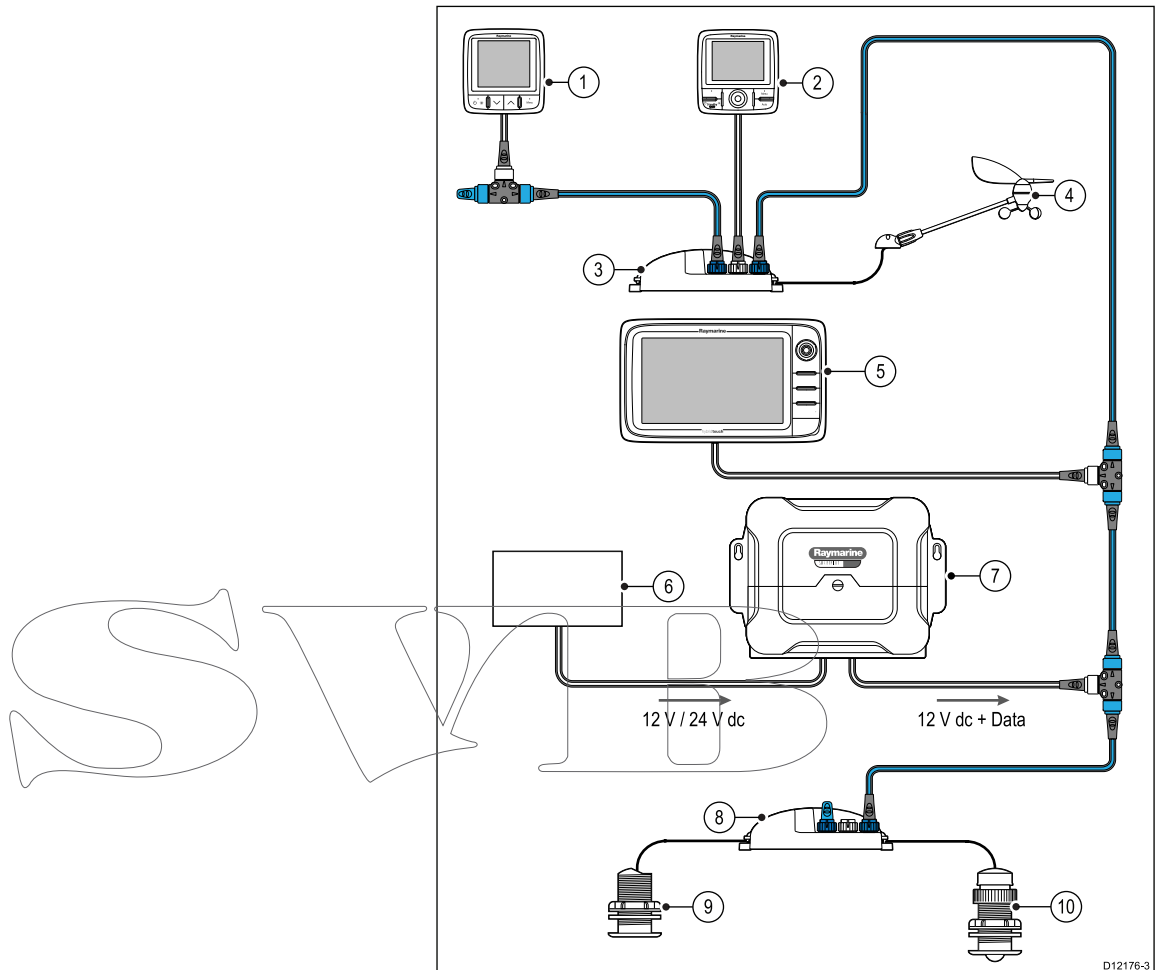

1. SeaTalk^{ng} instrument — for example, i70.
2. SeaTalk^{ng} pilot control head — for example, p70.
3. iTC-5 converter.
4. Wind transducer.
5. SeaTalk^{ng} multifunction display.
6. Power supply.
7. SeaTalk^{ng} course computer — for example, SPX-30.
8. iTC-5 converter.
9. Depth transducer.
10. Speed transducer.

SeaTalk^{ng} power requirements

The SeaTalk^{ng} bus requires a 12 V power supply.

Power may be provided from:

- Raymarine equipment with a regulated 12 V power supply (for example, a SmartPilot SPX course computer); or:
- Other suitable 12 V power supply.

Note: SeaTalk^{ng} does NOT supply power to multifunction displays and other equipment with a dedicated power supply input.

SeaTalk^{ng} cabling components

SeaTalk^{ng} cabling components and their purposes.

Connection / Cable	Notes
Backbone cable (various lengths)	The main cable carrying data. Spurs from the backbone are used to connect SeaTalk ^{ng} devices.
T-piece connector	Used to make junctions in the backbone to which devices can then be connected.
Terminator	Required at either end of the backbone.
Inline terminator	Used to connect a spur cable directly to the end of a backbone; useful for longer cable runs.
Spur cable	Used to connect devices to the backbone. Devices may be daisy chained or connected directly to the T-pieces.
SeaTalk ^{ng} 5-way connector	Used to branch, split, or make additional connections in SeaTalk or SeaTalk ^{ng} networks.
Blanking plug	Inserted into unused spur connector positions in a 5-way connector or T-piece.

SeaTalk^{ng} cables and accessories

SeaTalk^{ng} cables and accessories for use with compatible products.

Description	Part No	Notes
Backbone Kit	A25062	Includes: <ul style="list-style-type: none"> • 2 x 5 m (16.4 ft) Backbone cable • 1 x 20 m (65.6 ft) Backbone cable • 4 x T-piece • 2 x Backbone terminator • 1 x Power cable
SeaTalk ^{ng} 0.4 m (1.3 ft) spur	A06038	
SeaTalk ^{ng} 1 m (3.3 ft) spur	A06039	
SeaTalk ^{ng} 3 m (9.8 ft) spur	A06040	
SeaTalk ^{ng} 5 m (16.4 ft) spur	A06041	
SeaTalk ^{ng} 0.4 m (1.3 ft) backbone	A06033	
SeaTalk ^{ng} 1 m (3.3 ft) backbone	A06034	
SeaTalk ^{ng} 3 m (9.8 ft) backbone	A06035	
SeaTalk ^{ng} 5 m (16.4 ft) backbone	A06036	
SeaTalk ^{ng} 9 m (29.5 ft) backbone	A06068	
SeaTalk ^{ng} 20 m (65.6 ft) backbone	A06037	
SeaTalk ^{ng} to bare ends 1 m (3.3 ft) spur	A06043	

Description	Part No	Notes
SeaTalk ^{ng} to bare ends 3 m (9.8 ft) spur	A06044	
SeaTalk ^{ng} Power cable	A06049	
SeaTalk ^{ng} Terminator	A06031	
SeaTalk ^{ng} T-piece	A06028	Provides 1 x spur connection
SeaTalk ^{ng} 5-way connector	A06064	Provides 3 x spur connections
SeaTalk to SeaTalk ^{ng} converter	E22158	Allows the connection of SeaTalk devices to a SeaTalk ^{ng} system.
SeaTalk ^{ng} Inline terminator	A80001	Provides direct connection of a spur cable to the end of a backbone cable. No T-piece required.
SeaTalk ^{ng} Blanking plug	A06032	
SeaTalk (3 pin) to SeaTalk ^{ng} adaptor cable 0.4 m (1.3 ft)	A06047	
SeaTalk2 (5 pin) to SeaTalk ^{ng} adaptor cable 0.4 m (1.3 ft)	A06048	
DeviceNet adaptor cable (Female)	A06045	Allows the connection of NMEA 2000 devices to a SeaTalk ^{ng} system.
DeviceNet adaptor cable (Male)	A06046	Allows the connection of NMEA 2000 devices to a SeaTalk ^{ng} system.
DeviceNet adaptor cable (Female) to bare ends.	E05026	Allows the connection of NMEA 2000 devices to a SeaTalk ^{ng} system.
DeviceNet adaptor cable (Male) to bare ends.	E52027	Allows the connection of NMEA 2000 devices to a SeaTalk ^{ng} system.

4.10 SeaTalk connection

You can connect SeaTalk devices to your multifunction display using the optional SeaTalk to SeaTalk^{ng} converter.

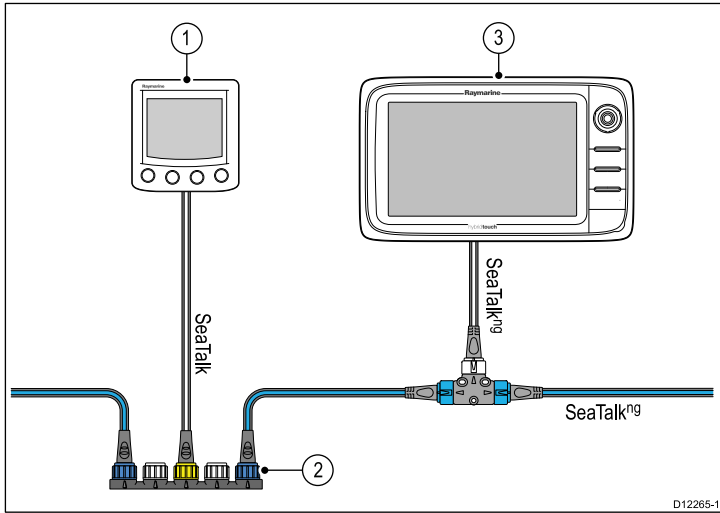

1. SeaTalk device.
2. SeaTalk to SeaTalk^{ng} converter.
3. Multifunction display.

SeaTalk accessories

SeaTalk cables and accessories for use with compatible products.

Description	Part No	Notes
3-way SeaTalk junction box	D244	
1 m (3.28 ft) SeaTalk extension cable	D284	
3 m (9.8 ft) SeaTalk extension cable	D285	
5 m (16.4 ft) SeaTalk extension cable	D286	
9 m (29.5 ft) SeaTalk extension cable	D287	
12 m (39.4 ft) SeaTalk extension cable	E25051	
20 m (65.6 ft) SeaTalk extension cable	D288	

4.11 NMEA 0183 connection

NMEA 0183 devices can be connected to New c Series and New e Series multifunction displays using the power and data cable.

Note: New a Series does not support connection of NMEA 0183 devices.

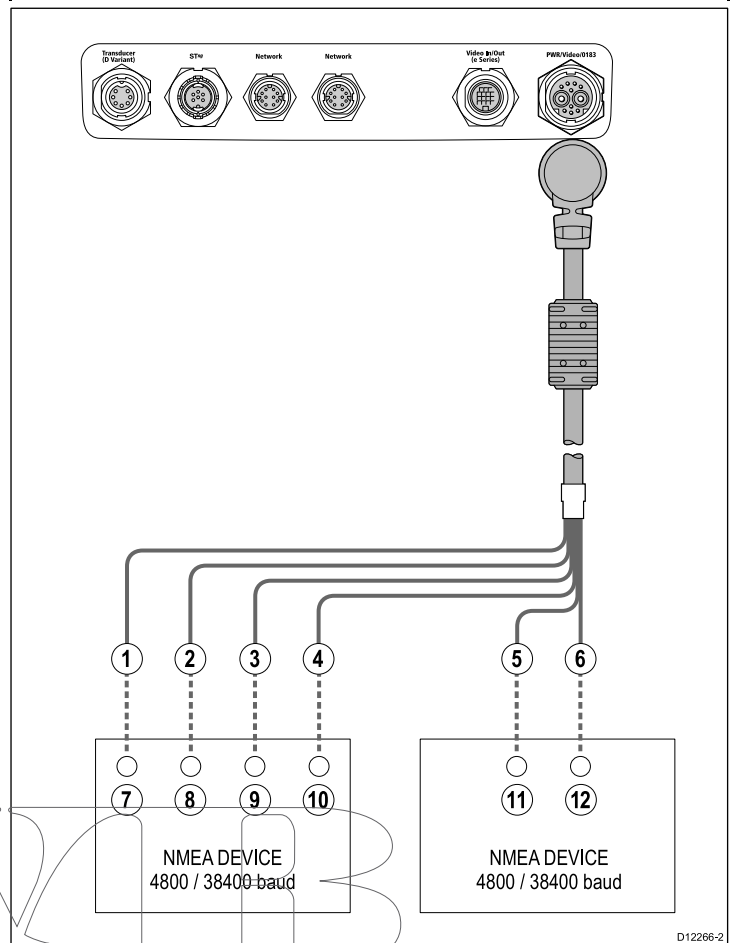

NMEA 0183 devices are connected using the supplied power and data cable.

The display has 2 NMEA 0183 ports:

- **Port 1:** Input and output, 4800 or 38400 baud rate.
- **Port 2:** Input only, 4800 or 38400 baud rate.

Note: The baud rate you want to use for each port input must be specified in the System Settings menu (**Homescreen**: > **Set-up** > **System Settings** > **NMEA Set-up** > **NMEA Input Port**).

Note: For Port 1, both the input and output communicate at the same baud rate. For example, if you have one NMEA 0183 device connected to the display's Port 1 INPUT, and another NMEA 0183 device connected to the display's Port 1 OUTPUT, both NMEA devices must be using the same baud rate.

You can connect up to 4 NMEA 0183 devices to the display's NMEA 0183 OUTPUT (Port 1). You can connect a total of 2 NMEA 0183 devices to the display's NMEA 0183 INPUT ports.

Item	Device	Cable color	Port	Input / output	Positive (+) / negative (-)
1	Multifunction display	White	1	Input	Positive
2		Green	1	Input	Negative
3		Yellow	1	Output	Positive
4		Brown	1	Output	Negative
5		Orange / white	2	Input	Positive
6		Orange / green	2	Input	Negative

Item	Device	Cable color	Port	Input / output	Positive (+) / negative (-)
7	NMEA device	*	*	Output	Positive
8		*	*	Output	Negative
9		*	*	Input	Positive
10		*	*	Input	Negative
11	NMEA device	*	*	Output	Positive
12		*	*	Output	Negative

4.12 NMEA 2000 connection

The display can receive data from NMEA 2000 devices (e.g. data from compatible engines). The NMEA 2000 connection is made using SeaTalk^{ng} and appropriate adaptor cables.

You can EITHER:

- Use your SeaTalk^{ng} backbone and connect each NMEA 2000 device on a spur, OR
- connect the display on a spur into an existing NMEA 2000 backbone.

Important: You cannot have 2 backbones connected together.

Connecting NMEA 2000 equipment to the SeaTalk^{ng} backbone

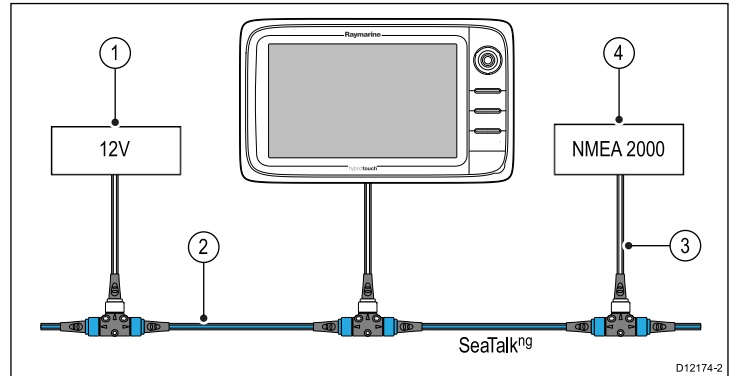

1. 12 V supply into backbone.
2. SeaTalk^{ng} backbone.
3. SeaTalk^{ng} to DeviceNet adaptor cable.
4. NMEA 2000 equipment.

NMEA 0183 cable

You can extend the NMEA 0183 wires within the supplied power and data cable.

Data cable extension

Total length (max)	Cable
Up to 5 m	High quality data cable: <ul style="list-style-type: none"> • 2 x twisted pair with overall shield. • 50 to 75 pF/m capacitance core to core.

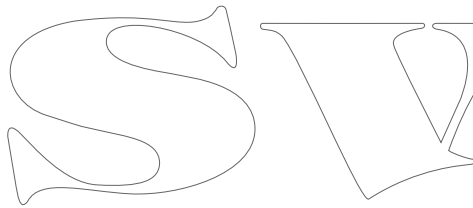

Connecting the display to an existing NMEA 2000 (DeviceNet) backbone

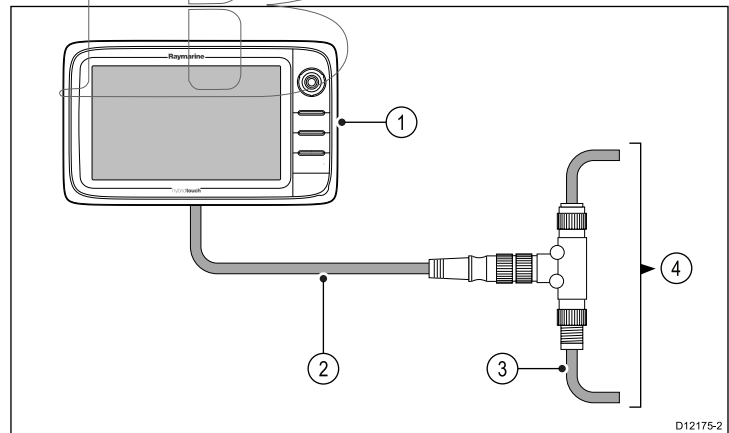

1. Multifunction display.
2. SeaTalk^{ng} to DeviceNet adaptor cable.
3. DeviceNet backbone.
4. NMEA 2000 equipment.

4.13 Camera / Video connection

A camera or a video device can be connected directly to New c Series and New e Series multifunction displays using the video connector on the power and data cable.

Note: Video devices cannot be directly connected to New a Series multifunction displays. For camera connections to a New a Series display please refer to the *IP camera connection* section.

Examples of video sources that you can connect to the display include:

- Video camera.
- Thermal camera.
- DVD player.
- Portable digital video player.

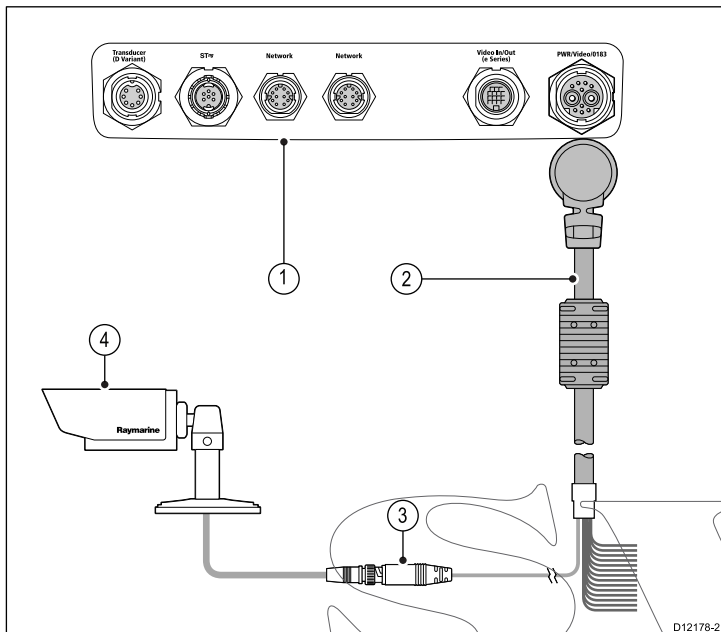

1. Rear connector panel of multifunction display.
2. Power and data cable.
3. BNC video connector (input 1).
4. Video source — for example, video camera.

Note: To listen to a movie's audio track, any connected DVD or digital video player will require speakers to be connected to the player's audio output.

4.14 Camera / video in-out connection

A camera / video device or external display can be connected to New e Series multifunction displays (excluding the e7 / e7D) using the dedicated video in/out connector.

Note: New a Series and New c Series multifunction displays do not have a dedicated video in/out connector.

Video In

Examples of video input sources that you can connect to the display include:

- Video camera.
- Thermal camera.
- DVD player.
- Portable digital video player.

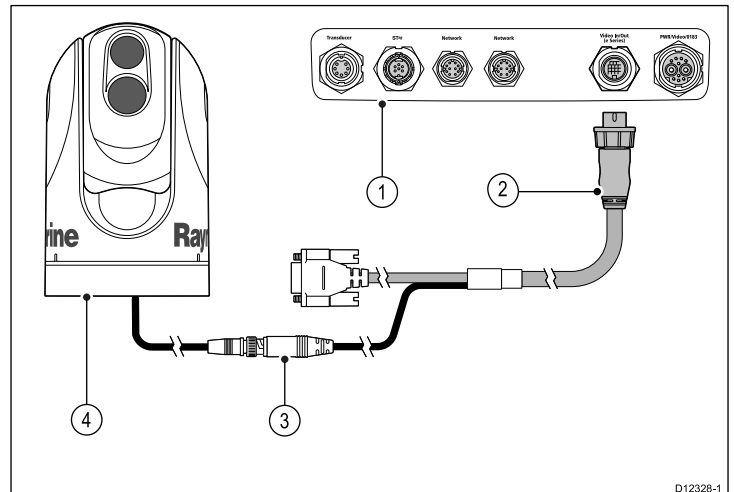

1. Rear connector panel of multifunction display.
2. Video accessory cable.
3. BNC video connector (input 2).
4. Thermal camera.

Note: To listen to a movie's audio track, any connected DVD or digital video player will require speakers to be connected to the player's audio output.

Video out

Examples of video output devices that you can connect to the display include:

- HDTV with VGA input.
- VGA monitor.

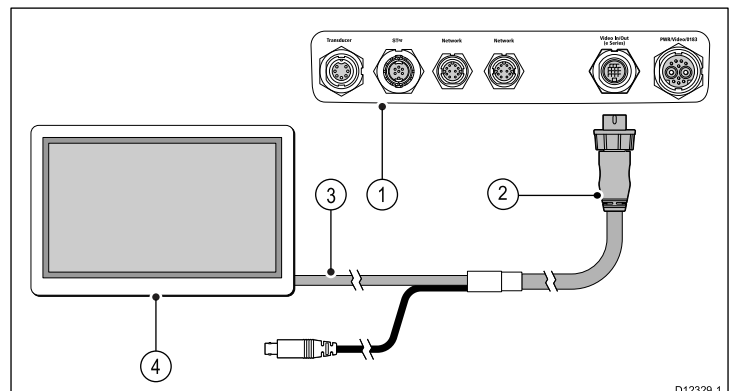

1. Rear connector panel of multifunction display.
2. Video accessory cable.
3. VGA cable to external display.
4. External display.

Video specification

Signal type	Composite
Format	PAL or NTSC

Connector type	BNC (female)
Output resolution	720p

Video cables

The following video cable is required for the video in / out connector on the e95 / e97 / e125 / e127 variant multifunction displays.

Part number	Description	Notes
R70003	e-series accessory video cable	

4.15 Bluetooth connections

Remote control connection

You can control the multifunction display wirelessly using a Raymarine remote control unit.

The remote control uses a Bluetooth wireless connection.

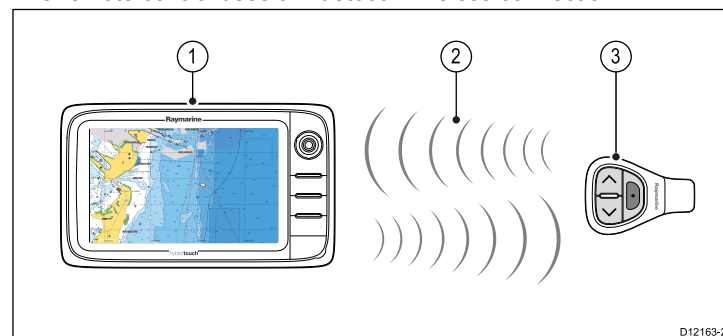

1. Multifunction display.
2. Bluetooth connection.
3. Raymarine Bluetooth remote control (for example, RCU-3).

To use the remote control you must first:

- Enable Bluetooth in the System Settings on the multifunction display.
- Pair the remote control unit with the multifunction display.

Pairing the remote and configuring the UP and DOWN buttons

The remote control unit must be "paired" with the multifunction display that you want to control. On your multifunction display, with the homescreen displayed:

1. Select **Set-up**.
2. Select **System Settings**.
3. Select **Wireless Connections**.
4. Select **Bluetooth > On**.
5. Select **New Bluetooth Connection**.

A pop-up message will be displayed to confirm that the device you are connecting to is discoverable.

6. Select **Ok** to confirm.
- A list of discovered devices is displayed.
7. On your **remote control unit**, hold down the UP and DOWN buttons together for 10 seconds.
8. Select the remote control unit in the list of devices.
9. When prompted, press the arrow button on your remote that you wish to be configured as the UP button. The other arrow button will automatically be configured as the DOWN button.

If the pairing was successful a "Pairing Success" message will be displayed. If a "Pairing Failure" or "Pairing Timeout" message is displayed, repeat steps 1 to 8.

Media player connection

You can use your multifunction display to wirelessly control a Bluetooth-compatible media player (such as a smartphone).

The media player must be compatible with the Bluetooth AVRCP protocol (version 2.1 or higher).

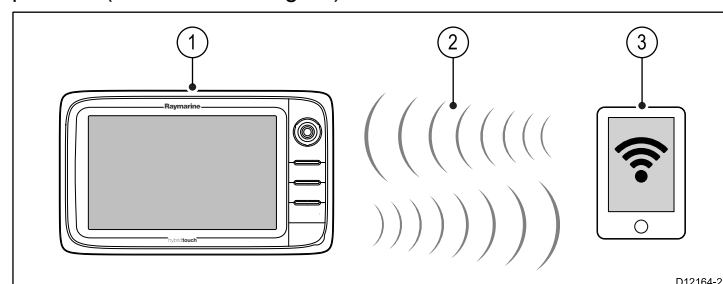

1. Multifunction display.
2. Bluetooth connection.
3. Bluetooth-compatible media player.

To use this feature you must first:

- Enable Bluetooth in the System Settings on the multifunction display.
- Enable Bluetooth on the media player device.
- Pair the media player device with the multifunction display.
- Enable Audio Control in the System Settings on the multifunction display.
- Connect an RCU-3 remote and assign the shortcut key to Start/Stop audio playback (Only required on a New c Series display).

Note: If your media player does not include built-in speakers it may be necessary to connect the media player's audio output to an external audio system or a pair of headphones. For more information refer to the instructions that accompany the media player device.

4.16 WiFi connections

Raymarine mobile app connection

You can use compatible tablet and smartphone devices as a wireless repeat display or remote control for your multifunction display.

Raymarine apps allow you to stream and / or control, remotely what you see on your multifunction display to a compatible device, using a Wi-Fi connection.

To use this feature you must first:

- Ensure your device is compatible with the app you wish to use.
- Download and install the relevant Raymarine app, available from the relevant market store.
- Enable Wi-Fi in the System Settings on the multifunction display.
- Enable Wi-Fi on your compatible device.
- Select the Raymarine Wi-Fi connection from the list of available Wi-Fi networks on your compatible device.
- Enable the relevant Mobile app in the System Settings menu on the multifunction display.

Note: The multifunction display acts as a Wi-Fi access point. If your device already connects to an access point for e-mail and internet you must revert your access point back to regain access to e-mails and internet.

Navionics chartplotter sync connection

You can wirelessly synchronize waypoints and routes between the multifunction display and a tablet or smartphone device.

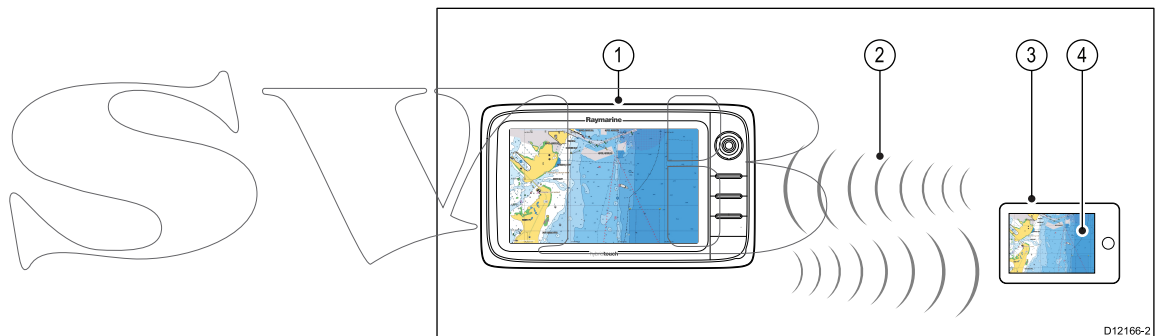

1. Multifunction display.
2. Wi-Fi connection.
3. Tablet / smartphone.
4. Navionics Marine app.

To use this feature you must first:

- Download and install the Navionics Marine app, available from the relevant app store.
- Enable Wi-Fi in the System Settings on the multifunction display.
- Enable Wi-Fi on your tablet / smartphone.
- Select the Raymarine Wi-Fi connection from the list of available Wi-Fi networks on your tablet / smartphone.

Chapter 5: Location and mounting

Chapter contents

- [5.1 Selecting a location on page 58](#)
- [5.2 Mounting - New a Series on page 59](#)
- [5.3 Mounting - New c Series and New e series on page 61](#)

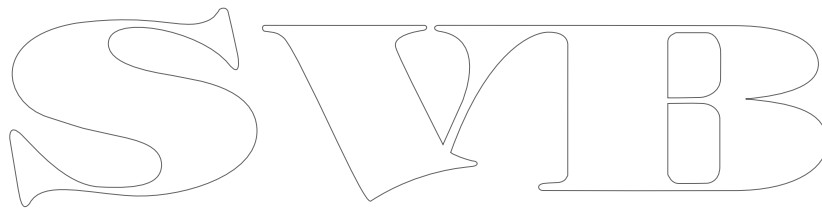

5.1 Selecting a location



Warning: Potential ignition source

This product is NOT approved for use in hazardous/flammable atmospheres. Do NOT install in a hazardous/flammable atmosphere (such as in an engine room or near fuel tanks).

General location requirements

When selecting a location for your display it is important to consider a number of factors.

Key factors which can affect product performance are:

• Ventilation

To ensure adequate airflow:

- Ensure that equipment is mounted in a compartment of suitable size.
- Ensure that ventilation holes are not obstructed. Allow adequate separation of equipment.

Any specific requirements for each system component are provided later in this chapter.

• Mounting surface

Ensure equipment is adequately supported on a secure surface. Do not mount units or cut holes in places which may damage the structure of the vessel.

• Cable entry

Ensure the unit is mounted in a location which allows proper routing and connection of cables:

- Minimum bend radius of 100 mm (3.94 in) unless otherwise stated.
- Use cable supports to prevent stress on connectors.

• Water ingress

The display is suitable for mounting both above and below decks. It is waterproof to IPX6 standard. Although the unit is waterproof, it is good practice to locate it in a protected area away from prolonged and direct exposure to rain and salt spray.

• Electrical interference

Select a location that is far enough away from devices that may cause interference, such as motors, generators and radio transmitters / receivers.

• Power supply

Select a location that is as close as possible to the vessel's DC power source. This will help to keep cable runs to a minimum.

Compass safe distance

To prevent potential interference with the vessel's magnetic compasses, ensure an adequate distance is maintained from the display.

When choosing a suitable location for the multifunction display you should aim to maintain the maximum possible distance between the display and any compasses. Typically this distance should be at least 1 m (3 ft) in all directions. However for some smaller vessels it may not be possible to locate the display this far away from a compass. In this situation, the following figures provide the minimum safe distance that should be maintained between the display and any compasses.

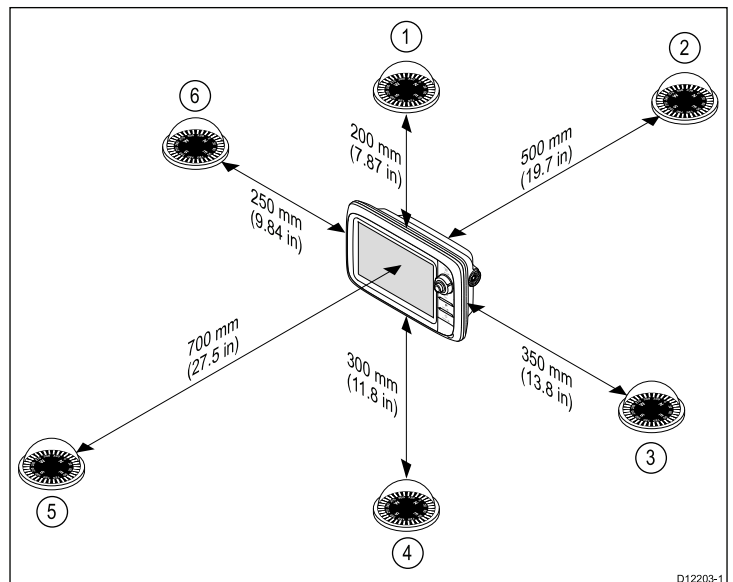

D12203-1

Item	Compass position in relation to display	Minimum safe distance from display
1	Top	200 mm (7.87 in.)
2	Rear	500 mm (19.7 in.)
3	Right-hand side	350 mm (13.8 in.)
4	Underside	300 mm (11.8 in.)
5	Front	700 mm (27.5 in.)
6	Left-hand side	250 mm (9.84 in.)

GPS location requirements

In addition to general guidelines concerning the location of marine electronics, there are a number of environmental factors to consider when installing equipment with an internal GPS antenna.

Mounting location

• Above Decks mounting:

Provides optimal GPS performance. (For equipment with appropriate waterproof rating.)

• Below Decks mounting:

GPS performance may be less effective and may require an external GPS antenna mounted above decks.

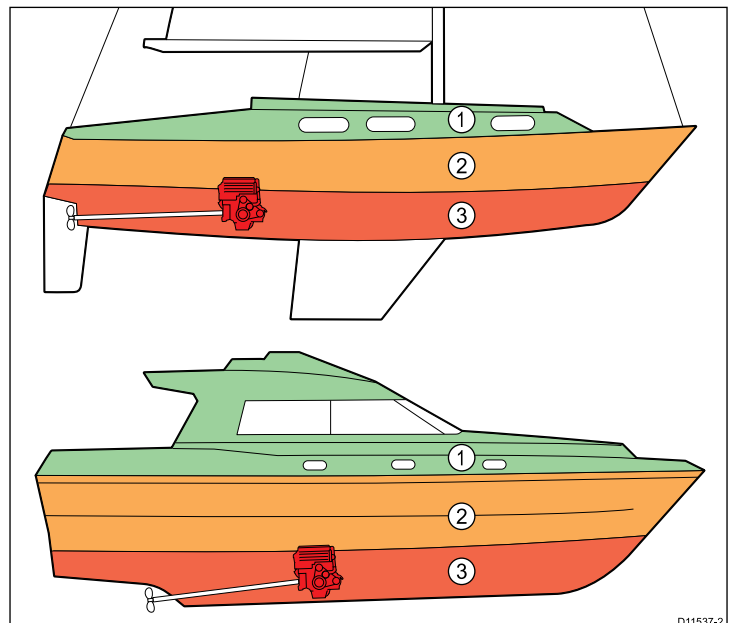

D11537-2

1.		This location provides optimal GPS performance (above decks).
2.		In this location, GPS performance may be less effective.
3.		This location is NOT recommended for GPS antenna.

Vessel construction

The construction of your vessel can have an impact on GPS performance. For example, the proximity of heavy structure such as a structural bulkhead, or the interior of larger vessels may result in a reduced GPS signal. Before locating equipment with an internal GPS antenna below decks, seek professional assistance and consider use of an external GPS antenna mounted above decks.

Prevailing conditions

The weather and location of the vessel can affect the GPS performance. Typically calm clear conditions provide for a more accurate GPS fix. Vessels at extreme northerly or southerly latitudes may also receive a weaker GPS signal. GPS antenna mounted below decks will be more susceptible to performance issues related to the prevailing conditions.

Viewing angle considerations

As display contrast, color and night mode performance are all affected by the viewing angle, Raymarine recommends you temporarily power up the display when planning the installation, to enable you to best judge which location gives the optimum viewing angle.

5.2 Mounting - New a Series

Viewing angle

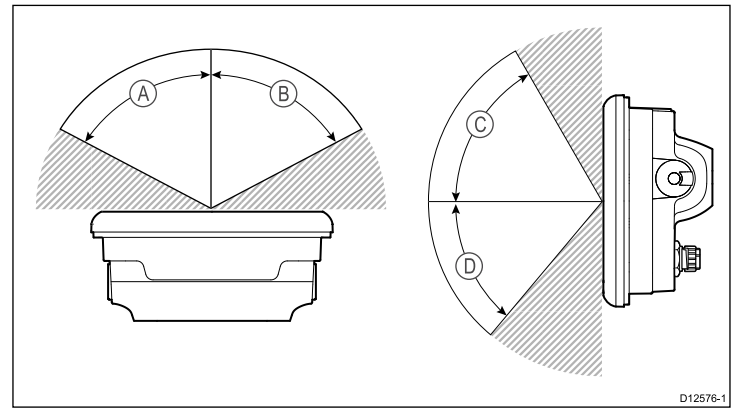

	a65 / a67
A	60°
B	60°
C	60°
D	50°

Note: The angles stated are for a contrast ratio of equal to or greater than 10.

Product dimensions

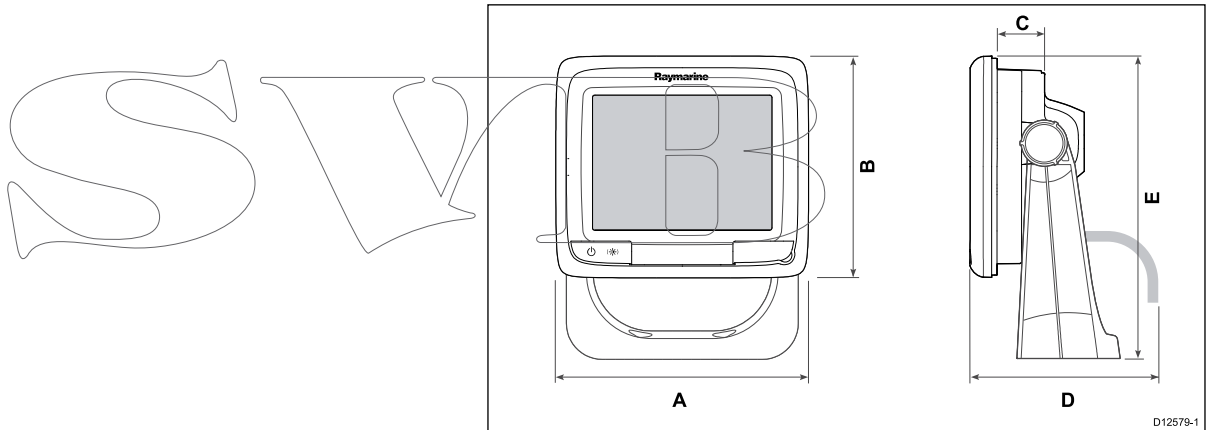

Item	a65 / a67
A	163.57 mm (6.44 in)
B	143.47 mm (5.65 in)
C	56.6 mm (2.23 in)
D	167.5 mm (6.6 in)
E	162.72 mm (6.41 in)

Flush mounting

You can mount the display in a flush or panel mounting arrangement. Before mounting the unit, ensure that you have:

- Selected a suitable location.
- Identified the cable connections and route that the cables will take.
- Detached the front bezel.

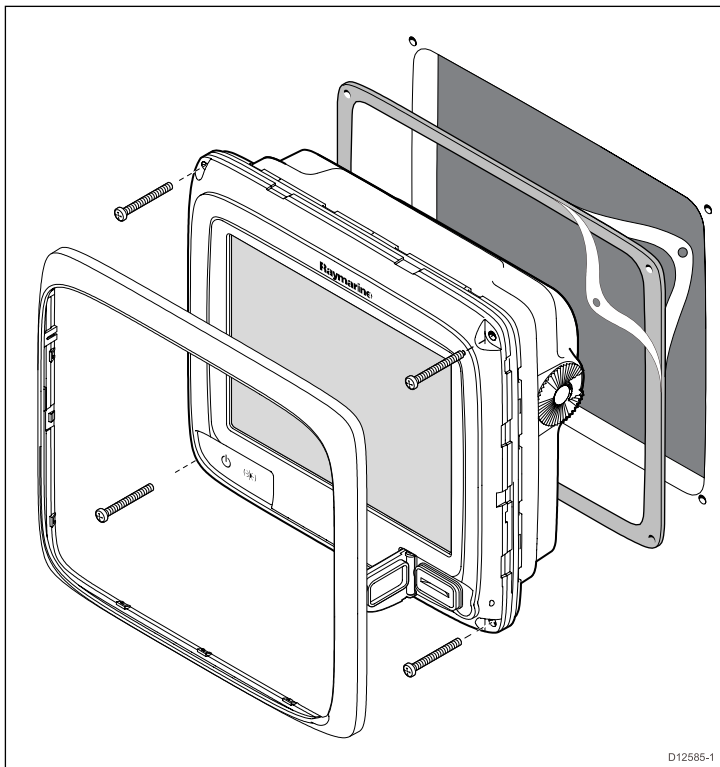

D12585-1

1. Check the selected location for the unit. A clear, flat area with suitable clearance behind the panel is required.
2. Drill or knock out the 4 mounting holes on the unit

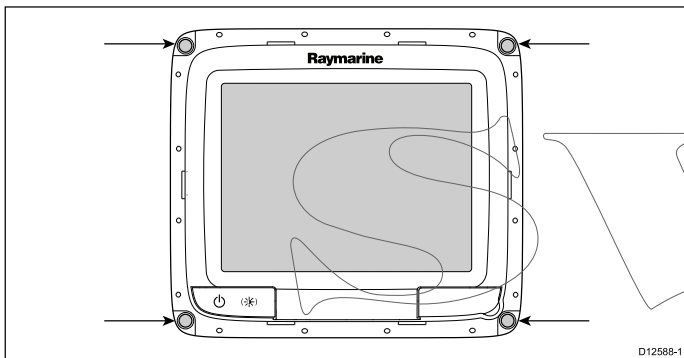

D12588-1

3. Fix the appropriate cutting template supplied with the product, to the selected location, using masking or self-adhesive tape.
4. Using a suitable hole saw (the size is indicated on the template), make a hole in each corner of the cut-out area.
5. Using a suitable saw, cut along the inside edge of the cut-out line.
6. Ensure that the unit fits into the removed area and then file around the rough edge until smooth.
7. Drill 4 holes as indicated on the template to accept the securing screws.
8. Place the gasket onto the display unit and press firmly onto the flange.
9. Connect the power, data and other cables to the unit.
10. Slide the unit into place and secure using the 4 mounting screws.

Note: The appropriate torque to use when drilling depends on the thickness of the mounting surface and the type of material.

Note: The supplied gasket provides a seal between the unit and a suitably flat and stiff mounting surface or binnacle. The gasket should be used in all installations. It may also be necessary to use a marine-grade sealant if the mounting surface or binnacle is not entirely flat and stiff or has a rough surface finish.

Bracket (trunnion) mounting

The display can be mounted on a trunnion bracket.

Before mounting the unit ensure that you have:

- Selected a suitable location.
- Identified the cable connections and route that the cables will take.

- Attached the front bezel.

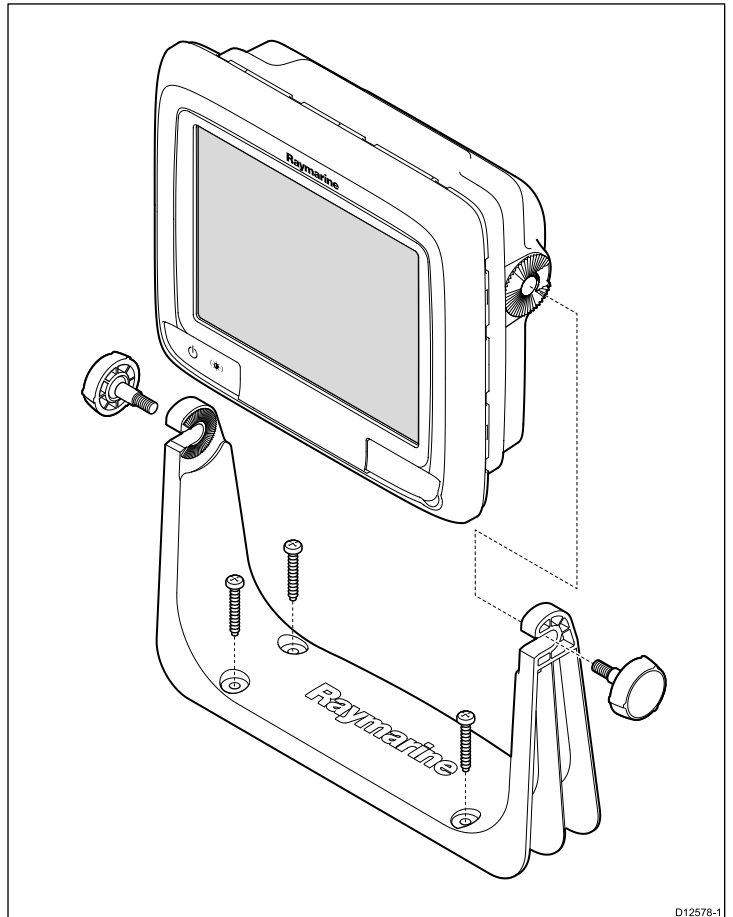

D12578-1

1. Mark the location of the mounting bracket screw holes on the chosen mounting surface.
2. Drill holes for the screws using a suitable drill, ensuring there is nothing behind the surface that may be damaged.
3. Use the screws supplied with the mounting bracket to attach securely.
4. Attach the display unit to the mounting bracket.

Note: The appropriate torque to use when drilling depends on the thickness of the mounting surface and the type of material.

Front bezel

Attaching the front bezel

The following procedure assumes that the unit has already been mounted in position.

1. Carefully lift one edge of the screen protection film, so that it is accessible for removing when unit installation is complete.
2. Ensure the memory card slot door is in the open position.
3. Orientate the bottom-right side of the bezel under the lip of the chart card door and place the bezel over the front of the display,

ensuring that the clips along the bottom edge of the bezel latch into position.

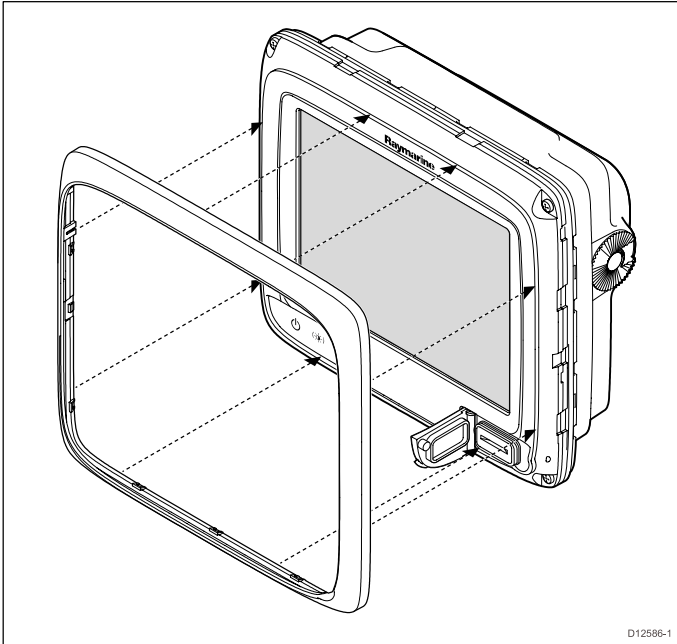

4. Ensure the bezel is correctly aligned with the display, as shown.
5. Apply firm but even pressure to the bezel along the:
 - i. Outer edges - work from the sides upwards and then along the top edge, to ensure that it clips securely into position.
 - ii. Inner edges - particularly along the chart card door edge, to ensure that the bezel sits flat.
6. Check that the **Power** button and chart card door are free to operate.

Removing the front bezel

Before proceeding ensure the memory card slot door is open.

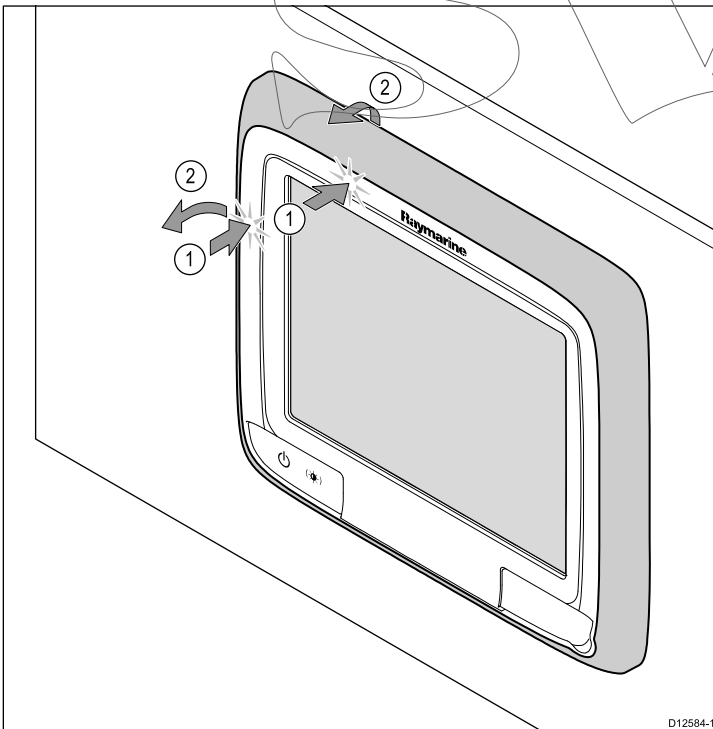

Important: Use care when removing the bezel. Do not use any tools to lever the bezel; doing so may cause damage.

1. Place both your thumbs on the upper left edge of the display, at the positions indicated in the diagram above.
2. Place your fingers underneath the bezel, at the positions indicated in the diagram above.
3. In a single firm motion, apply pressure to the outer edge of the display with your thumbs and pull the bezel towards you using your fingers.

The bezel should now come away from the display easily.

5.3 Mounting - New c Series and New e series

Viewing angle

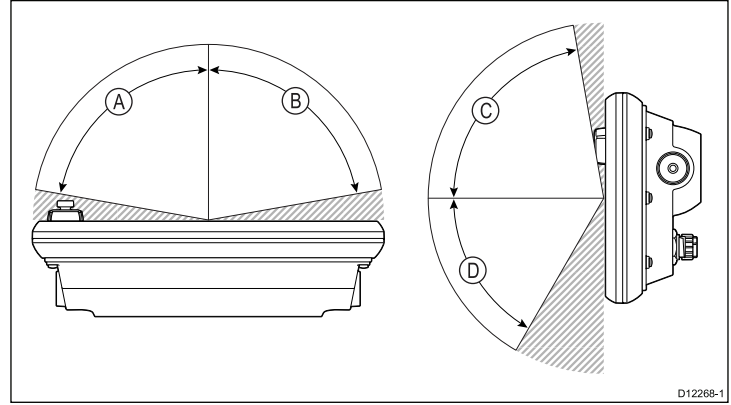

	e7 / e7D	e95 / e97 / c95 / c97	e125 / e127 / c125 / c127	e165
A	70°	80°	80°	80°
B	70°	80°	80°	80°
C	70°	80°	80°	70°
D	50°	60°	60°	70°

Note: The angles stated are for a contrast ratio of equal to or greater than 10.

Product dimensions

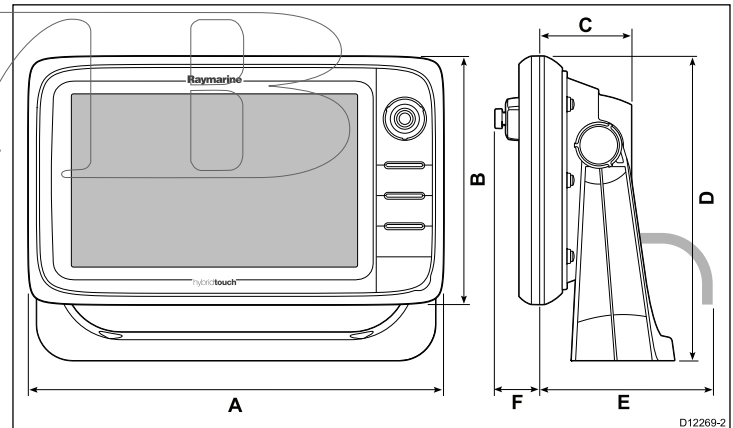

	e7 / e7D	e95 / e97 / c95 / c97	e125 / e127 / c125 / c127	e165
A	233 mm (9.17 in.)	290 mm (11.42 in.)	354 mm (13.94 in.)	426 mm (16.8 in.)
B	144 mm (5.67 in.)	173 mm (6.81 in.)	222 mm (8.74 in.)	281.4 mm (11.1 in.)
C	63.5 mm (2.5 in.)	64 mm (2.52 in.)	69 mm (2.72 in.)	68.4 mm (2.7 in.)
D	180 mm (7.09 in.)	212 mm (8.35 in.)	256.5 mm (10.1 in.)	295 mm (11.6 in.)
E	160 mm (6.29 in.)	160 mm (6.29 in.)	160 mm (6.29 in.)	176.6 mm (7 in.)
F	30 mm (1.18 in.)	31.4 mm (1.24 in.)	32 mm (1.26 in.)	33 mm (1.3 in.)

Removing the rear bezel

You must remove the rear bezel before flush-mounting the display.

Note: These steps do not apply to the e165 as it does not require a rear bezel.

1. Remove the front bezel. Refer to the separate instructions provided for that procedure.

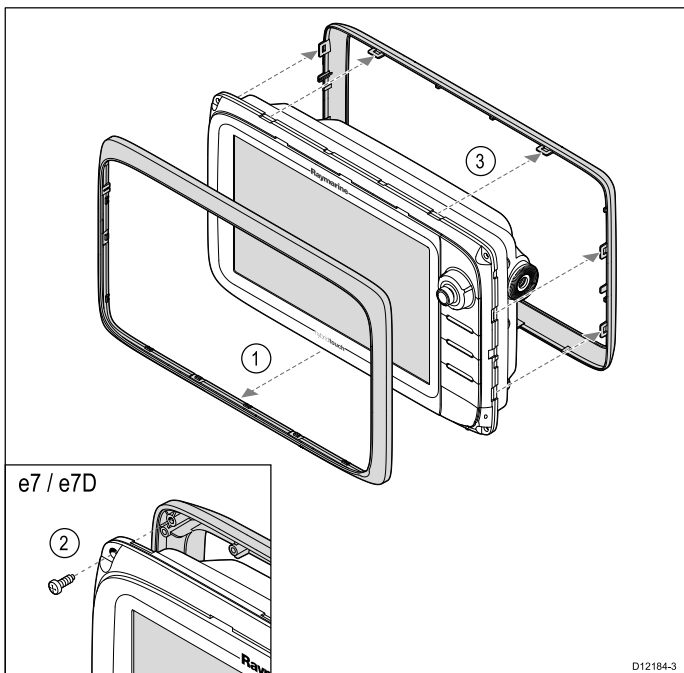

2. Remove the screws that secure the bezel to the display (only required for e7 and e7D).
3. Carefully remove the bezel from the rear of the display, pulling the bezel gently along the:
 - i. Outer edges - work from the sides upwards and then along the top edge, ensuring that the clips are fully released from the display.
 - ii. Inner edges - ensure that the bezel is completely removed from the display.

Note: Only the e7 and e7D have fixing screws for the rear bezel, other multifunction display variants have clips which hold the rear bezel in place.

Flush mounting

You can mount the display in a flush or panel mounting arrangement. Before mounting the unit, ensure that you have:

- Selected a suitable location.
- Identified the cable connections and route that the cables will take.
- Detached the front bezel.

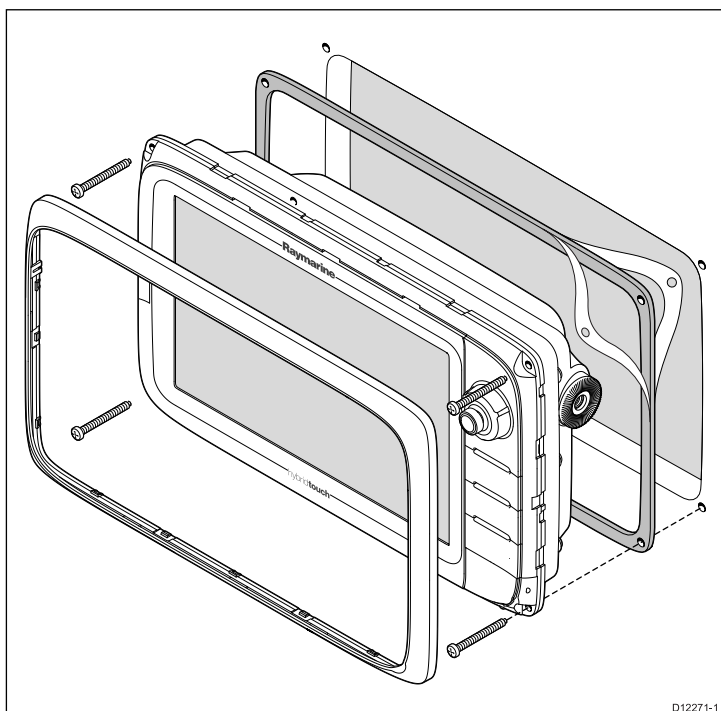

1. Check the selected location for the unit. A clear, flat area with suitable clearance behind the panel is required.
2. Fix the appropriate cutting template supplied with the product, to the selected location, using masking or self-adhesive tape.
3. Using a suitable hole saw (the size is indicated on the template), make a hole in each corner of the cut-out area.
4. Using a suitable saw, cut along the inside edge of the cut-out line.
5. Ensure that the unit fits into the removed area and then file around the rough edge until smooth.
6. Drill 4 holes as indicated on the template to accept the securing screws.
7. Place the gasket onto the display unit and press firmly onto the flange.
8. Connect the power, data and other cables to the unit.
9. Slide the unit into place and secure using the provided screws.

Note: The appropriate torque to use when drilling depends on the thickness of the mounting surface and the type of material.

Note: The supplied gasket provides a seal between the unit and a suitably flat and stiff mounting surface or binnacle. The gasket should be used in all installations. It may also be necessary to use a marine-grade sealant if the mounting surface or binnacle is not entirely flat and stiff or has a rough surface finish.

Attaching the rear bezel

The rear bezel must be fitted if you wish to use a mounting bracket to mount the unit.

Note: These steps do not apply to the e165 as it does not require a rear bezel.

1. Remove the front bezel. Refer to the separate instructions provided for that procedure.
2. Place the bezel over the rear of the display, ensuring that it is correctly aligned with the display. Apply firm but even pressure to the bezel along the:
 - i. Outer edges - work from the sides upwards and then along the top edge, to ensure that it clips securely into position.
 - ii. Inner edges - ensure that the bezel sits flat against the unit.

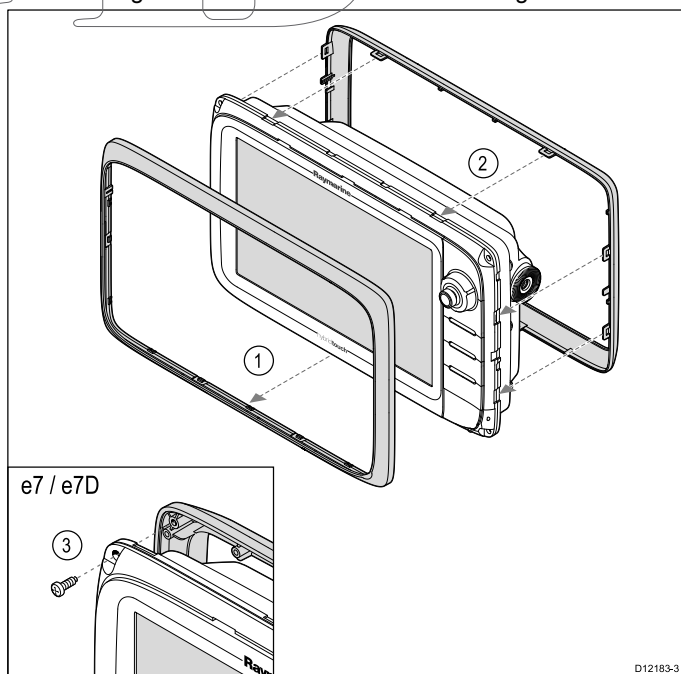

3. Use the supplied screws to secure the bezel to the display (e7 and e7D only).

Bracket (trunnion) mounting

The display can be mounted on a trunnion bracket.

Note: The mounting bracket is supplied with the e7 and e7D display variants, for all other display variants the mounting bracket is an optional accessory. See the *Spares and Accessories* section of this manual for details.

Before mounting the unit ensure that you have:

- Selected a suitable location.
- Identified the cable connections and route that the cables will take.
- Attach the front bezel.

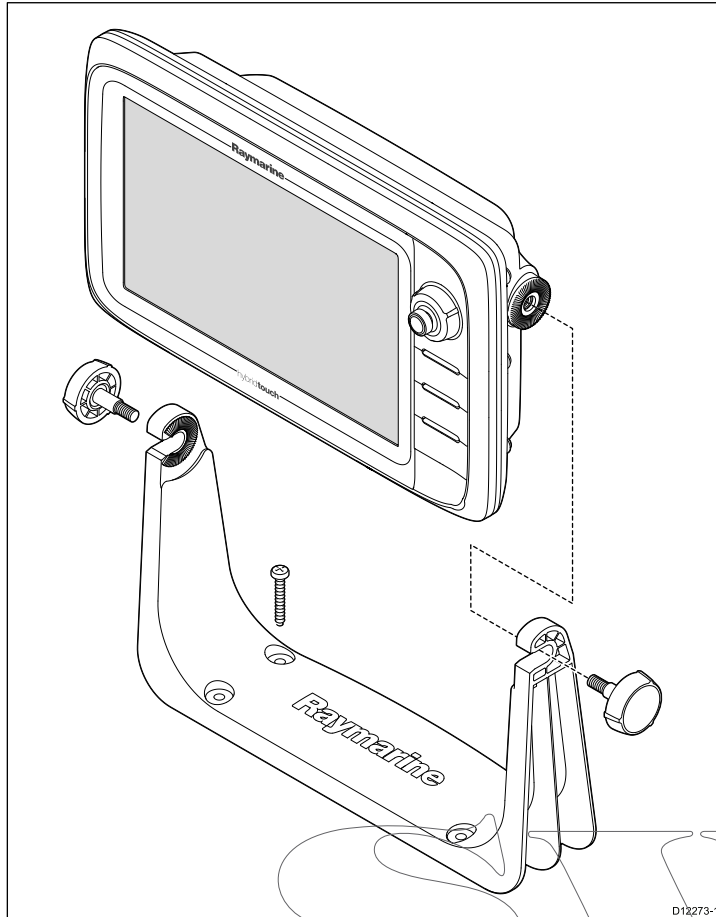

1. Mark the location of the mounting bracket screw holes on the chosen mounting surface.
2. Drill holes for the screws using a suitable drill, ensuring there is nothing behind the surface that may be damaged.
3. Use the screws supplied with the mounting bracket to attach securely.
4. Attach the display unit to the mounting bracket.

Note: The appropriate torque to use when drilling depends on the thickness of the mounting surface and the type of material.

Front bezel

Attaching the front bezel

The following procedure assumes that the unit has already been mounted in position.

1. Carefully lift one edge of the screen protection film, so that it is accessible for removing when unit installation is complete.
2. Ensure the memory card slot door is in the open position.
3. Orientate the bottom-right side of the bezel under the lip of the chart card door and place the bezel over the front of the display,

ensuring that the clips along the bottom edge of the bezel latch into position.

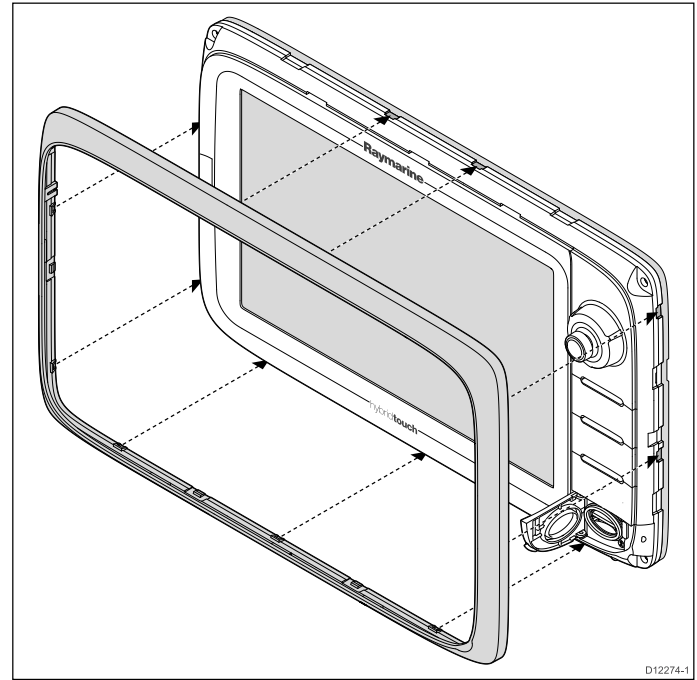

4. Ensure the bezel is correctly aligned with the display, as shown.
5. Apply firm but even pressure to the bezel along the:
 - i. Outer edges - work from the sides upwards and then along the top edge, to ensure that it clips securely into position.
 - ii. Inner edges - particularly along the chart card door edge, to ensure that the bezel sits flat.
6. Check that all control buttons are free to operate.

Removing the front bezel

Before proceeding ensure the memory card slot door is open.

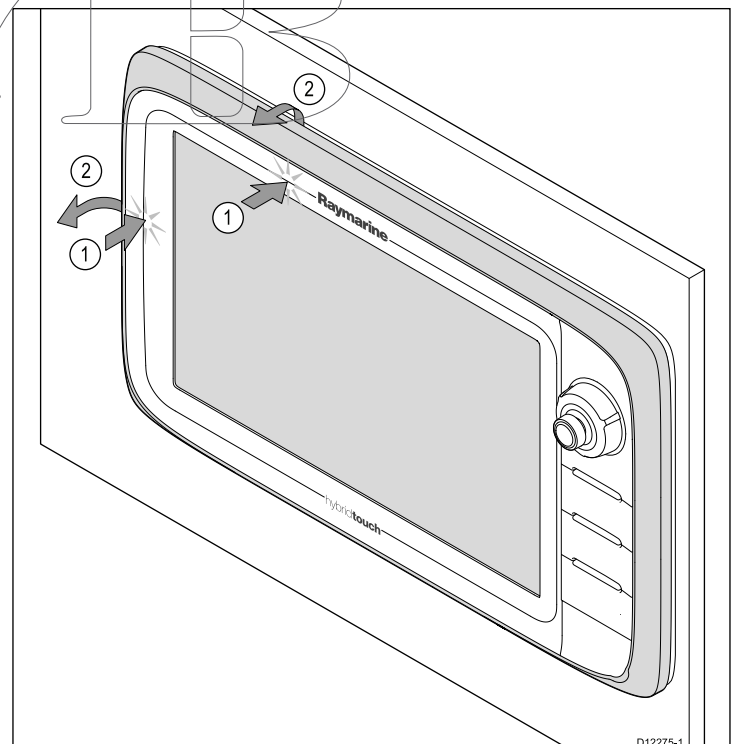

Important: Use care when removing the bezel. Do not use any tools to lever the bezel; doing so may cause damage.

1. Place both your thumbs on the upper left edge of the display, at the positions indicated in the diagram above.
2. Place your fingers underneath the bezel, at the positions indicated in the diagram above.
3. In a single firm motion, apply pressure to the outer edge of the display with your thumbs and pull the bezel towards you using your fingers.

The bezel should now come away from the display easily.

SWIB

Chapter 6: Getting started

Chapter contents

- [6.1 Display power on page 66](#)
- [6.2 New a Series Controls on page 66](#)
- [6.3 e7 / e7D Controls on page 67](#)
- [6.4 c95 / c97 / c125 / c127 / e95 / e97 / e125 / e127 / e165 Controls on page 67](#)
- [6.5 Hybridtouch overview on page 69](#)
- [6.6 Touchscreen overview on page 69](#)
- [6.7 Homescreen overview — New a Series on page 70](#)
- [6.8 Homescreen overview — New c Series / New e Series on page 70](#)
- [6.9 System checks on page 71](#)
- [6.10 Enabling autopilot functions on page 74](#)
- [6.11 Enabling AIS functions on page 74](#)
- [6.12 Language selection on page 75](#)
- [6.13 Pages on page 75](#)
- [6.14 Applications on page 76](#)
- [6.15 Splitscreen controls on page 77](#)
- [6.16 Screen overview on page 78](#)
- [6.17 Editing information in dialogs on page 80](#)
- [6.18 Editing numerical settings on page 81](#)
- [6.19 Basic touchscreen operations on page 81](#)
- [6.20 Databar status symbols on page 82](#)
- [6.21 Initial set up procedures on page 83](#)

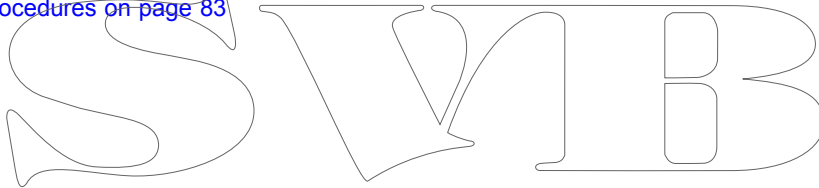

6.1 Display power



Powering the display on

1. Press and hold the **POWER** button until the Raymarine logo appears.
2. Select **Accept** to acknowledge the disclaimer message.



Powering the display on

1. Press and hold the **POWER** button until the Raymarine logo appears.
2. Press the **OK** button to accept the disclaimer message.

Powering the display off

1. Press and hold the **POWER** button until the countdown reaches zero.

Note: If the **POWER** button is released before the countdown reaches zero, the power off is cancelled.

Standby (PowerSave) mode

In PowerSave mode all functions of the multifunction display remain active, but the unit is placed into a low power state. The LED lights around the Rotary controller will blink once every 1.5 seconds to indicate that the unit is in PowerSave mode. PowerSave mode is cancelled by pressing a physical button or when an alarm event occurs.

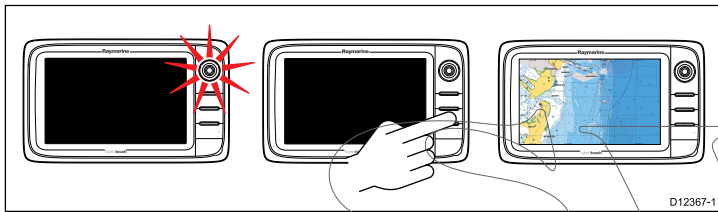

Note: To ensure user safety the PowerSave feature will not be available if any connected radars are switched on.

Enabling PowerSave mode

To enable PowerSave mode follow the steps below.

1. Ensure any radars connected to the system are switched off.
2. Press the **POWER** button.
The shortcuts menu is displayed.
3. Select **PowerSave Mode**.
The multifunction displays is now in PowerSave mode.
4. You can wake the unit from PowerSave mode at anytime by pressing a physical button on the multifunction display.

Note: PowerSave mode is automatically cancelled if an alarm event occurs.

6.2 New a Series Controls

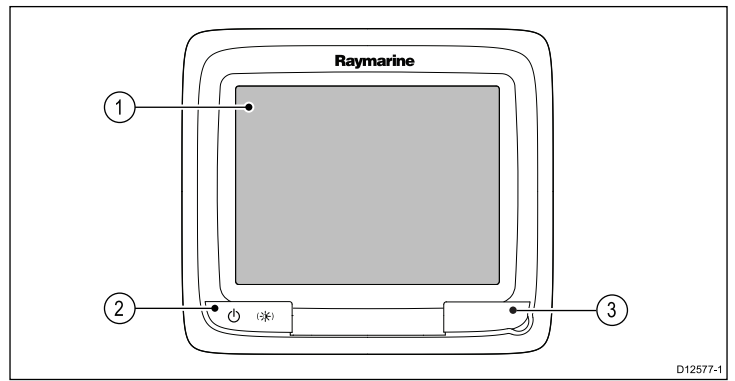

1. **Touchscreen** — touch the screen to operate functions, including all menu operations.
2. **Power** — press once to switch the unit ON. Once powered on, press the Power button again to adjust the brightness, perform a screen capture, access Powersave mode or access the power controls for external devices. Press and hold to switch the unit OFF.
3. **Chart card slot** — open the card door to insert or remove an MicroSD card. There is 1 card slot, used for electronic charts and archiving waypoint, route and track data.

6.3 e7 / e7D Controls

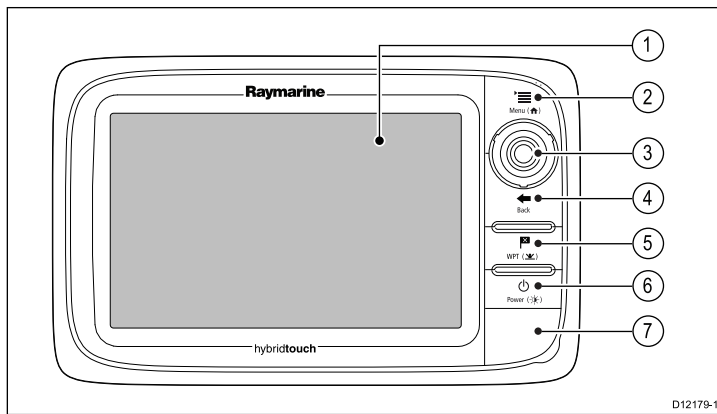

1. **Touchscreen** — you can touch the screen to operate many common functions, including all menu operations (HybridTouch multifunction displays only).
2. **Menu** — accesses menus. Press again to close menus.
3. **UniControl** — provides a joystick and rotary control and an OK button for using menus and applications.
4. **Back** — press to return to a previous menu or dialog level.
5. **WPT / MOB** — press and release to access the waypoint options. Press again to place a waypoint. Press and hold to place a Man Overboard (MOB) marker at your current position.
6. **Power** — press once to switch the unit ON. Once powered on, press the Power button again to adjust the brightness, access the power controls for external devices, and access the autopilot controls. Press and hold to switch the unit OFF.
7. **Chart card slots** — open the card door to insert or remove MicroSD cards. There are 2 card slots (labelled 1 and 2), used for electronic charts and archiving waypoint, route and track data.

6.4 c95 / c97 / c125 / c127 / e95 / e97 / e125 / e127 / e165 Controls

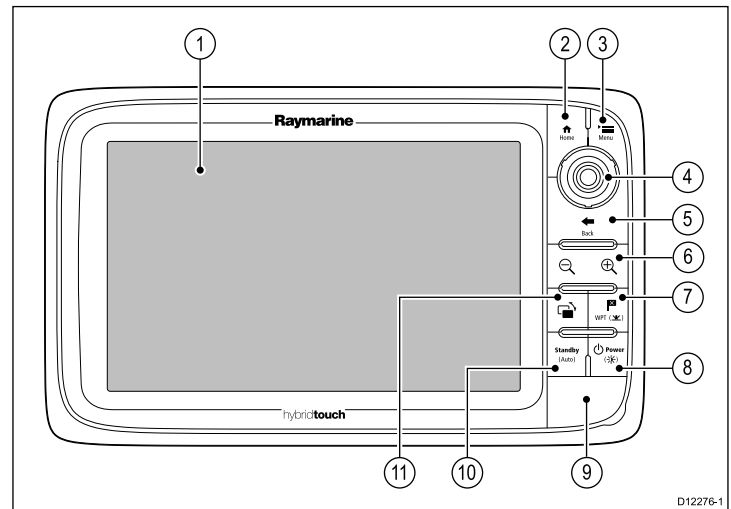

1. **Touchscreen** — you can touch the screen to operate many common functions, including all menu operations (HybridTouch multifunction displays only).
2. **Home** — Press to return to the homescreen.
3. **Menu** — accesses menus. Press again to close menus.
4. **UniControl** — provides a joystick and rotary control and an OK button for using menus and applications.
5. **Back** — press to return to a previous menu or dialog level.
6. **Range In/Out** — Press minus (-) to range out and plus (+) to range in
7. **WPT / MOB** — press and release to access the waypoint options. Press again to place a waypoint. Press and hold to place a Man Overboard (MOB) marker at your current position.
8. **Power** — press once to switch the unit ON. Once powered on, press the Power button again to adjust the brightness, access the power controls for external devices, and access the autopilot controls. Press and hold to switch the unit OFF.
9. **Chart card slots** — open the card door to insert or remove MicroSD cards. There are 2 card slots (labelled 1 and 2), used for electronic charts and archiving waypoint, route and track data.
10. **Standby (Auto)** — Press to disengage integrated autopilot, press and hold to activate Auto mode on integrated autopilot.
11. **Switch Active Pane** — Press to switch the active pane.

UniControl

New c Series and New e Series display include a UniControl which consists of Rotary, Joystick and push button controls.

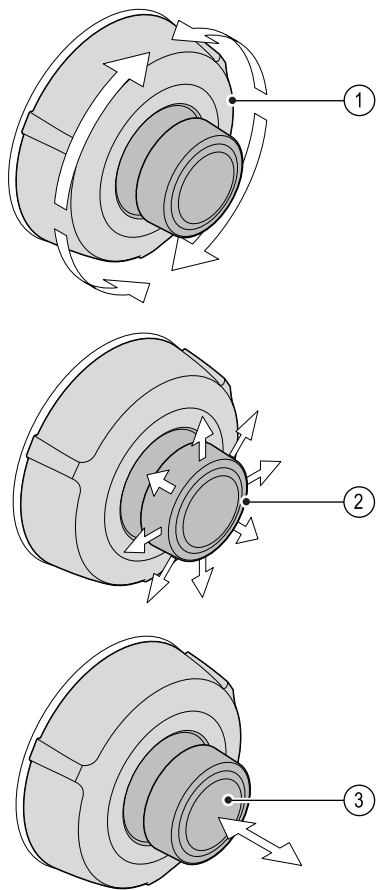

D12180-1

1. **Rotary** — use this to select menu items, move the on-screen cursor, and adjust the range in the chart and radar applications.
2. **Joystick** — use this to move the cursor position in applications, pan up, down, left and right in the chart, weather and fishfinder applications or to cycle through datapages in the data application.
3. **OK button** — push the end of the joystick to confirm a selection or entry.

Touch icons

Touchscreen multifunction displays can use the **BACK** and **CLOSE** icons to move between the different levels of menus available in each application.

	Back — go back one level (same effect as pressing the BACK button).
	Close — close all open menus (same effect as pressing the MENU button).

Using the cursor

The cursor is used to move around the screen.

	The cursor appears on the screen as a white cross.
	If the cursor has not been moved for a short period of time, it changes to a circle with a cross in it, to make it easier to locate on the screen.
	The cursor is context-sensitive. When it is placed over an object such as a waypoint or chart feature, it changes color and a label or information associated with the object is displayed.

List of cursor labels

Label	Feature	Application
A/B	Ruler line	Chart
AIS	AIS target	Chart
COG	Course Over Ground vector	Chart
CTR	Center of radar	Radar
FLT	Floating EBL/VRM	Radar
GRD	Guard zone	Radar
HDG	Heading vector	Chart
MARPA	MARPA target	Radar
MOB	Man Over Board marker	Chart, Radar
POS	Vessel's position	Chart
RTE	Route leg	Chart
SHM	Ship's Heading Marker	Radar
TIDE	Tide indicator	Chart
TRACK	Track line	Chart
VRM/EBL	VRM and EBL, 1 or 2	Radar
WIND	Wind indicator	Chart
WPT	Waypoint	Chart, Radar

6.5 Hybridtouch overview

If your multifunction display features Hybridtouch, this enables you to operate the unit using the touchscreen and the physical keys.

All functions can be accessed using the touchscreen. However, there may be situations (such as rough sea conditions) when it is not appropriate to use the touchscreen. In these situations, Raymarine strongly recommends that you activate the touch lock and use the physical keys to operate your multifunction display.

6.6 Touchscreen overview

The touchscreen provides an alternative to using physical buttons to control your multifunction display.

All functions can be accessed using the touchscreen

Note: Raymarine strongly recommends that you familiarize yourself with touch operations while your vessel is anchored or moored. You may find it helpful to use the simulator mode (accessible from **Homescreen > Set-up > System Settings**) in these situations.

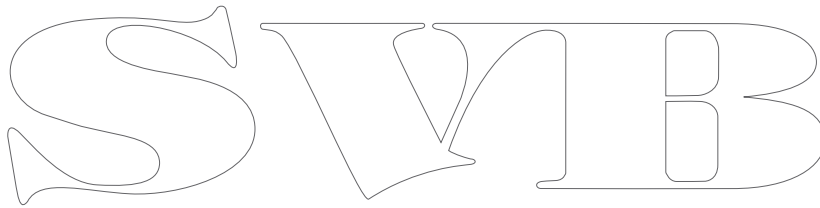
The logo for Raymarine SVMB, consisting of the letters 'S', 'V', 'M', and 'B' in a stylized, outlined font. The 'S' is on the left, followed by 'V', 'M', and 'B' on the right. The letters are interconnected and have a classic, serif-like appearance.

6.7 Homescreen overview — New a Series

The homescreen provides a central point of access to your display's range of applications.

- The homescreen also provides quick access to your data (waypoints, routes, and tracks).
- The homescreen consists of a number of application "pages", each represented by an icon. Applications can be started by selecting the relevant page icon.
- Swipe the screen with your finger to scroll the homescreen and access additional application pages.

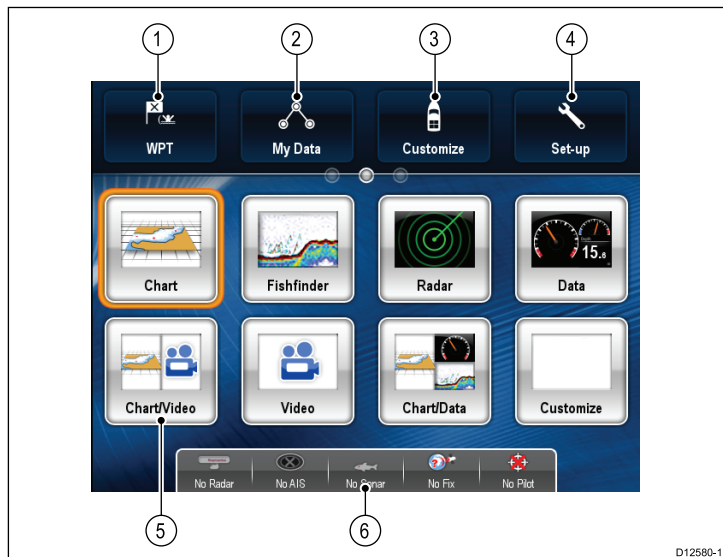

D12580-1

Screen item	Description
1	Waypoint — select icon to access the waypoint list. Select and hold on icon to place a Man Overboard (MOB) marker at your vessel's current position.
2	My Data — this icon enables you to centrally manage your lists of routes, tracks, and waypoints.
3	Customize — select this icon to configure application pages and select the display's language, units, date/time, boat details and display preferences.
4	Set-up — select this icon to access the system set-up menus.
5	Page — each icon represents an application page. A page can display up to 2 applications simultaneously.
6	Status bar — the status icons confirm the status of externally-connected equipment, including GPS, AIS, radar, and autopilot units.

6.8 Homescreen overview — New c Series / New e Series

The homescreen provides a central point of access to your display's range of applications.

- The homescreen also provides quick access to your data (waypoints, routes, and tracks).
- The homescreen consists of a number of application "pages", each represented by an icon. Applications can be started by selecting the relevant page icon.
- Use the joystick or swipe the screen with your finger (New e Series only) to scroll the homescreen and access additional application pages.

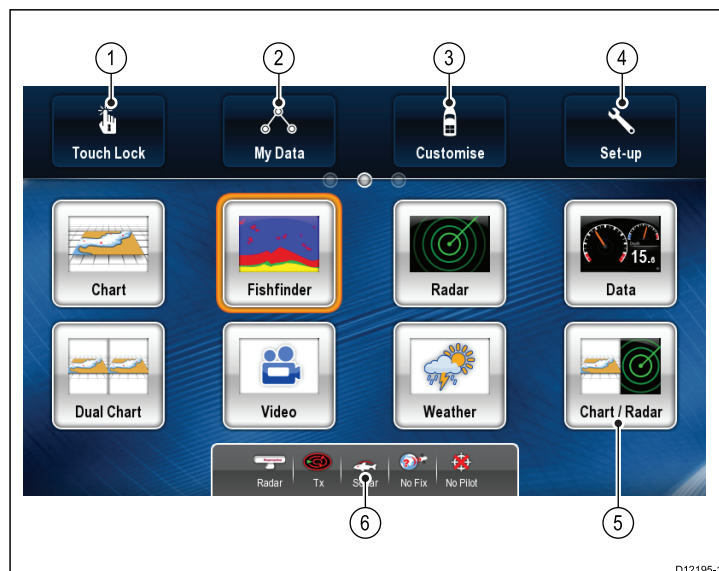

D12195-1

Screen item	Description
1	Touch Lock — (HybridTouch displays only) select this icon to lock the touchscreen, preventing accidental use. To unlock, use the UniControl to deselect the Touch Lock icon.
2	My Data — this icon enables you to centrally manage your lists of routes, tracks, and waypoints.
3	Customize — select this icon to configure application pages and select the display's language, units, date/time, boat details and display preferences.
4	Set-up — select this icon to access the system set-up menus.
5	Page — each icon represents an application page. A page can display up to 2 applications simultaneously.
6	Status bar — the status icons confirm the status of externally-connected equipment, including GPS, AIS, radar, and autopilot units.



Accessing the homescreen

The homescreen can be accessed from any application.

To access the homescreen follow the steps below:

1. Select the homescreen icon on-screen.



Accessing the homescreen

The homescreen can be accessed from any application.

To access the homescreen follow the steps below:

1. Press the **Home** button.

Note: The e7 and e7D have a combined Menu and Home button, to access the homescreen press and hold the **Menu / Home** button for 3 seconds.

6.9 System checks

GPS Check

GPS selection

You can use an internal (if available) or external GPS receiver.

- Your multifunction display may feature an internal GPS receiver.
- You can also connect an external GPS receiver using SeaTalk^{ng} or NMEA 0183.
- Where appropriate use the System Settings menu to enable or disable the internal GPS receiver.

Enabling or disabling the internal GPS

If your multifunction display features an internal GPS then this can be enabled and disabled by following the steps below.

With the homescreen displayed:

- Select **Set-Up**.
- Select **System Settings**.
- To enable the internal GPS, select **Internal GPS** so that On is highlighted.
- To disable the internal GPS, select **Internal GPS** so that Off is highlighted.

Checking GPS operation

You can check that the GPS is functioning correctly using the chart application.

- Select the Chart page.

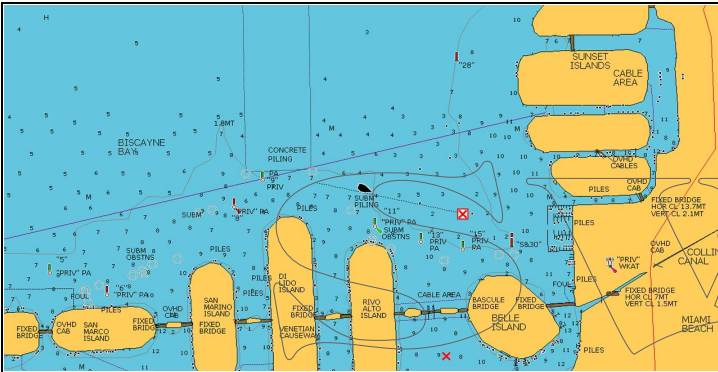

- Check the screen.

With the chart displayed, you should see:

Your boat position (indicates a GPS fix). Your current position is represented by a boat symbol or solid circle. Your position is also displayed in the data bar under VES POS.

A solid circle on the chart indicates that neither heading nor Course Over Ground (COG) data is available.

Note: Raymarine recommends that you check the displayed vessel position in the chart application against your actual proximity to a known charted object. GPS receivers typically have an accuracy of between 5 and 15 m.

Note: A GPS Status screen is available within the Setup menu of Raymarine multifunction displays. This provides satellite signal strength and other relevant information.

GPS setup

The GPS setup options enable you to configure a connected GPS receiver.

The Global Positioning System (GPS) is used to position your vessel on the chart. You can set up your GPS receiver and check its status from the GPS Status option in the **System Settings** menu. For each tracked satellite, the screen provides the following information:

- Satellite number.
- Signal strength bar.
- Status.
- Azimuth angle.
- Elevation angle.
- A sky-view to show the position of tracked satellites.

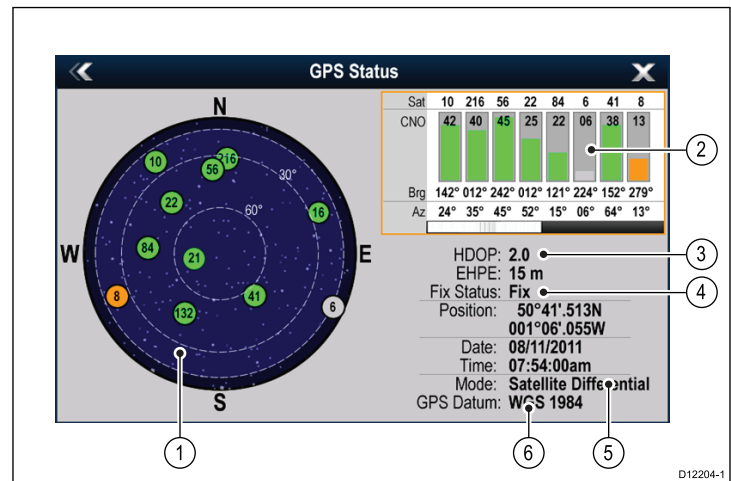

Item	Description
1	Sky view — a visual representation of the position of tracked satellites.
2	Satellite status — displays the signal strength and status of each satellite identified in the sky view diagram on the left of the screen. The colored bars have the following meanings: <ul style="list-style-type: none"> Grey = searching for satellite. Green = satellite in use. Orange = tracking satellite.
3	Horizontal Dilution of Position (HDOP) — a measure of GPS accuracy, calculated from a number of factors including satellite geometry, system errors in the data transmission and system errors in the GPS receiver. A higher figure signifies a greater positional error. A typical GPS receiver has an accuracy of between 5 and 15 m. As an example, assuming a GPS receiver error of 5 m, an HDOP of 2 would represent an error of approximately 15 m. Please remember that even a very low HDOP figure is NO guarantee that your GPS receiver is providing an accurate position. If in doubt, check the displayed vessel position in the chart application against your actual proximity to a known charted object.
4	Fix status — indicates the actual mode the GPS receiver is reporting (No Fix, Fix, D Fix or SD Fix).
5	Mode — the mode currently selected by the GPS receiver.
6	Datum — The GPS receiver's datum setting affects the accuracy of the vessel position information displayed in the chart application. In order for your GPS receiver and multifunction display to correlate accurately with your paper charts, they must be using the same datum.

The accuracy of the GPS receiver depends on the parameters detailed above, especially the azimuth and elevation angles which are used in triangulation to calculate your position.

Radar check

Warning: Radar scanner safety

Before rotating the radar scanner, ensure all personnel are clear.

Warning: Radar transmission safety

The radar scanner transmits electromagnetic energy. Ensure all personnel are clear of the scanner when the radar is transmitting.

Checking the radar

From the Radar application:

- Select **Menu**.
 - Select **Power** so that On is highlighted.
- The Radar scanner will now initialize in standby mode. This process will take approximately 70 seconds.

3. Select **Radar** so that Transmit is highlighted.
The radar scanner should now be transmitting and receiving.
4. Check that the radar screen is operating correctly.

Typical HD radar screen

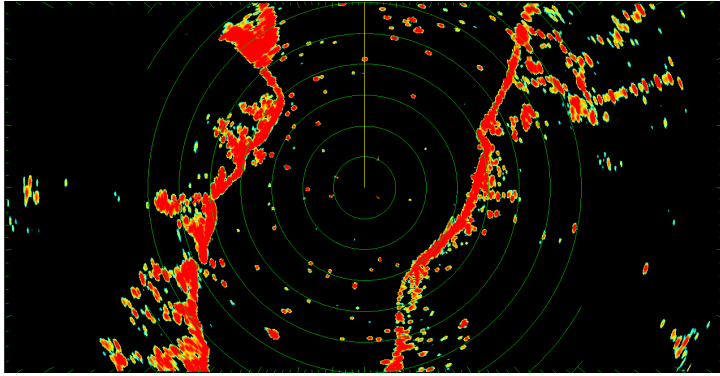

Note: The example above is representative of the enhanced output provided by a HD radar scanner.

Points to check:

- Radar sweep with echo responses are shown on screen.
- Radar status icon rotating in top right hand corner of the status bar.

Check and adjust bearing alignment

Bearing alignment

The radar bearing alignment ensures that radar objects appear at the correct bearing relative to your boat's bow. You should check the bearing alignment for any new installation.

Example misaligned radar

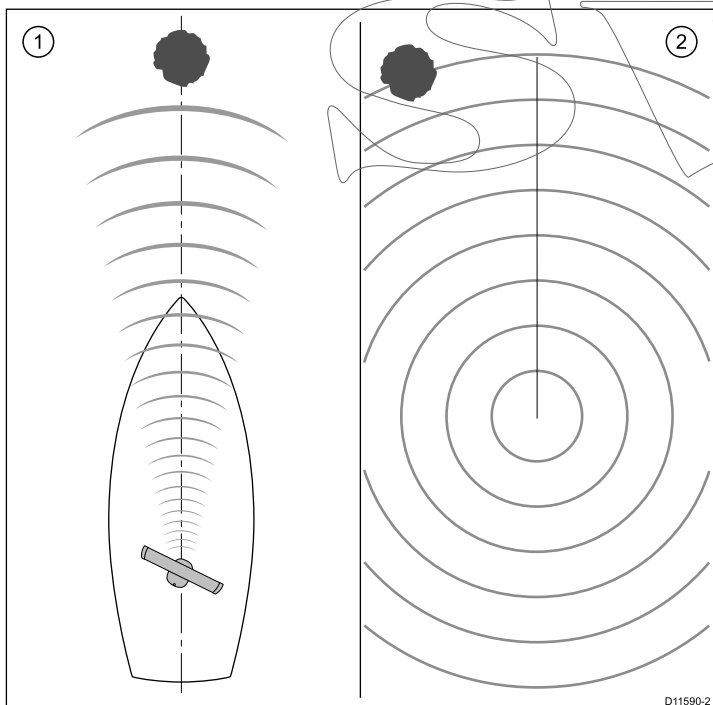

Item	Description
1	Target object (such as a buoy) dead ahead.
2	Target displayed on the radar display is not aligned with the Ship's Heading Marker (SHM). Bearing alignment is required.

Checking the bearing alignment

1. With your vessel under way: Align the bow with a stationary object identified on the radar display. An object between 1 & 2 NM distant is ideal.
2. Note the position of the object on the radar display. If the target is not under the ship's heading marker (SHM), there is an alignment error and you will need to carry out bearing alignment adjustment.

Adjusting the bearing alignment

Once you have checked the bearing alignment you can proceed and make any required adjustments.

With the radar application displayed:

1. Select **Menu**.
2. Select **Scanner Set-up**.
3. Select **Advanced**.
4. Select **Bearing Alignment**.
Selecting Bearing Alignment displays the numeric adjust control.
5. Adjust the setting so that the selected target is under the Ship's Heading Marker.
6. Select **Back** or **Ok** when complete.

Sonar check



Warning: Sonar operation

- NEVER operate the sonar with the vessel out of the water.
- NEVER touch the transducer face when the sonar is powered on.
- SWITCH OFF the sonar if divers are likely to be within 7.6 m (25 ft) of the transducer.

Sonar transducer and sonar module selection

You must designate the sonar transducer and Sonar module that you want to use.

Sonar module selection

- Sonar variant displays are fitted with an internal sonar.
- All variants allow you to connect a compatible sonar module.
- If an external sonar module is connected to a sonar variant display and a power supply the internal sonar should be switched off.
- To use a display's internal sonar on a system containing an external sonar module, disconnect the network cable from the external sonar module and use the **Sounder Set-Up** menu in the fishfinder application to enable the internal sonar.

Transducer selection

- Sonar variant displays allow the direct connection of EITHER a Raymarine OR a Minn Kota sonar transducer.
- All variants allow the connection of a Raymarine sonar transducer via a compatible external sonar module.
- For all variants use the **Transducer Set-Up** menu in the fishfinder application to specify the sonar transducer you want to use.

Selecting the sonar module

Sonar variant multifunction displays can use either their internal sonar module or an external Raymarine sonar module.

Applicable only to sonar variant multifunction displays.

With the fishfinder application displayed:

1. Select **Menu**.
2. Select **Set-Up**.
3. Select **Sounder Set-Up**.
4. To use the internal sonar module select **Internal Sounder** so that On is highlighted.
5. To use a connected external Raymarine sonar module select **Internal Sounder** so that Off is highlighted.

Note: The Internal Sounder cannot be switched on if an external sonar module is connected to the system and switched on. Disconnect the network cable from the external sonar module to enable the display's internal sonar option.

Selecting the sonar transducer

With the fishfinder application displayed:

1. Select **Menu**.
2. Select **Set-Up**.

3. Select **Transducer Set-Up**.
4. Select **Transducer**.
A list of transducers is displayed.
5. Select the transducer you want to use.

Checking the sonar

Sonar checks are made using the fishfinder application.

1. Select the fishfinder page.

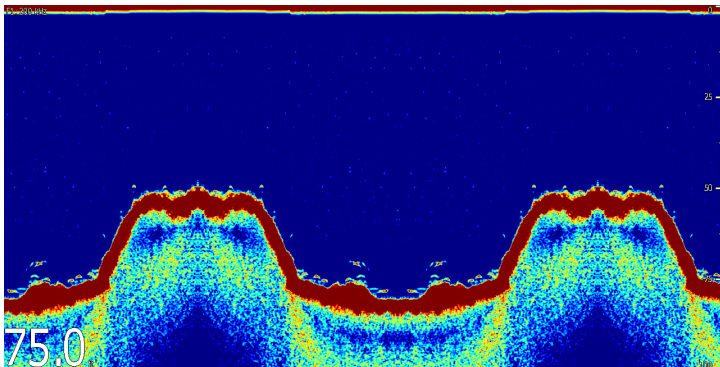

2. Check the fishfinder display.

With the fishfinder active you should see:

- Depth reading (indicates the transducer is working). The depth is shown in large white numbers at the bottom left of the screen.

Thermal camera setup and checks

To ensure correct operation of the thermal camera you should setup and check the camera's main functions.

Before proceeding ensure that the camera is connected correctly, according to the instructions provided. If your system includes the optional Joystick Control Unit (JCU) and PoE (Power over Ethernet) injector, ensure these units are also connected correctly.

Set up the camera

You will need to:

- Adjust the image (aspect ratio, contrast, brightness, and so on).

Check the camera

You will need to:

- Check the camera movement (pan, tilt, zoom).
- Check the camera "home" position is appropriate.

Adjusting the thermal camera image

With the thermal camera application displayed:

1. Select **Menu**.
2. Select **Adjust Contrast**.
3. Select the Contrast, Brightness, or Color option as appropriate.
The relevant numeric adjust control is displayed.
4. Adjust the value as required.
5. Select **Back** or **OK** to confirm the new value.



Panning and tilting, and the thermal image

On a New e Series multifunction display you can pan and tilt the thermal camera image using the touchscreen.

	<p>Move your finger up and down the screen to tilt the camera up or down.</p>
	<p>Move your finger left and right on the screen to rotate the camera left or right (panning).</p>



Panning, Tilting and zooming the thermal image

On New c Series and New e Series multifunction displays you can pan, tilt and zoom the thermal camera image using the physical buttons.

In some circumstances it may be better to use just the UniControl's rotary and joystick controls to manipulate the thermal camera view. For example, this method is ideal for finer control over the camera and is particularly useful in rough sea conditions.

	<p>UniControl joystick — is used for rotating the camera left or right (panning), or tilting the camera up or down.</p>
	<p>UniControl rotary — is used to zoom in and out.</p>

Note: Only the Uni-control can be used on a New c Series display to pan, tilt and zoom the thermal image.

Resetting the thermal camera to the home position

In the thermal camera application:

1. Select **Menu**.
2. Select **Camera Home**.
The camera returns to its currently defined home position, and the "Home" icon appears on-screen momentarily.

6.10 Enabling autopilot functions

With the homescreen displayed:

1. Select **Set-up**.
2. Select **System Settings**.
3. Select **Autopilot Control** so that On is highlighted.
Selecting Autopilot Control switches the control On and Off.
4. Select **Back** to return to the **System Settings** menu.
5. Select **Pilot Controls**.
If this menu option is disabled, no autopilot has been found.
Check the physical connections, then repeat steps 1 to 5 above.
6. The Pilot Control dialog is displayed, indicating that pilot control is enabled and an autopilot is detected.

6.11 Enabling AIS functions

Before proceeding ensure your AIS unit is connected to NMEA Port 1.

With the homescreen displayed:

1. Select **Set-Up**.
2. Select **System Settings**.
3. Select **NMEA Set-Up**.
4. Select **NMEA Input Port 1**.
5. Select the AIS 38400 option.
6. Select **Back** to return to the **System Settings** menu.
7. Select **External Devices**.
8. Select **AIS Unit Set-up**.
The AIS Unit Set-up menu is displayed.
9. Adjust the AIS options as appropriate.

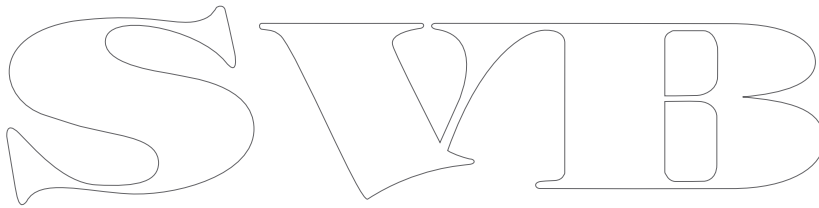
The logo consists of the letters 'S', 'V', 'T', 'I', and 'B' in a stylized, outlined font. The 'S' is on the left, followed by 'V', 'T', 'I', and 'B' on the right. The letters are interconnected and have a decorative, slightly irregular appearance.

6.12 Language selection

The system can operate in the following languages:

English (US)	English (UK)	Arabic
Chinese	Croatian	Danish
Dutch	Finnish	French
German	Greek	Italian
Japanese	Korean	Norwegian
Polish	Portuguese (Brazilian)	Russian
Spanish	Swedish	Turkish

With the homescreen displayed:

1. Select **Customize**.
2. Select **Language**.
3. Select from the languages available.

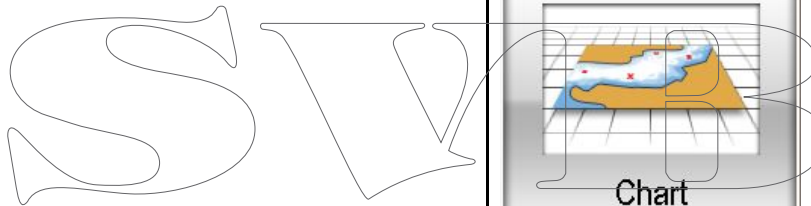



6.13 Pages

Pages are used to display applications.

Pages are displayed and accessed on the homescreen. Each page can display more than 1 application.

- You can set up and display up to 4 applications per page using a New c Series or New e Series (except for the e7 and e7D) multifunction display.
- The New a Series and the e7 / e7D multifunction displays can only set up and show up to 2 applications per page.
- ~The New a series and the e7 / e7D can however show up to 4 application per page if they are sharing the homescreen of a capable multifunction display which already has pages with up to 4 applications set up.

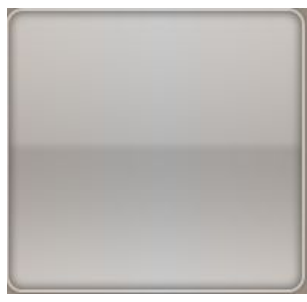
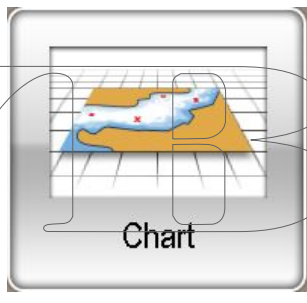
Any page on the homescreen can be customized, enabling you to group your applications into different pages, each designed for a specific purpose. For example, you could have a page that includes the chart and fishfinder applications, suitable for fishing, and another page that includes the chart and data applications, which would be suitable for general sailing.

	You can add any application(s) to any empty page.
	Page featuring a single application.
	Page featuring multiple applications.

You can also define a "layout" for each page, which determines how the applications are arranged on the screen.

Changing an existing page on the homescreen

With the homescreen displayed:

1. Select **Customize**.
2. Select **Homescreen**.
3. Select **Edit Page**.
4. Select the page icon that you want to change.
The Customize menu options are displayed.
5. Select the appropriate page layout (for example, "Splitscreen").
6. Select the application(s) you want to display on the page, either by selecting the relevant menu item or dragging it over to the displayed page.
7. Select **Finish**.
The Rename Page dialog is displayed.
8. Use the on-screen keyboard to name the page, then select **Save**.

Changing an empty page

With the homescreen displayed:

1. Select **Customize**.
2. Select **Homescreen**.
3. Select **Edit Page**.
4. Select an empty page icon (labelled "Customize").
The Customize menu options are displayed.
5. Select the appropriate page layout (for example, "Splitscreen").
6. Select the application(s) you want to display on the page, either by selecting the relevant menu item or dragging it over to the displayed page.
7. Select **Finish**.
The Rename Page dialog is displayed.
8. Use the on-screen keyboard to name the page, then select **Save**.

Moving a page on the homescreen

With the homescreen displayed:

1. Select the **Customize** icon.
2. Select **Homescreen**.
3. Select **Swap Page**.
4. Select the page icon that you want to move.
5. Select the page icon that you want to swap positions with.
The page icon is moved to the new position.

Renaming a page on the homescreen

With the homescreen displayed:

1. Select the **Customize** icon.
2. Select **Homescreen**.
3. Select **Rename Page**.
4. Select the page that you want to rename.
The on-screen keyboard is displayed.
5. Using the on-screen keyboard, enter the new name for the page.
6. Select **SAVE**.

Deleting a page from the homescreen

With the homescreen displayed:







1. Select the **Customize** icon.
2. Select **Homescreen**.
3. Select **Delete Page**.
4. Select the page that you want to delete.
The page is deleted.

Resetting the homescreen to default settings

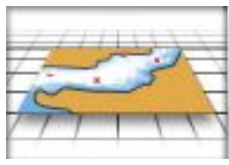
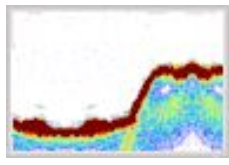
With the homescreen displayed:

1. Select the **Customize** icon.
2. Select **Homescreen**.
3. Select **Reset**.
A warning message is displayed asking for confirmation.
4. Select **Yes** to reset the homescreen to the default range of pages, or **No** to cancel the operation.

6.14 Applications

	Chart application — provides a 2D or 3D graphical view of your charts to help you navigate. Waypoint, route, and track functions enable you to navigate to a specific location, build and navigate routes, or record where you've been. Chart cards provide higher levels of detail and 3D views.
	Fishfinder application — with a transducer and a sonar variant multifunction display or compatible Sonar Module, you can use the fishfinder application to help you accurately distinguish between different sizes of fish, bottom structure, and underwater obstacles. You can also view sea depth and temperature data and mark points of interest such as fishing spots or wrecks.
	Radar application — with a suitable radar scanner, you can use the radar application to track targets and measure distances and bearings. A number of automatic gain presets and color modes are provided to help you get the best performance from your radar scanner.
	Data application — view system and instrument data on your multifunction display, for a range of compatible instruments. Use the joystick or touchscreen to scroll through the available data pages.
	Weather application — (North America only). With a suitable weather receiver connected to your system, the weather application overlays historical, live, and forecasted weather graphics on a world map.
	Thermal camera application — view and control a compatible thermal camera using your multifunction display. Note: The thermal camera application is not available on the New a Series multifunction displays.
	Video application — view a video or camera source on your multifunction display.
	Document Viewer — view pdf documents stored on an SD card.

6.15 Splitscreen controls

When viewing a page with more than 1 application displayed you can switch applications from the splitscreen view to fullscreen view.

Example 1 — Splitscreen page



Example 2 — Fishfinder application expanded to Fullscreen

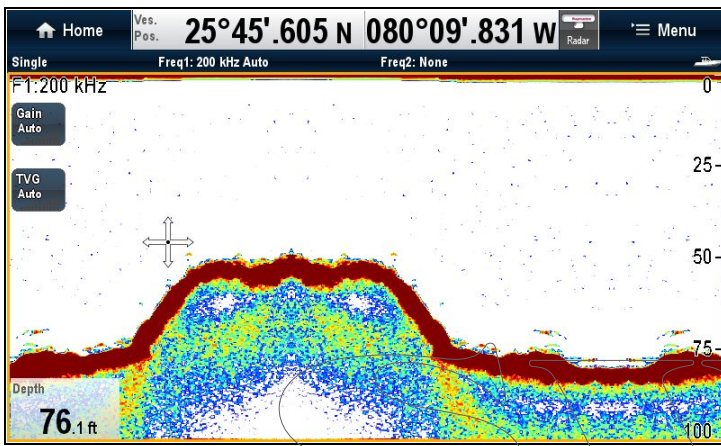

Selecting the active window — New a Series and e7 / e7D

When viewing a splitscreen page you can select the active application and view it fullscreen on a New a Series or e7 / e7D by following the steps below.

With a page featuring multiple applications displayed:

1. Touch anywhere inside the application you want to make active.
A border appears around the application, indicating that it is active.
2. Select **Menu**.
3. Select **Fullscreen** to view the active application in fullscreen, or
4. Select **Splitscreen** to return to the splitscreen view.

Selecting the active window — New c Series and New e Series

When viewing a splitscreen page you can select the active application and view it fullscreen on a New c Series or New e Series (excluding e7 / e7D) by following the steps below.

With a page featuring multiple applications displayed:

1. Press the  **Switch Active Pane** button.
The active pane pop up is displayed:
2. Press the **Switch Active Pane** button or use the **Rotary control** to cycle the active application.
3. Press the **Range in** or **Range out** buttons to switch the active application between splitscreen and fullscreen views.



Selecting the active window — e7 / e7D

When viewing a splitscreen page you can select the active application and view it fullscreen on an e7 / e7D with the touch lock enabled by following the steps below.

With a page featuring multiple applications displayed:

1. Press the **Menu** button.
2. Select **Cycle application**.
Selecting cycle application cycles through the available applications.
3. Select **Fullscreen** to view the active application in fullscreen, or
4. Select **Splitscreen** to return to the splitscreen view.

6.16 Screen overview

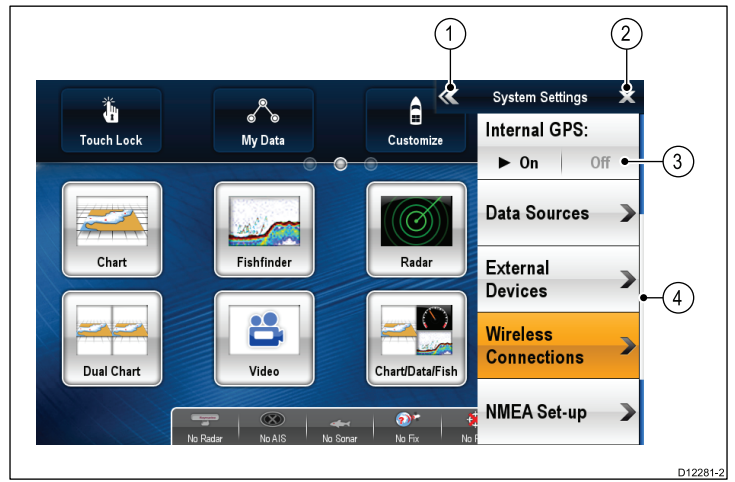
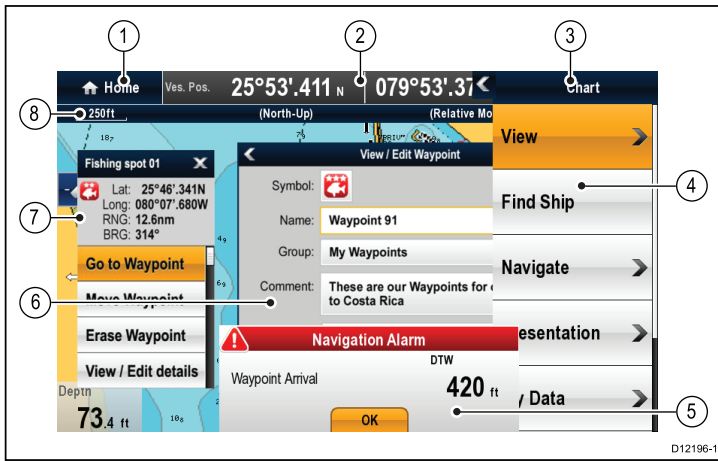

Screen item	Description
1	<p>Home</p> <ul style="list-style-type: none"> New a Series — Select the on-screen Home icon to access the homescreen. New c Series — Use the Home button to go back to the previous menu. e7 / e7D — Press and hold the Menu button for 3 seconds to access the homescreen. New e Series — Select the on-screen Home icon, or use the Home button to access the homescreen.
2	<p>Databar — provides information about your vessel and its environment. The position and type of information in the databar can be customized from the Homescreen > Customize > Databar Set-up menu, if required.</p>
3	<p>Menu — The menu options are specific to the application that you are currently using.</p>
4	<p>Pop-up menu — menu options are displayed when the Menu is selected.</p>
5	<p>Pop-up messages — alert you to a situation (such as an alarm), or unavailable function. Pop-up messages may require a response from you — for example, select OK to silence alarms.</p>
6	<p>Dialogs — enable data to be selected, edited or entered. Use in many common functions — for example, editing a waypoint.</p>
7	<p>Context menu — provides information and options specific to each application.</p>
8	<p>Status bar — provides information specific to each application. This information cannot be edited or moved.</p>

Screen item	Description
1	<p>Back — On touchscreen displays (New e Series and New a series) you can press the on-screen << (back) icon to go back to a previous menu. (On New c Series displays use the Back button.)</p>
2	<p>Close — On touchscreen displays (New e Series and New a series) you can press the on-screen X (close) icon to go back to a previous menu. (On New c Series displays use the Back button to back out of the menu structure.)</p>
3	<p>On / Off switch — On touchscreen displays (New e Series and New a series) you can select on-screen menu items to switch features On or Off to enable or disable the function. (On New c Series displays use the OK button to switch the function On or Off.)</p>
4	<p>Scroll bar — indicates that further menu items are available by scrolling the menu. On touchscreen displays (New e Series and New a series) to scroll through the available menu items, press and hold your finger on the menu and drag it up or down. (On New c Series displays use the Rotary control.)</p>

Using menu dialogs

Menu dialogs are full-screen menus that enable you to manage data items such as waypoints and routes.

The following diagram shows the main features of a standard menu:

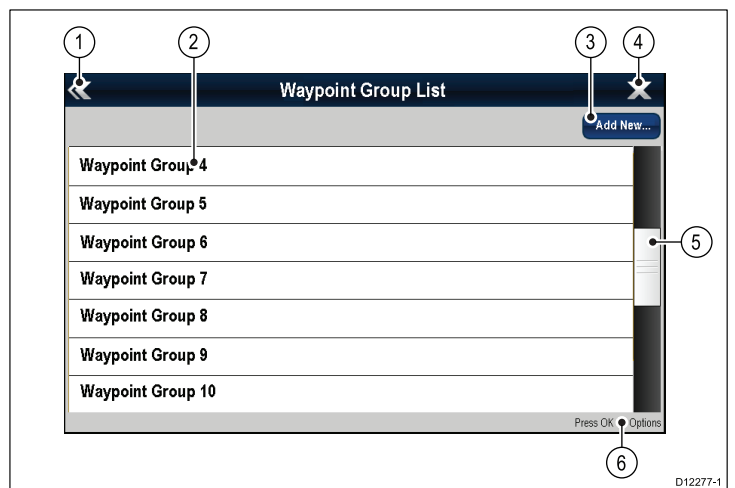

Using pop-up menus

Pop-up menus enable you to configure settings and preferences.

Menus are used in the:

- Homescreen** — to configure your multifunction display and externally-connected equipment.
- Applications** — to configure the settings for that particular application.

The following diagram shows the main features of a pop-up menu:

Screen item	Description
1	Back <ul style="list-style-type: none"> • Touchscreen — Select the on-screen Back icon to go back to the previous menu. • Non-touchscreen — Use the Back button to go back to the previous menu.
2	Menu item <ul style="list-style-type: none"> • Touchscreen — Momentarily touching a menu item highlights and automatically selects the item. To scroll a menu, touch a menu item and hold your finger down on the item while dragging your finger up or down • Non-touchscreen — Use the Rotary control to highlight an item, and the Ok button to select it. To scroll a menu, use the Rotary control.
3	Function icon — Some menu dialogs include an icon which can be selected to access additional functions. For example, in the Waypoint Group List menu dialog, the Add New icon can be used to add a new Waypoint group.
4	Close — On Touchscreen displays you can select this icon to close the menu(s). The close icon is not available on non-touchscreen displays.
5	Scroll bar <ul style="list-style-type: none"> • Touchscreen — To scroll through the available menu items, press and hold your finger on the menu to drag it up or down. • Non-touchscreen — To scroll through the available menu items, use the Rotary control.
6	Options — Select a menu item to access more options for that item. For example, in the Waypoint Group list you can select a menu item to view the waypoints in the group, edit the group name, or erase the group.

Using list dialogs

List dialogs are full-screen menus that display the details for specific types of data, such as Waypoints.

The following diagram shows the main features of a list dialog:

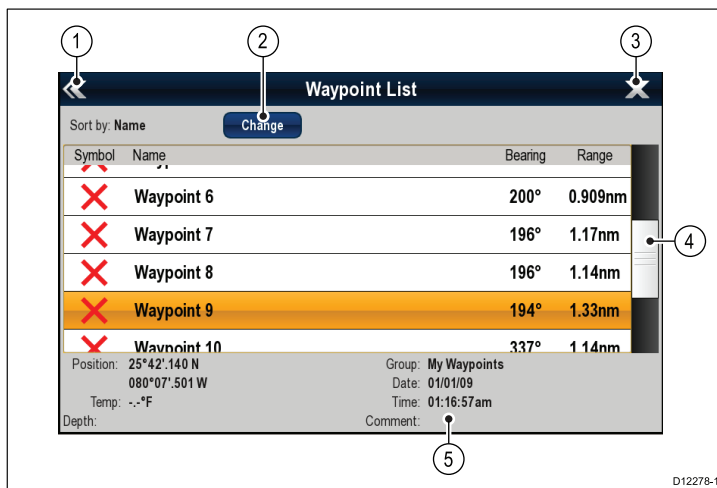

Screen item	Description
1	Back <ul style="list-style-type: none"> • Touchscreen — Select the on-screen Back icon to go back to the previous menu. • Non-touchscreen — Use the Back button to go back to the previous menu.
2	Sort icon — Some list dialogs include an icon which can be selected to sort the items in the list. For example, in the Waypoint List you can sort the list by name, range, group, symbol, and so on.

Screen item	Description
3	Close — On Touchscreen displays you can select this icon to close the menu(s). The close icon is not available on non-touchscreen displays.
4	Scroll bar <ul style="list-style-type: none"> • Touchscreen — To scroll through the available menu items, press and hold your finger on the menu to drag it up or down. • Non-touchscreen — To scroll through the available menu items, use the Rotary control.
5	Details — the details for a particular list item are displayed at the bottom of the dialog.

Using edit dialogs

Edit dialogs enable you to edit the details of data items stored on your multifunction display, such as waypoints, routes, and tracks.

The following diagram shows the main features of a typical edit dialog:

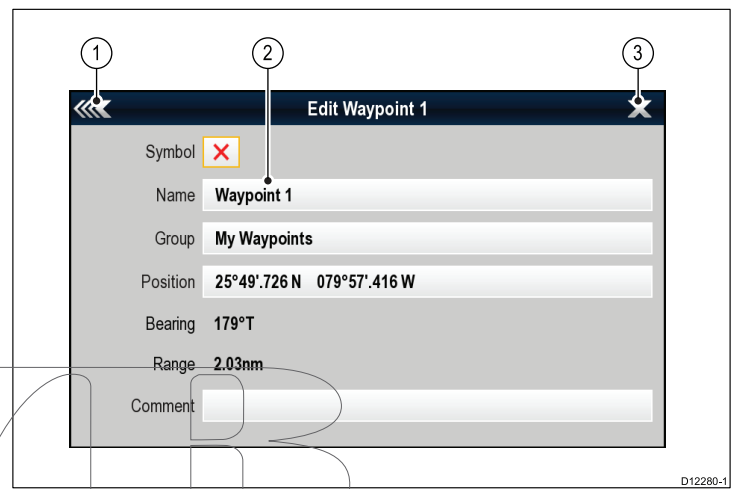

Screen item	Description
1	Back <ul style="list-style-type: none"> • Touchscreen — Select the on-screen Back icon to go back to the previous menu. • Non-touchscreen — Use the Back button to go back to the previous menu.
2	Field — Selecting a text field automatically displays the on-screen keyboard, which can be used to edit the details.
3	Close — On Touchscreen displays you can select this icon to close the menu(s). The close icon is not available on non-touchscreen displays.

Using control dialogs

Control dialogs enable you to control externally connected equipment, such as an autopilot unit.

The following diagram shows the main features of a typical control dialog:

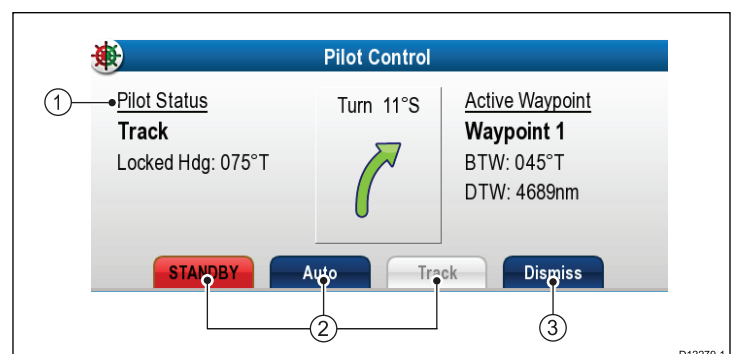

Screen item	Description
1	Status — provides status information for the connected equipment. For example, the Pilot Control dialog displays the locked heading and current navigation mode for a connected autopilot unit.
2	Control icons — provide direct control of the connected equipment. For example, the Pilot Control dialog Standby , Auto and Track icons enable you to instruct a connected autopilot unit to perform specific functions.
3	Dismiss — Closes the control dialog.

Using slider bar controls

Slider bar controls provide a graphical representation of numeric data and enables you to quickly change setting values.

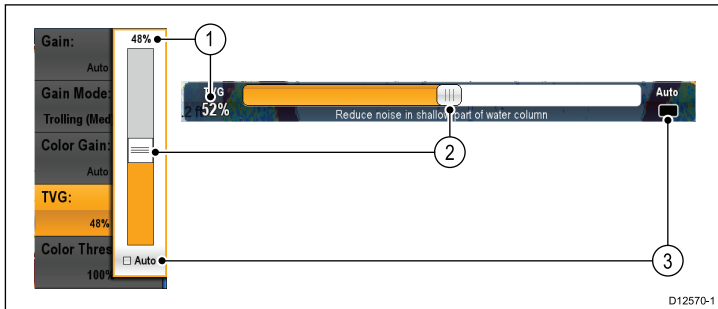

Item	Description	Non—Touch operation	Touch operation
1	Current value	N/A	N/A
2	Slider control	Use the Rotary control to adjust value	Slide the slider Up or Down to adjust value.
3	Auto	Press Ok button to switch between Auto and manual adjustment.	Select to switch between Auto and manual adjustment.

6.17 Editing information in dialogs

With the dialog displayed:

1. Select the field you want to edit.

The on-screen keyboard is displayed:



2. Use the on-screen keyboard to make the changes.
3. Use the on-screen keyboard's **SAVE** key to keep any changes.

Entering special or accented characters

With the on-screen keyboard displayed:

1. Select the on-screen keyboard's **àèò** key.

2. Select the character you want to accent.

The available accented characters are displayed above the text entry field.

3. For characters that have multiple available accents, use the character key to toggle between them.

4. Select the **àèò** key to enter the character.

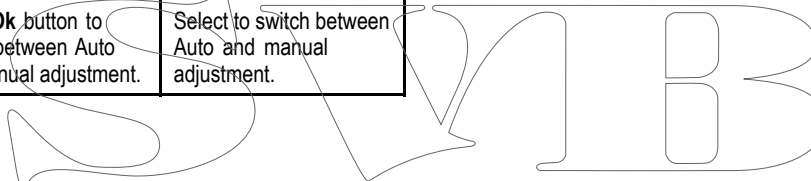

6.18 Editing numerical settings

To edit numerical values in you can either use the **Rotary Control**, the on-screen numeric adjust control or on-screen numeric keypad to increase or decrease the value.

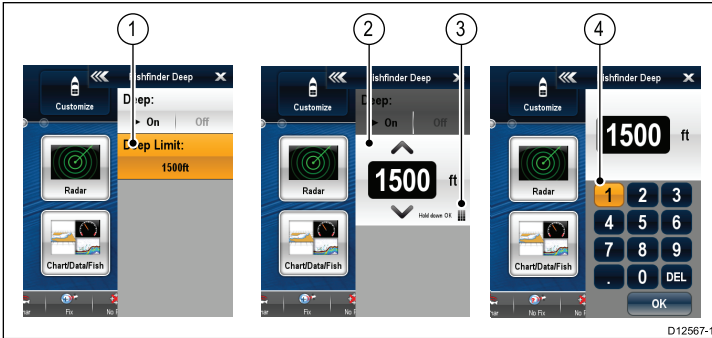

1. Select the numeric data field you want to edit.
The numeric adjust control is displayed.
2. Adjust the setting to the required value using:
 - i. The **Rotary control** — New c Series and New e Series, or
 - ii. The on-screen **Up and Down** arrows — New a Series and New e Series.
3. To access the on-screen numeric keypad:
 - New a Series — Select the on-screen keypad icon from the numeric adjust control.
 - New c Series — Press and hold the **Ok** button.
 - New e Series — Select the on-screen keypad icon from the numeric adjust control.

The on-screen numeric keypad is displayed.

4. Enter the required value.
5. Select **Ok** to exit the numeric keypad and return to the menu.

S.V.B.

6.19 Basic touchscreen operations



Placing and moving the cursor using touch

To place or move the cursor around the screen on a touchscreen multifunction display follow the steps below.

1. Touch the screen at any position on the screen to place the cursor there.

Touchscreen lock



You can lock the touchscreen to prevent accidental use.



This only applies to HybridTouch displays.

For example, locking the touchscreen is particularly useful in rough water or weather conditions.

The touchscreen is locked from the home screen. An icon in the home screen indicates the lock status:

	Touchscreen is unlocked.
	Touchscreen is locked. All functions remain available using the buttons and softkeys.

You must use the UniControl to unlock the touchscreen.

Locking the touchscreen



This only applies to HybridTouch displays.

With the homescreen displayed:

1. Select the **Touch Lock** icon.
It changes color to indicate that the touchscreen is disabled. All functions are still available using the buttons and UniControl.

Unlocking the touchscreen



This only applies to HybridTouch displays.

With the homescreen displayed:

1. Use the UniControl to highlight the **Touch Lock** icon.
2. Press the **OK** button.
The Touchscreen is enabled.

6.20 Databar status symbols





The status symbols on the databar confirm whether the appropriate connections to your system have been made.

The symbols show the status for the following:

- Radar scanner.
- AIS receiver / transceiver.
- Sonar module.
- GPS receiver.
- Autopilot.





Radar scanner status symbols

The radar scanner power mode status is indicated in the databar.

Symbol	Radar power mode	Description
	Transmit (TX)	Rotating icon, signifying that the scanner is on and transmitting. When SCANNER is set to ON, select this mode to activate the scanner. This is the usual mode of operation.
	Standby (STBY)	Static icon, indicating that the scanner is on but not transmitting, and the antenna is not rotating. The scanner does not transmit and the radar data is removed from the screen. This is a power-save mode used when the radar is not needed for short time periods. When you return to transmit mode, the magnetron does not need to warm up again. This is the default mode.
	Off	Scanner powered off when radar not required, but display is in use for other applications, such as the chart. When selected, the system counts down. During this time you cannot re-power the scanner.
 	Timed Transmit	Scanner switches between on/transmitting, and standby mode. Scanner goes into power save mode when constant use of radar is not required.

AIS status symbols

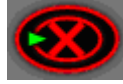

AIS status is indicated by a symbol in the databar.

Symbol	Description
	AIS unit is switched on and operating.
	AIS currently unavailable.
	AIS unit is switched off, or not connected.
	AIS unit is in Silent Mode.
	AIS unit is in Silent Mode, with active alarms.

Symbol	Description
	AIS unit is connected and switched on, but has active alarms.
	AIS unit is connected and switched on, but the dangerous and lost alarm is disabled.



Sonar status symbols

The sonar status is indicated in the databar.

Symbol	Description
	Symbol animated: the sonar module is connected and transmitting.
	Symbol static: the sonar module is connected but not transmitting.
	Symbol greyed-out: the sonar module is not connected, or is not detected.









GPS status symbols

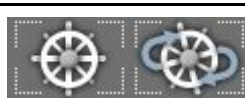

The GPS receiver status is indicated in the databar.

Symbol	Description
	A GPS receiver is connected and has obtained a fix.
	A GPS receiver is not connected, or cannot obtain a fix.

Autopilot status symbols

The autopilot status is indicated in the databar.

Symbol	Description
	Autopilot is in Standby mode.
	Autopilot is in Track mode.
	Autopilot is in Auto mode.
	No autopilot detected.
	Autopilot alarm active.
	Dodge mode is active.
	Fish mode is active.
	Autopilot calibration.

Symbol	Description
	Power steering active.
	Wind Vane mode is active.

6.21 Initial set up procedures

Once your display has been installed and commissioned, Raymarine recommends that you perform an initial set up procedure.

Startup wizard

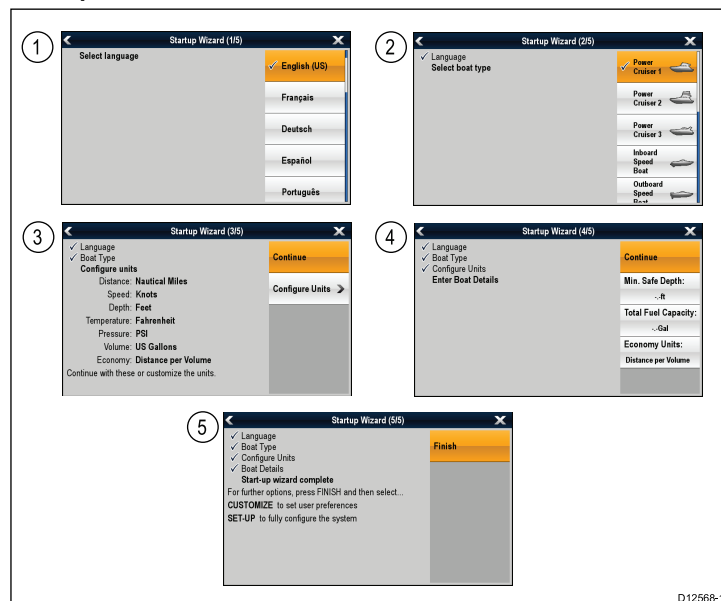

When you power-up the display for the first time or after a system reset a Startup Wizard is displayed. The wizard guides you through the following initial settings:

1. Language selection
2. Vessel type selection
3. Configure units
4. Boat details (minimum safe depth, total fuel capacity and economy units.)
5. Finish

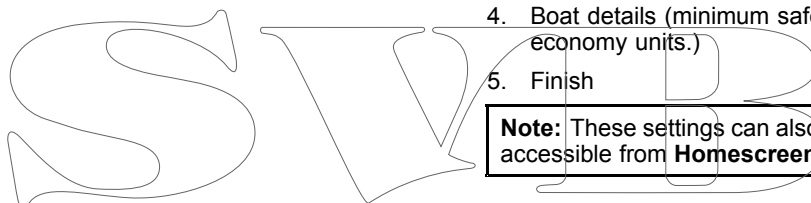

Note: These settings can also be set at any time using the menus accessible from **Homescreen > Customize**.

Additional settings

In addition to the settings covered by the Wizard, it is also recommended that the following initial set up tasks are completed:

- Set your date and time preferences.
- Adjust the display brightness (and set up a shared brightness scheme if appropriate).
- Align the touchscreen (HybridTouch displays only).
- Designate the data master.
- Select the GPS data source.
- Familiarize yourself with the Simulator Mode.

Setting the vessel minimum safe depth

With the homescreen displayed:

1. Select **Customize**.
2. Select **Boat Details**.
3. Select **Min. Safe Depth**.
4. Adjust the setting as appropriate.

Note: The units for the depth measurement are based on those specified in the **Homescreen > Customize > Units Set-up > Depth Units** menu.

Setting time and date preferences

With the homescreen displayed:

1. Select **Customize**.
2. Select **Time and Date Set-up**.
3. Use the **Date Format**, **Time Format**, and **Local Time: UTC** menu items to set your time and date preferences.

Adjusting the display brightness — New a Series and New e Series

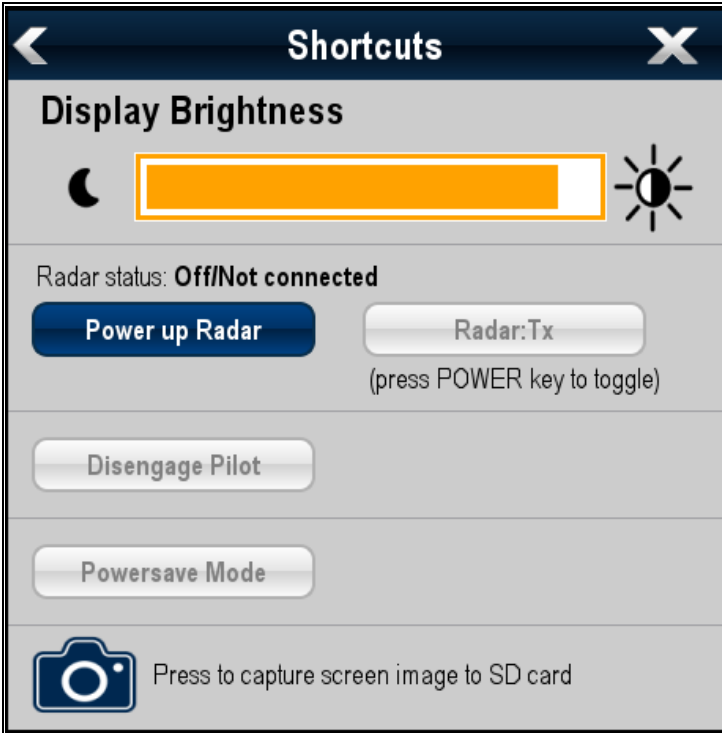

1. Press the **POWER** button once.
The Shortcuts menu is displayed.
2. Adjust the brightness to the required level using the on-screen brightness slider bar control, or
3. Touch the Sun icon to increase the brightness level or the Moon icon to decrease the brightness level.

Note: The brightness level can also be increased by pressing the **Power** button multiple times.

Adjusting the display brightness

1. Press the **POWER** button once.
The Shortcuts menu is displayed.
2. Adjust the brightness to the required level using the **Rotary control**.

Note: The brightness level can also be increased by pressing the **Power** button multiple times.

Touchscreen alignment

If the touchscreen is misaligned to your touch, you can realign it to improve the accuracy.

Realignment involves a simple exercise to align an on-screen object with your touch. For best results, perform this exercise when your vessel is anchored or moored.

Note: This only applies to touchscreen multifunction displays.

Aligning the touchscreen

With the homescreen displayed:

1. Select **Set-up**.
2. Select **Maintenance**.
3. Select **Touchscreen Alignment**.
4. Place your finger over the on-screen object momentarily, then remove it.
5. Repeat the action a further 3 times.
6. If the operation was successful, an "Alignment Completed" message is displayed.
7. Select **Exit** to return to the Maintenance menu.
8. If the operation was unsuccessful at any point during the alignment exercise, an "Incorrect touch detected" message is displayed, the alignment exercise is repeated.

9. After 2 failed alignment exercises you may be asked to perform a precision alignment exercise.

Data master

Any system containing more than one networked multifunction display must have a designated data master.

The data master is the display which serves as a primary source of data for all displays, it also handles all external sources of information. For example the displays may require heading information from the autopilot and GPS systems, usually received through a SeaTalk^{ng} or NMEA connection. The data master is the display to which the SeaTalk, NMEA and any other data connections are made, it then bridges the data to the SeaTalk^{hs} network and any compatible repeat displays. Information shared by the data master includes:

- Cartography
- Routes and waypoints
- Radar
- Sonar
- Data received from the autopilot, instruments, the engine and other external sources.

Your system may be wired for redundancy with data connections made to repeat displays. However these connections will only become active in the event of a fault and/or reassignment of the data master.

Designating the data master

For systems with 2 or more displays the following task must be performed on the multifunction display that you want to designate as the data master.

With the homescreen displayed:

1. Select **Set-up**.
2. Select **Maintenance**.
3. Select **Data Master**.
4. Select the display that you want to designate as the data master.

GPS selection

You can use an internal (if available) or external GPS receiver.

- Your multifunction display may feature an internal GPS receiver.
- You can also connect an external GPS receiver using SeaTalk^{ng} or NMEA 0183.
- Where appropriate use the System Settings menu to enable or disable the internal GPS receiver.

Enabling or disabling the internal GPS

If your multifunction display features an internal GPS then this can be enabled and disabled by following the steps below.

With the homescreen displayed:

1. Select **Set-Up**.
2. Select **System Settings**.
3. To enable the internal GPS, select **Internal GPS** so that On is highlighted.
4. To disable the internal GPS, select **Internal GPS** so that Off is highlighted.

Simulator mode

The Simulator mode enables you to practice operating your display without data from a GPS antenna, radar scanner, AIS unit, or fishfinder.

The simulator mode is switched on / off in the **System Setup Menu**.

Note: Raymarine recommends that you do NOT use the simulator mode whilst navigating.

Note: The simulator will NOT display any real data, including any safety messages (such as those received from AIS units).

Note: Any system settings made whilst in Simulator mode are NOT transmitted to other equipment.

Enabling and disabling simulator mode

You can enable and disable simulator mode by following the steps below.

With the homescreen displayed:

1. Select **Set-Up** .
2. Select **System Settings**.
3. Select **Simulator**.
4. Select On to turn simulator mode on, or
5. Select Off to turn simulator mode off.

Note: The Demo movie option is for retail demonstration purposes only.

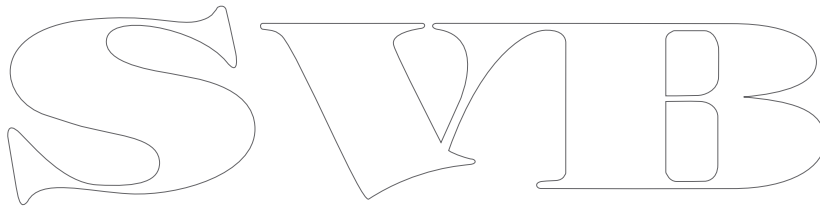
A large, stylized outline logo consisting of the letters 'S', 'W', 'I', and 'B' in a decorative, serif font. The letters are hollow and have a classic, elegant appearance.

SWIB

Chapter 7: Managing display data

Chapter contents

- [7.1 Memory cards overview on page 88](#)
- [7.2 Inserting a memory card or chart card on page 88](#)
- [7.3 Removing a memory card or chart card on page 89](#)
- [7.4 Saving user data and user settings on page 89](#)
- [7.5 Screenshots on page 92](#)
- [7.6 Resetting your system on page 92](#)

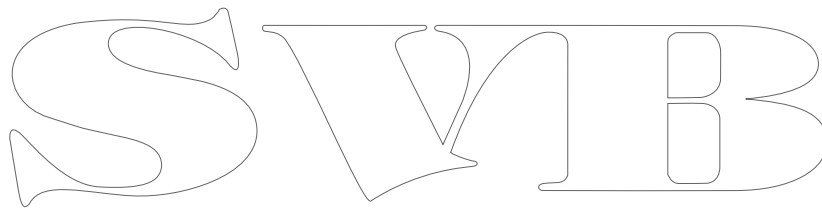

7.1 Memory cards overview

You can use memory cards to archive data such as waypoints, routes, and tracks.

Memory cards can be used to archive your data when the system capacity is reached. You can then delete old data from your system, creating capacity for new data. The archived data can be retrieved at any time. You can also use memory cards to backup your data.

Note: Raymarine recommends that you backup your data to a memory card on a regular basis.

7.2 Inserting a memory card or chart card

Note: New a Series displays have 1 card slot, cards must be inserted into New a Series displays with the contacts facing up.

1. Open the chart card door, located on the front right of the display.
2. Insert the card, as shown in the diagram below. For slot 1, the card contacts should be facing DOWN. For slot 2, the card contacts should be facing UP. Do NOT force the card. If the card does not fit easily into the slot, check the orientation.

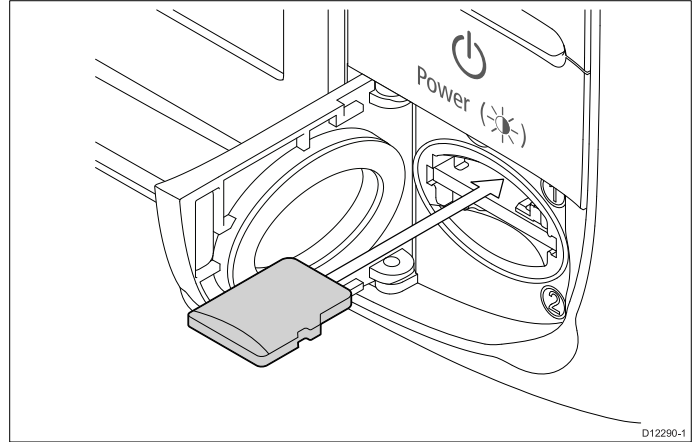

3. Gently press the card all the way in to the card slot, as shown in the diagram below. The card is secure when an audible click is heard.

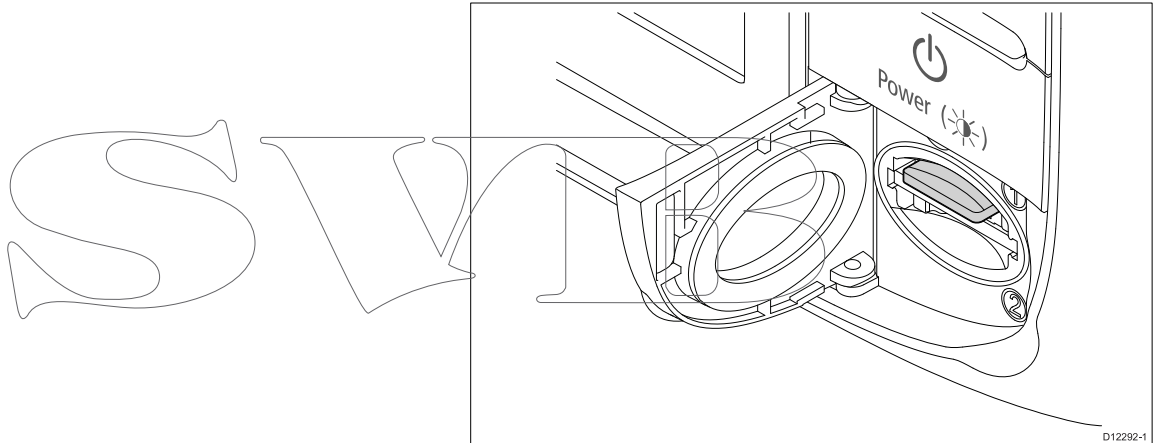

4. To prevent the ingress of water and consequent damage, close the chart card door.

7.3 Removing a memory card or chart card

From the homescreen:

1. Select **My Data**.
2. Select **Eject Card**.
A message is displayed prompting you to select the memory device you want to eject.
3. Select **SD1** for a memory card in the top card slot, or **SD2** for a memory card in the bottom card slot.
4. Open the chart card door, located on the front right of the display.
5. Push the edge of the card towards the unit, until an audible click is heard.
The card is released from the card slot mechanism, as shown in the following diagram:

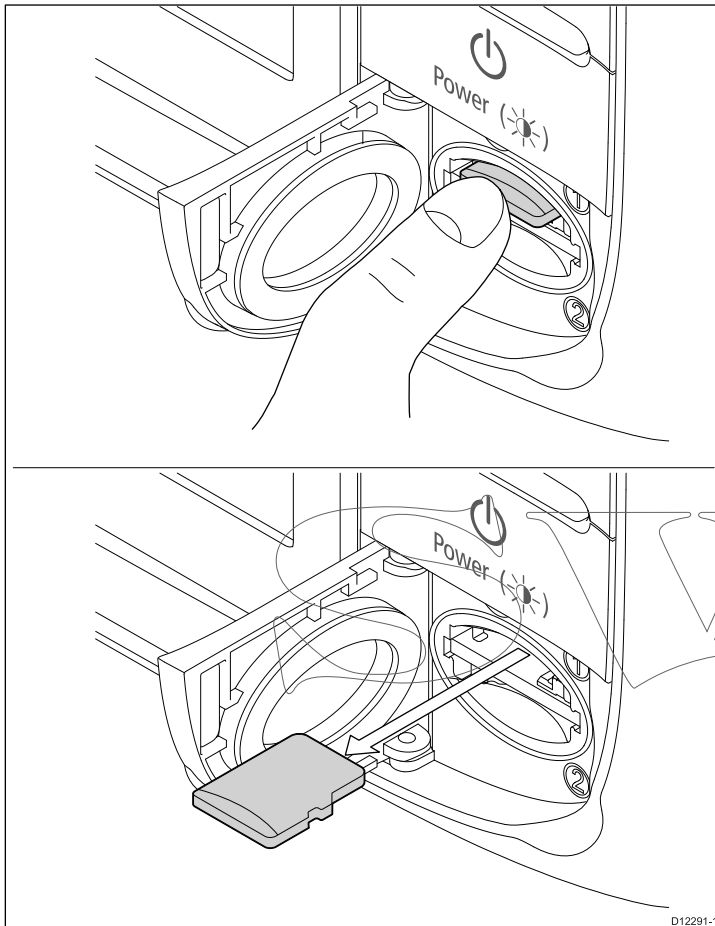

6. Use your fingers to pull the card clear of the card slot, using the edge of the card.
7. To prevent the ingress of water and consequent damage, close the chart card door.

Note: You can also power off the multifunction display and follow steps 4 to 7 above.

7.4 Saving user data and user settings

You can save user data (waypoints, routes, and tracks) or user settings to a memory card for later retrieval.

Type of data	Description	Notes
User data (waypoints)	Saves all waypoints to a single archive file.	Only 1 waypoints archive file can be saved per memory card.
User data (routes)	Saves all routes to a single archive file.	Only 1 routes archive file can be saved per memory card.
User data (tracks)	Saves all tracks to a single archive file.	Only 1 tracks archive file can be saved per memory card.
User settings	Saves the settings you've made in the set-up menus to a single archive file.	Only 1 user settings archive file can be saved per memory card.

Note: Raymarine recommends that you save your user data and user settings to a memory card on a regular basis.

Note: Raymarine strongly recommends that you save settings to a separate memory card, and NOT to a chart card containing cartography.

Saving waypoints, routes, and tracks to a memory card

With the homescreen displayed:

1. Ensure you have a memory card (NOT a chart card) in one of the card slots.
2. Select **My Data**.
3. Select **Save Data to Card**.
If your display has more than 1 card slot then a message is displayed prompting you to select the memory device you want to save the data to, if your display only has 1 card slot then you will not be prompted.
4. Select **SD1** for a memory card in the top card slot, or **SD2** for a memory card in the bottom card slot.
5. Select **Save Waypoints to Card**, **Save Routes to Card**, or **Save Tracks to Card**, as appropriate.

Retrieving waypoints, routes, or tracks from a memory card

With the homescreen displayed:

1. Ensure you have a memory card containing the user data in one of the card slots.
2. Select **My Data**.
3. Select **Retrieve from Card**.
If your display has more than 1 card slot then a message is displayed prompting you to select the memory device you want to retrieve data from, if your display only has 1 card slot then you will not be prompted.
4. Select **SD1** for a memory card in the top card slot, or **SD2** for a memory card in the bottom card slot.
5. Select **Retrieve Waypoints**, **Retrieve Routes**, or **Retrieve Tracks**, as appropriate.

Erasing waypoints, routes, and tracks from a memory card

With the homescreen displayed:

1. Ensure you have the memory card containing the data in one of the card slots.
2. Select **My Data**.
3. Select **Erase from Card**.
If your display has more than 1 card slot then a message is displayed prompting you to select the memory device you want to erase data from, if your display only has 1 card slot then you will not be prompted.

4. Select **SD1** for a memory card in the top card slot, or **SD2** for a memory card in the bottom card slot.
5. Select **Erase Waypoints from Card**, **Erase Routes from Card**, or **Erase Tracks from Card**, as appropriate.

Erasing waypoints, routes, and tracks from the system

Note: The following procedure permanently erases selected or ALL waypoints, routes, or tracks stored on the display. BEFORE proceeding, ensure that you backup any data that you want to keep on to a memory card.

With the homescreen displayed:

1. Select **My Data**.
2. Select **Erase from System**.
3. Select **Erase Waypoints from System**, **Erase Routes from System**, or **Erase Tracks from System**, as appropriate.
4. Select the specific data items you want to erase, or select **Erase All**.

A message is displayed prompting you for confirmation.

5. Select **Yes** to proceed with the deletion, or **No** to cancel the operation.

Saving user settings to a memory card

With the homescreen displayed:

1. Ensure you have a memory card (NOT a chart card) in one of the card slots.
2. Select **My Data**.
3. Select **Backup and Restore Settings**.
4. Select **Backup Settings**.

If your display has more than 1 card slot then a message is displayed prompting you to select the memory device you want to save the settings to, if your display only has 1 card slot then you will not be prompted.

5. Select **SD1** for a memory card in the top card slot, or **SD2** for a memory card in the bottom card slot.

Retrieving user settings from a memory card

With the homescreen displayed:

1. Ensure you have the memory card containing the user data in one of the card slots.
2. Select **My Data**.
3. Select **Backup and Restore Settings**.
4. Select **Restore Settings**.
If your display has more than 1 card slot then a message is displayed prompting you to select the memory device you want to retrieve settings from, if your display only has 1 card slot then you will not be prompted.
5. Select **SD1** for a memory card in the top card slot, or **SD2** for a memory card in the bottom card slot.

Save and retrieve items

The table below details the data items and settings which will be saved to and retrieved from SD card on your multifunction display.

Homescreen and system settings

Application	Setting
Homescreen	Default page configuration
System settings	Position mode
	Text size
	Shared brightness
	Brightness group
	TD set-up
	Simulator
	Bearing mode

Application	Setting
	MOB Data type
	Variation source
	Manual variation
	Language
	Date format
	Time format
	Local time offset
	Distance units
	Distance subunits
	Speed units
	Depth units
	Temperature units
	Pressure units
Volume units	
System settings — integration	Autopilot control
	DSC message
	SeaTalk alarms
	Bridge NMEA heading
Multiple data sources	GPS position source
	Heading source
	Depth source
	Speed source
	Wind source
Databar set-up	Databar content (cell 1 to 6)
	Compassbar
	Status icon
GPS status	GPS screen

Alarms

Application	Setting
Alarms	Anchor alarm
	Timer
	Alarm clock
	Temperature alarm
	Arrival alarm
	Offtrack alarm
	Collision alarm
	Guard zone sensitivity
	Fish alarm
	Fish alarm depth limit
	Shallow depth alarm
	Deep depth alarm
	AIS dangerous target alarm

Chart application — Cartography settings

Application	Setting
Cartography	Data overlay cell 1 on / off
	Data overlay cell 1 content

Application	Setting
	Data overlay cell 2 on / off
	Data overlay cell 2 content
	Chart object menu
	Chart display
	Chart grid
	2D shading
	Community layer
	Chart text
	Chart boundaries
	Spot soundings
	Safety contour
	Depth contour
	Deep water color
	Hide rocks
	Nav marks
	Nav marks symbols
	Light sectors
	Routing systems
	Caution areas
	Marine features
	Land features
	Business services
	Panoramic photos
	Roads
	Additional wrecks
	Aerial photo overlay
	colored seabed areas
	Vessel icon
	Vessel size

Data application

Application	Setting
Data	Datapages and content
	Datapage order
	Color theme
	Dial color
	Number of engines
	Maximum tachometer range

Fishfinder application

Application	Setting
Fishfinder	Configure preset frequencies

Weather application

Application	Setting
	Wind symbol
	Watchbox alerts

Boat details

Application	Setting
	Economy units
	Low fuel threshold
	Fuel alarm on/off

Radar application

Application	Setting
Radar	Select scanner
	Range rings

AIS Layer

Application	Setting
AIS Layer	Displayed target types
	AIS safety messages
	Buddy tracking
	Silent mode

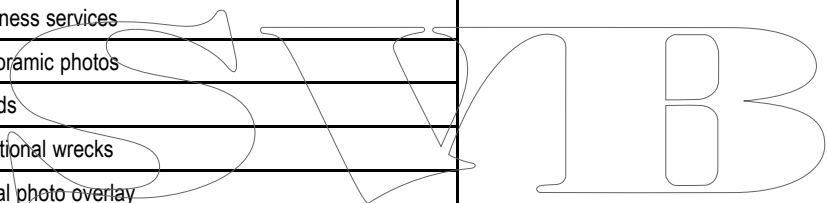

7.5 Screenshots

You can take a screenshot of what is currently displayed on the screen.

Screenshots are saved to an SD card in .bmp (bitmap) format. The saved image can be viewed from the multifunction display or any device capable of viewing bitmap images.

Taking a screenshot

You can take a screenshot by following the steps below.

1. Insert an SD card with suitable free space available into the SD card slot of your multifunction display.

Note: The SD card slot should be inserted into the card slot selected in the **Customize > Display Preferences > Screenshot File** menu option accessible from the homescreen.

2. Press the **Power** button.
The Shortcuts page is displayed:



3. Select the **Camera** icon.
A confirmation pop-up is displayed.
4. Select **Ok**.
The screenshot is now saved to the SD card.

Selecting the SD card slot for screenshots

New c Series and New e Series multifunction displays have 2 SD card slots. When performing a screenshot you must first select which card slot to save the screenshot too.

From the homescreen.

1. Select **Customize**.
2. Select **Display Preferences**.
3. Select **Screenshot File**.
4. Select either **MicroSD 1** or **MicroSD 2**.

Viewing a screenshot on the multifunction display

You can view images on the multifunction display

1. Insert an SD card with the screenshot or image saved to it, into the SD card slot of your multifunction display.
2. From the homescreen, select **My Data**.
3. Select **View Images**.
The file browser dialog is displayed.
4. Browse to the location on the SD card to where the image is saved.
5. Select the image you want to view.
The image will now open.
6. Select **Back** or **Close** to close the image.

7.6 Resetting your system

Your system may be reset to its factory default settings if required.

There are 2 types of reset operation, both of which affect the current display you are using, AND any networked displays.

- Settings reset.
- Settings and data reset.

Settings reset

This option resets your setup menus, page sets, and databar settings to factory default. It will NOT affect your waypoints, routes, or tracks data.

Settings and data reset

In addition to the settings reset detailed above, performing a settings and data reset will also remove ALL waypoints, routes, and tracks data.

Resetting system settings

With the homescreen displayed:

1. Select **Set-up**.
2. Select **Maintenance**.
3. Select **System Settings Reset**.
A message is displayed prompting you to confirm the action.
4. Select **Yes** to proceed with the settings reset, or **No** to cancel.

Resetting system settings and data

Note: Performing a settings and data reset erases ALL waypoints, routes, and track data from your system. BEFORE proceeding with a settings and data reset, ensure that you backup any data that you want to keep on to a memory card.

With the homescreen displayed:

1. Select **Set-up**.
2. Select **Maintenance**.
3. Select **System Settings and Data Reset**.
A message is displayed prompting you to confirm the action.
4. Select **Yes** to proceed with the settings and data reset, or **No** to cancel.

Chapter 8: Using the document viewer

Chapter contents

- [8.1 Document viewer overview on page 94](#)

SWIB

8.1 Document viewer overview

Your multifunction display includes a pdf document viewer.

The document viewer is available from the homescreen and is used to view and search pdf documents (such as product handbooks).

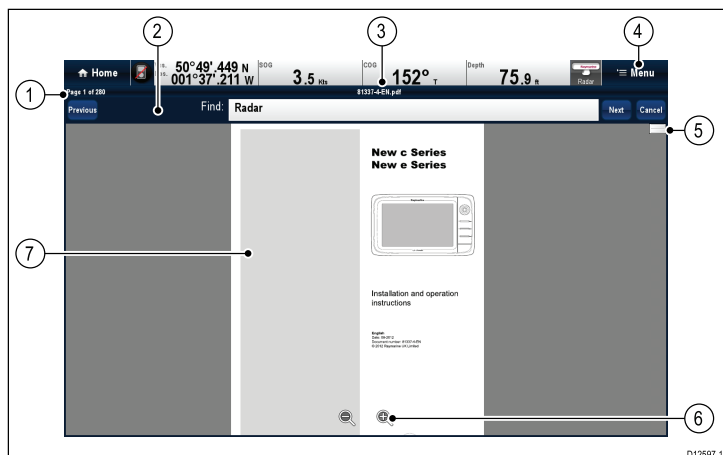

1	Current page number (page x of y)
2	Find (search) tool bar (only displayed when searching a document.)
3	Current pdf's filename
4	Document viewer menu
5	Scroll bar
6	On-screen zoom controls (Touchscreen displays only)
7	pdf document content

Note: The document viewer does not support password protected documents or documents containing security certificates. An error message will be displayed if you try to open such documents.

The following options are available from the document viewer menu:

- **Open File** — Allows you to browse for a pdf document to open.
- **Find** — Allows you to search the document for a specified words.
- **Go to page:** — Allows you to jump to a specified page number.

Opening a pdf document

You can open pdf documents stored on an SD card by following the steps below.

Note: When saving pdf documents to SD cards, ensure you do not overwrite important data.



1. Save the required pdf document to SD card.
2. Insert the SD card into the SD card slot of the multifunction display you wish to view the document on.
3. Select **Menu**.
4. Select **Open File**.
The file browser dialog is displayed.
5. Browse to the location on the SD card where you saved the document to.
6. Select the document you want to view.
The document will now open.
7. If the 'Cannot Open File' error message is displayed then select **Ok** to confirm and then try opening the document again or check that the pdf is not corrupted or whether it contains security which is not supported by the document viewer application.

Note: Large filesize pdf documents may take a while to open.

Browsing an open document

On touchscreen displays you can browse pdf documents as detailed below.

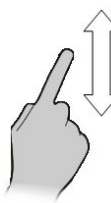
With a pdf document open:

	<ul style="list-style-type: none"> • Move your finger up to scroll down the document. • Move your finger down to scroll up the document.
	When the document width is greater than the width of the application window, move your finger left or right to pan the width of the document.

Note: You can also use the scroll bars to navigate through the document.

Browsing an open document

On HybridTouch and non-touch displays you can browse pdf documents by following the steps below.

With a pdf document open:

1. Move the Joystick **Up** or **Down** to move up and down through the document.
2. Move the Joystick **Left** or **Right** to pan left and right.

Changing the zoom factor

On touchscreen displays you can change the zoom factor of the open document by following the steps below.

With a pdf document open:

1. Select the on-screen **Zoom in** icon to zoom in, or
2. Select the on-screen **Zoom out** icon to zoom out.

Changing the zoom factor

On HybridTouch and non-touch displays (excluding the e7 and e7D) you can change the zoom factor of the open document by following the steps below.

With a pdf document open:

1. Use the **Range out** button to zoom out, or
2. Use the **Range in** button to zoom in.

Note: New a Series and e7 / e7D multifunction displays do not have Range in and Range out button.

Selecting a page

You can skip to the page you want to view by entering the page number.

With a pdf document open:

1. Select **Menu**.
2. Select **Go to page:**.
The numeric keypad is displayed.
3. Enter the page number of the page you want to view.
4. Select **Ok** to view the page.

Using document hyperlinks

On touchscreen displays you can use internal document hyperlinks.

With a pdf document opened on a page containing a hyperlink:

1. Momentarily touch your finger on the hyperlink.
You will be taken to the hyperlinked page.

Note: Document hyperlinks cannot be activated on a New c Series display.



Searching for text

On touchscreen displays you can use the find function to search for text in an open pdf document.

With a pdf document open:

1. Select **Menu**.
2. Select **Find**.
The on-screen keyboard is displayed.
3. Enter the keyword you want to find.
4. Select **SAVE**.
The document viewer will enter find mode and:
 - You may see a 'Searching' icon while all occurrences are found.
 - The find tool bar is displayed.
 - The first occurrence of the keyword is highlighted.
5. Select **Next** to find the next occurrence of the keyword, or
6. Select **Previous** to go back to the last occurrence of the keyword.
7. You can select **Cancel** at any time to close the find tool bar and return to the normal viewing.



Searching for text

On HybridTouch and non-touch displays you can use the find function to search for text in an open pdf document by following the steps below.

With a pdf document open:

1. Press the **Menu** button.
2. Select **Find**.
The on-screen keyboard is displayed.
3. Enter the keyword you want to find.
4. Select **SAVE**.
The document viewer will enter find mode and:
 - You may see a 'Searching' icon while all occurrences are found.
 - The find tool bar is displayed.
 - The first occurrence of the keyword is highlighted.
5. Move the **Joystick Down** to go to the next occurrence of the keyword, or
6. Move the **Joystick Up** to go to the previous occurrence of the keyword.
7. You can press the **Back** button at any time to close the find tool bar and return to the normal viewing.

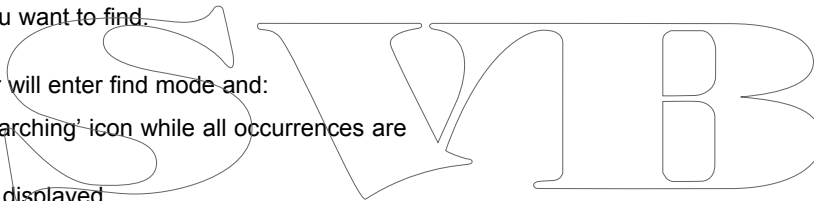

Keyword not found

The document viewer will let you know if the keyword you have searched for does not appear in the document.

If the keyword is not found then the find tool bar will display an exclamation mark and a pop-up message is displayed on-screen.

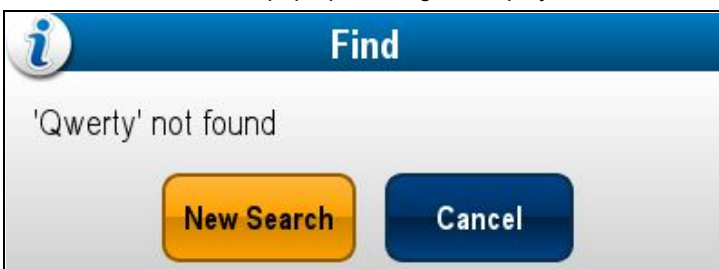

Selecting **New Search** will take you back to the on-screen keyboard so that you can try a different keyword. Selecting **Cancel** will close the find tool bar and resume normal operation.

SWIB

Chapter 9: Using autopilot control

Chapter contents

- [9.1 Autopilot control on page 98](#)
- [9.2 Autopilot status symbols on page 99](#)
- [9.3 Autopilot alarms on page 100](#)

SWIB

9.1 Autopilot control

You can use your multifunction display to control your autopilot.

Note: For information on connecting your multifunction display to a Raymarine autopilot system, refer to the documentation that accompanied your autopilot.

With the Autopilot Control function enabled, you can use your multifunction display to:

- Engage the autopilot and instruct it to follow a route, or a waypoint.
- Disengage the autopilot.
- Silence the waypoint arrival alarm.

Pilot Control dialog

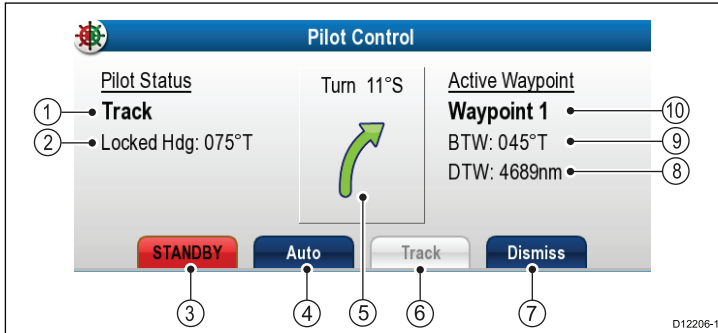

Item	Description
1	Pilot Mode.
2	Current Locked Heading.
3	STANDBY — Disengages the autopilot and return to manual vessel control.
4	Auto —Engages the autopilot.
5	Turn angle — The turn angle is only available for SPX autopilots connected using SeaTalk ^{ng} . This indicates the direction and severity of turns to be made under autopilot.
6	Track — Engages the autopilot in Track mode and automatically steers your vessel along a route plotted on your chartplotter.
7	Dismiss — Dismisses the Pilot Control dialog.
8	Distance to next waypoint.
9	Bearing to next waypoint.
10	Next waypoint name.

Note: The **Pilot Control** dialog will close if no action is taken for 10 seconds.

The Pilot Control dialog is displayed in the following situations:

- When you select **Menu > Navigate > Goto Waypoint**, **Goto Cursor** or **Follow Route** option in the chart application.
- When you select **Goto Waypoint** or **Goto Cursor** using the chart context menu.
- When you place the cursor over an active route or waypoint on the chart and select **Stop Goto**, **Stop Follow** or **Advance Waypoint** from the context menu.
- When you are following a route or going to a waypoint or cursor position, and select **Menu > Navigate > Stop Goto**, **Stop Follow**, or **Advance Waypoint**.
- When you arrive at a target waypoint.

Note:

When arriving at a waypoint, the dialog title bar turns red to indicate waypoint arrival.

Enabling the autopilot control function

From the homescreen:

1. Select **Set-up**.
2. Select **System Settings**.

3. Select **Autopilot Control** so that On is highlighted.

Selecting Autopilot Control will switch the control between On and Off.

Disengaging the autopilot using the shortcuts menu

On multifunction displays which do not have a dedicated pilot button (i.e. a65, a67, e7 and e7D) you can disengage the autopilot from the Shortcuts menu.

With the autopilot engaged:

1. Press and release the **POWER** button.
2. Select **Disengage Pilot**.

The autopilot is disengaged, and put into standby mode.

Disengaging the autopilot using the pilot button

On multifunction displays which have a dedicated pilot button (i.e. New c Series and New e Series displays, excluding the e7 and e7D) you can disengage the autopilot using the dedicated Pilot button.

With the autopilot engaged:

1. Press the **Pilot** button.

The autopilot is disengaged, and put into standby mode.

Disengaging the autopilot from the chart application

On all multifunction display variants the autopilot can be disengaged from the chart application's menu.

In the chart application with the autopilot engaged:

1. Select **Menu > Navigate > Stop Goto** or **Stop Follow**.
The Pilot Control dialog is displayed.
2. Select **STANDBY**.

The autopilot is disengaged, and put in standby mode.

Engaging the autopilot using the shortcuts menu

On multifunction displays which do not have a dedicated pilot button (i.e. a65, a67, e7 and e7D) you can engage the autopilot from the Shortcuts menu.

With the autopilot disengaged:

1. Press and release the **POWER** button.
2. Select **Engage Pilot**.

The autopilot is engaged.

Engaging the autopilot using the pilot button

On multifunction displays which have a dedicated pilot button (i.e. New c Series and New e Series displays, excluding the e7 and e7D) you can engage the autopilot using the dedicated Pilot button.

With the autopilot disengaged:

1. Press the **Pilot** button.
The pilot control dialog is displayed.
2. Select **Engage Pilot**.

Note: You can also automatically engage the autopilot by pressing and holding the **Pilot** button.

Engaging the autopilot from the chart application menu

In the chart application:

1. Select **Menu > Navigate > Goto Cursor**, **Goto Waypoint**, or **Follow Route** as appropriate.
The Pilot Control dialog is displayed.
2. Select **Engage Pilot**.
A confirmation pop-up message is displayed.
3. Select **Yes** to confirm and engage the autopilot, or
4. Select **No** to leave the autopilot in the current state.

Engaging the autopilot using the context menu

From the chart application context menu::

1. Select any of the following options from the Chart context menu:
 - **Goto Waypoint**
 - **Goto Cursor**
 - **Follow Route**
 - **Follow from Here**
 - **Follow Route in Reverse**

The pilot control dialog is displayed.

2. Select **Yes (Track)**.
A confirmation pop-up message is displayed.
3. Select **Yes** to confirm and engage the autopilot.

Manually displaying the pilot control dialog box

You can also open the Pilot Control dialog at any time from the homescreen or chart application.

1. From the homescreen:
 - i. Select **Set-up**.
 - ii. Select **Pilot Controls**.
2. From the chart application:
 - i. Select **Menu**.
 - ii. Select **Navigate**.
 - iii. Select **Pilots Controls**.

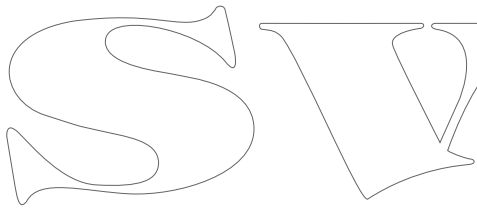

9.2 Autopilot status symbols

The autopilot status is indicated in the databar.

Symbol	Description
	Autopilot is in Standby mode.
	Autopilot is in Track mode.
	Autopilot is in Auto mode.
	No autopilot detected.
	Autopilot alarm active.
	Dodge mode is active.
	Fish mode is active.
	Autopilot calibration.
	Power steering active.
	Wind Vane mode is active.

9.3 Autopilot alarms

The autopilot function provides alarms to alert you to situations that require action.

Your multifunction display shows autopilot alarms, regardless of whether there is active navigation on the system. If autopilot control is enabled, and an alarm is raised by the autopilot, the multifunction display provides an audible alarm sound (providing that the alarm has not already been silenced). The **Pilot Control** dialog is displayed, indicating a new alarm. Additionally, the autopilot status icon is displayed in red, and remains red until the alarm is cleared.

Silencing autopilot alarms

1. Select **Dismiss**.

The alarm is silenced and the autopilot remains engaged in auto mode, continuing on the current locked heading.

2. Select **Auto**.

The alarm is silenced and the autopilot remains engaged in auto mode, continuing on the current locked heading.

3. Select **Track**.

The alarm is silenced and the autopilot 'tracks' to the next waypoint.

Silencing autopilot alarms and disengaging autopilot

1. Select **STANDBY**.

The alarm is silenced, and the autopilot is disengaged and put in standby mode.

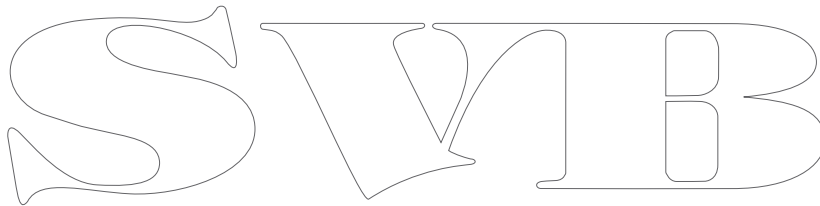
A large, stylized outline graphic of the word "STANDBY" in a serif font. The letters are hollow and have a decorative, slightly calligraphic appearance.

Chapter 10: Using alarms and MOB functions

Chapter contents

- [10.1 Using Man Overboard \(MOB\) functions on page 102](#)
- [10.2 Alarms on page 103](#)

SWIB

10.1 Using Man Overboard (MOB) functions

Man overboard

If you lose a person or object overboard, you can use the Man Overboard (MOB) function to mark the position that the vessel was at when the MOB function was activated.

The MOB function is available at all times, regardless of which application is running. MOB can be set to Dead Reckoning or Position mode. Dead Reckoning mode will take into consideration the effects of wind and tides. This usually provides a more accurate course. Position mode does not take these factors into account.

To obtain a MOB position, your multifunction display must have a GPS position fix. If you're using dead reckoning, heading and speed data must also be available.

When MOB is **activated**:

- An audible MOB alarm is sounded.
- An MOB alarm dialog box is displayed.
- The system sends MOB alarms to other Raymarine equipment.
- The active chart application is changed to a low-detail 2D view, with an initial range of 15 m (50 ft). Motion mode is set to Auto Range.
- The active radar application range is changed to 230 m (760 ft).
- All Goto and Follow functions are disabled in all applications. Navigation to any active waypoint is stopped and any existing navigation function is cancelled.
- If position or heading and speed information is available a MOB waypoint is placed at the current vessel position in any application that is capable of showing waypoints and vessel position.
- MOB data is displayed in the databar, replacing the existing data.
- MOB data is displayed on the homescreen, replacing the status icons.
- As the vessel moves away from the MOB position a dotted line is displayed, joining the MOB position with the vessel's position.

When the MOB alarm is **cancelled**:

- MOB data is removed from the relevant applications.
- The chart application motion mode is reset.
- The chart is centered on the vessel and pitch / rotation set to default.
- GOTO and route functions are restored.
- The databar mode is reset.
- A MOB normal mode signal is sent to any instrument on SeaTalk.

Activating the man overboard (MOB) alarm — New c Series / New e Series

On a New c Series or New e Series display you can use the WPT (MOB) button to activate the MOB alarm

1. Press and hold the **WPT / MOB** button for 3 seconds.

Activating the man overboard (MOB) alarm — New a Series

On a New a Series display you can use the on-screen WPT (MOB) icon to activate the MOB alarm

1. Press and hold the on-screen **WPT / MOB** icon for 3 seconds.

Silencing the MOB alarm.

The MOB alarm can be silenced by following the steps below.

With a MOB alarm active:

1. Select **Ok** on the MOB alarm dialog.
The alarm will be silenced but remains active.



Cancelling the man overboard (MOB) alarm — New a Series

To cancel a MOB alarm and resume normal operation follow the steps below:

1. Press and hold the on-screen **WPT / MOB** icon for 4 seconds.
The MOB alarm is cancelled and normal operation is resumed.

Cancelling the man overboard (MOB) alarm — New c Series and New e Series

To cancel a MOB alarm and resume normal operation follow the steps below:

1. Press and hold the **WPT / MOB** button for 4 seconds.
The MOB alarm is cancelled and normal operation is resumed.

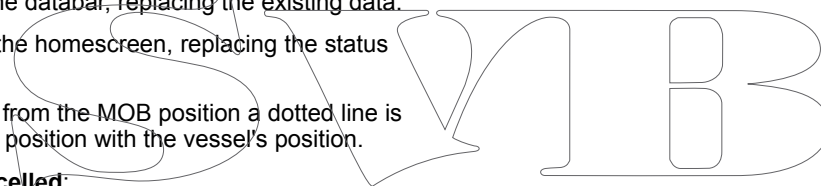

10.2 Alarms

Alarms alert you to a situation or hazard requiring your attention.

You can set up alarms to alert you to certain conditions, such as collision warnings and temperature limits.

Alarms are raised by system functions, and also external equipment connected to your multifunction display.

When an alarm sounds a message dialog is displayed on your multifunction display and any networked displays. The dialog states the reason for the alarm.

You can configure the behavior of certain alarms by selecting the Edit option on the message dialog or by using the **Alarms** menu, accessible from the homescreen via the **Set-Up** icon.

Silencing/Canceling alarms

To silence/cancel an active alarm:

1. Select **Ok** on the alarm message dialog.

Note: Once silenced some alarms may remain active.

A large, stylized outline of the letters 'SWIB' in a decorative, serif font. The letters are hollow and have a classic, elegant appearance.

Alarms menu

Menu item	Description	Options
MOB Data Type	Determines whether Position or Dead Reckoning (DR) data is displayed. Assuming that your vessel and the MOB are subject to the same tide and wind effects, the Dead Reckoning setting normally gives a more accurate course.	<ul style="list-style-type: none"> • Dead Reckoning • Position (default)
Alarm Clock	When set to On, an alarm is triggered at the time you specify for the Alarm Clock Time setting.	<p>Alarm Clock</p> <ul style="list-style-type: none"> • Off (default) • On <p>Alarm Clock Time</p> <ul style="list-style-type: none"> • 00:00 (default) • 00.01 to 24:00 hrs
Anchor Drift	When set to On, the Anchor Drift alarm is triggered when your vessel drifts from your anchor position by more than the distance you specify for the Anchor Drift Range setting.	<p>Anchor Drift</p> <ul style="list-style-type: none"> • Off (default) • On <p>Anchor Drift Range</p> <ul style="list-style-type: none"> • 0.01 — 9.99 nm (or equivalent units)
Countdown Timer	When set to On, counts down the time period you specify for the Timer Period setting, and triggers an alarm when zero is reached.	<p>Countdown Timer</p> <ul style="list-style-type: none"> • Off (default) • On <p>Timer Period</p> <ul style="list-style-type: none"> • 00h00m (default) • 00h01m to 99h59m
AIS Targets	When set to On, the alarm for Dangerous Targets is enabled. This option is only available when an AIS unit is detected. Refer to the AIS section for details.	<p>Dangerous Targets</p> <ul style="list-style-type: none"> • On (default) • Off
Engine Alarms	When set to On then warning alarms from connected engine management systems will be displayed on the multifunction display.	<p>Engine Alarms</p> <ul style="list-style-type: none"> • On (default) • Off
Fishfinder Deep	<p>If this option is set to On, an alarm is triggered when the depth exceeds the value that you specify. This option is only available when a sonar module is detected.</p> <p>Note: The Fishfinder Deep alarm limit cannot be set to a value less than the Shallow Limit.</p>	<p>Fishfinder Deep</p> <ul style="list-style-type: none"> • Off (default) • On <p>Deep Limit</p> <ul style="list-style-type: none"> • 2 ft (or equivalent units) to the maximum of the transducer range
Fishfinder Shallow	<p>If this option is set to On, an alarm is triggered when the depth drops below the value that you specify. This option is only available when a sonar module is detected.</p> <p>Note: The Fishfinder Shallow alarm limit cannot be set to a value greater than the Deep Limit.</p>	<p>Fishfinder Shallow</p> <ul style="list-style-type: none"> • Off (default) • On <p>Shallow Limit</p> <ul style="list-style-type: none"> • 2 ft (or equivalent units) to the maximum of the transducer range
Fish	<p>If the Fish alarm and fish depth limits alarm are set to On, a warning sounds is triggered if any target meets the sensitivity level and is within the Shallow Fish Limit and Deep Fish Limit that you specify. The following items are available in the sub-menu:</p> <ul style="list-style-type: none"> • Fish — Switches fish alarm On and Off. • Fish Sensitivity — If the Fish alarm is set to On, an alarm is triggered when the fish return strength reaches the sensitivity that you specify. • Fish Depth Limits — Switches depth limits On and Off. • Shallow Fish Limit — Specifies the lower value for the Fish Alarm Depth Limit. 	<p>Fish</p> <ul style="list-style-type: none"> • Off (default) • On <p>Fish Sensitivity</p> <ul style="list-style-type: none"> • 1 to 10 <p>Fish Depth Limits</p> <ul style="list-style-type: none"> • On • Off (default)

Menu item	Description	Options
	<ul style="list-style-type: none"> • Deep Fish Limit — Specifies the upper value for the Fish Alarm Depth Limit. 	<p>Shallow Fish Limit</p> <ul style="list-style-type: none"> • 2 ft (or equivalent units) to the maximum of the transducer range <p>Deep Fish Limit</p> <ul style="list-style-type: none"> • 2 ft (or equivalent units) to the maximum of the transducer range
Fuel Manager	In the fuel manager alarm options you can switch the low fuel warning alarm on or off and specify the fuel level at which the alarm is triggered.	<p>Low Fuel</p> <ul style="list-style-type: none"> • On • Off (default) <p>Fuel Level</p> <ul style="list-style-type: none"> • 0 to 99999
Guard Zone	The Guard Zone feature in the radar application triggers an alarm when a target is within a specified zone. You can adjust the sensitivity of the alarm. Ensure that the sensitivity is not set too low, or targets may be missed and the alarm will not be triggered.	<p>Guard Zone Sensitivity</p> <ul style="list-style-type: none"> • 1% to 100%
Off Track	When set to On, during active navigation an alarm is triggered when your vessel steers off-track more than the value you specify for the Off Track XTE setting.	<p>Off Track Alarm</p> <ul style="list-style-type: none"> • Off (default) • On <p>Off Track XTE</p> <ul style="list-style-type: none"> • 0.01 to 9.99 nm (or equivalent units)
Sea Temperature	When set to On, triggers an alarm when the sea temperature is equal to or lower than the limit you specify for the Lower Temp Limit or equal to or greater than the limit you specify for the Upper Temp Limit setting.	<p>Sea Temperature</p> <ul style="list-style-type: none"> • Off (default) • On <p>Lower Temp Limit</p> <ul style="list-style-type: none"> • 60 degrees fahrenheit (or equivalent units) • -09.9 to +99.7 degrees fahrenheit (or equivalent units) <p>Upper Temp Limit</p> <ul style="list-style-type: none"> • 75 degrees fahrenheit (or equivalent units) • -09.7 to 99.9 degrees fahrenheit (or equivalent units)
Waypoint Arrival	When you arrive at a waypoint, an alarm is triggered. This setting allows you to specify the distance from the target waypoint at which the alarm is triggered. The units used for this setting are based on the units you specify for distance in the Units Set-up menu.	0.01 to 9.99 nm (or equivalent units)

Accessing the alarms menu

From the homescreen:

1. Select **Set-up**.
2. Select **Alarms**.
The Alarms menu is displayed.
3. Select the appropriate alarm category.

SWIB

Chapter 11: Using waypoints, routes and tracks

Chapter contents

- [11.1 Waypoints on page 108](#)
- [11.2 Routes on page 113](#)
- [11.3 Tracks on page 116](#)
- [11.4 Waypoints, routes and tracks storage capacity on page 118](#)

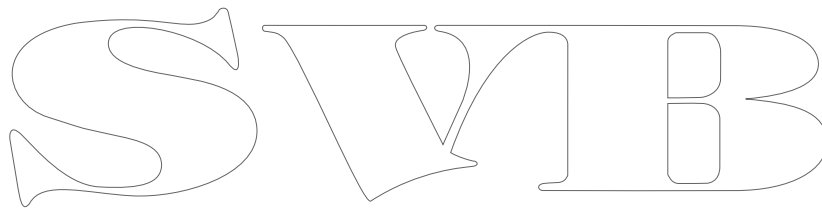
The image shows the letters 'SWIB' in a large, stylized, outlined font. The letters are white with a black outline. The 'S' is a simple, rounded shape. The 'W' is composed of two 'V' shapes joined at the top. The 'I' is a simple vertical bar. The 'B' is a simple, rounded shape with a vertical bar in the middle.

11.1 Waypoints

A waypoint is a position marked on the screen to indicate a site or a place to navigate to.

As well as acting as position markers, waypoints are also the building blocks used to create routes.

Common waypoint functions are accessed using the waypoints menu. This can be shown at any time by selecting **WPT**.

Waypoint display examples

Waypoints in the chart application

In the chart application both active and inactive waypoints are shown. The active waypoint (i.e. the one you are heading towards) has the box and symbol colors reversed.



Item	Description
1	Inactive waypoint
2	Active waypoint
3	Alternative waypoint symbols

By default, all waypoints are indicated on screen by a waypoint symbol (x). You can assign different symbols if required, or choose which waypoints are shown.

Waypoints in the radar application

In the radar application both active and inactive waypoints are shown. The active waypoint (i.e. the one you are heading towards) has the box and symbol colors reversed.

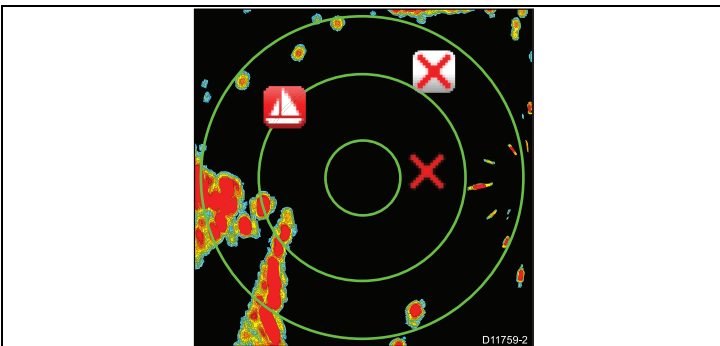

By default, all waypoints are indicated on screen by a waypoint symbol (x). You can assign different symbols if required, or choose which waypoints are shown.

Waypoints in the fishfinder application

Waypoints in the fishfinder application are represented by a vertical line labelled WPT.

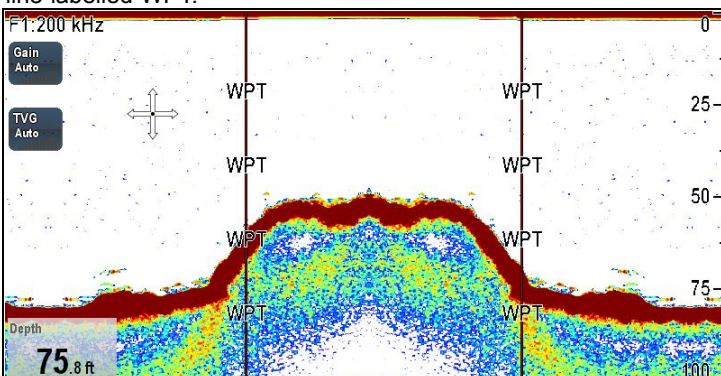

Showing and hiding waypoint groups / symbols

From the chart or radar application:

1. Select **WPT**.
2. Select **Display Wpts on: Chart**, or **Display Wpts on: Radar** depending on the application you have open.
3. The Display Waypoints list is displayed.
4. Select **Change** to switch between Groups and Symbols. A list of Symbols or Groups is displayed.
5. Select the Group or Symbol you wish to show/hide from the list. Selecting on the Symbol/Group will switch between Show and Hide.
6. Repeat Step 5 for each waypoint group or symbol you want to show or hide.

The list of waypoints and symbols can also be accessed from the Chart and Radar applications menu:

- Chart application: **Menu > My Data > Display My Data > Select WPTs To Display**.
- Radar application: **Menu > Presentation > Select WPTs To Display**.

Waypoint context menu

Placing the cursor over a waypoint in the chart or radar applications displays a context menu showing the waypoint's positional data and menu items.

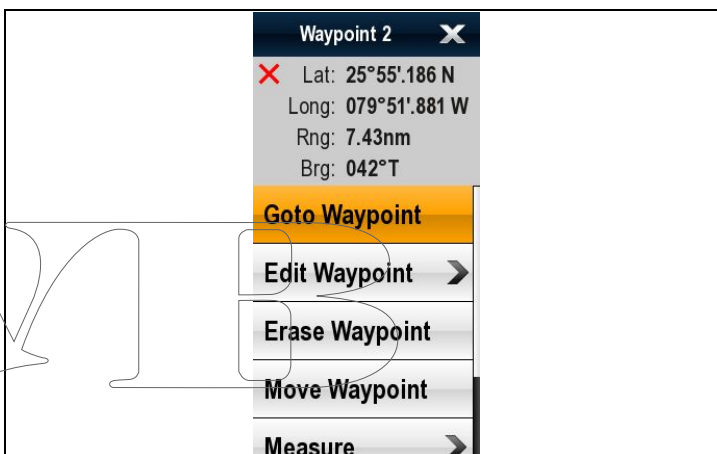

The context menu provides the following positional data for the waypoint in relation to your vessel:

- Latitude
- Longitude
- Range
- Bearing

For inactive waypoints the following menu items are available:

- **Goto Waypoint**
- **Follow From Here** (only available when waypoint is part of a route.)
- **Edit Waypoint**
- **Erase Waypoint**
- **Remove Waypoint** (only available when waypoint is part of a route.)
- **Move Waypoint**
- **Measure**
- **Build Route**
- **Acquire Target** (only available if Radar overlay is switched on.)
- **Slew thermal camera** (only available when thermal camera is connected and operating.)

For active waypoints the following menu items are available:

- **Stop Goto**
- **Restart XTE**

- **Advance Waypoint**
- **Measure**
- **Build Route**
- **Acquire Target** (only available if Radar overlay is switched on.)
- **Slew thermal camera** (only available when thermal camera is connected and operating.)

Accessing the context menu

You can access the context menu by following the steps below.

1. New e Series or New c Series:
 - i. Selecting a location, object or target on-screen and pressing the **Ok** button.
2. Touchscreen multifunction displays:
 - i. Selecting an object or target on-screen.
 - ii. Selecting and holding on a location on-screen.

Waypoint features

There are a range of features for placing, navigating and managing waypoints.



Waypoint features are accessed from:

- **the waypoint context menu** — by positioning the cursor over an existing waypoint on the screen.
- **any application** — by pressing the **WPT** button (New c Series and New e Series) or the **WPT** icon (New a Series). This displays the **Waypoints** menu.
- **the chart application** — by going to the following menu: **Menu > My Data**.
- **the homescreen** — by going to the following menu: **My Data**.

Note: Pressing the **WPT** button or the **WPT** icon from the homescreen will open the waypoint list.

Waypoint (MOB) button / icon

Depending on the multifunction display variant there will be either a Waypoint (MOB) button or an on-screen icon.

WPT button		<ul style="list-style-type: none"> • New c Series • New e Series
WPT icons		<ul style="list-style-type: none"> • New a Series

Throughout this manual the term: Select **WPT**, refers to pressing the physical **WPT** button or pressing the on-screen **WPT** icon.

Waypoint placement



Placing a waypoint

You can place a waypoint on a touchscreen multifunction displays by following the steps below.

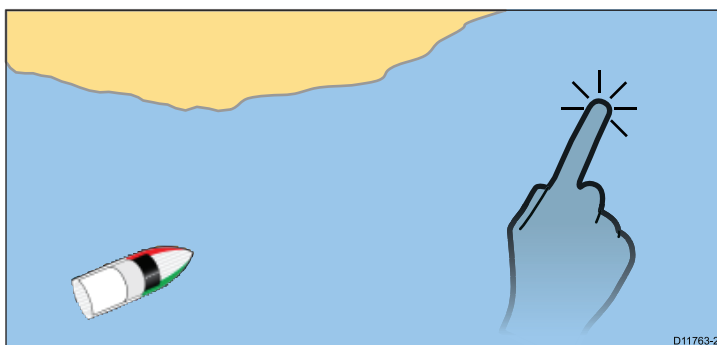

From the chart, radar or fishfinder application:

1. Select and hold the required location on screen.
The context menu is displayed.
2. Select **Place Waypoint**.



Placing a waypoint

From the chart, radar or fishfinder application:

1. Position the cursor at the required position.
2. Press the **WPT** button.
The chart context menu is displayed.
3. Select **Place Waypoint**.
The waypoint is placed at the location and a confirmation pop up message is displayed.
4. Select **Ok** to confirm waypoint placement, or **Edit** to edit the waypoint details.

Placing a waypoint at your vessel's position

In addition to positional information, a waypoint placed at the vessel position will capture temperature and sounded depth information (if you have the appropriate sensors connected to your system).

From the chart, radar or fishfinder application:

1. Select **WPT**.
The waypoint menu is displayed.
2. Select **WPT** again.
A confirmation pop up message is displayed.
3. Select **Ok** to place the waypoint, or **Edit** to edit the waypoint details.

Note: Alternatively with the waypoint menu displayed you can select **Place Waypoint At Vessel**.

Placing a waypoint at a known position

You can place a waypoint at a specified location using latitude and longitude coordinates:

1. Select **WPT**.
2. Select **Place Waypoint At Lat/Lon**.
3. Select the **Position** field.
4. Enter the Latitude/Longitude position.
5. Select **SAVE**.
6. You can also add a name for the waypoint and add to a group by selecting the **Name** and **Group** fields.

Navigation

Navigating to a location on the chart

From the chart application:

1. Select the required location on-screen.
The chart context menu is displayed.
2. Select **Goto Cursor**.

Navigating to the cursor position on the chart using the menu

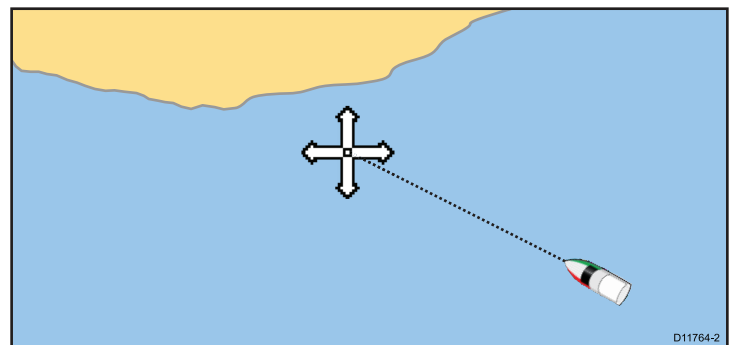

From the chart application:

1. Position the cursor at the desired destination on the chart.
2. Select **Menu**.
3. Select **Navigate**.
4. Select **Goto Cursor**.

Navigating to a waypoint on the screen

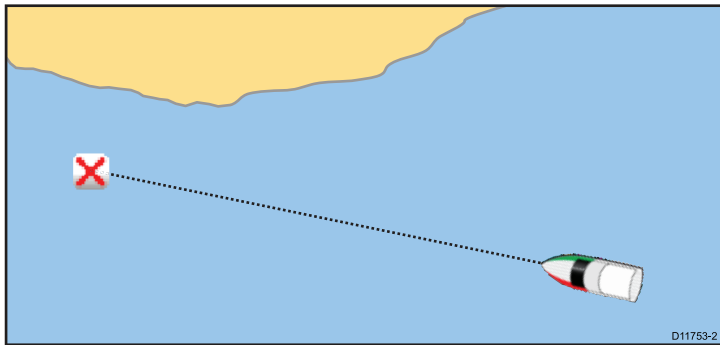

From the chart or radar application:

1. Select the waypoint.
The waypoint context menu is displayed.
2. Select the **Goto Waypoint**.

Note: With an active waypoint selected you can select **Stop Goto** option from the waypoint context menu at any time to cancel the action.

Navigating to a waypoint in the waypoints list

From any application:

1. Select **WPT**.
The waypoint menu is displayed.
2. Select **View Waypoint List**.
The waypoints list is displayed.
3. Select the required waypoint.
The waypoint options dialog is displayed.
4. Select **Goto Waypoint**.

Note: Selecting **WPT** from the homescreen will take you to the waypoints list.

Cancelling navigation to a waypoint

From the chart or radar application:

1. Select the active waypoint.
The waypoint context menu is displayed.
2. Select **Stop Goto**.
3. Alternatively, in the chart application, go to: **Menu > Navigate > Stop Goto**.

Note: Once navigation is no longer active, the waypoint symbol returns to its normal state, and the dashed line between your vessel and the waypoint is removed.

Arriving at a waypoint

As your vessel approaches a waypoint, the waypoint arrival alarm provides a warning.

1. Select **Ok** on the waypoint arrival alarm pop up message.
- Once the alarm is acknowledged, the next waypoint is selected, and the display updates to indicate the next leg of the route.

Note: You can set the approach distance (radius) at which the waypoint arrival alarm will sound using the **Alarms** menu from the homescreen: **Set-up > Alarms > Waypoint Arrival**.

Cross Track Error (XTE)

Cross Track Error (XTE) is the amount of deviation from your intended route or waypoint, expressed as a distance.

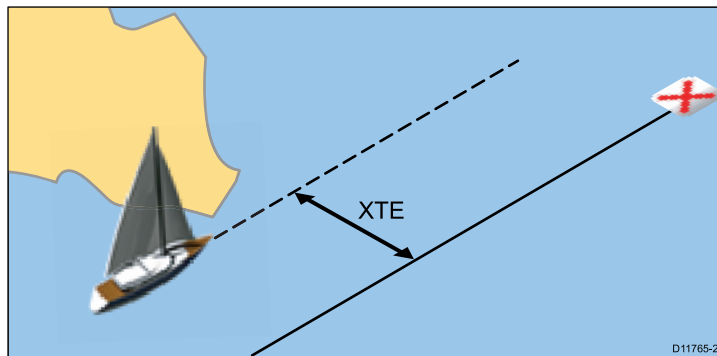

In the event that you steer off-track, you can go straight to your target by resetting XTE.

Resetting Cross Track Error (XTE)

While following a route in the chart application:

1. Select the route.
The route context menu is displayed.
2. Select **Restart XTE**.

Resetting XTE results in a new course from the current vessel position to the current target waypoint. This does not affect your saved route.

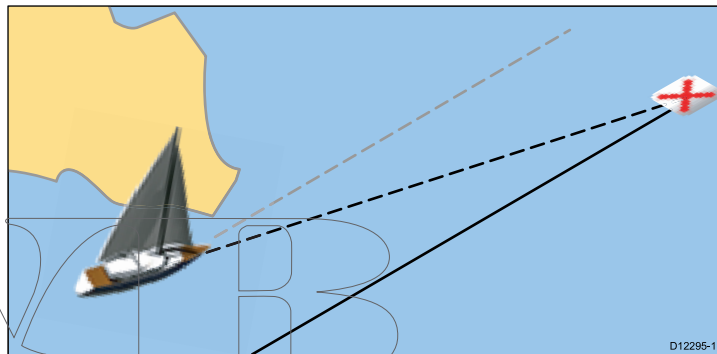

You can also reset the XTE from the Navigate Menu: **Menu > Navigate > Restart XTE**.

Waypoint information

When you create a waypoint, the system assigns information regarding the location marked. You can view and edit the details of any waypoint that has been created and stored.

The following information is assigned or captured for each waypoint:

- Name
- Position (as Lat/Lon and range/bearing from vessel.)
- Temperature (requires appropriate sensor, only for waypoints captured at the vessel position.)
- Depth (requires appropriate sensor, only for waypoints captured at the vessel position.)
- Date and time
- Comment (you can add your own text comments to a waypoint.)
- Symbol (a default symbol is assigned, or you can select an alternative.)

There are 2 features which allow you to view or edit waypoint information:

- Place the cursor over a waypoint on the 2D chart or Radar screen to view selected information.
- Use the waypoint list for comprehensive information to view and edit as required.
- You can allocate waypoints to a waypoint group to make waypoint management easier.

Displaying the waypoint list

1. Select **WPT**.
2. Select **View Waypoint List**.
The waypoint list is displayed.

Note: You can also access the waypoint list from the homescreen and chart application by going to the **My Data** menu and selecting **Waypoint List**.

Waypoint editing

Editing waypoint details

With the Waypoint List displayed:

1. Select the waypoint you want to edit.
The waypoint options dialog is displayed.
2. Select **Edit Waypoint**.
3. Select the field you want to edit: Name, Group, Position or Comment.
4. Use the on-screen keyboard to make the changes, then select the on-screen keyboard's **SAVE** button.

Editing a waypoint on the chart or radar screen

From the chart or radar application:

1. Select the waypoint.
The waypoint context menu is displayed.
2. Select **Edit Waypoint**.
The edit waypoint dialog is displayed.
3. Select the field you want to edit.
4. Use the on-screen keyboard to make the changes, and then select the on-screen keyboard's **SAVE** key.

Waypoint symbols

There are a range of symbols to represent different waypoint types.

Symbol	Type	Symbol	Type
	Airport		Anchor
	Billfish		Bottom mark
	Bridge		Buoy
	Cans		Car
	Caution		Circle
	Concrete		Cross
	Diamond		Diamond quarter
	Diver down		Diver down (alternative)
	Dolphin		Dot
	Fad		Fish
	Fish (1-star)		Fish (2-star)
	Fish (3-star)		Fish trap
	Hill peak		Ledge
	Lobster		Marker
	Martini		Nuns
	Oil rig		Oyster
	Post		Preferred marks
	Private reef		Public reef
	Reef		Reef ball
	Restriction		Rocks
	Sail boat		Route end

Symbol	Type	Symbol	Type
	Route start		School of fish
	Seaweed		Shark
	Skull		Small fish
	Sport fisher		Square
	Swimmer		Tank
	Top mark		Tower
	Trawler		Tree
	Triangle		Wreck

Changing a waypoint symbol

With the Waypoint List displayed:

1. Select the waypoint.
The edit waypoint dialog is displayed.
2. Select the Symbol field.
3. Select the required symbol in the list.

Moving waypoints

Moving a waypoint on the chart or radar screen

From the chart or radar application:

1. Position the cursor on the relevant waypoint.
The waypoint context menu is displayed.
2. Select **Move Waypoint**.
3. Select the new position for the waypoint.

Moving a waypoint within a route

From the chart application:

1. Position the cursor over the waypoint you want to move.
The waypoint context menu is displayed.
2. Select **Move Waypoint**.
3. Select the new location for the waypoint.

Moving a waypoint by entering new coordinates

With the Waypoint List displayed:

1. Select the waypoint.
The edit waypoint options dialog is displayed.
2. Select **Edit Waypoint**.
3. Select the Position field.
4. Use the on-screen keyboard to make the changes, and then select the on-screen keyboard's **SAVE** key.

Erasing waypoints

Erasing a waypoint on screen

From the chart or radar application:

1. Select the relevant waypoint.
The waypoint context menu is displayed.
2. Select **Erase Waypoint**.
The erase waypoint pop up message is displayed.
3. Select **Yes** to confirm, or **No** to cancel.

Note: If you erase a waypoint which is part of a route the erase waypoint in route pop up message is displayed to warn you that the waypoint will be removed from the route.

Erasing a waypoint using the waypoint list

With the Waypoint List displayed:

1. Select the waypoint you want to erase.
The waypoint options dialog is displayed.

2. Select **Erase Waypoint**.
The erase waypoint pop up message is displayed.
3. Select **Yes** to confirm, or **No** to cancel.

Note: If you erase a waypoint which is part of a route the erase waypoint in route pop up message is displayed to warn you that the waypoint will be removed from the route.

Erasing all waypoints

From the homescreen:

1. Select **My Data**.
2. Select **Erase Data From System**.
3. Select **Erase Waypoints From System**.
The erase waypoints from system dialog is displayed.
4. Select **Erase All**.
The confirm delete pop up message is displayed.
5. Select **Yes** to confirm, or **No** to cancel.

Waypoint groups

In order to make your waypoints easier to manage, you can organize them into groups of your choice. When fishing, for example, you may only wish to see the waypoints that indicate good fishing sites.

Provided that you have not changed the default group, all waypoints are automatically placed in the default "My Waypoints" group when they are created.

Note: A waypoint can only belong to one group.

Displaying the waypoint group list

From any application:

1. Select **WPT**.
2. Select **Waypoint And Group Options**.
3. Select **View Group List**.

The waypoint group list is displayed.

You can now:

- Make a new waypoint group.
- Rename waypoint groups.
- Erase waypoint groups.

Note: You cannot rename or erase the default **My Waypoints** group.

Making a new waypoint group

With the Waypoint Group List displayed:

1. Select **Add New**.
The on-screen keyboard is displayed.
2. Select the name field.
3. Use the on-screen keyboard to enter the required name for your new waypoint group.
4. select **SAVE**.

Moving waypoints between groups

1. From any application, select **WPT**.
 2. Select **View Waypoint List**.
 3. Select the Waypoint you wish to change the group of.
The waypoint options dialog is displayed.
 4. Select **Edit Waypoint**.
 5. Select the **Group** field.
A list of available waypoint groups is displayed.
 6. Select the group you wish to move the waypoint to.
- The waypoint is moved to the new group.

Note: The Waypoints list can also be accessed from the homescreen by selecting **WPT**.

Renaming a waypoint group

With the Waypoint Group List displayed:

1. Select the group you want to rename.
2. Select **Edit Group Name**.
The on-screen keyboard is displayed.
3. Using the on-screen keyboard, edit the group name.
4. Select **SAVE**.

Changing the default waypoint group or symbol

From the Waypoint And Group Options menu:

- accessed via the homescreen: **My Data > Waypoint And Group Options**, or
 - accessed via the chart application: **Menu > My Data > Waypoint And Group Options**, or
 - accessed from any application: **WPT > Waypoint And Group Options**
1. Select **Select Default Group**.
A list of groups is displayed.
 2. Select the group you want all new waypoints to be placed in by default.
 3. Select **Default Symbol**.
 4. Select the symbol you want all new waypoints to be assigned.

Erasing a waypoint group

When you erase a waypoint group, the group name is erased from the system and the waypoints that were in that group are moved to the My Waypoints group. You can erase any waypoint group except the following:

- the 'My Waypoints' group,
- a group containing an active waypoint,
- a group that contains waypoints that are part of a stored route.

With the Waypoint Group List displayed:

1. Select the waypoint group that you want to erase.
2. Select **Erase Group (But Keep Waypoints)**.
3. Select **Yes** to confirm the action, or **No** to cancel.

Erasing a waypoint group and its waypoints

To erase a waypoint group and all of the waypoints in that group follow the steps below:

From the homescreen:

1. Select **My Data**.
2. Select **Erase from System**.
3. Select **Erase Wpts from System**.
The waypoints group list is displayed.
4. Select The waypoint group that you want to erase.
A confirmation pop-up message is displayed.
5. Select **Yes** to confirm the deletion.
The waypoint group and all waypoints in that group have now been erased from the system.

11.2 Routes

A route is a series of waypoints typically used to assist with passage planning and navigation.

A route is displayed on screen as a series of waypoints linked by a line.

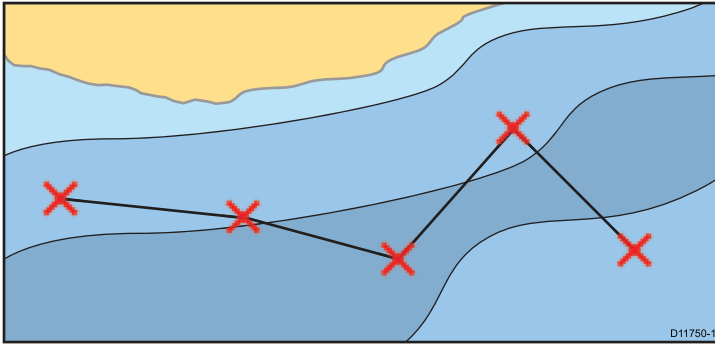

Route features

There are a range of route features for building, navigating and managing routes.

The route features allow you to:

- Build and save a route for use when required (stored in the route list).
- Navigate (follow) routes.
- Manage and edit routes stored on the system.
- Build a route from an existing track.

Route features are accessed from the chart application:

- by selecting an existing route.
- by using the **Build Route** option in the chart context menu.
- by using the chart application menu: **Menu > Navigate > Follow Route**.

Note: The Route List can also be accessed from the homescreen by selecting **My Data** and then **Route List**.

Route building

A route can consist of a combination of:

- New waypoints which you place on the screen as required and/or
- existing waypoints selected from a list displayed on screen.

Note: A route can also be created from a track.

As each waypoint is added, it is assigned an index number corresponding to its position in the route and drawn on the chart using the currently specified symbol. The following should be noted:

- When a route is being built it is not active and does not affect any current navigation.
- You cannot save a new route if any of the waypoints within it are currently active.



Building a route

You can build a route on a touchscreen multifunction display by following the steps below.

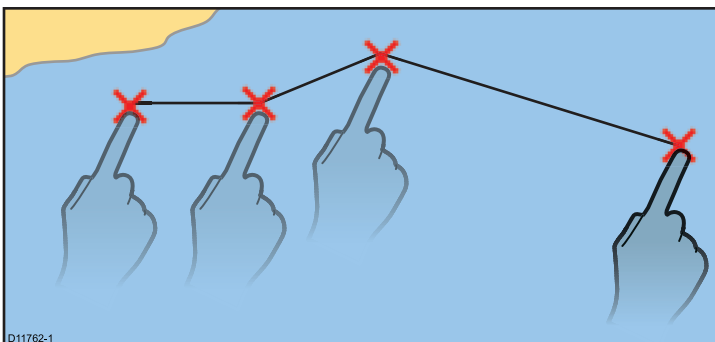

From the chart application:

1. Select and hold a location on screen.
The chart context menu is displayed.
2. Select **Build Route**.
The build route menu is displayed.
3. Select a location on screen to be the starting position.
4. Select relevant locations to place subsequent waypoints in order.
The route is saved and displayed as each waypoint is placed.
5. When complete select **Finish Build**.
The finish route build pop up message is displayed.
6. Select **Follow** to immediately follow the route. or
7. Select **Edit** to change the route name or change the route color. or
8. Select **Exit** to save the route and return to the chart application.

Note: If you place a waypoint at the wrong position, select **Undo Waypoint** from the Route Menu.



Building a route

From the chart application:

1. Select **Menu**.
2. Select **Navigate**.
3. Select **Build Route**.
The build route menu is displayed.
4. Select **Place Wpt**.
5. Using the **Joystick** select a location on screen.
6. Press the **Ok** button to place the first waypoint in the route.
7. Use the **Joystick** and the **Ok** button to place subsequent waypoints.
The route is saved and displayed as each waypoint is placed.
8. When your route is complete select **Finish Build**.
The finish route build pop up message is displayed.
9. Select **Follow** to immediately follow the route. or
10. Select **Edit** to change the route name or change the route color. or
11. Select **Exit** to save the route and return to the chart application.

Note: If you place a waypoint at the wrong position, select **Undo Waypoint**.

Building a route using the waypoint list

From the chart application:

1. Select **Menu**.
2. Select **Navigate**.
3. Select **Build Route**.
The build route menu is displayed.
4. Select **Use WPT List**.
The waypoint list is displayed.
5. Select the required waypoint.
You will be taken back to the build route menu.
6. Add subsequent waypoints to the route.
The route is saved and displayed as each waypoint is placed.
7. When your route is complete select **Finish Build**.
The finish route build pop up message is displayed.
8. Select **Follow** to immediately follow the route. or
9. Select **Edit** to change the route name or change the route color. or
10. Select **Exit** to save the route and return to the chart application.

Note: If you select the wrong waypoint, select **Undo Waypoint** from the route menu.



Adjusting the chart range while building a route

From the Build Route menu:

1. Use the **Range In** and **Range Out** buttons to range in and out of the chart.



Adjusting chart range while building a route

From the Build Route menu:

1. Use the on-screen **Range In** and **Range Out** icons to range in and out of the chart.

Build a route from a track

You can create a route from a recorded track.

When a track is converted the system creates the closest route through the recorded track, using the minimum number of waypoints. Each waypoint created will be saved with the depth and temperature data (if applicable) for that position.

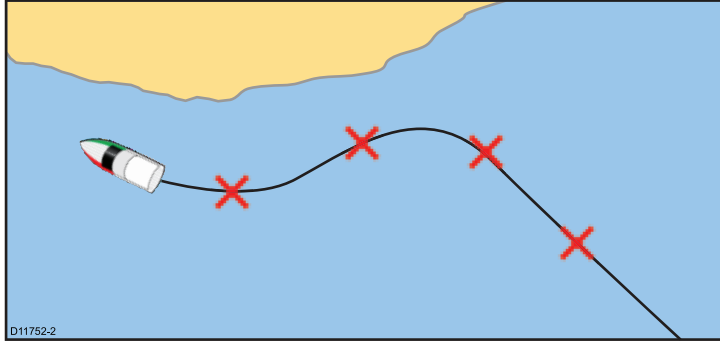

Note: If a track break occurs, only the last segment is converted to a route.

Building a route from a track

From the Track List:

- accessed from the homescreen: **My Data > Track List**
- accessed from the chart application: **Menu > My Data > Track List**

1. Select the Track you want to convert to a route. The track options dialog is displayed.
2. Select **Create Route From Track**.
On completion, the maximum deviation of the route from the recorded track is displayed in a dialog and the new route is added to the route list. It can now be displayed, edited and erased etc. in the same way as other routes in the system.
3. Select **Ok** to confirm.
4. Select **Edit** to change the name and line color of the created route.

Building a route from a track displayed on the chart

From the chart application:

1. Select the required track. The track context menu is displayed.
2. Select **Create Route From Track**.
On completion, the maximum deviation of the route from the recorded track is displayed in a pop up message and the new route is added to the route list. It can now be displayed, edited and erased etc. in the same way as other routes in the system.
3. Select **Ok** to confirm.
4. Select **Edit** to change the name and line color of the created route.

Route context menu

Placing the cursor over a route in the chart application displays a context menu showing the leg of the route highlighted by the cursor and menu items.

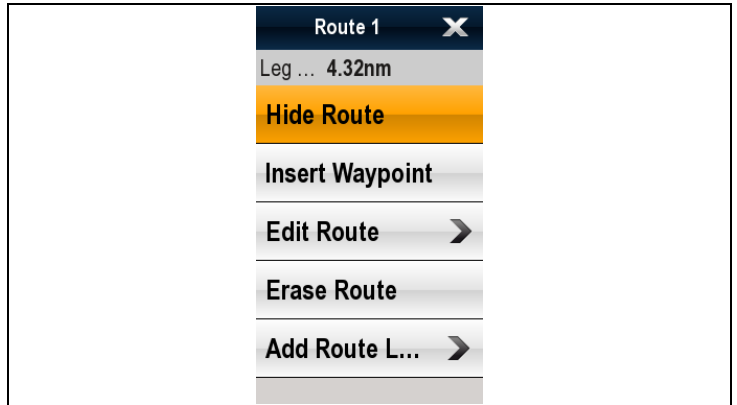

The context menu provides the following menu items:

- **Follow Route**
- **Follow Route In Reverse**
- **Hide Route**
- **Insert Waypoint**
- **Edit Route**
- **Erase Route**
- **Add Route Leg**
- **Acquire Target** (only available if Radar overlay is switched on.)

When following a route the context menu options change to:

- **Stop Follow**
- **Restart XTE**
- **Advance Waypoint**
- **Insert Waypoint**
- **Edit Route**
- **Erase Route** — Disabled
- **Add Route Leg**
- **Acquire Target** (only available if Radar overlay is switched on.)

Accessing the context menu

You can access the context menu by following the steps below.

1. New e Series or New c Series:
 - i. Selecting a location, object or target on-screen and pressing the **Ok** button.
2. Touchscreen multifunction displays:
 - i. Selecting an object or target on-screen.
 - ii. Selecting and holding on a location on-screen.

Navigating a route

You can follow any route stored on the display. When following a route you visit each waypoint in order. You may also use the follow route options in conjunction with a compatible autopilot to automatically navigate along your chosen route.

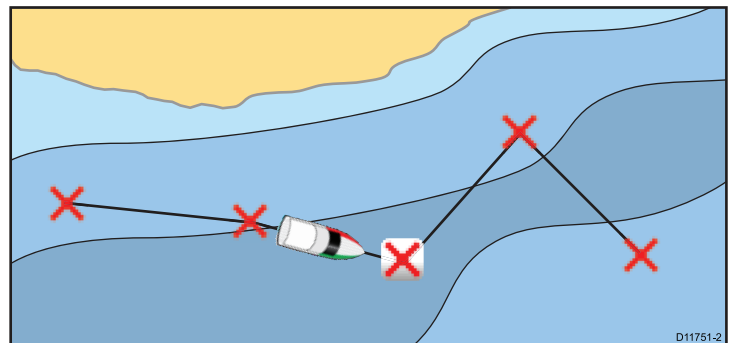

There are a number of ways to select the follow route option:

- Using a stored route within the route list.
- From a selected waypoint or any leg within a route.

You can also follow any route in reverse order.

Following a stored route

From the chart application:

1. Select **Menu**.
2. Select **Navigate**.
3. Select **Follow Route**.
The Route list is displayed.
4. Select the route you want to follow.
5. Select **Follow Route**.

Cancelling navigation of a route

From the chart application:

1. Select the Route.
The route context menu is displayed.
2. Select **Stop Follow**.

Arriving at a waypoint

As your vessel approaches a waypoint, the waypoint arrival alarm provides a warning.

1. Select **Ok** on the waypoint arrival alarm pop up message.

Once the alarm is acknowledged, the next waypoint is selected, and the display updates to indicate the next leg of the route.

Note: You can set the approach distance (radius) at which the waypoint arrival alarm will sound using the **Alarms** menu from the homescreen: **Set-up > Alarms > Waypoint Arrival**.

Advancing to the next waypoint in a route

You can skip the current active waypoint and advance to the next waypoint in a route at any time.

While following a route in the chart application:

1. Select the route.
The route context menu is displayed.
2. Select **Advance Waypoint**.

Note: If the current destination is the last waypoint, the chart advances on to the first waypoint in the route.

Cross Track Error (XTE)

Cross Track Error (XTE) is the amount of deviation from your intended route or waypoint, expressed as a distance.

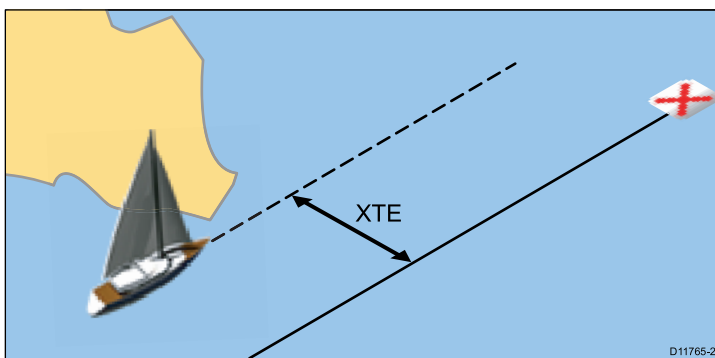

In the event that you steer off-track, you can go straight to your target by resetting XTE.

Resetting Cross Track Error (XTE)

While following a route in the chart application:

1. Select the route.
The route context menu is displayed.
2. Select **Restart XTE**.

Resetting XTE results in a new course from the current vessel position to the current target waypoint. This does not affect your saved route.

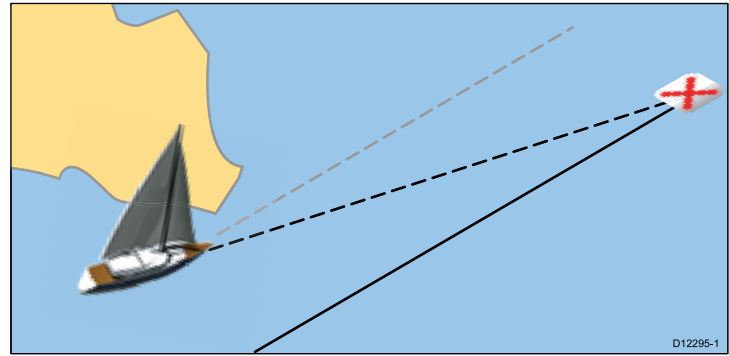

You can also reset the XTE from the Navigate Menu: **Menu > Navigate > Restart XTE**.

Following a route in reverse order

From the chart application:

1. Select the route.
The route context menu is displayed.
2. Select **Follow Route In Reverse**.

You can also select **Follow Route In Reverse** by selecting a route from the route list: **Menu > Navigate > Follow Route**.

Review or edit a route

There are a variety of attributes associated with routes. These can be reviewed and edited.

You can:

- Show or hide a route on the chart screen.
- Review details of the route
- Change the name or color of a route.
- Add, move and remove waypoints from a route.
- Change the route lines width.

Note: An active route can be edited, with the exception of the active waypoint. If a waypoint being edited becomes active, then the system shall cancel the edit; the waypoint shall remain in its original position.

Showing or hiding a route

From the chart application:

1. Select **Menu**.
2. Select **My Data**.
3. Select **Display My Data**.
4. Select **Select Routes To Display**.
The display routes dialog is displayed.
5. Select the route to switch between Show and Hide.

Selecting a route to review or edit

1. Do one of the following to select the required route:
 - With the chart application active, select a route on screen to display the route context menu.
 - With the chart application active, select: **Menu > My Data > Route List** and select the required route from the list.
 - From the homescreen, select: **My Data > Route List** and select the required route from the list.

Adding a waypoint to a route on the chart screen

From the chart application:

1. Select the appropriate leg of the route.
The route context menu is displayed.
2. Select **Insert Waypoint**.
3. Select the location for the new waypoint.
The leg of the route is stretched to include the new waypoint.

Removing a waypoint from a route

From the chart application:

1. Select the waypoint you want to erase.
The waypoint context menu is displayed.
2. Select **Erase Waypoint**.
The erase waypoint pop up message is displayed.

3. Select **Yes** to confirm or **No** to cancel the action.

Moving a waypoint within a route

From the chart application:

1. Position the cursor over the waypoint you want to move.
The waypoint context menu is displayed.
2. Select **Move Waypoint**.
3. Select the new location for the waypoint.

Erasing routes

Erasing a displayed route

From the chart application:

1. Select the route.
The Route context menu is displayed.
2. Select **Erase Route**.
The erase route pop up message is displayed.
3. Select **Yes** to confirm, or **No** to cancel the action.

Erasing a route using the route list

From the chart application menu or the homescreen:

1. Select **My Data**.
2. Select **Route List**.
The route list is displayed.
3. Select the route you want to erase.
4. Select **Erase route**.
The erase route pop up message is displayed.
5. Select **Yes** to confirm, or **No** to cancel the action.

Note: You can delete any route, except for the one that you are currently following. When you erase a route, only those waypoints associated with that route are deleted.

Erasing all routes

From the homescreen:

1. Select **My Data**.
2. Select **Erase Data From System**.
3. Select **Erase Routes From System**.
The erase routes from system dialog is displayed.
4. Select **Erase All**.
The confirm delete pop up message is displayed.
5. Select **Yes** to confirm, or **No** to cancel the action.

11.3 Tracks

A track is an on-screen trail that shows the passage you have taken. This trail is made up of a series of track points which are created automatically. You can save the track to create a permanent record of where you have been

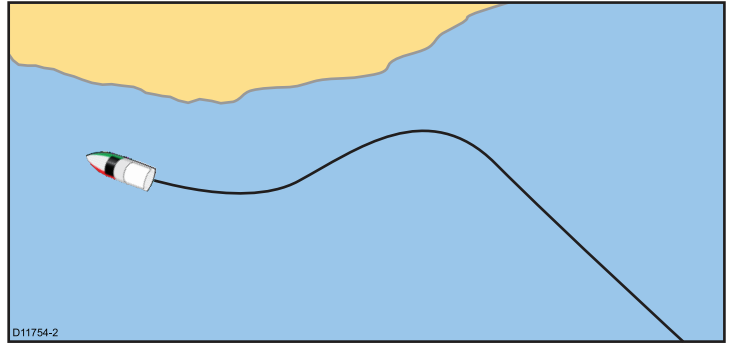

With tracks you can:

- Review where you have been.
- Create a route from a track.

Creating a track

From the chart application:

1. Select **Menu**.
2. Select **Navigate**.
3. Select **Create Track**.
The create track pop up message is displayed.
4. Select **Ok**.

As you navigate your vessel, your journey is automatically recorded as a track.

Note: If the power fails whilst a track is being recorded or the position fix is lost, a break will occur in the track. Only the last segment of a track can be converted into a route.

Note: If the maximum number of tracking points is reached, you will be warned. The track will continue to be recorded with the earlier tracking points being overwritten.

5. To complete your track select **Stop Track** from the **Navigate** menu: **Menu > Navigate > Stop Track**.
The track stopped pop up message is displayed.
6. Select **Save, Erase** or **Cancel**.
 - **Save** — Will save the track and open the Edit track Properties dialog where you can name the track and choose a color for the track line.
 - **Erase** — Will erase the track.
 - **Cancel** — Will cancel the Stop Track action.

Track interval

The track interval specifies the time period or distance between the points in a track.

You can adjust the interval between points which can help ensure best use of the available storage.

The settings are available from the **My Data** menu:

- **Record Track By** — specifies the interval type (Auto / Time / Distance).
- **Track Interval** — specifies the interval value (e.g. 15 minutes).

For example when creating a track for a long journey, an interval set to Auto could result in rapid use of all of the storage available for track points. In this case selecting a higher value for the Track Interval would provide capacity for a longer track.

Setting the track interval

From the chart application:

1. Select **Menu**.
2. Select **My Data**.
3. Select **Track Set-up**.
4. Select **Record Track By** and set to the appropriate value:

- Auto— The track interval is automatically set (Auto will minimize track points whilst maintaining correlation between the track and the actual path followed).
- Time— The track points are placed at regular intervals of time.
- Distance— The track points are placed at regular intervals of distance.

5. Select the **Track Interval** and set to the appropriate value:

- Units of time from the list displayed (available if “record track by” is set to time).
- Units of distance from the list displayed (available if “record track by” is set to distance).
- Not available — no Track Interval is available if the “record track by” is set to auto).

Track context menu

Selecting a track in the chart application displays a context menu showing the track length, number of points and menu items.

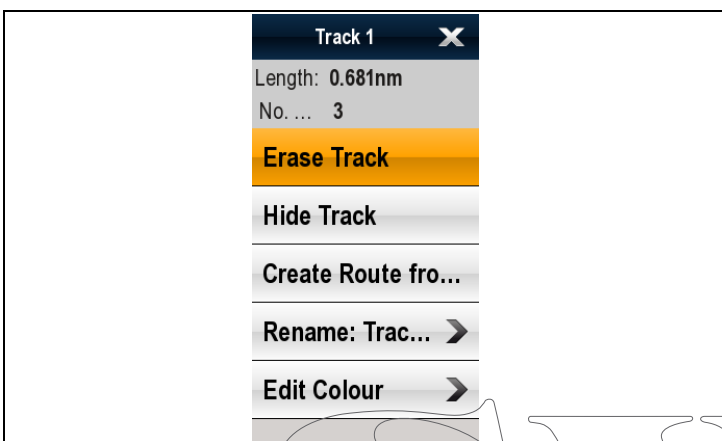

The context menu provides the following menu items:

- **Stop Goto** (only available during active navigation.)
- **Erase Track**
- **Hide Track**
- **Create Route From**
- **Rename**
- **Edit Color**
- **Acquire Target** (only available if Radar overlay is switched on.)

When creating a track the context menu options change to:

- **Stop Goto** (only available during active navigation.)
- **Stop Track**
- **Erase Route** — Disabled
- **Create Route From**
- **Rename**
- **Edit Color**
- **Acquire Target** (only available if Radar overlay is switched on.)

Accessing the context menu

You can access the context menu by following the steps below.

1. New e Series or New c Series:
 - i. Selecting a location, object or target on-screen and pressing the **Ok** button.
2. Touchscreen multifunction displays:
 - i. Selecting an object or target on-screen.
 - ii. Selecting and holding on a location on-screen.

Reviewing and editing a track

You can review and edit aspects of the tracks stored.

You can:

- Erase a track.
- Create a route from a track.
- Show or hide a track on the chart (only available from the chart application).
- Change the name of a track.
- Change the color of a track.

Selecting a track to review or edit

1. Do one of the following to select the required track:

- From the chart application, select a track on screen to display the track context menu.
- From the chart application, go to the following menu: **Menu > My Data > Track List**, and select the required track.
- From the homescreen, select: **My Data > Track List** and select the required track.

You can then proceed and review or edit the required track using the options available.

Erasing tracks

Erasing a track

From the chart application:

1. Select **Menu**.
2. Select **My Data**.
3. Select **Track List**.
The track list is displayed.
4. Select the track you want to erase.
5. Select **Erase Track**.
The erase track pop up message is displayed.
6. Select **Yes** to confirm, or **No** to cancel the action.

Note: You can also erase tracks from the homescreen: **My Data > Track List**.

Erasing all tracks

From the homescreen:

1. Select **My Data**.
2. Select **Erase Data From System**.
3. Select **Erase Tracks From System**.
The erase tracks from system dialog is displayed.
4. Select **Erase All**.
The confirm delete pop up message is displayed.
5. Select **Yes** to confirm, or **No** to cancel the action.

11.4 Waypoints, routes and tracks storage capacity

The display can store the following quantities of waypoints, routes and tracks

Waypoints	<ul style="list-style-type: none">• 3000 Waypoints• 100 waypoint groups
Routes	<ul style="list-style-type: none">• 150 routes, each consisting of up to 50 waypoints.
Tracks	<ul style="list-style-type: none">• 15 tracks, each consisting of up to 10000 track points.

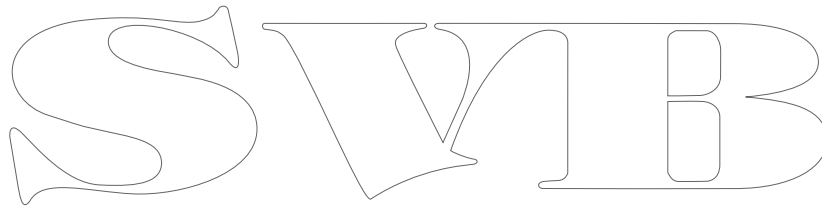
The image shows a stylized outline logo for 'SWIB'. The letters are large, bold, and have a decorative, calligraphic feel. The 'S' is on the left, followed by 'W', 'I', and 'B' on the right. The outlines are thin and black, set against a white background.

Chapter 12: Using the chart

Chapter contents

- [12.1 Chart application overview on page 120](#)
- [12.2 Chart ranging and panning on page 121](#)
- [12.3 Vessel position and orientation on page 122](#)
- [12.4 Chart views on page 124](#)
- [12.5 Chart context menu on page 125](#)
- [12.6 My Data options on page 126](#)
- [12.7 Navigation options on page 126](#)
- [12.8 Measuring distances and bearings on page 127](#)
- [12.9 Chart vectors on page 127](#)
- [12.10 Current information on page 128](#)
- [12.11 Tide information on page 129](#)
- [12.12 Chart object information on page 130](#)
- [12.13 Chart presentation on page 131](#)
- [12.14 Chart set-up menu options on page 135](#)

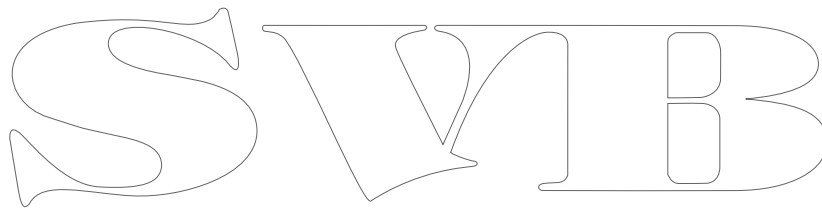

12.1 Chart application overview

The chart application provides an electronic chart with passage planning and navigation features. It combines 2D and 3D viewpoints and provides a variety of cartographic information regarding your surroundings and charted objects.

Typical uses for the chart application include :

- Monitor your vessel location and heading.
- Interpret your surroundings.
- Measure distance and bearing.
- Navigate using waypoints.
- Plan, and Navigate using routes.
- Monitor fixed and moving objects using radar overlay.
- Monitor vessels in your vicinity using AIS data.
- Keep track and record your course.
- View information for charted objects.
- Overlay NOWRad weather information.
- Overlay aerial photos and other chart enhancements

Note: To obtain full 3D detail, you must have chart cards containing 3D cartography for the appropriate geographic area.

You can also use your multifunction display to customize your chart application to your own particular requirements and circumstances. You can:

- Alter the way the chart is drawn in relation to your vessel and the direction you are travelling in (chart orientation and motion mode).
- Manage and edit chart data you have entered.
- Control the level of detail displayed on-screen.

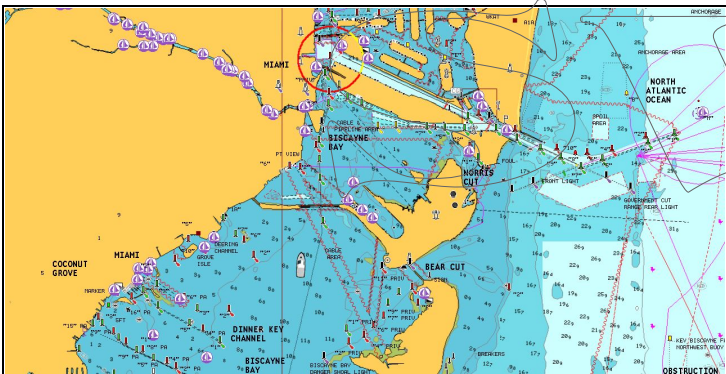

Chart datum

The chart datum setting affects the accuracy of the vessel position information displayed in the chart application.

In order for your GPS receiver and multifunction display to correlate accurately with your paper charts, they must be using the same datum.

The default datum for your multifunction display is WGS1984. If this is not the datum used by your paper charts, you can change the datum used by your multifunction display, using the system preferences page. The system preferences page can be accessed from the homescreen: **Set-up > System Settings > System Preferences > System Datum**.

When you change the datum for your multifunction display, the chart grid will subsequently move according to the new datum, and the latitude/longitude of the cartographic features will also change accordingly. Your multifunction display will attempt to set up any GPS receiver to the new datum, as follows:

- If your multifunction display has a built in GPS receiver it will automatically correlate each time you change the datum.
- If you have a Raymarine GPS receiver using SeaTalk or SeaTalk^{ng}, it will automatically correlate each time you change the datum on the multifunction display.
- If you have a Raymarine GPS receiver using NMEA0183, or a third-party GPS receiver, you must correlate it separately.

It may be possible to use your multifunction display to correlate an NMEA0183 GPS receiver. From the homescreen go to **Set-up > System settings > GPS Set-up > View Satellite Status**. If the datum version is displayed, it may be possible to change it. From the homescreen go to **Set-up > System settings > Data Sources > GPS Datum**.

Note: Raymarine recommends that you check the displayed vessel position in the chart application against your actual proximity to a known charted object. A typical GPS has an accuracy of between 5 and 15 m.

Chart cards overview

Chart cards provide additional cartographic information.

Obtain detailed cartographic information for the area that you navigate using Navionics® chart cards. To check the current availability of Navionics chart card types, please visit www.navionics.com or www.navionics.it. The amount of cartographic detail shown varies for different areas and for different scales. The chart scale in use is indicated by a number and a horizontal line in the status bar — the number represents the distance the horizontal line represents in nautical miles horizontally across the chart.

You can remove and insert chart cards while a chart is displayed provided that you follow the correct procedure. The chart information is retained on-screen until the chart application redraws the screen; for example, when you pan outside the current area, or use the **Range control** to change the chart scale.

Caution: Care of chart and memory cards

To avoid irreparable damage to and / or loss of data from chart and memory cards:

- Ensure that chart and memory cards are fitted the correct way around. DO NOT try to force a card into position.
- DO NOT save data (waypoints, routes, and so on) to a chart card, as the charts may be overwritten.
- DO NOT use a metallic instrument such as a screwdriver or pliers to insert or remove a chart or memory card.
- Safe removal. Always power the unit off before inserting or removing a chart or memory card.

Chart compatibility

Your multifunction display is supplied with a base map and depending on unit a Navionics chart card. You may also purchase Navionics chart cards to get enhanced chart details and additional chart features.

Your multifunction display is compatible with the following Navionics chart cards:

- Ready to Navigate
- Silver
- Gold
- Gold+
- Platinum
- Platinum+
- Fish'N Chip
- Hotmaps

Note: Refer to the Raymarine website (www.raymarine.com) for the latest list of supported chart cards.

Navionics chartplotter sync connection

You can wirelessly synchronize waypoints and routes between the multifunction display and a tablet or smartphone device.

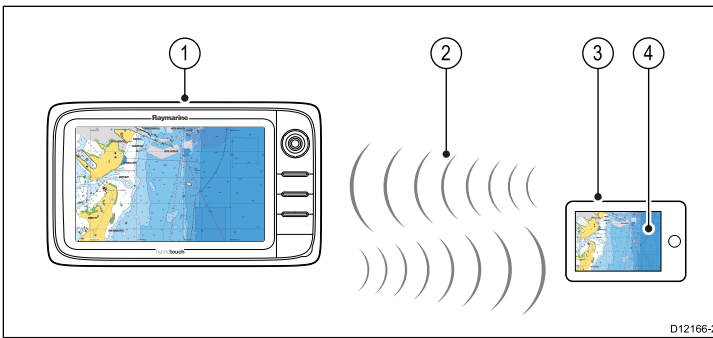

1. Multifunction display.
2. Wi-Fi connection.
3. Tablet / smartphone.
4. Navionics Marine app.



To use this feature you must first:

- Download and install the Navionics Marine app, available from the relevant app store.
- Enable Wi-Fi in the System Settings on the multifunction display.
- Enable Wi-Fi on your tablet / smartphone.
- Select the Raymarine Wi-Fi connection from the list of available Wi-Fi networks on your tablet / smartphone.

12.2 Chart ranging and panning

Ranging in and out

The table below shows the Range controls available for each display variant.

	Rotary Control	<ul style="list-style-type: none"> • New c Series • New e Series
	Range in and Range out buttons	<ul style="list-style-type: none"> • New c Series • New e Series (excluding e7 and e7D)
	Range in and Range out on-screen icons	<ul style="list-style-type: none"> • New a Series • New e Series <div style="border: 1px solid black; padding: 5px; margin-top: 10px;"> <p>Note: New e Series on-screen range controls can be enabled and disabled from the homescreen: Customize > Display Preferences > Range Controls</p> </div>



Panning the chart

You can pan the chart area on a touchscreen multifunction display by following the steps below.

In the chart application:

1. Swipe your finger across the screen from right to left to pan right.
2. Swipe your finger across the screen from left to right to pan left.
3. Swipe your finger across the screen from top to bottom to pan up.
4. Swipe your finger across the screen from bottom to top to pan down.



Panning the chart

You can pan the chart area on a non-touchscreen multifunction display by following the steps below.

From the chart application:





1. Move the **Joystick** in the direction you want to pan.

12.3 Vessel position and orientation

Vessel position on the chart display

Your current position is represented on screen by the vessel symbol.

The symbol used for your vessel will vary depending on the vessel type selected during initial set up of your multifunction display.

Motor Vessels	
Sail Vessels	
Small Vessel	
The vessel symbol will change to a black dot when your vessel is stationary and no heading data is available.	

Note: If positional data has been selected for display, your position will be displayed in the databar under Ves Pos.



Locating your vessel

The vessel icon can be repositioned to the center of the screen by following the steps below.



1. Select the Find Ship icon:  located on the left hand side of the screen.



Locating your vessel

The vessel icon can be repositioned to the center of the screen by following the steps below.

1. Select **Menu**.
2. Select **Find Ship**.

Chart orientation

The orientation of a chart refers to the relationship between the chart and the direction that you are travelling in.

It is used in conjunction with motion mode to control how your vessel and chart relate to one another and how they are displayed on screen.

The mode you choose applies to the active chart instance, and is restored at power up.

The following options are available:

North-Up

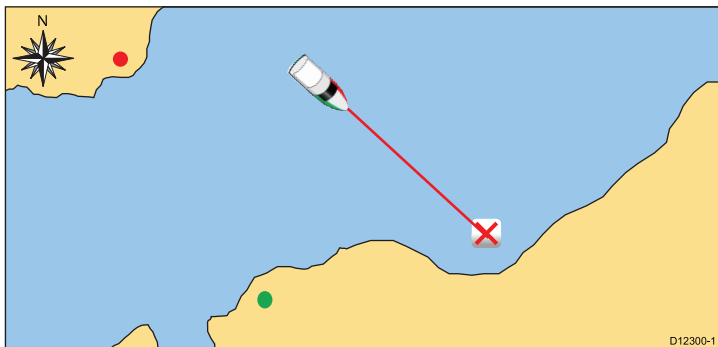

In North Up mode, the chart orientation is fixed with true north upwards. As your heading changes the vessel symbol moves accordingly. This is the default mode for the chart application.

Head-Up

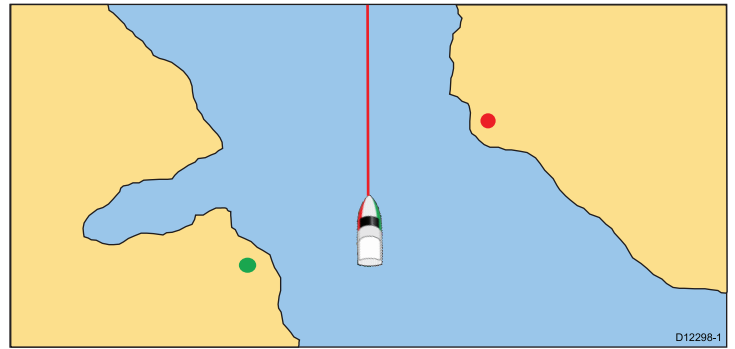

Head Up mode displays the chart with your vessel's current heading upwards. As the heading changes the vessel symbol remains fixed and the chart picture rotates accordingly.

Note: To prevent continuous backwards and forwards rotations as the vessel yaws from side-to-side, the chart will not update unless the heading changes by at least 10 degrees from the last displayed orientation.

Note: It is not possible to select Head Up when the motion mode is set to True.

Course-Up

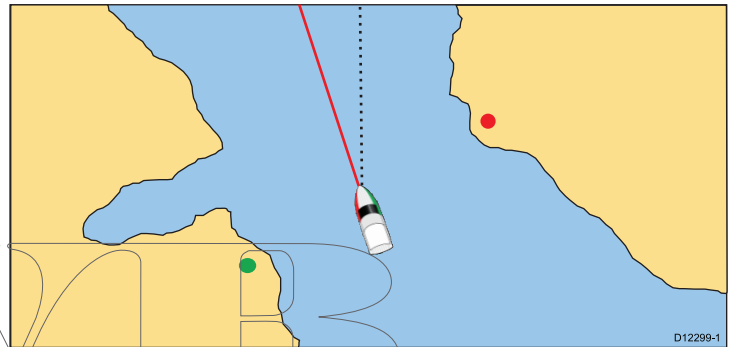

In Course Up mode, the chart picture is stabilized and shown with your current course upwards. As your vessel's heading changes, the ship symbol moves accordingly. If you select a new course, the picture will reset to display the new course upwards. The reference used for Course Up depends upon the information available at a given time. The system always prioritizes this information in the following order:

1. Bearing from origin to destination, i.e. intended course.
2. Locked heading from an Autopilot.
3. Bearing to waypoint.
4. Instantaneous heading.

If heading data becomes unavailable whilst in this mode, a warning pop up message is displayed and the chart uses 0° heading in relative motion.

Setting the chart orientation

From the chart application:

1. Select **Menu**.
2. Select **Presentation**.
3. Select **Chart Orientation**.
4. Select Head Up, North Up, or Course Up option, as appropriate.
Once selected a tick will be placed next to the chosen orientation and the screen will update to reflect the new orientation.

Chart motion mode

The motion mode controls the relationship between the chart and your vessel.

Whilst motion mode is active, as your vessel moves, the chart is redrawn to keep the vessel on-screen. The 3 motion modes are:

- Relative Motion.
- True Motion.
- Auto Range.

Note: In the 3D chart view, only Relative Motion mode is available.

The current motion mode applies to the active instance of the chart application.

When you pan the chart the motion mode is no longer active. This is indicated in the status bar by brackets around the motion mode — for example, (Relative Motion). This enables you to view another area of the chart whilst navigating. To reset the motion mode and return your vessel to the screen, select the **Find Ship** icon or select **Find Ship** from the menu. Manually changing the range or panning the chart in auto range also suspends motion mode. The default setting is relative motion with zero offset. The mode that you select is restored at power up.

Relative Motion with optional vessel offset

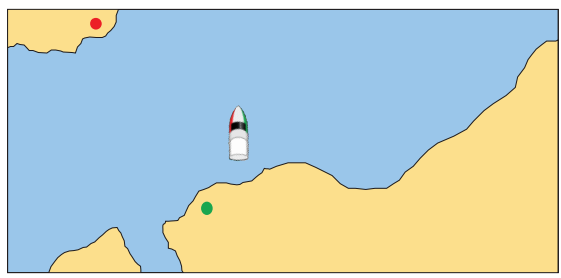
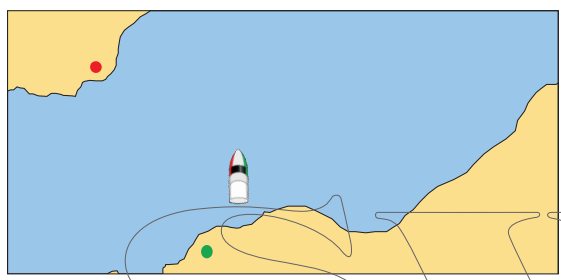
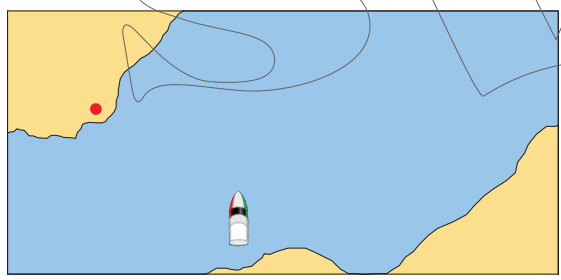
Offset	Example
Zero Offset	
1/3 Offset	
2/3 Offset	

When the motion mode is set to Relative Motion, the position of your vessel is fixed on the screen and the chart picture moves relative to your vessel. You can use the **Menu > Presentation > Vessel Offset** menu item to determine whether the vessel is fixed in the centre of the window (0 offset) or offset by 1/3 or 2/3. If you change the offset to 1/3 or 2/3, the view ahead of your vessel will be increased.

In the example shown above, the motion mode has been set to Relative Motion, with a vessel offset of 1/3. The vessel is fixed in the offset position and the chart moves accordingly:

True Motion

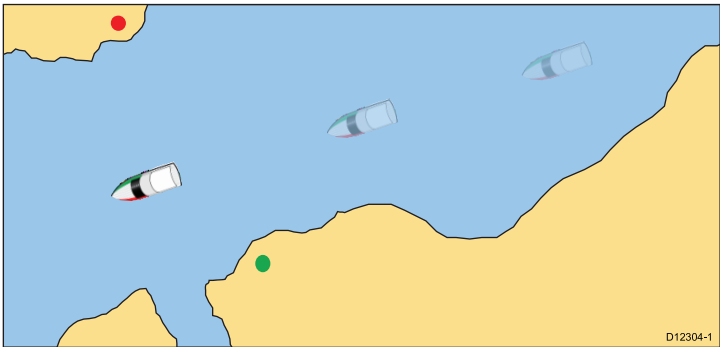

When the motion mode is set to True Motion, the chart is fixed and the vessel moves in true perspective to fixed landmasses on the screen. As the vessel's position approaches the edge of the screen, the chart picture is automatically reset to reveal the area ahead of the vessel.

Note: It is not possible to select True Motion when the orientation is set to Head Up.

Auto Range

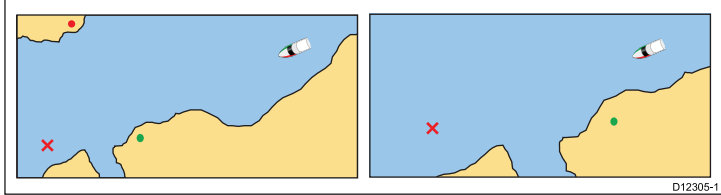

Auto Range selects and maintains the largest possible scale of chart that will display both the vessel and the target waypoint. Auto range is not available if radar-chart synchronization is on.

Setting the motion mode

From the chart application:

1. Select **Menu**.
2. Select **Presentation**.
3. Select **Motion Mode**.
4. Select True Motion, Relative Motion, or Auto Range option as appropriate.

Once selected a tick will be placed next to the chosen motion mode and the screen will update to reflect the new mode.

Changing the vessel offset value

From the chart application:

1. Select **Menu**.
2. Select **Presentation**.
3. Select **Vessel Offset**.
4. Select 0, 1/3, or 2/3 option as appropriate.

12.4 Chart views

Switching between 2D/3D chart view

You can switch between 2D and 3D views.

From the chart application:

1. Select **Menu**.
2. Select **Presentation**.
3. Select **Chart View** to switch between 2D or 3D.

2D chart view

The 2D chart view can display a range of information to help you navigate.

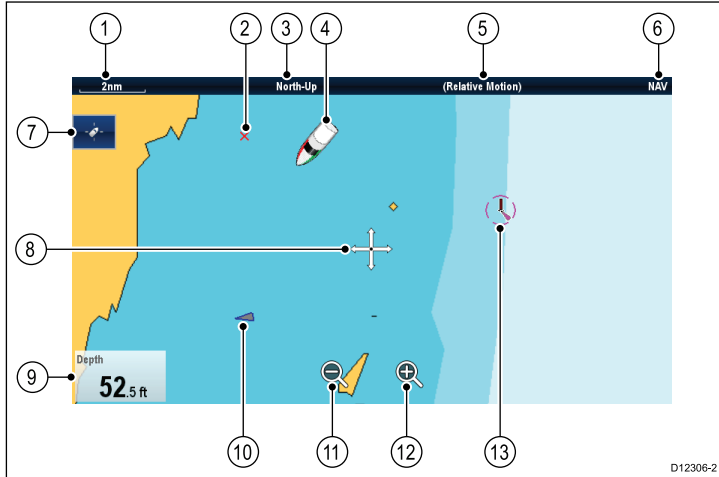

Item	Description
1	Range — horizontal chart scale indicator (shown in selected system units).
2	Waypoint — optional.
3	Orientation — states the orientation mode that the chart is using (North-up, Head-up, or Course-up).
4	Vessel symbol — shows your current position.
5	Motion mode — states the current motion mode (Relative, True, or Auto Range).
6	Chart type — indicates the type of chart in use — Fish or Navigation.
7	Find ship icon — used to find and center your vessel on the chart.
8	Cursor — used to select chart objects and move around the chart area.
9	Data overlay — used to display data such as depth on the chart screen.
10	AIS target — a vessel broadcasting AIS information (optional).
11	Range out — use icon to to range out (New e Series only).
12	Range in — use icon to range in (New e Series only).
13	Cartographic objects — use the Cartography menu: Menu > Set-up > Cartography to choose which objects to display.

3D chart view

The 3D view can display a range of information to help you navigate.

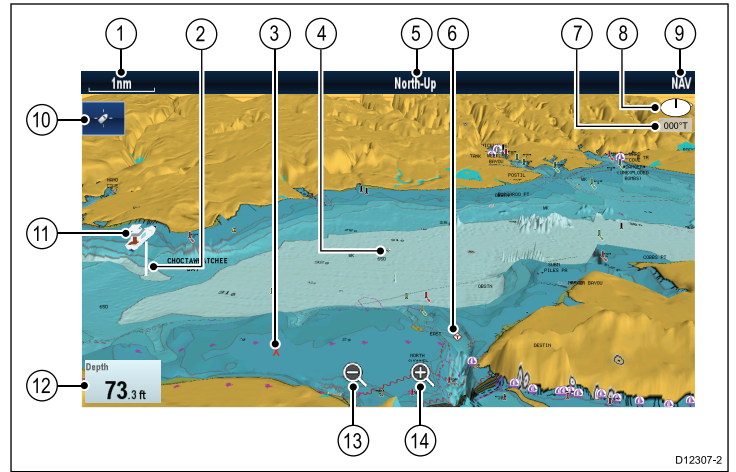

Item	Description
1	Range — horizontal chart scale indicator (shown in selected system units).
2	Depth Scale — approximate depth beneath your vessel (optional).
3	Waypoint — optional.
4	Center-of-view — the white cross indicates the center of chart view at the water level (optional).
5	Orientation — states the orientation mode that the chart is using.
6	Cartographic objects — use the Cartography Set-up menu to choose which objects to display.
7	Rotation — shows in degrees true, how far the on-screen view has been rotated from your vessel's heading and the tilt angle of your vessel.
8	North arrow — 3D indication of True North in relation to the chart view. The north arrow also tilts to indicate pitch angle.
9	Chart type — indicates the type of chart in use — Fish or Navigation.
10	Find ship icon — used to find and center your vessel on the chart.
11	Vessel symbol — your vessel's current position.
12	Data overlay — used to display data such as depth on the chart screen.
13	Range out — use icon to range out (New e Series only).
14	Range in — use icon to range in (New e Series only).

Manipulating the 3D chart view

From the chart application:

1. With the chart in 3D mode, go to the Adjust Viewing Angle menu: **Menu > Adjust Viewing Angle**.
2. Select **Adjust**: so that Pitch and rotate is highlighted.
3. To adjust the pitch:
 - i. New c Series or New e Series — Move the **Joystick Up** or **Down** to adjust the pitch

- ii. New a Series or New e Series — Swipe your finger up or down across the screen to adjust the pitch.

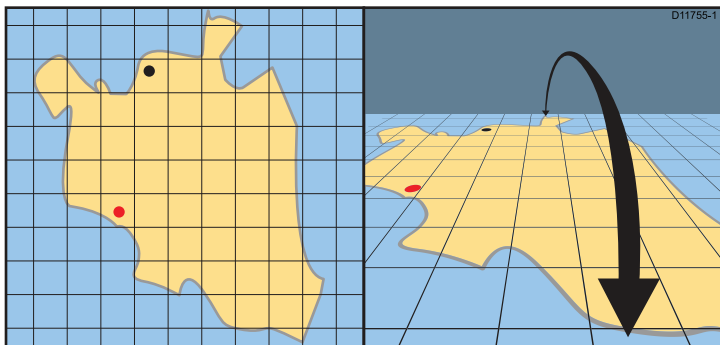

12.5 Chart context menu

Placing the cursor over an area in the chart application displays a context menu showing the cursors positional data and menu items.

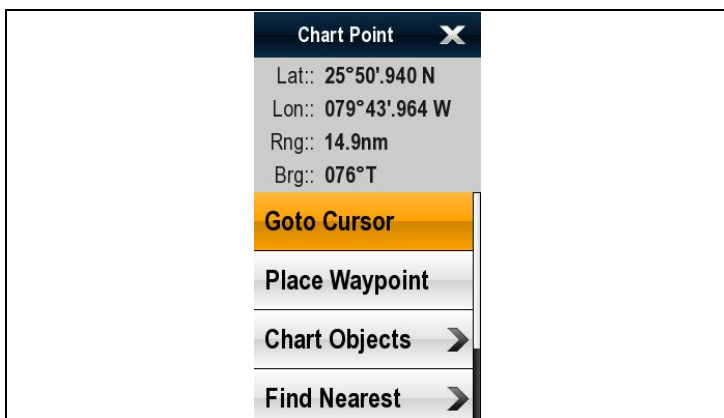

4. To adjust the rotation:

- i. New c Series or New e Series — Move the **Joystick Left** or **Right** to adjust the rotation
- ii. New a Series or New e Series — Swipe your finger left or right across the screen to adjust the rotation.

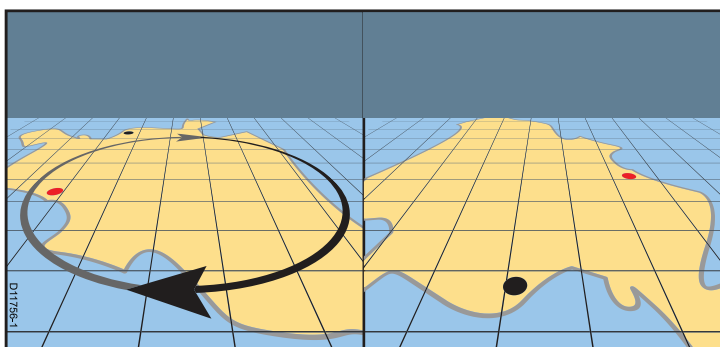

The method of selecting a chart object using touch depends on the **Context Menu** setting in the chart **Set-up** menu, which can be set to Touch or Hold.

The context menu provides the following positional data for the cursor position in relation to your vessel:

- Latitude
- Longitude
- Range
- Bearing

The following menu items are available:

- **Goto Cursor / Stop Goto / Stop Follow**
- **Place Waypoint**
- **Photo**
- **Tide Station** (only available if a tide station is selected.)
- **Current Station** (only available if a current station is selected.)
- **Pilot Book** (only available at certain ports.)
- **Animate** (only available if a tide or current station is selected.)
- **Chart Objects**
- **Find Nearest**
- **Measure**
- **Build Route**
- **Acquire Target** (only available if Radar overlay is switched on.)
- **Slew thermal camera** (only available when thermal camera is connected and operating.)

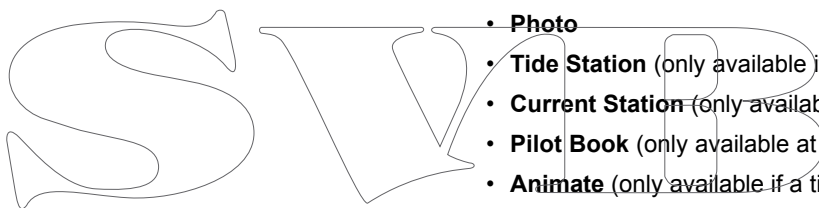

Accessing the context menu

You can access the context menu by following the steps below.

1. New e Series or New c Series:
 - i. Selecting a location, object or target on-screen and pressing the **Ok** button.
2. Touchscreen multifunction displays:
 - i. Selecting an object or target on-screen.
 - ii. Selecting and holding on a location on-screen.

Selecting context menu settings

On touchscreen multifunction displays you can choose how chart object context menus are accessed.

From the chart application:

1. Select **Menu**.
2. Select **Set-up**.
3. Select **Context Menu** to switch between Touch or Hold.
 - **Hold** — requires you to touch and hold on a chart object to access the context menu.
 - **Touch** — requires you to touch a chart object to access the context menu.

12.6 My Data options

The chart provides features to help you manage your data and help plan your navigation to a chosen location.

The options are found in the **My Data** menu: **Menu > My Data**.

- **Waypoint List** — View and edit waypoints stored on the system.
- **Route List** — View and edit routes stored on the system.
- **Track List** — View and edit tracks stored on the system. Start or stop a track.
- **Display My Data** — Allows you to choose which waypoints, routes, or tracks to show or hide in the chart application.
- **Create Track / Stop Track** — Allows you to create a new track or stop a track which is in progress.
- **Tracks Set-up** — Allows you to specify the time period or distance between track points.
- **WPT & Group Options** — View and edit waypoint groups and select default waypoint group and symbol.

Refer to the Using waypoints, routes and tracks section for further details.

12.7 Navigation options

The chart application provides features to help navigate to a chosen location.

The navigation options are found in the Navigate menu: **Menu > Navigate**.

- **Goto Cursor** — Will set the cursor position as the active destination.
- **Goto Waypoint** — Provides options to navigate to a waypoint stored on the system
- **Follow Route** — Provides options to navigate to a route stored on the system
- **Create Track** — Will initiate a track on screen to plot your course as you progress.
- **Build Route** — Provides options to build a route.

Refer to the Using waypoints, routes and tracks section for further details.

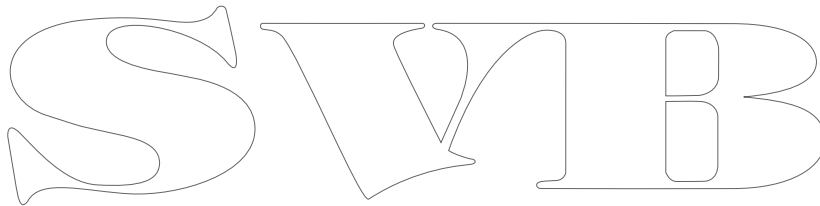

12.8 Measuring distances and bearings

You can use the databar and context menu information you can use the measure function to measure distances in the chart application.

You can determine the distance and bearing:

- from your vessel to the position of the cursor;
- between two points on the chart.

Measuring from vessel position to cursor

From the chart application:

1. Select the location on screen that you want to measure the distance or bearing from your vessel.
The chart context menu will be displayed.
2. Select **Measure**.
The following will happen:
 - The measure menu will be displayed.
 - A line will be drawn from the cursor position to the center of the screen.
 - The cursor location will be moved at the center of the screen.
 - The bearing and distance will be displayed next to the new cursor location.
3. From the measure menu select **From** so that Ship is selected.
The ruler line is re-drawn from the cursor position to your vessel.
4. You can now adjust the ruler position by moving the cursor to the desired location.
5. If you want the ruler displayed after you have closed the measure menu, select **Ruler**: so that On is highlighted.
Selecting ruler will switch the ruler On and Off.
6. Select Back or Ok to close the measure menu leaving the current measurement on-screen.

Measuring from point to point

From the chart application:

1. Select the location on screen that you want to measure the distance or bearing from your vessel.
The chart context menu will be displayed.
2. Select **Measure**.
The following will happen:
 - The measure menu will be displayed.
 - A line will be drawn from the cursor position to the center of the screen.
 - The cursor location will be moved at the center of the screen.
 - The bearing and distance will be displayed next to the new cursor location.
3. Select **From** so that Cursor is selected.
Selecting measure from will switch between Ship and Cursor.
4. You can now adjust the end point by moving the cursor to the desired location.
5. You can also **Swap Direction** of the ruler so that the bearing becomes the bearing from end point to start point.
6. If you want the ruler displayed after you have closed the measure menu, select **Ruler** so that On is highlighted.
Selecting display ruler will switch the ruler On and Off.
7. Select **Back** or **Ok** to exit the measure menu leaving the current measurement on-screen.

Repositioning the ruler

You can reposition a ruler by following the steps below.

1. Select the current ruler.
The ruler context menu is displayed.
2. Select **Measure**.

You can now reposition the ruler as required.

12.9 Chart vectors

Chart vectors display indicators for heading, COG, wind direction and tide direction.

A range of vector graphics can be displayed in the chart application when in 2D chart view. The following vectors can be independently enabled or disabled:

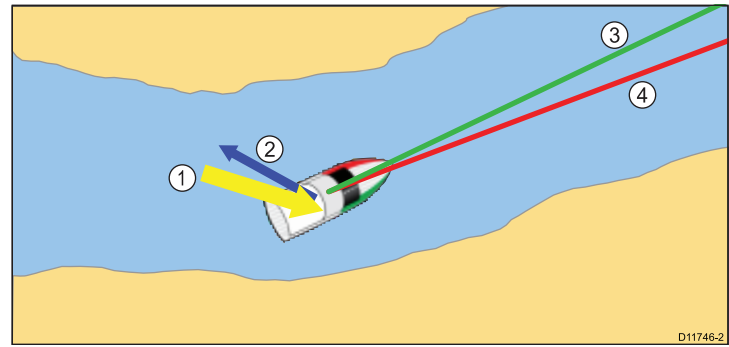

Item	Descriptions
1	Wind arrow — wind direction is displayed as a yellow line with solid arrow heads pointing towards your vessel, indicating the wind direction. The width of the arrow indicates the wind strength.
2	Tide arrow — tide is displayed as a blue line with solid arrow head pointing away from your vessel, in the direction of the tidal set. The width of the arrow indicates the tide strength.
3	COG (Course Over Ground) vector — a green line indicates the vessel's actual course. A double arrow head is used if the vector length is set to a value other than infinite.
4	HDG (heading) vector — a red line shows the vessel's heading. An arrow head is used if the vector length is set to a value other than infinite.

Note: If Speed Over Ground (SOG) or heading data is not available, vectors cannot be displayed.

Vector length

The length of the HDG and COG vector lines is determined by the distance your vessel will travel in the time you specify at your current speed.

Enabling and disabling chart vectors

In 2D chart view:

1. Select **Menu**.
2. Select **Presentation**.
3. Select **Layers**.
4. Select **Vectors**.
5. Select the relevant menu item to switch **Heading Vector**, **COG Vector**, **Tide Arrow**, or **Wind Arrow** On or Off as appropriate.

Setting vector length and width

You can specify the length and width of the heading and cog vectors

In 2D chart view:

1. Select **Menu**.
2. Select **Presentation**.
3. Select **Layers**.
4. Select **Vectors**.
5. Select **Vector Length**.
A list of times is displayed .
6. Select a time setting or select Infinite.
7. Select **Vector Width**.
A list of widths is displayed.
8. Select either Thin, Normal or Wide.

12.10 Current information

Animated current information

The electronic charts may allow animation of the current information current stations.

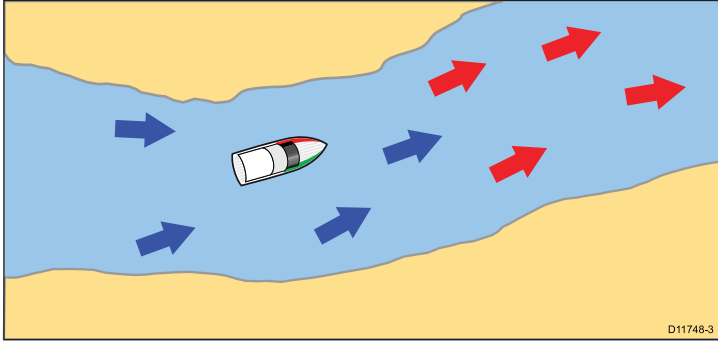

Animated current information is available in the chart application wherever a diamond-shaped symbol with a "C" is displayed:

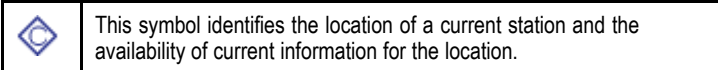

When you select a current station symbol the chart context menu is displayed, which provides the **Animate** option.

When you select **Animate** the animate menu is displayed and the diamond-shaped current symbols are replaced with dynamic current arrows which indicate the direction and strength of the currents:

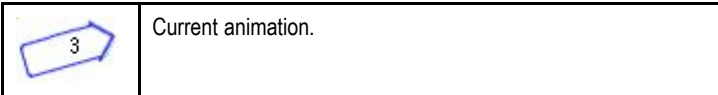

- Arrows indicate the direction of current flows.
- The length of the arrow indicates the flow rate.
- The color of the arrow indicates the flow speed:
 - **Red**: increasing current flow speed.
 - **Blue**: decreasing current flow speed.

The animation can be viewed continuously or incrementally at a time interval that you specify. You can also set the date for the animation, and start or restart the animation at any point within a 24-hour period. If the system does not have a valid date and time the date used will be midday for the system default date.

Note: Not all electronic charts support the animated currents feature. Check the Navionics website: www.navionics.com to ensure the features are available on your chosen cartography level.

Viewing animated current information

From the chart application:

1. Select diamond-shaped current icon.
The chart context menu is displayed.
2. Select **Animate**.
The animate menu is displayed and the current icons are replaced with dynamic current arrows

Controlling animations

From the chart application, with the animate menu displayed:

1. To start or stop the animation, select **Animate**: to switch between Play and Pause.
2. To view the animation in steps, select **Step Back** or **Step Forward**.
3. To set the animation step interval, pause any playing animations, and then select **Set Time Interval**.
4. To set the animation date, select **Set Date** and then using the on screen keyboard enter the required date.
5. To set the animation date to the current date select **Today**.
6. To set the animation date to 24 hours previous to the current date select **Previous Day**.

7. To set the animation date to 24 hours ahead of the current date select **Next Day**.

Displaying details of currents

From the chart application:

1. Select diamond-shaped current icon.
The chart context menu is displayed.
2. Select **Current Station**.
The current graph for the selected current station is displayed.

Current graphs

Current graphs provide a graphical view of current activity.

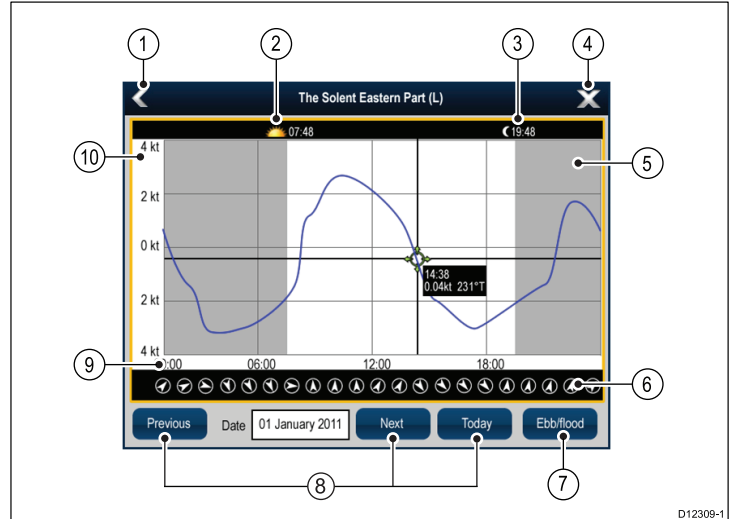

1. **Back** — Return to the previous menu or view.
2. **Sunrise indicator** — Indicates when the sun rises.
3. **Sunset indicator** — Indicates when the sun sets.
4. **Exit** — Closes the dialog.
5. **Nightfall indicator** — The greyed-out section of the graph indicates when nightfall occurs.
6. **Current direction** — Indicates the direction of current (relative to north).
7. **Ebb/Flood** — Displays a list showing ebb, slack and flood tides.
8. **Date navigation** — Use the icons to move to the next or previous day.
9. **Time** — The horizontal axis of the graph indicates time, in accordance with the time format specified in the **Units Set-up** options.
10. **Current speed** — The vertical axis of the graph indicates speed, in accordance with the speed preferences specified in the **Units Set-up** options

Note: The data provided in the current graphs is for information purposes only and should NOT be relied upon as a substitute for prudent navigation. Only official government charts and notices to mariners contain all the current information needed for safe navigation. Always maintain a permanent watch.

12.11 Tide information

Animated tide information

The electronic charts may allow animation of the tide information tide stations.

Animated tide information is available in the chart application wherever a diamond-shaped symbol with a "T" is displayed:

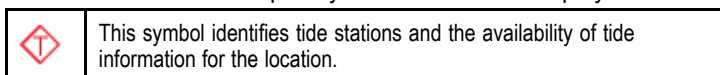

When you select a tide station symbol the chart context menu is displayed, which provides the **Animate** option.

When you select **Animate** the animate menu is displayed and the diamond-shaped symbols are replaced with dynamic tide bar which indicates the predicted tide height for the actual time and date:



- Tide height is indicated by a gauge. The gauge is comprised of 8 levels, which are set according to the absolute minimum / maximum values of that particular day.
- The color of the arrow on the tide gauges indicates changes in the tide height:
 - **Red:** increasing tide height.
 - **Blue:** decreasing tide height.

The animation can be viewed continuously or incrementally at a time interval that you specify. You can also set the date for the animation, and start or restart the animation at any point within a 24-hour period. If the system does not have a valid date and time the date used will be midday for the system default date.

Note: Not all electronic charts support the animated tides feature. Check the Navionics website: www.navionics.com to ensure the features are available on your chosen cartography level.

Viewing animated tide information

From the chart application:

1. Select diamond-shaped tide icon.
The chart context menu is displayed.
2. Select **Animate**.
The animate menu is displayed and the tide icon is replaced with a dynamic tide bar indicator.

Controlling animations

From the chart application, with the animate menu displayed:

1. To start or stop the animation, select **Animate:** to switch between Play and Pause.
2. To view the animation in steps, select **Step Back** or **Step Forward**.
3. To set the animation step interval, pause any playing animations, and then select **Set Time Interval**.
4. To set the animation date, select **Set Date** and then using the on screen keyboard enter the required date.
5. To set the animation date to the current date select **Today**.
6. To set the animation date to 24 hours previous to the current date select **Previous Day**.
7. To set the animation date to 24 hours ahead of the current date select **Next Day**.

Displaying details of tides

From the chart application:

1. Select diamond-shaped tide icon.
The chart context menu is displayed.
2. Select **Tide Station**.
The tide graph for the selected tide station is displayed.

Tide graphs

Tide graphs provide a graphical view of tidal activity.

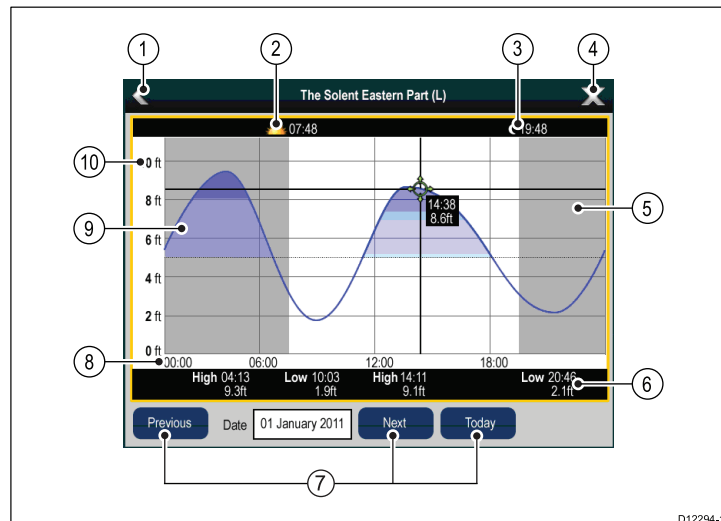

1. **Back** — return to the previous menu or view.
2. **Sunrise indicator** — indicates when the sun rises.
3. **Sunset indicator** — indicates when the sun sets.
4. **Exit** — closes the dialog.
5. **Nightfall indicator** — the greyed-out section of the graph indicates when nightfall occurs.
6. **Low / High Tide** — Indicates the time at which low or high tide occurs.
7. **Date navigation** — Use the icons to move to the next or previous day.
8. **Time** — The horizontal axis of the graph indicates time, in accordance with the time format specified in the System Settings.
9. **Minimum safe depth** — The blue shaded area of the graph indicates the point during the tide cycle when it is safe to navigate your vessel, based on the water depth at that time and the settings you specified for your vessel in the **Minimum Safe Depth** settings in the Customize menu. For example, the diagram above is based on a minimum safe depth setting of 5 ft.
10. **Depth** — The vertical axis of the graph indicates tidal water depth. The units for the depth measurement are based on those specified in the **Homescreen > Customize > Units Set-up > Depth Units** menu.

Note: The data provided in the tide graphs is for information purposes only and should NOT be relied upon as a substitute for prudent navigation. Only official government charts and notices to mariners contain all the current information needed for safe navigation. Always maintain a permanent watch.

12.12 Chart object information

You can display additional information on the chart for cartographic objects, ports, and marinas.

You can also search for the nearest instance of a particular chart object and search for ports by name.

Depending on the chart card you are using, you can view some or all of the following additional information:

- Details of each cartographic object that is marked on the chart, including source data for structures, lines, open sea areas, and so on.
- Details of ports, port features, and business services.
- Pilot book information (similar to what you would see in a marine almanac). Pilot book information is available at certain ports.
- Panoramic photos of ports and marinas. The availability of photos is indicated by a camera symbol on the chart display.

This information can be accessed using the **Chart Objects** or **Find Nearest** options from the chart context menu:

- Select a chart object on screen and choose **Chart Objects** from the chart context menu to view information about the selected object.
- Select **Find Nearest** from the chart context menu to search for objects close by.

Note: The amount of object information available depends upon the electronic charts that you are using for your system. For full details of the features available for your chart cards contact your chart card supplier.

Displaying chart object information

From the chart application:

1. Select an object.
The chart context menu is displayed.
2. Select **Chart Objects** to view detailed information about the selected object
The Object Info dialog is displayed.
3. Selecting the position in the object info dialog will close the information dialog and position the cursor over the object.
4. Selecting available options will display detailed information about that item.

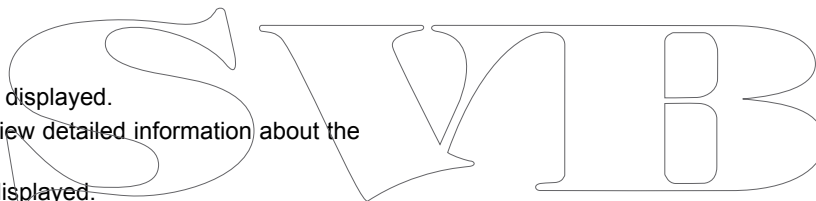

Searching for the nearest chart object or service

From the chart application:

1. Select a location on screen.
The chart context menu is displayed.
2. Select **Find Nearest**.
A list of chart object types is displayed.
3. Select the chart object or service in the list.
A list is displayed of the available instances of that particular object or service.
4. Select the item that you want to find.
The cursor will be repositioned over the selected object or a list of instance will be displayed.

Searching for a port by name

From the chart application:

1. Select a location on screen.
The chart context menu is displayed.
2. Select **Find Nearest**.
A list of chart object types is displayed.
3. Select **Port (search by name)** from the list.
The on-screen keyboard is displayed.
4. Use the on-screen keyboard to enter the desired port name.

5. Select **SEARCH**.

The search results are displayed.

6. Select an entry in the list to display more information.

Displaying pilot book information

From the chart application, when a port symbol is displayed for a port which has a pilot book:

1. Select the port symbol.
The chart context menu will be displayed.
2. Select **Pilot Book**.
3. Select the relevant chapter.

Displaying panoramic photos

From the chart application, when a camera symbol is displayed, indicating the availability of a photo:

1. Select the camera symbol.
The chart context menu is displayed.
2. Select **Photo**.
The photo is displayed on screen.

Note: Not all cartography types are capable of displaying panoramic photos.

12.13 Chart presentation

The chart has a number of presentation options which affect the level of detail, types of objects and aspects of its operation.

The presentation options available are:

- **Chart detail** — Set the level of object detail shown on the chart.
- **Layers** — Set content layers which can be overlaid.
- **Chart View** — Toggle 2D and 3D perspective view.
- **2D Chart Use** — Select fishing charts (if supported by your chosen chart supplier) or standard navigation.
- **Chart Orientation** — Set the orientation of the chart application.
- **Motion Mode** — Set the motion mode for the chart application (only available in 2D view).
- **Vessel Offset** — Set the vessel offset from the centre of the screen (only available in 2D view).
- **Chart Sync** — Synchronize the radar and chart scales.
- **Data Overlay Set-up** — Enable data cells in the chart application.

Accessing chart presentation options

From the chart application:

1. Select **Menu**.
2. Select **Presentation**.

Chart detail

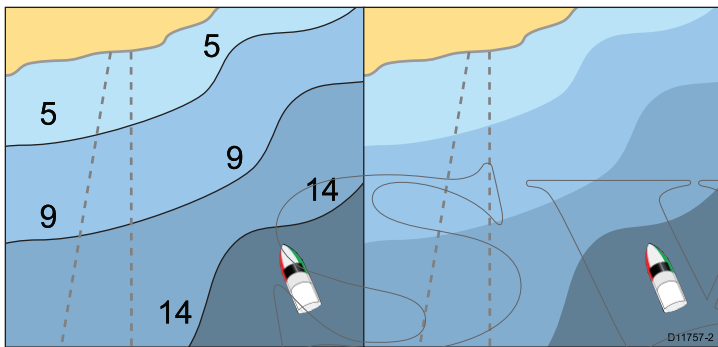

The chart detail setting determines the amount of cartographic detail shown in the chart application.

Selecting the Low option for the **Chart Detail** hides the following cartographic objects:

- Text.
- Chart boundaries.
- Spot soundings.
- Depth contours.
- Light sectors.
- Caution and routing Data.
- Land and marine features.
- Business services (if available for your chart card).

Selecting the High option shows these objects.

Changing the level of chart detail

From the chart application:

1. Select **Menu**.
2. Select **Presentation**.
3. Select **Chart Detail** to switch between the High or Low option, as appropriate.

Chart layers

The chart has a number of content layers providing different kinds of display and information.

You can overlay the following data onto a 2D chart window to give greater depth of information. The overlays available are:

- **Aerial** — Provides an aerial / satellite photography overlay.
- **AIS** — View and track AIS targets (2D view only).

- **Radar** — Overlay radar onto the chart (2D view only).
- **NOWRad** — Provides the NOWRad weather radar overlay, without the need to open a separate weather application window (2D view only).
- **Display My Data** — Allows you to select which waypoints, routes and tracks to display.
- **Vectors** — View heading and COG vectors or tide and wind arrows (2D view only).
- **Range Rings** — View radar range rings (2D view only).
- **Safe Zone Ring** — View safe zone ring (2D view only).
- **Fuel Range Ring** — View the fuel range ring (2D view only).
- **3D Display Options** — Provides 3D options: Centre of View, Exaggeration, Transducer Cone and Depth Scale (3D view only).

Note: The layers require electronic charts with the appropriate feature support and may also require additional hardware and service subscriptions.

Aerial photo overlay

Your electronic charts may include aerial photography.

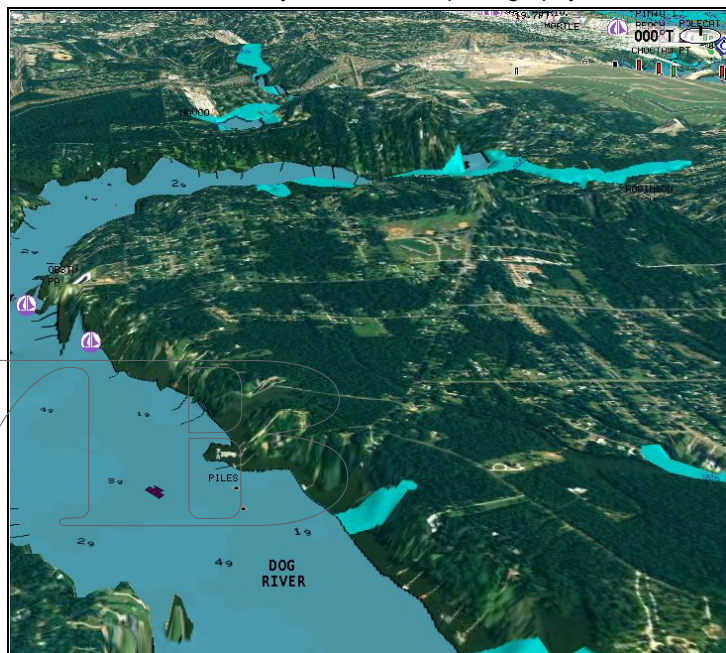

Aerial photos cover the navigable waters up to 3 miles inside the coastline. The resolution is dependent on the region covered by the chart card.

Enabling aerial photo overlay

From the chart application:

1. Select **Menu**.
2. Select **Presentation**.
3. Select **Layers**.
4. Select **Aerial**.

The aerial opacity slider bar control is displayed showing the current opacity percentage.

5. Adjust the slider bar to the required opacity, or
6. Select **Off** to turn the aerial overlay off.

Specifying the aerial overlay area

From the chart application.

1. Select **Menu**.
2. Select **Set-up**.
3. Select **Cartography**.
4. Select **Aerial Overlay**.

A list of overlay options is displayed.

5. Select either **On Land**, **On Land and Shallows**, or **On Land and Sea**.

A tick is displayed next to the option and if aerial overlay is switched on the screen is redrawn showing the new overlay selection.

Radar overlay

You can combine the chart with the radar and MARPA functions to provide target tracking or to help you distinguish between fixed objects and other marine traffic.

You can enhance the use of your chart by combining it with the following radar features:

- MARPA.
- Radar overlay (for distinguishing between fixed and moving objects).

Using the radar to view MARPA targets on the chart

The Mini Automatic Radar Plotting Aid (MARPA) function is used for target tracking and risk analysis. When the radar overlay is on, all MARPA targets are displayed in the chart window and associated MARPA functions can be accessed via the chart.

Using radar overlay to distinguish between fixed and moving objects

You can overlay radar image data over your chart image allowing better distinction between fixed objects and other marine traffic. For best results, switch on Radar-Chart synchronization to ensure radar range and chart scale are synchronized.

Note: In order to use the Radar overlay feature you must use an external source for magnetic heading (e.g. fluxgate compass), you cannot use COG data for radar overlay.

Enabling radar overlay

With the radar turned on and transmitting, with the chart application in 2D view:

1. Select **Menu**.
2. Select **Presentation**.
3. Select **Layers**.
4. Select **Radar**.

The radar overlay opacity slider bar control is displayed showing the current opacity percentage.

5. Adjust the slider bar to the required opacity, or
6. Select **Off** to turn the radar overlay off.

Accessing radar controls on the chart

From the chart application:

1. Select **Menu**.
2. Select **Radar Options**.

Note: Any changes made to the radar options from the chart application will be applied to the radar application.

Chart scale and radar range synchronization

You can synchronize the radar range in all radar windows with the chart scale.

When synchronization is switched on:

- The radar range in all radar windows changes to match the chart scale.
- 'Sync' is indicated in the top left-hand corner of the chart window.
- If you change the radar range, in any radar window, all synchronized chart views change scale to match.
- If you change the scale of a synchronized chart window, all radar windows change range to match.

Synchronizing the chart and radar range

In the 2D chart view:

1. Select **Menu**.
2. Select **Presentation**.
3. Select **Chart Sync**.
4. Select **Radar**.

Note: Radar range synchronization is not available when the chart motion mode is set to AUTORANGE.

NOWRad weather overlay

With a suitable weather receiver connected to your multifunction display, you can overlay NOWRad weather information on the chart display.

The NOWRad weather overlay provides NOWRad weather information and reports in the chart application. You can adjust the intensity of the overlay to achieve optimal visibility of both chart and weather information.

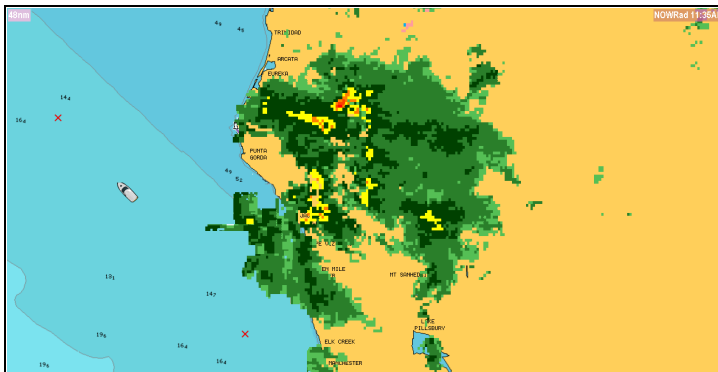

Note: The NOWRad weather overlay can only be used in North America and its coastal waters.

Enabling NOWRad weather overlay on the chart

In the 2D chart view:

1. Select **Menu**.
2. Select **Presentation**.
3. Select **Layers**.
4. Select **NOWRad**.

The NOWRad opacity slider bar control is displayed showing the current opacity percentage.

5. Adjust the slider bar to the required opacity, or
6. Select **Off** to turn the NOWRad overlay off.

Viewing weather reports from the chart application

In the 2D chart view:

1. Select **Menu**.
2. Select **Weather Reports**.
3. Select **Report At** to switch between weather reports from Ship or Cursor location.
4. Select either Tropical Statements, Marine Warnings, Marine Zone Forecasts, or Watchbox Warnings.

Range rings

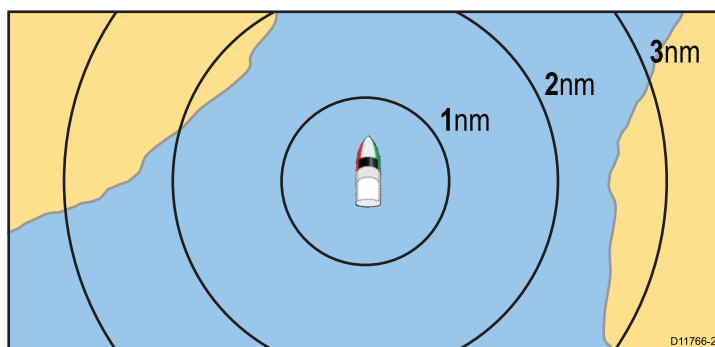

Range rings give you an incremental representation of distance from your vessel to help you judge distances at a glance. The rings are always centred on your vessel, and the scale varies to suit your current zoom setting. Each ring is labelled with the distance from your vessel.

Enabling range rings

In the 2D chart view:

1. Select **Menu**.
2. Select **Presentation**.
3. Select **Layers**.

- Select **Range Rings** so that On is highlighted.
Selecting range rings will switch range rings between On and Off.

Safe Zone Ring

The chart application can display and configure a MARPA / AIS safe zone ring.

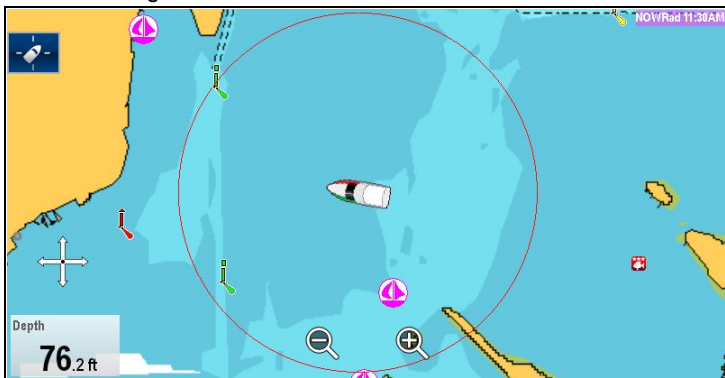

The safe zone ring shares its configuration with the Radar applications safe zone ring, however can be displayed independently of the safe zone ring in the Radar application.

If a MARPA or AIS target will reach the safe zone ring within the time to safe zone selected an alarm is sounded.

Enabling Safe Zones

To show the Safe Zone ring follow the instructions below:

From the chart application go to **Menu > AIS Options > Safe Zone Set-up**

From the radar application go to **Menu > Track Targets > Safe Zone Set-up**

- Select **Safe Zone Ring** so that **Show** is highlighted.
Selecting Safe Zone Ring will switch the zone ring from hidden to visible.
- Select **Safe Zone Radius**.
 - Select the required radius for the safe zone.
- Select **Time to Safe Zone**.
 - Select the required time period.
- Select **AIS Alarm** so that **On** is highlighted.
Selecting AIS Alarm will switch the dangerous target alarm between On and Off.

Fuel range rings

The fuel range ring gives an estimated range that can be reached with the estimated fuel remaining on-board.



The fuel range ring can be displayed graphically in the chart application and indicates an estimated range that can be reached with the:

- Current rate of fuel consumption.
- Estimated fuel remaining on-board.

- Course remaining in a straight line.
- Current speed maintained.

Note:

The fuel range ring is an estimated range that can be reached at the current rate of fuel consumption, of the fuel onboard and based on a number of external factors which could either extend or shorten the projected range.

This estimate is based on data received from external fuel management devices, or via the Fuel Manager. It does not take into account prevailing conditions such as tide, current, sea state, wind etc.

You should not rely on the fuel range ring feature for accurate voyage planning or in emergency and safety critical situations.

Enabling and disabling fuel range ring

From the chart application, in 2D view:

- Select **Menu**.
- Select **Presentation**.
- Select **Layers**.
- Select **Fuel Range Ring**.
Selecting Fuel Range Ring will switch the function On and Off.

3D Display Options

The following options are available with the chart application in 3D view:

- **Centre Of View** — Switches a cross hair on and off at the centre of the screen at sea level.
- **Exaggeration** — Adjusting the exaggeration has the effect of vertically stretching objects on the chart, making it easier to see their shape and position.
- **Transducer Cone** — Switches on and off a transducer cone indicating the coverage of a fishfinder transducer.
- **Depth Scale** — Switches on and off a depth scale at your vessel position.

Enabling centre of view

To enable the centre-of-view cross hair at sea level follow the steps below:

In 3D view:

- Select **Menu**.
- Select **Presentation**.
- Select **Layers**.
- Select **3D Display Options**.
- Select **Centre of View** so that **On** is highlighted.
Selecting centre of view will switch the cross hair on and off.

Adjusting the 3D chart exaggeration

In the 3D chart view:

- Select **Menu**.
- Select **Presentation**.
- Select **Layers**.
- Select **3D Display Options**.
- Select **Exaggeration**.
The Exaggeration numeric adjust control is displayed.
- Adjust the numeric adjust control to the required setting, between 1.0 and 20.0
- Use the **Rotary Control** to adjust the exaggeration to the required setting between 1.0 and 20.0.
- Select **Ok** to confirm setting and close the numeric adjust control.

Enabling transducer cone

To enable the transducer cone to indicate the coverage of your fishfinder transducer follow the steps below:

In 3D view:

- Select **Menu**.
- Select **Presentation**.
- Select **Layers**.

4. Select **3D Display Options**.
5. Select **Transducer Cone** so that On is highlighted.
Selecting Transducer cone will switch the function on and off.

Enabling depth scale

To enable a depth indicator at your vessels location follow the steps below:

In 3D view:

1. Select **Menu**.
2. Select **Presentation**.
3. Select **Layers**.
4. Select **3D Display Options**.
5. Select **Depth Scale** so that On is highlighted.
Selecting depth scale will switch depth indicator on and off.

2D Chart Use

In addition to normal navigation charts Fish mode provides bathymetric contour data on the chart for use during fishing.

Before you can display bathymetric data in the chart application you must have chart cards with the relevant level of detail.

When you change the **2D Chart Use** to the Fish option, bathymetric data is shown on the chart (providing that the chart card contains bathymetric data for that particular location). Certain chart detail is also removed to ensure the bathymetric data can be seen clearly on the chart display.

If the chart card does NOT contain bathymetric data the chart reverts to the default NAV (navigation) data.

Note: Fish mode is not suitable for navigation.

Selecting fish mode

From the chart application:

1. Select **Menu**.
2. Select **Presentation**.
3. Select **2D Chart Use** so that Fish is highlighted.
Selecting 2D chart use will switch the chart between Fish and Navigation modes.

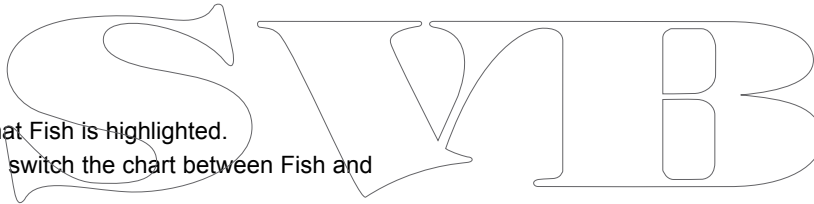

Multiple chart synchronization

You can synchronize the heading, range, and position information across multiple chart views and networked displays.

When chart synchronization is enabled:

- It is indicated by "CHRT Sync" in the chart application title bar.
- Any changes made to the heading, range or position in any chart instance will be reflected in all other chart instances.

Note: When the 2D and 3D chart views are synchronized, the Motion Mode is always Relative Motion.

Synchronizing multiple chart instances

From the chart application:

1. Select **Menu**.
2. Select **Presentation**.
3. Select **Chart Sync**.
4. Select Chart from the list.
A tick is placed next to the selected option.
5. Repeat the steps above for each chart instance and if required on each networked multifunction display you want to sync the chart view.

Note: You cannot sync to another chart if radar sync is turned on.

12.14 Chart set-up menu options

The following table describes the various options in the Chart Set-up Menu for your multifunction display.

Menu item	Description	Options
Context Menu	(Touchscreen displays only) Determines how the context menu is accessed using touch	<ul style="list-style-type: none">• Touch — touching a chart object opens the context menu.• Hold — Touch and holding on a chart object opens the context menu.
Cartography	Provides access to the Cartography menu options.	
Vessel Size	Determines the size of vessel icon displayed in the chart application.	<ul style="list-style-type: none">• Small (default)• Large
Easy View	Easy view increases text size and reduces the number of cartography items displayed to make the chart application more readable.	<ul style="list-style-type: none">• On• Off

Selecting the chart set-up menu

From the chart application:

1. Select **Menu**.
2. Select **Set-up**.

The Chart Set-up menu is displayed.

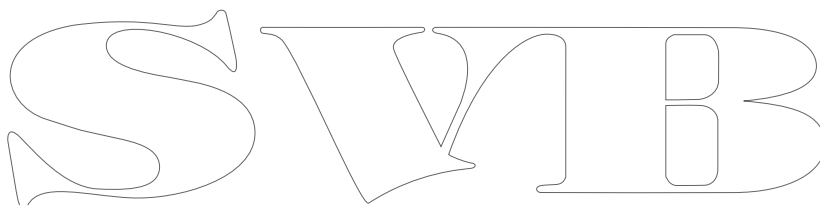

Cartography set-up menu options

The following table describes the various options in the Cartography Set-up Menu for your multifunction display.

Menu item	Description	Options
Chart Display	Determines the level of detail shown on the chart.	<ul style="list-style-type: none"> • Simple • Detailed (default) • Extra Detailed
Chart Grid	Determines whether grid lines representing longitude and latitude are displayed on the chart: <ul style="list-style-type: none"> • Off — grid lines are NOT displayed. • On — grid lines are displayed. 	<ul style="list-style-type: none"> • Off • On (default)
2D Shading	If supported by your chart card, determines whether terrain shading is displayed in 2D view.	<ul style="list-style-type: none"> • On • Off
Community Layer	Determines whether community layer is enabled or disabled. With the community layer turned on, in addition to the standard cartography you will be able to see User Generated Content (UGC). The community layer contains: <ul style="list-style-type: none"> • Modified chart objects — identified by a blue box containing 3 dots. • Added chart objects — identified by a green box containing a plus symbol. • Deleted chart objects — identified by a red box containing a cross symbol. UGC data can be downloaded from the Navionics web store and stored on your Navionics chart card.	<ul style="list-style-type: none"> • On • Off
Chart Text	Determines whether chart text is displayed (place names and so on). <ul style="list-style-type: none"> • Off — chart text is NOT displayed. • On — chart text is displayed. 	<ul style="list-style-type: none"> • Off • On (default)
Chart Boundaries	Determines whether a line indicating the chart boundary is displayed. <ul style="list-style-type: none"> • Off — chart boundary is NOT displayed. • On — chart boundary is displayed. 	<ul style="list-style-type: none"> • Off • On (default)
Spot Soundings	Determines whether a number indicating depth is displayed. <ul style="list-style-type: none"> • Off — depth is NOT displayed. • On — depth is displayed. 	<ul style="list-style-type: none"> • Off • On (default)
Safety Contour	The chart will use this depth as the deep water boundary. Water areas of depth greater than this will be colored using the appropriate Deep Water Color .	<ul style="list-style-type: none"> • Off • 7 ft • 10 ft • 16 ft • 20 ft • 33 ft • 66 ft (default)
Depth Contour	The depth contour is shown on the chart display as a line indicating the depth at a particular position.	<ul style="list-style-type: none"> • Off • 16 ft • 20 ft • 33 ft • 66 ft • All (default)
Deep Water Color	Determines the color used to shade areas of deep water. (The depth used to determine areas of deep water is specified by the Safety Contour setting)	<ul style="list-style-type: none"> • White (default) • Blue
Hide Rocks	Determines whether rocks are displayed in the chart application.	<ul style="list-style-type: none"> • Off (default) • On
Nav. Marks	Determines whether navigation marks are displayed on the chart: <ul style="list-style-type: none"> • Off — navigation marks are NOT displayed. • On — navigation marks are displayed. 	<ul style="list-style-type: none"> • Off • On (default)

Menu item	Description	Options
Nav. Marks Symbols	Determines which set of navigation mark symbols is used — International, or US. These symbols correspond to paper charts.	<ul style="list-style-type: none"> • International (default) • US
Light Sectors	Determines whether the sector of light cast by a fixed beacon is displayed or not. <ul style="list-style-type: none"> • Off — sector of light is NOT displayed. • On — sector of light is displayed. 	<ul style="list-style-type: none"> • Off • On (default)
Routing Systems	Determines whether routing data is displayed or not. <ul style="list-style-type: none"> • Off — routing data is NOT displayed. • On — routing data is displayed. 	<ul style="list-style-type: none"> • Off • On (default)
Caution Areas	Determines whether caution data is displayed or not. <ul style="list-style-type: none"> • Off — caution data is NOT displayed. • On — caution data is displayed. 	<ul style="list-style-type: none"> • OFF • ON (default)
Marine Features	When this menu item is set to On, the following water-based cartographic features are displayed: <ul style="list-style-type: none"> • Cables. • Nature of seabed points. • Tide stations. • Current stations. • Port information. 	<ul style="list-style-type: none"> • Off • On (default)
Land Features	When this menu item is set to On, land-based cartographic features are displayed.	<ul style="list-style-type: none"> • Off • On (default)
Business Services	When this menu item is set to On, symbols indicating the location of a business will be shown.	<ul style="list-style-type: none"> • Off • On (default)
Panoramic Photos	Determines whether panoramic photos are available for landmarks such as ports and marinas.	<ul style="list-style-type: none"> • Off • On (default)
Roads	Determines whether major coastal roads are displayed on the chart: <ul style="list-style-type: none"> • Off — coastal roads are NOT displayed. • On — coastal roads are displayed. 	<ul style="list-style-type: none"> • Off • On (default)
Additional Wrecks	Determines whether extended information for new wrecks is displayed.	<ul style="list-style-type: none"> • Off • On (default)
Aerial Overlay	Determines the areas of the chart covered by the aerial photo overlay feature.	<ul style="list-style-type: none"> • On Land (default) • On Land and Shallow • On Land and Sea
Colored Seabed Areas	Provides greater definition of the seabed. This applies only to limited areas where the extra detail is available.	<ul style="list-style-type: none"> • Off (default) • On

Selecting the cartography set-up menu

From the chart application:

1. Select **Menu**.
2. Select **Set-up**.
3. Select **Cartography**.

The cartography menu options are displayed.

SWIB

Chapter 13: Using radar

Chapter contents

- [13.1 Radar overview on page 140](#)
- [13.2 Radar scan speed on page 141](#)
- [13.3 Radar scanner status symbols on page 141](#)
- [13.4 Radar range and image quality on page 142](#)
- [13.5 Radar display overview on page 144](#)
- [13.6 Dual range radar operation on page 145](#)
- [13.7 Radar mode and orientation on page 146](#)
- [13.8 !\[\]\(36f8637baaa56c4be44b454435949289_img.jpg\) Radar tuning: On-screen gain controls on page 148](#)
- [13.9 Radar adjustments: HD and SuperHD scanners on page 149](#)
- [13.10 Radar adjustments: non-HD digital radomes on page 151](#)
- [13.11 Radar presentation menu options on page 152](#)
- [13.12 Using radar to measure distances, ranges, and bearings on page 154](#)
- [13.13 Using radar to track targets and avoid collisions on page 156](#)
- [13.14 Scanner set-up menu options on page 159](#)
- [13.15 Resetting the radar on page 160](#)

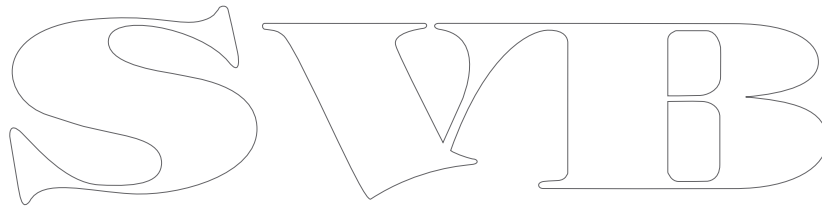

13.1 Radar overview

Radar is used to provide information that can help you to track targets and measure distances and bearings.

Radio Detection And Ranging (RADAR) is used at sea to detect the presence of objects (known as 'targets') at a distance, and if they are moving, detect their speed.

Radar works by transmitting radio pulses, then detecting reflections of these pulses (echoes) from objects in the area and displaying the reflections as targets on your display.

Until you are familiar with interpreting the radar display, every opportunity should be taken to compare the radar screen patterns with visual targets, such as other boats, buoys and coastal structures. You should practise harbor and coastal navigation during daylight hours and in clear weather conditions.

HD and SuperHD radar

Your multifunction display can be used with radar scanners.

HD and SuperHD radar scanners provide a range of advantages, making it easier to discern objects around your vessel.

HD and SuperHD radar scanners provide:

- Improved target detection.
- Full-color image.
- Dual Range operation.
- SuperHD option. This effectively increases the transmitter power by a factor of at least 2, and reduces the beamwidth by a similar amount.

Note: You must connect a SuperHD radar scanner in order to use the SuperHD option.

Multiple radar scanners

The multifunction display only supports the use of 1 radar on the network.

When the radar application is opened, if multiple radar scanners are detected then a warning message shall be displayed. Additional scanners will need to be removed from the network before the radar application will function.

Radar Features

Depending on the type of Raymarine radar you have different features will be available to you, the table below shows which features and settings are supported by radar type:

Feature	Non-HD Digital Radome	HD Radome	HD Open Array	SuperHD Open Array
Color Gain	✗	Auto / Manual (0-100%)	Auto / Manual (0-100%)	Auto / Manual (0-100%)
FTC	Off/On (0-100%)	✗	✗	✗
Sea	Harbour / Coastal / Offshore / Manual (0-100%)	Auto / Manual (0-100%)	Auto / Manual (0-100%)	Auto / Manual (0-100%)
Auto Mode: Buoy	✗	✓	✓	✓
Auto Mode: Harbor	✗	✓	✓	✓
Auto Mode: Offshore	✗	✓	✓	✓
Auto Mode: Coastal	✗	✓	✓	✓
Auto Mode: Bird	✗	✓	✗	✓

Feature	Non-HD Digital Radome	HD Radome	HD Open Array	SuperHD Open Array
Power Boost	✗	✗	✗	✓
Antenna Boost	✗	✗	✗	✓
Interference Rejection	Off / Normal / High	Off / On	Off / On	Off / On
Target Expansion	Off / Low / High	Off / On	Off / On	Off / On
MARPA Targets	10	25	25	25
Dual Range	✗	✓	✓	✓
Dual Range Restrictions	N/A	✗	✗	✗
Scanner Speed	24 RPM	24 RPM / Auto	24 RPM / Auto	24 RPM / Auto
Parking Offset	✗	✗	0-360 degrees	0-360 degrees
Antenna Size	✗	✗	4ft / 6ft	4ft / 6ft
Display Timing	0-153.6m	0-767m (range dependant)	0-767m (range dependant)	0-767m (range dependant)
STC Preset	0-100%	✗	✗	✗
Gain Preset	0-100	✗	✗	✗
Tune Correction	✗	✓	✓	✓

Note: Features not listed are supported by all types of Raymarine Non-HD Digital, HD and SuperHD radars.

13.2 Radar scan speed

SuperHD open array radars with software version 3.23 or above or HD radomes support multiple scan speeds.

Radar scan speed is set up using the Radar Set-up menu. When the system detects a scanner that is capable of operating at both 24 RPM and 48 RPM, 2 options are provided for scanner speed:

- 24 RPM
- Auto

If you have a radar scanner that only operates at 24 RPM, the scanner speed option is disabled. If the scanner speed option is enabled, you must select the Auto option if you want to use the higher scan speeds. This option automatically switches between the 24 RPM and 48 RPM scan speeds as appropriate.

Selecting radar scan speed

The speed option requires a 48 RPM compatible Raymarine HD radome or Raymarine SuperHD open array radar scanner.





Select your radar scanner speed from within the radar application.

1. Select **Menu**.
2. Select **Scanner Set-up**.
3. Select **Scanner Speed**
4. Select the required scanner speed:
 - Auto
 - 24 RPM

The Auto option automatically selects the appropriate speed for your radar range. 48 RPM is used at radar ranges of up to 3 nm. It provides an increased refresh rate, which is useful at high speed or in areas where you have large numbers of radar targets. At radar ranges of greater than 3 nm the display switches the radar speed to 24 RPM.

13.3 Radar scanner status symbols

The radar scanner power mode status is indicated in the databar.

Symbol	Radar power mode	Description
	Transmit (TX)	Rotating icon, signifying that the scanner is on and transmitting. When SCANNER is set to ON, select this mode to activate the scanner. This is the usual mode of operation.
	Standby (STBY)	Static icon, indicating that the scanner is on but not transmitting, and the antenna is not rotating. The scanner does not transmit and the radar data is removed from the screen. This is a power-save mode used when the radar is not needed for short time periods. When you return to transmit mode, the magnetron does not need to warm up again. This is the default mode.
	Off	Scanner powered off when radar not required, but display is in use for other applications, such as the chart. When selected, the system counts down. During this time you cannot re-power the scanner.
 	Timed Transmit	Scanner switches between on/transmitting, and standby mode. Scanner goes into power save mode when constant use of radar is not required.

Powering the radar scanner on and off

In the radar application:

1. Select **Menu**.
2. Select **Power** to switch the Radar's power On and Off.
The radar will always power up in Standby mode.
3. Select **Radar** to switch the radar between Transmit and Standby modes.

Using the power button to switch operating modes

The radar operating modes can also be set using the multifunction displays power button menu.

1. Press and release the **Power** button.
The shortcuts menu is displayed:

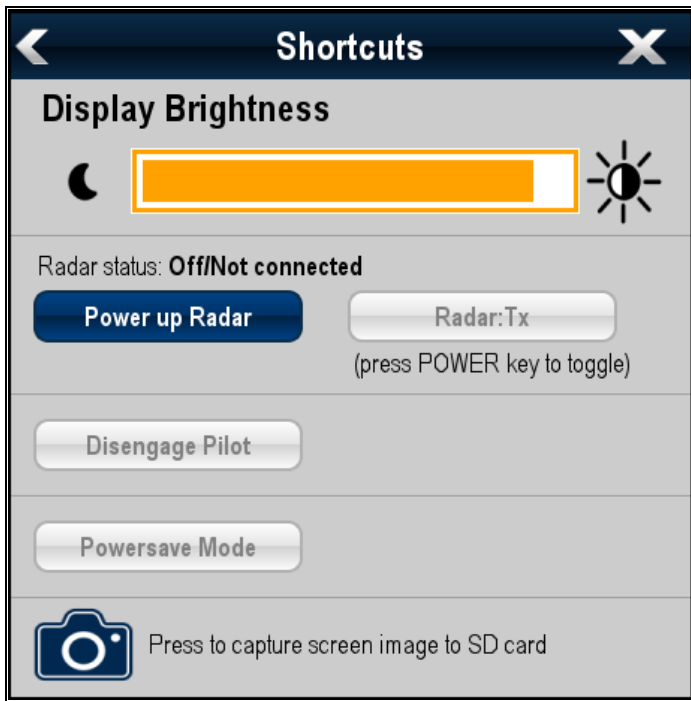

2. Select **Power up Radar** to turn the radar on, or **Power down Radar** to turn the radar off.
3. Select **Radar: Tx** to start the radar transmitting, or **Radar: Stdb** to stop the radar transmitting.

13.4 Radar range and image quality

Maximum radar range

The usable range of the radar is limited by factors such as the height of the scanner, and height of the target.

Maximum radar range is essentially line-of-sight, so is limited by the height of the scanner and the height of the target as illustrated below:

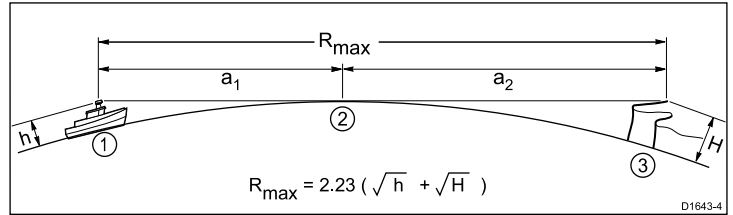

Item	Description
1	Radar equipped vessel.
2	Curvature of the earth.
3	Target (Cliff).
a ₁	Radar horizon of antenna.
a ₂	Radar horizon of target.
R _{max}	Maximum radar range in nautical miles. $R_{max} = a_1 + a_2$
h	Radar antenna height in metres.
H	Target height in metres.

The table below shows typical maximum radar ranges for various radar antenna heights and target heights. Remember that although the radar horizon is greater than the optical horizon, the radar can only detect targets if a large enough target is above the radar horizon.

Antenna height (meters)	Target height (meters)	Maximum range (Nautical miles)
3	3	7.7
3	10	10.9
5	3	8.8
5	10	12

Radar image quality

A number of factors can affect the quality of a radar image, including echoes, sea clutter, and other interference.

Not all radar echoes are produced by valid targets. Spurious or missing echoes may be caused by:

- Side lobes.
- Indirect echoes.
- Multiple echoes.
- Blind sectors.
- Sea, rain, or snow clutter.
- Interference.

Through observation, practice, and experience, you can generally detect these conditions very quickly and use the radar controls to minimize them.

Side Lobes

Side lobe patterns are produced by small amounts of energy from the transmitted pulses that are radiated outside the narrow main beam. The effects of side lobes are most noticeable with targets at short ranges (normally below 3 nm), and in particular with larger objects. Side lobe echoes form either arcs on the radar screen similar to range rings, or a series of echoes forming a broken arc.

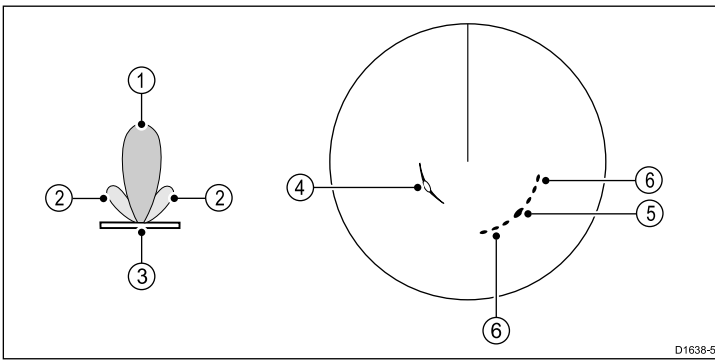

D1638-5

Blind Sectors

Obstructions such as funnels and masts near the radar antenna may obstruct the radar beam and cause radar shadows or 'blind sectors'. If the obstruction is relatively narrow, there will be a reduction of the beam intensity, though not necessarily a complete cut-off. However, for wider obstructions there may be a total loss of signal in the shadow area. There may also be multiple echoes which extend behind the obstruction. Blind sector effects can normally be minimized by careful selection of the scanner site prior to installation.

Rain or Snow Clutter

The radar can see echoes from rain or snow. Returns from storm areas and rain squalls consist of countless small echoes that continuously change size, intensity and position. These returns sometimes appear as large hazy areas, depending on the intensity of the rainfall or snow in the storm cell. The images in the table below show how the Rain control can clear up this clutter:

<p>Rain clutter off</p>	
<p>Rain clutter on</p>	

Sea Clutter

Radar returns from waves around the vessel can clutter the centre of the radar picture, making it difficult to detect real targets. Such 'sea clutter' usually appears as multiple echoes on the display at short range scales, and the echoes are not repetitive or consistent in position. With high winds and extreme conditions, echoes from sea clutter may cause dense background clutter in the shape of an almost solid disc. Sea clutter can be suppressed using the sea clutter settings. The images in the table below show how the sea clutter settings can clear up some of this clutter:

Item	Description
1	Main lobe
2	Side lobes
3	Antenna
4	Arc
5	True echo
6	Side echoes

Indirect Echoes

There are several types of indirect echoes or ghost images. These sometimes have the appearance of true echoes, but in general they are intermittent and poorly defined.

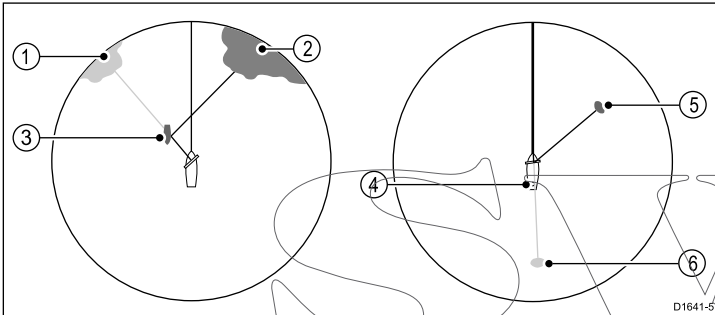

D1641-5

Item	Description
1	False echo
2	True echo
3	Passing ship
4	Mast or funnel
5	True echo
6	False echo

Multiple Echoes

Multiple echoes are not very common but can occur if there is a large target with a wide vertical surface at a comparatively short range. The transmitted signal will be reflected back and forth between the target and your own ship, resulting in multiple echoes, displayed beyond the range of the true target echo, but on the same bearing.

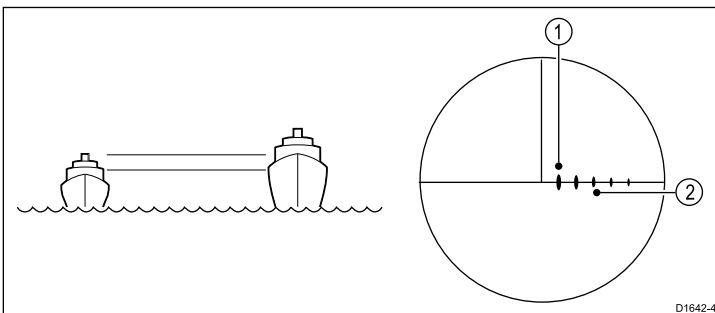

D1642-4

Item	Description
1	True echo
2	Multiple echoes

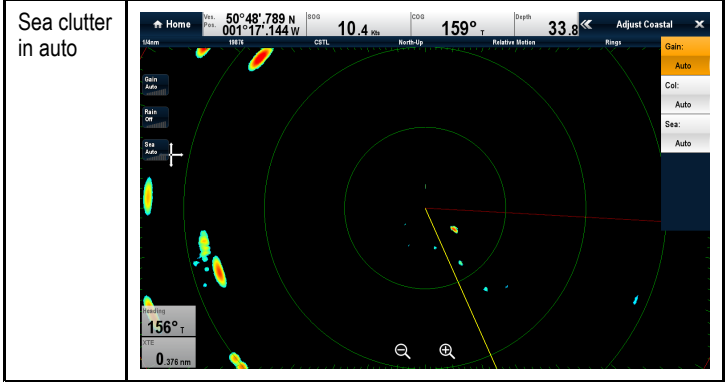
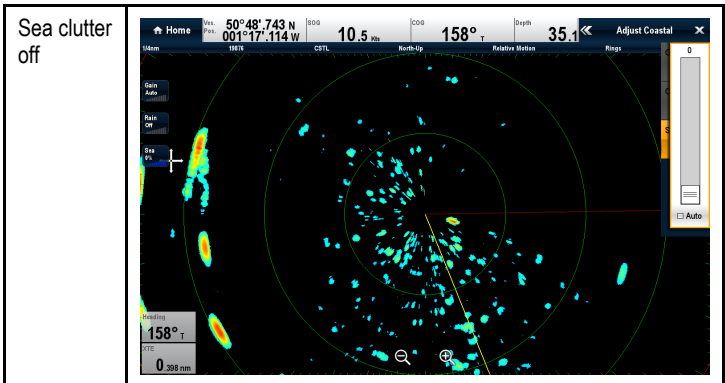

13.5 Radar display overview

With your radar scanner connected and the radar in transmit mode, the radar picture provides a map-like representation of the area in which the radar is operating.

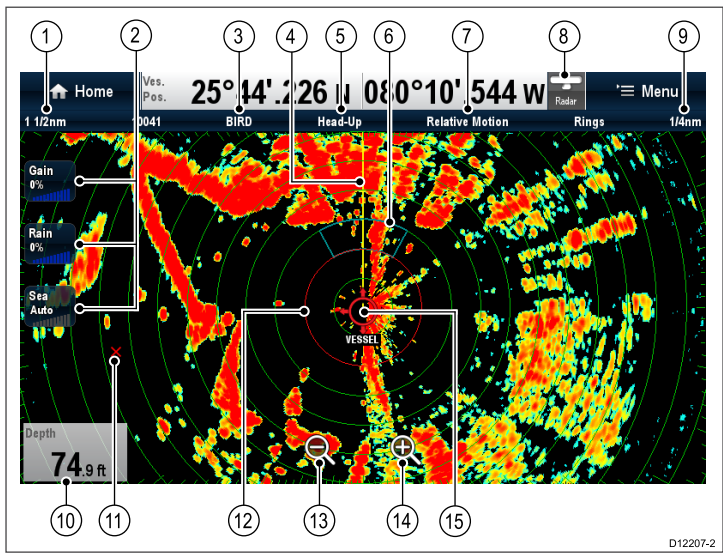

Interference

When two or more radar-equipped vessels are operating within range of each other mutual radar interference can occur. This usually appears as a spiral of small dots from the display centre. This type of interference is most noticeable at long ranges. This interference can be suppressed using the interference rejection settings. The images in the table below show how the Interference rejection settings can clear up some of this interference:

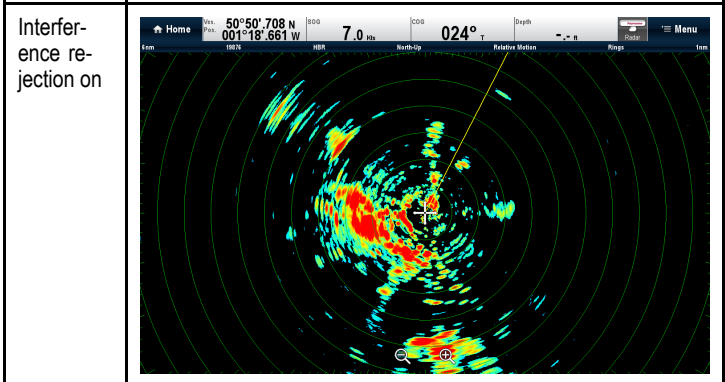
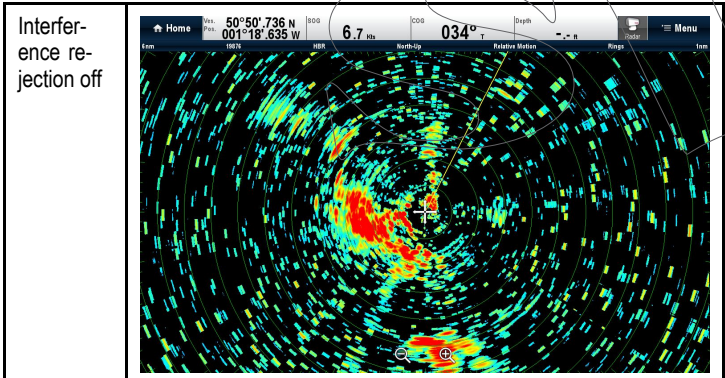

Item	Description
1	Range
2	On-screen controls (Touchscreen multifunction displays only.)
3	Gain mode
4	Ship's Heading Marker (SHM)
5	Orientation
6	Guard Zone
7	Motion mode
8	Range status
9	Range ring spacing
10	Data cell overlay
11	Waypoint
12	Safe zone ring
13	Range out (Touchscreen multifunction displays only.)
14	Range in (Touchscreen multifunction displays only.)
15	Ship's position

Note: On-screen range controls can be enabled and disabled from the homescreen: **Customize > Display Preferences > Range Controls**

Additional functionality of the radar application includes:

- Color palettes.
- Adding AIS overlay.
- MARPA targets.
- VRM/EBL markers

Typically, your vessel's position is at the center of the display, and its dead ahead bearing is indicated by a vertical heading line, known as the Ship's Heading Marker (SHM).

Note: If the cursor is placed over the SHM, the SHM will temporarily be removed to help placing markers or acquiring targets etc.

On-screen targets may be large, small, bright or faint, depending on the size of the object, its orientation and surface. If using a non-HD digital radome scanner, strongest target returns are displayed in yellow with weaker returns in 2 shades of blue. If using a HD or SuperHD radar scanner, stronger target returns show as different colors from a range of 256 colors, providing better clarity. Be aware

that the size of a target on screen is dependent on many factors and may not necessarily be proportional to its physical size. Nearby objects may appear to be the same size as distant larger objects.

Note: Colors stated above refer to the default color palette.

With experience, the approximate size of different objects can be determined by the relative size and brightness of the echoes.

You should bear in mind that the size of each on-screen target is affected by:

- The physical size of the reflecting object.
- The material from which the object is made. Metallic surfaces reflect signals better than non-metallic surfaces.
- Vertical objects such as cliffs reflect signals better than sloping objects such as sandbanks.
- High coastlines and mountainous coastal regions can be observed at longer radar ranges. Therefore, the first sight of land may be a mountain several miles inland from the coastline. Although the coastline may be much nearer, it may not appear on the radar until the vessel is closer to shore.
- Some targets, such as buoys and small vessels difficult to discern, because they do not present a consistent reflecting surface as they bob and toss about in the waves. Consequently these echoes tend to fade and brighten, and at times disappear momentarily.
- Buoys and small vessels resemble each other, but vessels can often be distinguished by their motion.

Note: A GPS receiver and a fast heading sensor are required for MARPA operation, and to enable radar/chart overlay.

Radar context menu

The radar application includes a context menu which provides positional data and menu items.

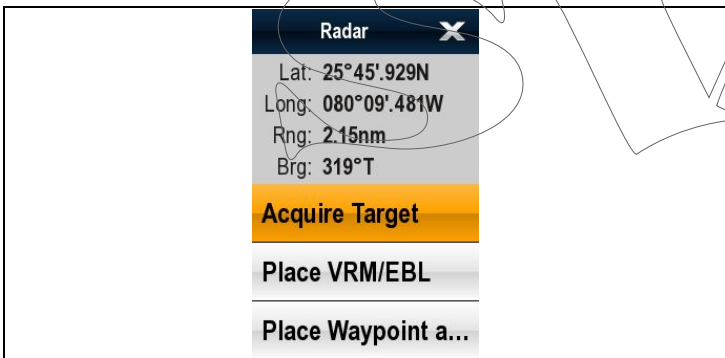

The context menu provides the following positional data for the cursor location in relation to your vessel:

- Latitude
- Longitude
- Range
- Bearing

The context menu also provide the following menu items:

- **Acquire Target**
- **Place VRM/EBL**
- **Place Waypoint At Cursor**
- **Slew thermal camera** (Only available when thermal camera is connected and operating.)

Accessing the context menu

You can access the context menu by following the steps below.

1. New e Series or New c Series:
 - i. Selecting a location, object or target on-screen and pressing the **Ok** button.
2. Touchscreen multifunction displays:
 - i. Selecting an object or target on-screen.
 - ii. Selecting and holding on a location on-screen.

13.6 Dual range radar operation

The Dual Range radar function enables you to view 2 ranges at the same time in separate windows. The function is available with SuperHD and HD radar scanners.

Using your multifunction display and an HD or SuperHD radar scanner, you can view either a short or a long range image in separate radar windows.

The default setting is Long, which provides a standard scanner range.

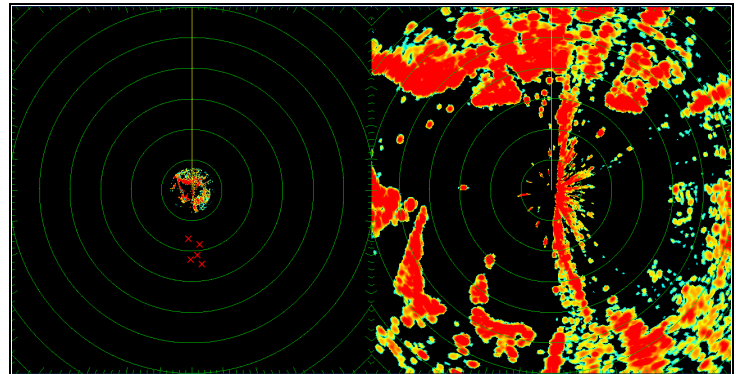

Limitations

- Dual Range operation is not available if MARPA targets are active.
- You cannot acquire MARPA targets if Dual Range is enabled.
- Radar/chart sync and radar/chart overlay are temporarily disabled when Dual Range is enabled.

Dual range radar compatibility

The range covered by the short Dual Range option depends on the radar scanner you are using, and the software version it is using.

Scanner	Dual range mode	*Range covered by software versions 1.xx to 2.xx	Range covered by software versions 3.xx onwards
4 Kw HD Open Array	Long (1)	1/8 nm to 72 nm	1/8 nm to 72 nm
	Short (2)	1/8 nm to 3 nm	1/8 nm to 72 nm
4 Kw SuperHD Open Array	Long (1)	1/8 nm to 72 nm	1/8 nm to 72 nm
	Short (2)	1/8 nm to 3 nm	1/8 nm to 72 nm
12 Kw HD Open Array	Long (1)	n/a	1/8 nm to 72 nm
	Short (2)	n/a	1/8 nm to 72 nm
12 Kw SuperHD Open Array	Long (1)	1/8 nm to 72 nm	1/8 nm to 72 nm
	Short (2)	1/8 nm to 3 nm	1/8 nm to 72 nm
HD Radome	Long (1)	1/8 nm to 48 nm	1/8 nm to 48 nm
	Short (2)	1/8 nm to 48 nm	1/8 nm to 48 nm

Limitations of software version 1.xx and 2.xx

- The value for the short range setting must be less than or equal to the long range setting.
- With **Dual Range** On and a short range window active Expansion control shall be disabled in the **Enhance Echoes** menu.

Using Dual Range with SuperHD scanners

Dual range radar operation with SuperHD scanners.

When using the short Dual Range option, a SuperHD scanner operates in HD mode only. When using the long Dual Range option, a SuperHD radar operates in SuperHD mode.

Scanner	Dual Range mode	Operating mode
4 Kw SuperHD Open Array	Long	SuperHD
	Short	HD
12 Kw SuperHD Open Array	Long	SuperHD
	Short	HD

13.7 Radar mode and orientation

Radar orientation modes

The radar can operate in a number of orientation modes to suit different types of navigation.

The orientation of the radar refers to the relationship between the radar and the direction that you are travelling in. There are three orientation modes to choose from:

- Head-Up
- North-Up
- Course-Up

These orientation modes are used in conjunction with motion mode to control how your boat and radar relate to one another and how they are displayed on screen. Any changes that you make to the orientation of the radar are retained when you switch off your multifunction display.

Head-Up

This is the default mode for the radar application.

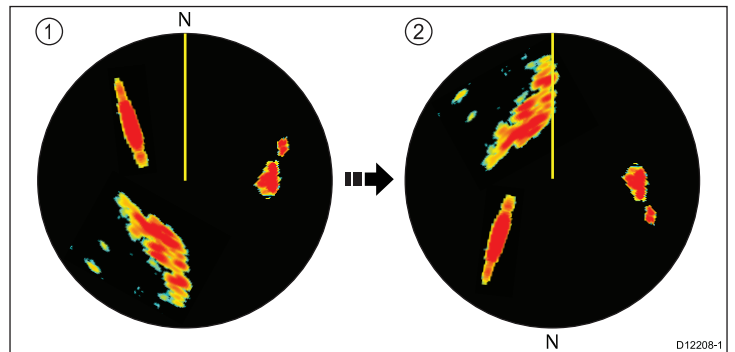

Item	Description
1	Ship's Heading Marker (SHM) (indicating the vessel's current heading is upwards).
2	As the vessel's heading changes: <ul style="list-style-type: none"> • SHM is fixed upwards • Radar picture rotates accordingly

North-Up

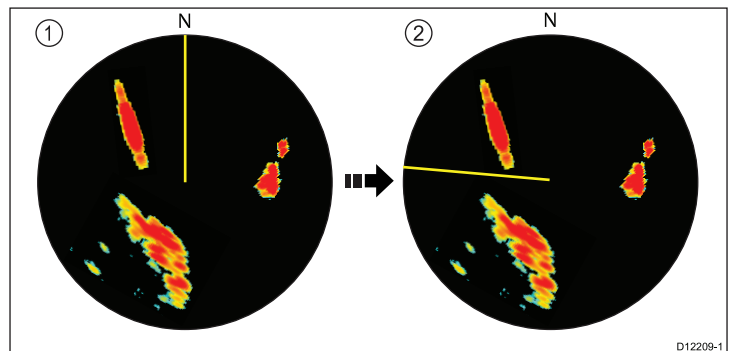

Item	Description
1	True north at top.
2	As your vessel's heading changes: <ul style="list-style-type: none"> • Radar picture is fixed (north up) • SHM rotates accordingly

Note: If heading data becomes unavailable whilst in this mode, a warning message will be shown, the status bar indicates North-Up in brackets and the radar uses 0° heading in relative motion. When heading data becomes available once more, North-Up mode is reinstated.

Note: It is not possible to select Head Up mode when the motion mode is set to True.

Enabling Dual Range radar operation

In the radar application.

1. Select **Menu**.
2. Select **Presentation**.
3. Select **Dual Range** so that On is highlighted.
Selecting Dual Range will switch between dual range On and Off.

Selecting range operation

With Dual Range set to on and the radar application screen displayed:

1. Select **Menu**.
2. Select **Presentation**.
3. Select **Dual Range Channel** to switch between 1 or 2, as appropriate.

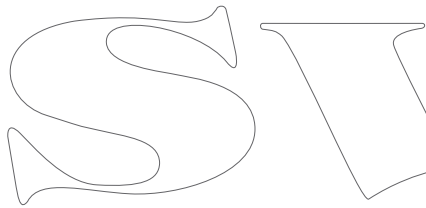

Course-Up

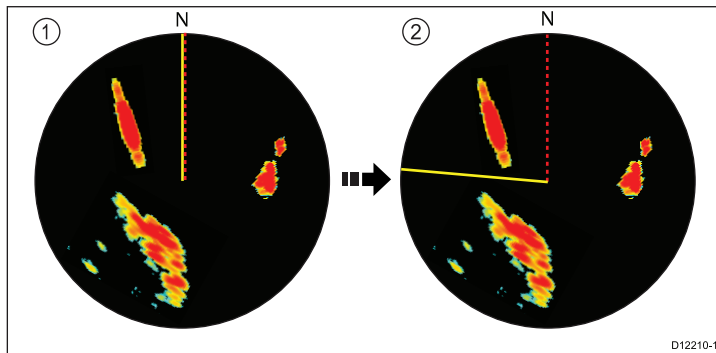

D12210-1

Item	Description
1	Current course upwards.
2	As your vessel's heading changes: <ul style="list-style-type: none"> • Radar picture is fixed • SHM rotates accordingly

If you select a new course, the picture will reset to display the new course upwards.

The reference used for Course-Up depends upon the information available at a given time. The system always prioritizes this information in the following order:

1. Bearing from origin to destination, that is, intended course.
2. Locked heading from an Autopilot.
3. Bearing to waypoint.
4. Instantaneous heading (when course-up is selected).

Note: If heading data becomes unavailable whilst in this mode, a warning message will be shown, the status bar indicates the Course Up in brackets and the radar uses 0° heading in relative motion. When heading data becomes available once more, Course-Up mode is reinstated.

Selecting the radar orientation mode

From the radar application:

1. Select **Menu**.
2. Select **Presentation**.
3. Select **Orientation & Motion Mode**.
4. Select **Orientation**.
5. Select the required orientation.

Radar motion modes overview

The motion mode controls the relationship between the radar and your vessel. There are two modes:

- Relative motion.
- True motion.

The selected motion mode is displayed in the status bar. The default setting is Relative Motion with zero offset.

Relative Motion (RM) with optional Vessel Offset

When the motion mode is set to Relative, the position of your vessel is fixed on the screen and all the targets move relative to the vessel. You can specify whether the vessel is fixed in the center of the window (0 offset) or offset by 1/3 or 2/3 to increase the view ahead, as shown below:

Examples:

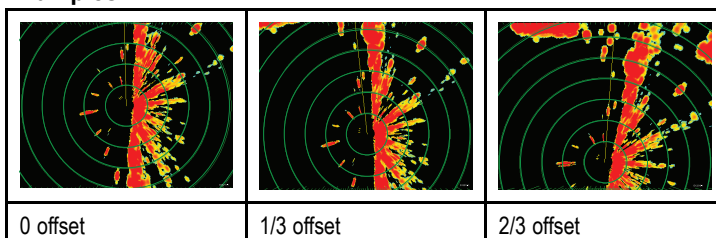

The default motion mode is “Relative”, with zero offset.

True Motion (TM)

When the motion mode is set to True, fixed radar targets maintain a constant position and moving vessels (including your vessel) travel in true perspective to each other and to fixed landmasses on the screen. As the vessel's position approaches the edge of the screen, the radar picture is automatically reset to reveal the area ahead.

Note: If heading and position data become unavailable when True motion is selected, a warning message will be shown, the mode will revert to relative motion and be noted in the status bar in brackets, for example, (TM).

Note: It is not possible to select True Motion when the orientation is set to Head Up.

Selecting the radar motion mode

From the radar application:

1. Select **Menu**.
2. Select **Presentation**.
3. Select **Orientation & Motion Mode**.
4. Select **Motion Mode**.

Selecting Motion Mode will switch between True and Relative.

Changing the radar vessel offset

Radar offset is only available in Relative motion mode.

From the radar application:

1. Select **Menu**.
2. Select **Presentation**.
3. Select **Orientation & Motion Mode**.
4. Select **Vessel Offset**.
5. Select the required offset value.

13.8 Radar tuning: On-screen gain controls

Touchscreen multifunction displays provide on-screen access to controls for Gain, Rain and Sea clutter.

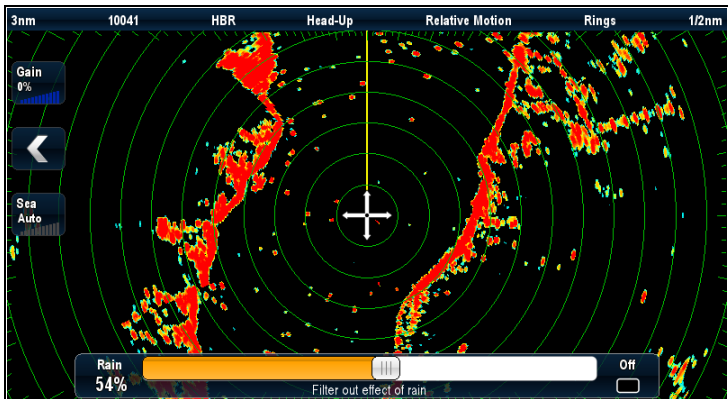

Gain control

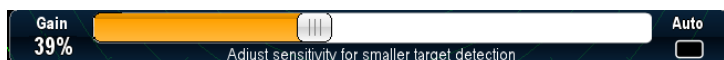

Rain control

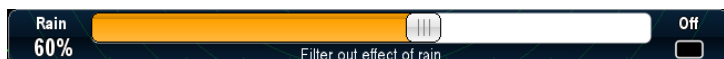

Sea control



Note: non-touchscreen controls are accessed by the menu options: **Menu > Rain** and **Menu > Adjust Gain**.

Enabling and disabling on-screen gain controls

You can enable and disable the on-screen gain controls by following the steps below.

On a touchscreen multifunction display, with the relevant application displayed.

1. Select **Menu**.
2. Select **Presentation**.
3. Select **Gain Controls**.
Select Gain Controls will switch between showing and hiding the on-screen controls.

Using the on-screen gain controls

To adjust settings using the on-screen controls follow the steps below.

On a touchscreen multifunction display, with the radar application displayed:

1. Select either the **Gain**, **Rain** or **Sea** on-screen icon.
The on-screen slider bar control is displayed.
2. Select the **Auto** box (Gain and Sea) or **Off** box (Rain) so that a tick is **placed** in the box to switch to automatic control or switch the control off, or
3. Select the **Auto** box (Gain and Sea) or **Off** box (Rain) so that a tick is **removed** placed in the box to switch to manual control.
4. Adjust the slider bar to the required setting.
5. The slider bar will auto dismiss, or you can select the on-screen icon again to close the slider bar.

13.9 Radar adjustments: HD and SuperHD scanners

You can use the gain presets and other functions to improve the quality of the radar picture.

The following settings are available from the Radar menu and apply to HD radomes, HD and SuperHD open array scanners:

Menu Item	Description	Options
Auto Gain Mode	The radar gain presets enable you to quickly select pre-configured settings to achieve the best picture in different situations. Raymarine strongly recommends the use of these presets to achieve optimum results.	<ul style="list-style-type: none"> • Buoy — a special mode that enhances the detection of small objects like mooring buoys. It is useful at ranges up to 0.75 nm. • Harbor — this is the default mode. This setting takes account of land clutter so that smaller targets, like navigation buoys, are not lost. • Coastal — accounts for the slightly higher levels of sea clutter you might encounter out of harbor and adjusts the radar display accordingly. • Offshore — automatically adjusts for high levels of sea clutter. • Bird Mode — a special mode that helps you to identify flocks of birds, useful when identifying suitable fishing locations, for example. <div style="border: 1px solid black; padding: 5px; margin-top: 10px;"> <p>Note: Bird Mode requires a SuperHD open array with software version 3.23 or above or an HD radome.</p> </div>
Rain	The radar scanner detects echoes from rain or snow. These echoes appear on screen as countless small echoes continuously changing size, intensity and position. Turning the rain clutter function On suppresses the bulk effect of rain returns from around your vessel, making it easier to recognize other objects. You can adjust the intensity of this setting between 0 and 100%.	<ul style="list-style-type: none"> • On — enables the Rain function and allows you to adjust the setting between 0 and 100%. • Off — disables the Rain function. This is the default.
Adjust Gain	Each of the gain presets can be manually adjusted using gain, color gain and sea clutter functions.	<ul style="list-style-type: none"> • Gain — enables you to use a preset in automatic mode, or to adjust its gain manually between 0 and 100%. • Color Gain— adjusts the intensity (color) of displayed targets, but does not affect the number of targets displayed. Increasing the color gain causes more targets to be displayed in the same color, which may help you to determine whether an object is an actual target, or just background noise. Reducing the color gain may provide better target detail and detection. • Sea — radar echoes from waves around your vessel can clutter the center of the radar picture, making it difficult to detect real targets. Adjusting the sea gain reduces this clutter for up to 5 nautical miles (depending on wave and sea conditions) from your vessel. • SuperHD Controls — for SuperHD scanners only: <ul style="list-style-type: none"> – Antenna Boost: scales the effective antenna size. At zero, the effective antenna size matches its actual size. At 95%, the effective antenna size is doubled. Increasing the effective antenna size separates targets that appear merged at lower settings. – Power Boost: adjusts effective transmit power. At zero, the radar operates at its standard power (4 kW or 12 kW). At 90, the effective power is increased by a factor of at least two. Increasing the power makes targets more distinct from noise. For maximum benefit, reduce power boost to prevent saturation of strong targets.

Selecting radar gain presets

These presets require a HD or SuperHD radar scanner. Bird mode requires a SuperHD open array scanner with software version 3.23 or above or an HD radome.

From the radar application:

1. Select **Menu**.
2. Select **Auto Gain Mode**.
3. Select Buoy, Harbor, Coastal, Offshore, or Bird as appropriate.

The option is ticked and the display changes to reflect the new mode.

Adjusting radar preset gain

Raymarine strongly recommends the use of the preset gain modes to achieve optimum results. However if required manual adjustments can be made.

From the radar application, with the required **Auto Gain Mode** selected:

1. Select **Menu**.
2. Select **Adjust Gain <Mode>**, where <Mode> shall be the Auto Gain mode already selected.

3. Select **Gain**.
4. The Gain slider bar control is displayed.
5. Adjust the Gain slider bar control to the appropriate setting (between 0 and 100%), or
6. Select the **Auto** box so that a tick is placed in the box for automatic gain control.

Adjusting radar color gain

From the radar application, with the required **Auto Gain Mode** selected:

1. Select **Menu**.
2. Select **Adjust Gain <Mode>**, where <Mode> shall be the Auto Gain mode already selected.
3. Select **Col**.
4. The Color Gain slider bar control is displayed.
5. Adjust the Color Gain slider bar control to the appropriate setting (between 0 and 100%), or
6. Select the **Auto** box so that a tick is placed in the box for automatic gain control.

Adjusting radar anti sea clutter

From the radar application, with the required **Auto Gain Mode** selected:

1. Select **Menu**.
2. Select **Adjust Gain <Mode>**, where <Mode> shall be the Auto Gain mode already selected.
3. Select **Sea:** .
4. The Sea clutter slider bar control is displayed.
5. Adjust the Sea clutter slider bar control to the appropriate setting (between 0 and 100%), or
6. Select the **Auto** box so that a tick is placed in the box for automatic sea clutter control.

Adjusting radar anti rain clutter

From the radar application:

1. Select **Menu**.
2. Select **Rain**.
The Rain clutter slider bar control is displayed.
3. Adjust the Rain clutter slider bar control to the appropriate setting (between 0% and 100%), or
4. Select the **Off** box so that a tick is placed in the box to turn off anti rain clutter control.

Adjusting SuperHD radar antenna boost

From the radar application:

1. Select **Menu**.
2. Select **Adjust Gain <Mode>**, where <Mode> shall be the Auto Gain mode already selected.
3. Select **Antenna**.
The Antenna Boost slider bar control is displayed.
4. Adjust the Antenna Boost slider bar control to the appropriate setting (between 0 and 100%), or
5. Select the **Auto** box so that a tick is placed in the box for automatic boost control.

Adjusting SuperHD radar power boost

From the radar application:

1. Select **Menu**.
2. Select **Adjust Gain <Mode>**, where <Mode> shall be the Auto Gain mode already selected.
3. Select **Power**.
The Power Boost slider bar control is displayed.
4. Adjust the Power Boost slider bar control to the appropriate setting (between 0 and 100%), or
5. Select the **Auto** box so that a tick is placed in the box for automatic boost control.

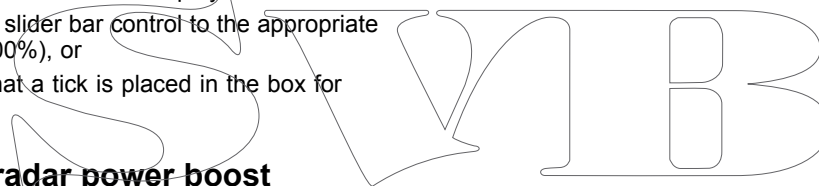

13.10 Radar adjustments: non-HD digital radomes

You can use the gain presets and other functions to improve the quality of the radar picture.

The following settings apply to non-HD digital radomes and are available from the Radar menu:

Menu Item	Description	Options
Rain	The radar scanner detects echoes from rain or snow. These echoes appear on screen as countless small echoes continuously changing size, intensity and position. Turning the rain clutter function On suppresses the bulk effect of rain returns from around your vessel, making it easier to recognize other objects. You can adjust the intensity of this setting between 0 and 100%.	<ul style="list-style-type: none"> • On — enables the Rain function and allows you to adjust the setting between 0 and 100%. • Off — disables the Rain function. This is the default.
Adjust Gain	<p>Enables you to adjust the sensitivity of the radar reception. In some situations, adjusting the sensitivity may improve the clarity of the radar picture. The following settings are available:</p> <ul style="list-style-type: none"> • Gain • FTC — Enables you to remove areas of clutter at a distance from your vessel. It also helps you to distinguish between two very close echoes on the same bearing, which may otherwise merge and appear as one echo. You can adjust the intensity of the FTC function between 0 and 100%: <ul style="list-style-type: none"> – A higher setting shows only the leading edge of large (rain clutter) echoes, while the effect on smaller (ship) echoes is only slight. – A lower setting reduces background noise and fill-in returns from land and other large targets. • Sea — Enable you to quickly select pre-configured settings to achieve the best picture in different situations. Each of the gain presets has a gain function, which is set to automatic mode by default. Raymarine strongly recommends the use of these presets to achieve optimum results. However, you can adjust this gain manually if required. • Auto Sea Mode 	<p>Gain</p> <ul style="list-style-type: none"> • Auto — the preset operates in automatic mode. This is the default. • Man — allows you to manually adjust the intensity of the gain, from 0 to 100%. <p>FTC</p> <ul style="list-style-type: none"> • On — enables the FTC function and allows you to adjust the setting between 0 and 100%. • Off — disables the FTC function. This is the default. <p>Sea</p> <ul style="list-style-type: none"> • Auto— the preset operates in automatic mode. This is the default. • Man— allows you to manually adjust the intensity of the sea gain, from 0 to 100%. <p>Auto Sea Mode</p> <ul style="list-style-type: none"> • Harbor — this is the default mode. This setting takes account of land clutter so that smaller targets, like navigation buoys, are not lost. • Coastal — accounts for the slightly higher levels of sea clutter you might encounter out of harbor and adjusts the radar display accordingly. • Offshore — Automatically adjusts for high levels of sea clutter.

Adjusting radar anti rain clutter

From the radar application:

1. Select **Menu**.
2. Select **Rain**.
The Rain clutter slider bar control is displayed.
3. Adjust the Rain clutter slider bar control to the appropriate setting (between 0% and 100%), or
4. Select the **Off** box so that a tick is placed in the box to turn off anti rain clutter control.

1. Select **Menu**.
2. Select **Adjust Gain <Mode>**, where <Mode> shall be the Auto Gain mode already selected.
3. Select **Sea**.
4. The Sea clutter slider bar control is displayed.
5. Adjust the Sea clutter slider bar control to the appropriate setting (between 0 and 100%), or
6. Select the **Auto** box so that a tick is placed in the box for automatic sea clutter control.

Adjusting the radar FTC function

From the radar application:

1. Select **Menu**.
2. Select **Adjust Gain <Mode>**, where <Mode> shall be the Auto Gain mode already selected.
3. Select **FTC**.
The FTC slider bar control is displayed.
4. Adjust the FTC slider bar control to the appropriate setting (between 0 and 100%), or
5. Select the **Auto** box so that a tick is placed in the box for automatic FTC control.

Selecting radar auto gain mode

These presets require a digital radar scanner.

From the radar application:

1. Select **Menu**.
2. Select **Gain Mode**.
3. Select Harbor, Coastal or Offshore as appropriate.

The option is ticked and the display changes to reflect the new mode.

Adjusting radar anti sea clutter

From the radar application, with the required **Auto Gain Mode** selected:

13.11 Radar presentation menu options

Function	Description	Options
Dual Range	This menu item allows you to turn Dual range mode On and Off.	<ul style="list-style-type: none"> • On • Off
Dual Range Channel	This menu item allows you to choose long or short channel for dual range.	<ul style="list-style-type: none"> • 1 • 2
Orientation & Motion Mode	<p>This menu item contains a sub-menu which enables you to adjust the orientation and motion mode:</p> <ul style="list-style-type: none"> • Orientation • Motion Mode • Vessel Offset 	<p>Orientation</p> <ul style="list-style-type: none"> • Head Up • North Up • Course Up <p>Motion Mode</p> <ul style="list-style-type: none"> • True • Relative <p>Vessel Offset</p> <ul style="list-style-type: none"> • 0 • 1/3 • 2/3
Enhance Echoes	<p>This menu item contains a sub-menu which enable you to adjust the follow options:</p> <ul style="list-style-type: none"> • Interference Rejection • IR Level — only available on non-HD digital radomes. • Expansion • Expansion Level — only available on non-HD digital radomes. • Wakes • Wakes Period 	<p>Interference Rejection</p> <ul style="list-style-type: none"> • On • Off <p>IR Level — only available on non-HD digital radomes.</p> <ul style="list-style-type: none"> • Normal • High <p>Expansion</p> <ul style="list-style-type: none"> • On • Off <p>Expansion Level — only available on non-HD digital radomes.</p> <ul style="list-style-type: none"> • Low • High <p>Wakes</p> <ul style="list-style-type: none"> • On • Off <p>Wakes Time Period</p> <ul style="list-style-type: none"> • 10 Secs • 30 Secs • 1 Min • 5 Min • 10 Min
Select Waypoints to Display	This menu item takes you to the Display Waypoints dialog where you can choose which waypoint icons to Show/Hide in the radar application.	<p>Display Waypoint</p> <ul style="list-style-type: none"> • Show • Hide
Waypoint Name	This menu item allows you to show or hide waypoint names in the radar application.	<ul style="list-style-type: none"> • Show • Hide

Function	Description	Options
Data Overlay Set-up	This menu item contains a sub-menu which enables you to turn on and select information to display in data cells located on the bottom left of the radar application (Data cells will be displayed in all radar windows). <ul style="list-style-type: none"> • Data Cell 1 • Select Data Category • Data Cell 2 • Select Data Category 	Data Cell 1 & 2 <ul style="list-style-type: none"> • On • Off Select Data Category <ul style="list-style-type: none"> • List of available data by category
Color Palette	This menu item allows you to select a Color Palette for the radar application.	<ul style="list-style-type: none"> • Bold • Professional 1 • Professional 2 • Classic • Night Vision
Range Rings	This menu item allows you to turn the range rings On and Off.	<ul style="list-style-type: none"> • On • Off
Safe Zone Ring	This item allows you to show or hid the safe zone ring in the radar application.	<ul style="list-style-type: none"> • Show • Hide

Enhance echoes functions

Enabling radar interference rejection

From the radar application:

1. Select **Menu**.
2. Select **Presentation**.
3. Select **Enhance Echoes**.
4. Select **Interference Rejection** so that On is highlighted.
Selecting Interference Rejection will switch the function between On and Off.
5. For non-HD digital radomes you can also select an interference rejection level:
 - i. Select **IR Level**.
Selecting IR Level will switch between Normal and High.

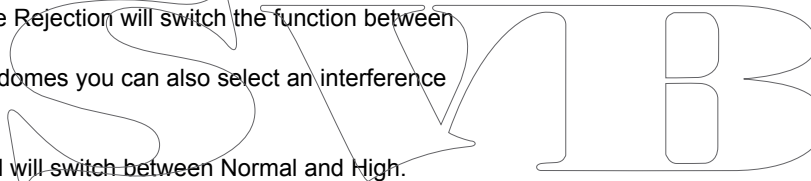

Enabling radar expansion

From the radar application:

1. Select **Menu**.
2. Select **Presentation**.
3. Select **Enhance Echoes**.
4. Select **Expansion** so that On is highlighted.
Selecting expansion will switch the function between On and Off.
5. For non-HD digital radomes you can also select an interference rejection level
 - i. Select **Expansion Level**.
Selecting Expansion Level will switch between Low and High.

Enabling radar wakes

From the radar application:

1. Select **Menu**.
2. Select **Presentation**.
3. Select **Enhance Echoes**.
4. Select **Wakes** so that On is highlighted.
Selecting Wakes will switch the function between On and Off.
5. Select **Wakes time period**.
A list of wake time periods is displayed:
 - 10 sec
 - 30 sec
 - 1 min
 - 5 min
 - 10 min
6. Select the required time period.

13.12 Using radar to measure distances, ranges, and bearings

When you are using the radar application, you can measure distances, ranges and bearings in a variety of ways.

These options are detailed in the table below:

Functions	Distances Between Points	Range From Your Vessel	Bearings
Range Rings	Yes (approximate distance)	Yes (approximate range)	No
Cursor	No	Yes	Yes
Variable Range Markers / Electronic Bearing Lines (VRM/EBL)	No	Yes	Yes
Floating VRM/EBL	Yes	No	Yes

Measuring using the range rings

Use the range rings to gauge the approximate distances between points. Range rings are concentric circles displayed on the screen and centred from your vessel at pre-set distances. The number and spacing of the rings changes as you range in and out.

Examples:

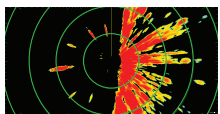
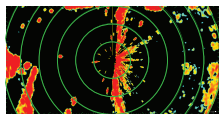
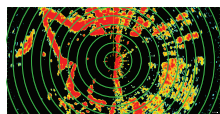
		
Range — 1/4 nm Range Rings — 760ft apart	Range — 3/4 nm Range Rings — 1/4 nm apart	Range — 1 1/2 nm Range Rings — 1/4 nm apart

Measuring using the cursor

To measure the bearing and range from your vessel to a specified target, move the cursor to the appropriate position on the screen and press **Ok**, the radar context menu will be displayed which shall provide:

- Latitude
- Longitude
- Range
- Bearing

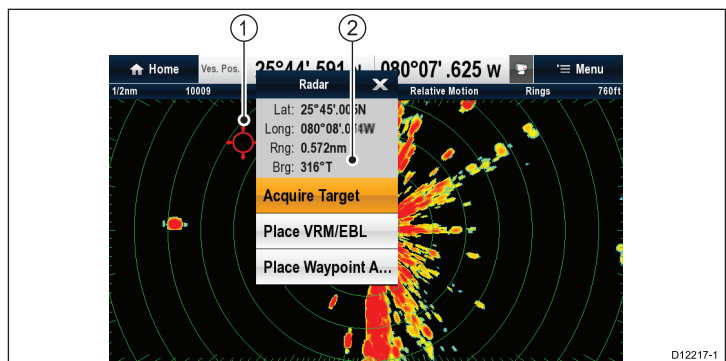

Item	Description
1.	Cursor
2.	Bearing and range from your vessel to the cursor position

You can also display the cursor position in the databar, from the homescreen select: **Customize > Databar Set-up > Edit Databar**, now select the data box where you want the cursor position to be displayed. Select **Navigation > Cursor Position**.

Measuring using VRM/EBL Variable Range Markers (VRM)

A Variable Range Marker (VRM) is a circle centred on your vessel's position and fixed with respect to the heading mode. When this circle is adjusted to align with a target, its range from your vessel is measured and displayed on the Radar context menu when you select the VRM with the cursor.

Electronic Bearing Lines (EBL)

An Electronic Bearing Line (EBL) is a line drawn from your vessel to the edge of the window. When this line is rotated to align with a target, its bearing relative to your vessel's heading is measured and displayed on the Radar context menu when you select the VRM with the cursor.

The VRM/EBL are combined to measure both the range and the bearing of the specified target.

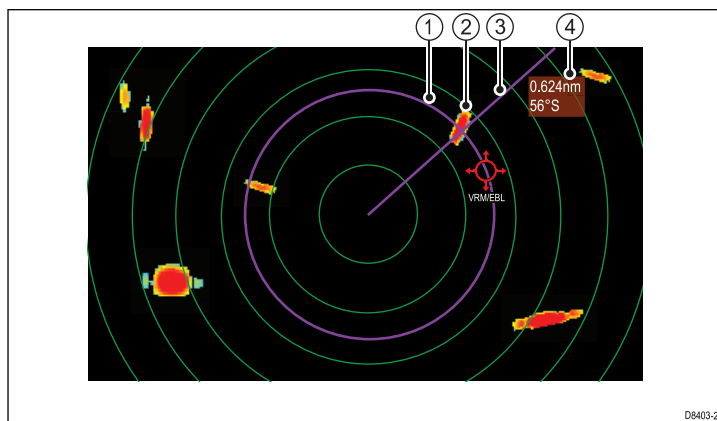

Item	Description
1	VRM
2	Target
3	EBL
4	Range and bearing

Measuring using floating VRM/EBL

You can use the VRM/EBL float function to measure the range and bearing between any two points on the radar screen. This function allows you to move the VRM/EBL centre away from your vessel's position and onto a target. You can then change the radius of the VRM to determine the distance between two points and change the angle of the EBL, relative to its new origin, to obtain the bearing.

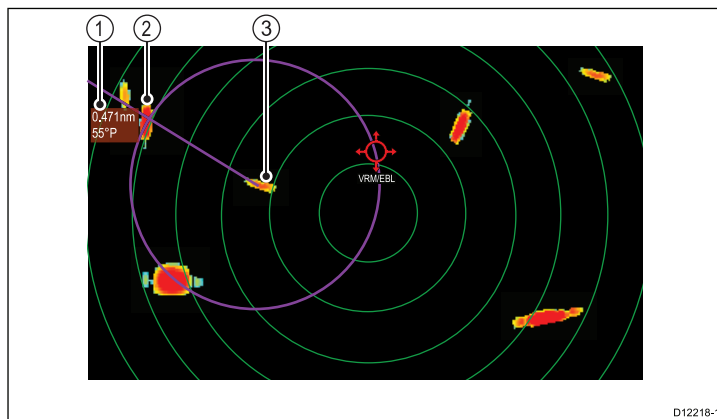

Item	Description
1	Range and bearing
2	Target 1
3	Target 2

VRM/EBL context menu

The VRM/EBL function includes a context menu which provides positional data and menu items.

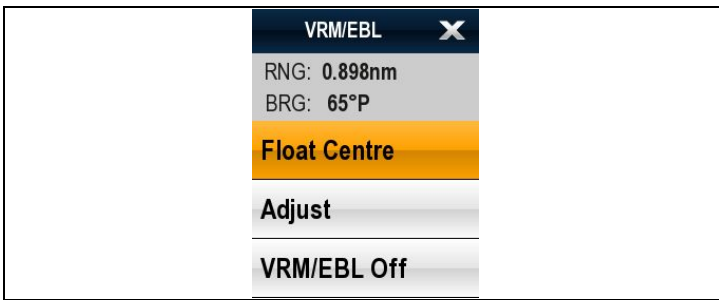

The context menu provides positional data of the VRM/EBL in relation to your vessel:

- Range
- Bearing

The context menu also provide the following menu items:

- **Float Centre**
- **Adjust**
- **VRM/EBL Off**

Accessing the context menu

You can access the context menu by following the steps below.

1. New e Series or New c Series:
 - i. Selecting a location or the relevant object on-screen and pressing the **Ok** button.
2. Touchscreen multifunction displays:
 - i. Selecting and holding on a location or relevant object on-screen.



Creating a VRM/EBL on the radar display

To create a VRM/EBL on a touchscreen multifunction display follow the steps below:

From the radar application:

1. Select and hold on the screen.
The radar context menu is displayed.
2. Select **Place VRM/EBL**.
3. Select the required location / target.
The VRM/EBL is now set at the selected location.



Creating a VRM/EBL on the radar display

From the radar application:

1. Select a target or location on screen.
2. Press the **Ok** button.
The radar context menu is displayed.
3. Select **Place VRM/EBL**.
4. Using the **Joystick** adjust the VRM/EBL to the required bearing and range.
5. Press the **Ok** button to save the setting.



Creating a floating VRM/EBL on the radar display

To float a VRM/EBL on a touchscreen multifunction display follow the steps below:

From the radar application with a VRM/EBL already created:

1. Press and hold on the VRM/EBL.
The VRM/EBL context menu is displayed.
2. Select **Float Center**.
3. Select the desired location for the center position.
The VRM/EBL is placed at the new location.



Creating a floating VRM/EBL on the radar display

From the radar application with a VRM/EBL already created:

1. Position the cursor over the VRM/EBL.
2. Press the **Ok** button.
The radar context menu is displayed.
3. Use the **Rotary Control** to select **Float Center**.
4. Press the **Ok** button.
5. Using the **Joystick**, move the center position of the circle to the desired position.
6. Press the **Ok** button to confirm the new position.



Unfloating a VRM/EBL on the radar display

To re-center a VRM/EBL on a touchscreen multifunction display follow the steps below:

From the radar application:

1. Position the cursor over the VRM/EBL.
The Radar context menu is displayed.
2. Select **Center**.



Unfloating a VRM/EBL on the radar display

From the radar application:

1. Position the cursor over the VRM/EBL.
2. Press the **Ok** button.
The VRM/EBL context menu is displayed.
3. Select **Center**.

Using the radar range rings

Radar range rings enable you to measure the distance between two points on the radar display.

Use the range rings to gauge the approximate distances between points. Range rings are concentric circles displayed on the screen and centred from your vessel at pre-set distances. The number and spacing of the rings changes as you range in and out.

Examples:

Range — 1/4 nm Range Rings — 760ft apart	Range — 3/4 nm Range Rings — 1/4 nm apart	Range — 1 1/2 nm Range Rings — 1/4 nm apart

Enabling and disabling radar range rings

From the radar application:

1. Select **MENU**.
2. Select **Presentation**.
3. Select **Range Rings**.
Selecting Range rings will switch the range rings On and Off.

13.13 Using radar to track targets and avoid collisions

The **Guard Zone**, **VRM/EBL** and **MARPA** functions will help you track targets and avoid collisions.

With a radar connected to your multifunction display, you can:

- Assess how far away a target is and its bearing (VRM/EBL).
- Set an alarm to trigger when a target is within a specified zone (Guard Zone).
- Display detailed information on tracked targets (MARPA).
- Display the range and bearing of a target.

Setting up a radar guard zone

From the radar application:

1. Select **Menu**.
2. Select **Track Targets**.
3. Select **Guard Zone Set-up**.
4. Select **Zone** so that On is highlighted.
Selecting Zone will switch the zone On and Off.
5. Select **Adjust Zone**.
6. Select **Shape**: to switch between Sector or Circle.
7. Select **Outer**: .
The Outer numeric adjust control is displayed.
8. Adjust the outer edge of the guard zone to the required distance.
9. Select **Ok** to close the numeric adjust control.
10. Select **Inner**: .
The Inner numeric adjust control is displayed.
11. Adjust the inner edge of the guard zone to the required distance.
12. Select **Ok** to close the numeric adjust control.
13. Select **Width**: .
The Width numeric adjust control is displayed.
14. Adjust the width of the guard zone in degrees.
15. Select **Ok** to close the numeric adjust control.
16. Select **Bearing**: .
The Bearing numeric adjust control is displayed.
17. Adjust the bearing of the guard zone in degrees port or degrees starboard.
18. Select **Ok** to close the numeric adjust control.

Note: Guard zone width and bearing can only be adjusted when the **Shape**: is set to Sector.

Guard zone context menu

The guard zone function includes a context menu which provides additional menu items.

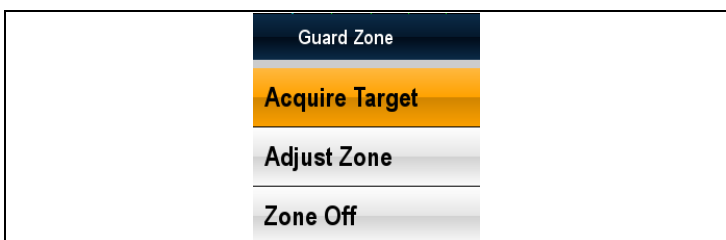

The context menu provides the following menu items:

- **Acquire Target**.
- **Adjust Zone**
- **Zone Off**

Accessing the context menu

You can access the context menu by following the steps below.

1. New e Series or New c Series:
 - i. Selecting a location, object or target on-screen and pressing the **Ok** button.
2. Touchscreen multifunction displays:
 - i. Selecting an object or target on-screen.
 - ii. Selecting and holding on a location on-screen.

Adjusting guard zone sensitivity

You can adjust the threshold at which the alarm is triggered by a target entering the guard zone.

1. Select **Menu**.
2. Select **Track Targets**.
3. Select **Guard Zone Set-up**.
4. Select **Sensitivity**.
The sensitivity numeric adjust control is displayed.
5. Adjust the sensitivity to the required value.
6. Select **Ok** to confirm setting and close the numeric adjust control.

The guard zone sensitivity setting can also be accessed from the **Alarms** menu: **homescreen > Set-up > Alarms > Guard Zone > Sensitivity**.

MARPA overview

MARPA is used for target tracking and risk analysis in the radar application.

With an accurate heading sensor connected to your multifunction display, you can use the Mini Automatic Radar Plotting Aid (MARPA) functions for target tracking and risk analysis. MARPA improves collision avoidance by calculating information for tracked targets, and provides continuous, accurate, and rapid situation evaluation. The number of targets that you can track at any one time is dependent on the model of radar scanner that you are using.

MARPA tracks acquired targets, and calculates the target's speed and course.

Each target tracked can be displayed with a graphic indicating the Closest Point of Approach (CPA), and Time to Closest Point of Approach (TCPA). The calculated target data can also be shown on your screen. Each target is continually assessed and an audible alarm is sounded if a target becomes dangerous, or is lost.

For effective MARPA operation, your multifunction display must have accurate heading and speed data for your vessel. The better the quality of the heading and speed data, the better MARPA will perform. For the best heading data, a Raymarine SMART heading sensor or a gyro-stabilized autopilot is required.

In True Motion mode, Speed Over Ground (SOG) and Course Over Ground (COG) information is required to show true target course and speed.

In Relative Motion mode, heading and speed information is required.

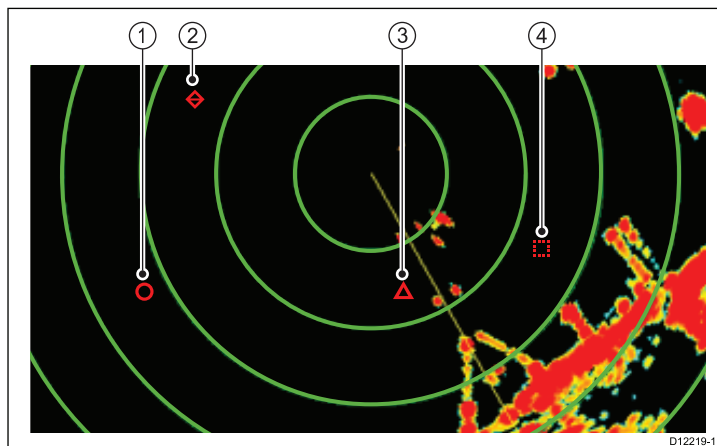

Item	Description
1	Safe target
2	Lost target
3	Dangerous target
4	Target being acquired

Safety notices

MARPA can improve collision avoidance when used wisely. It is your responsibility to exercise common prudence and navigational judgement.

There are conditions where acquiring a target may become difficult. These same conditions may be a factor in successfully tracking a target. Some of the conditions are:

- The target echo is weak. The target is very close to land, buoys or other large targets.
- The target or your own vessel is making rapid manoeuvres.
- Choppy sea state conditions exist and the target is buried in excessive sea clutter or in deep swells.
- Choppy sea state conditions exist yielding poor stability; own vessel's heading data is very unstable.
- Inadequate heading data.

Symptoms of such conditions include:

- target acquisition is difficult and the MARPA vectors are unstable;
- the symbol wanders away from the target, locks-on to another target, or changes to a lost symbol target.

In these circumstances, target acquisition and tracking may need to be re-initiated and in some cases might be impossible to maintain. Better quality heading data might improve performance in these circumstances.

How a MARPA risk is assessed

Each target is monitored to ascertain whether it will be within a certain distance from your vessel within a certain time. If so, the target is designated as dangerous, and an audible warning is sounded and a warning displayed. The target symbol changes to the dangerous target symbol and flashes to indicate that it is a dangerous target. Acknowledging the alarm will remove the warning.

If a target is lost, either because the MARPA software has lost contact with it, or because it has moved out of range, an audible alarm is sounded and an on-screen warning appears. The on-screen symbol will change to the target lost symbol. Acknowledging the warning will silence the alarm and remove the on-screen warning and the target lost symbol.

Effective range for MARPA targets

MARPA target acquisition is only available at radar range scales of up to 12 nm, although tracking continues at all ranges.

If you change to a smaller range scale, targets may be beyond the range of your radar scanner and will be lost. In such cases, an on-screen warning indicates that the target is off-screen.

MARPA context menu

The MARPA function includes a context menu which provides positional data and menu items.



The context menu provides the following target information:

- CPA
- TCPA
- COG
- SOG

The context menu also provide the following menu items:

- **Cancel target**
- **CPA Graphic**
- **MARPA Data**
- **Slew thermal camera** (Only available when thermal camera is connected and operating.)

Accessing the context menu

You can access the context menu by following the steps below.

1. New e Series or New c Series:

- i. Selecting a location, object or target on-screen and pressing the **Ok** button.
2. Touchscreen multifunction displays:
 - i. Selecting an object or target on-screen.
 - ii. Selecting and holding on a location on-screen.

Configuring MARPA options

From the radar application:

1. Select **Menu**.
2. Select **Track Targets**.
3. Select **MARPA Options**.

Note: If AIS data is available the menu will be **MARPA & AIS Options**.

4. Select **Vector Length**.
5. Select an appropriate time period.
The distance that your vessel travels in the time period you specify here determines the length of the vector lines.
6. Select **MARPA Target History**.
7. Select an appropriate time period.
The target's previous position will be plotted on the radar display as a target icon with lighter shading than the actual target.

Note: MARPA and AIS functions share **Safe Zone** and **Vector Length** settings.

Configuring safe zone set up for MARPA

From the Radar application:

1. Select **Menu**.
2. Select **Track Targets**.
3. Select **Safe Zone Set-up**.
4. Select **Safe Zone Radius**.
 - i. Select a distance for the Safe Zone.
This is the distance from your vessel that the safe zone will be set up.
5. Select **Time to Safe Zone**.
 - i. Select a time period.
A target is considered dangerous if it will enter your safe zone within this time period.
6. Select **Safe Zone Ring**.
Selecting safe zone ring will switch between showing and hiding the safe zone ring in the radar application.

Using MARPA

Acquiring a MARPA target to track

From the radar application:

1. Select the target to be acquired.
The MARPA context menu is displayed.
2. Select **Acquire Target**.

The "target being acquired" symbol is displayed. If the target is present for several scans, the radar locks-on to the target, and the symbol changes to "safe target" status.

Cancelling a MARPA target using the MARPA context menu

From the radar application:

1. Select the relevant target.
The MARPA context menu is displayed.
2. Select **Cancel Target** or **Cancel All Targets**.

Cancelling a MARPA target using the menu

1. Select **Menu**.
2. Select **Track Targets**.
3. Select **View MARPA Lists**.

Note: If AIS data is available the menu will be **View MARPA & AIS Lists**.

4. Select View **MARPA List**.
5. Select the relevant MARPA target from the list.
6. Select **Cancel Target** or **Cancel All Targets**.

Vessel vectors (CPA graphics) overview

CPA graphics show vectors for your vessel and a selected target.

A vector is a line on-screen showing the predicted courses of your vessel and the selected target if you both remain on your present course. These vectors vary in length due to vessel speed and vector length set in the MARPA Set-up menu.

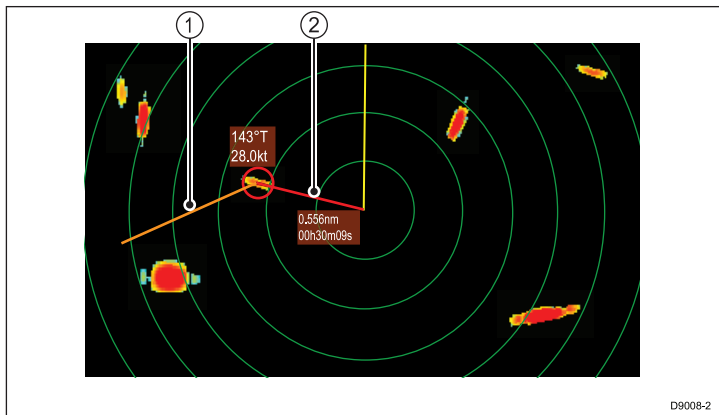

D9008-2

Item	Description
1	Target vector
2	CPA graphic

True motion

With the display set in true motion mode, the vectors of your vessel and the target are shown extended to their intersection point. The CPA is shown as a line that is placed on your vessel's vector at the point of the CPA. The length and direction of the line indicates the distance and bearing of the target at CPA. The text indicates CPA and TCPA. The text next to the target symbol indicates its true course and speed.

Relative motion

With the display set in relative motion mode, no vector extension of your vessel is shown. The CPA line emerges from your own vessel, with the target vector extension being shown as relative, not true. The text next to the target indicates its course and speed.

Displaying MARPA target data

- Select the target.
 - The MARPA context menu is displayed which provides the following data:
 - Closest Point of Approach (CPA).
 - Time to Closest Point of Approach (TCPA).
 - COG (if available).
 - SOG (if available).
- To display CPA graphics select **CPA Graphic** from the context menu:
 - Select **Auto** to display the CPA graphic when the target is selected.
 - Select **On** to display the CPA graphic while the target is being tracked.
 - Select **Off** to hide the CPA graphic.
- To display course and bearing information alongside to the target select **MARPA Data** so that Show is highlighted.
 - Selecting MARPA Data will switch between Show and Hide.

Viewing full MARPA target information

From the radar application:

- Select **Menu**.
- Select **Track Targets**.
- Select **View MARPA Lists**.
- Select **View MARPA List**.
- Select the relevant target.
- Select **View Full Target Data**.

13.14 Scanner set-up menu options

The Scanner Set-up menu enables you to configure the performance and behavior of your radar scanner.

Function	Description	Options
Timed Transmit Set-up	This menu item contains a sub-menu that enables you to adjust the timed transmit options: <ul style="list-style-type: none"> • Timed Transmit • Transmit Period • Standby Period 	Timed Transmit <ul style="list-style-type: none"> • On • Off Transmit Period <ul style="list-style-type: none"> • 10 Scans • 20 Scans • 30 Scans Standby Period <ul style="list-style-type: none"> • 3 minutes • 5 minutes • 10 minutes • 15 minutes
Tune Adjust	This menu item allows you to fine tune the radar scanner's receiver for maximum returns on the display. Raymarine recommends that this function is set to Auto. If you set this function to Manual and adjust the setting shortly after powering up the radar scanner, you should adjust it again approximately 10 minutes after powering up the scanner, as the required setting will change after the magnetron has warmed up.	Man <ul style="list-style-type: none"> • Auto • Man 0% — 100%
EBL Reference	The measurement point used for reference when measuring distances using Electronic Bearing Lines (EBLs) and range rings in the chart application. The options are Relative to ships heading or referenced to the compass is degrees Magnetic — True as selected in Bearing Mode.	<ul style="list-style-type: none"> • Relative • Mag-True
Sea Clutter Curve	This menu item allows you to adjust the Sea Clutter — radar echoes from waves can make it difficult to detect real targets. These echoes are known as "sea clutter". Several factors can affect the level of clutter you see, including the weather and sea conditions, and the mounting height of the radar. The sea clutter curve setting adjusts the radar's sensitivity to sea clutter. The steepest setting for the curve is 1, and the most shallow setting is 8.	<ul style="list-style-type: none"> • Adjust Curve (1 to 8)
Scanner Speed	SuperHD open array radars with software version 3.23 or above or HD radomes support multiple scan speeds: <ul style="list-style-type: none"> • 24 RPM • 48 RPM 	Scanner Speed <ul style="list-style-type: none"> • 24 RPM • Auto — this option automatically switches between the 24 RPM and 48 RPM scan speeds as appropriate.
Advanced Set-up	This menu item contains a sub-menu that enables you to adjust the following options: <ul style="list-style-type: none"> • Bearing Alignment • Display Timing • Main Bang Suppression • Tune Preset • STC Preset— Non-HD Digital radomes only • Reset Advanced 	Bearing Alignment <ul style="list-style-type: none"> • -180° — 179.5° Display Timing <ul style="list-style-type: none"> • 0.415 n m — selected range Main Bang Suppression <ul style="list-style-type: none"> • On • Off Tune Preset <ul style="list-style-type: none"> • 0 — 255 STC Preset <ul style="list-style-type: none"> • 0 — 100% Reset Advanced <ul style="list-style-type: none"> • Yes • No

Adjusting the radar tune control

From the radar application:

1. Select **Menu**.
2. Select **Scanner Set-up**.
3. Select **Tune Adjust**.
4. Select **Tune Adjust**: .
The Tune Adjust slider bar control is displayed.
5. Adjust the slider bar control to the appropriate setting, or
6. Select the **Auto** box so that a tick is placed in the box for automatic tuning.

13.15 Resetting the radar

To reset radar settings to defaults follow the steps below:

From in the radar application:

1. Select **Menu**.
2. Select **Scanner Set-up**.
3. Select **Advanced Set-up**.
4. Select **Reset Advanced**.

A confirmation pop up message is displayed.

5. Select **Yes** to confirm reset.

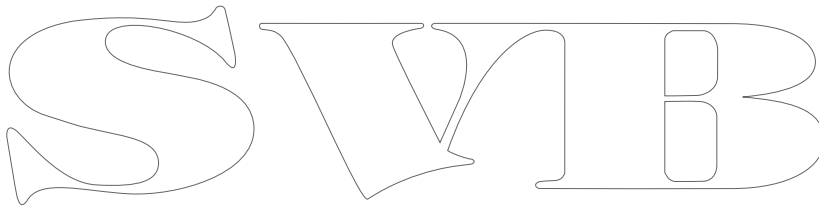

Chapter 14: Using AIS

Chapter contents

- [14.1 AIS overview on page 162](#)
- [14.2 AIS prerequisites on page 163](#)
- [14.3 AIS context menu on page 163](#)
- [14.4 Enabling AIS on page 164](#)
- [14.5 Displaying AIS vectors on page 164](#)
- [14.6 AIS status symbols on page 165](#)
- [14.7 AIS silent mode on page 165](#)
- [14.8 AIS target symbols on page 166](#)
- [14.9 Displaying detailed AIS target information on page 166](#)
- [14.10 Viewing all AIS targets on page 167](#)
- [14.11 Using AIS to avoid collisions on page 167](#)
- [14.12 AIS options on page 168](#)
- [14.13 AIS alarms on page 169](#)
- [14.14 Buddy tracking on page 169](#)

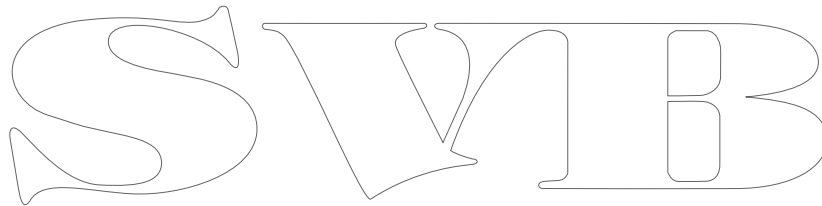

14.1 AIS overview

The AIS feature enables you to receive information broadcast by other vessels, and to add these vessels as targets in the chart and radar applications.

With an optional AIS unit connected to your system you can:

- Display targets for any other AIS-equipped vessels.
- Display voyage information being broadcast by these targets, such as their position, course, speed and rate-of-turn.
- Display basic or detailed information for each target vessel, including safety-critical target data.
- Set up a safe zone around your vessel.
- View AIS alarm and safety-related messages.
- Add AIS-equipped friends and regular contacts to a "Buddy List"

AIS information is displayed in the form of an overlay in the chart and radar applications. Additional data is displayed in a dialog box, for example:

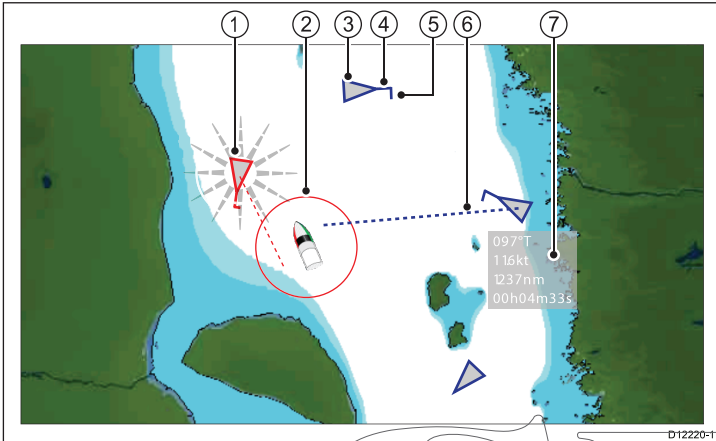

Item	Description
1	Dangerous target (flashes).
2	Safe zone (defined by distance and / or time).
3	AIS target vessel.
4	Heading.
5	Direction of turn.
6	COG/SOG vector.
7	Safety critical data.

AIS-equipped vessels in the surrounding area are displayed in the chart or radar application as triangular targets. Up to 100 targets are displayed. As the vessel's status changes, the symbol for the target changes accordingly.

Vectors can be displayed for each target. These vectors indicate the vessel's direction of travel and the distance it will travel over a specified period of time (COG / SOG vector). Targets displayed with their vectors are referred to as 'active targets' and are scaled according to the size of the vessel. The larger the vessel, the larger the target. You can either display all targets or just dangerous targets.

How AIS Works

AIS uses digital radio signals to broadcast 'real-time' information between vessels and shore-based stations via dedicated VHF radio frequencies. This information is used to identify and track vessels in the surrounding area and to provide fast, automatic and accurate collision avoidance data. The AIS features complement the radar application, as AIS can operate in radar blind spots and can detect smaller vessels equipped with AIS.

Note: It may not be mandatory for vessels to be fitted with operational AIS equipment. Therefore, you should not assume that your multifunction display will show ALL vessels in your area. Due prudence and judgement should be exercised. AIS should be used to complement radar, NOT substitute it.

AIS Simulator Mode

Raymarine recommends that you use the simulator function to familiarize yourself with the AIS features. When the simulator function is enabled (**homescreen > Set-up > System Settings > Simulator**), it displays 20 AIS targets within a 25 nm range. These targets are displayed using the appropriate AIS target's status symbol, and move around the screen as if they were real targets.

Note: Incoming safety messages are NOT displayed while the simulator is enabled.

14.2 AIS prerequisites

You must have suitable AIS hardware connected to your multifunction display to make use of the AIS functionality.

In order to run AIS, you will need:

- A receive-only AIS unit or a full AIS transceiver (a unit that sends and receives).
- A VHF antenna.
- A GPS - to provide position data.
- The AIS layer enabled in the chart or radar application, as appropriate.

Note: A receiver will allow you to receive data about other vessels in your area but will not allow other vessels to 'see' you. A full transceiver transmits and receives AIS data, and therefore allows you to receive data about other vessels. It also enables other AIS-equipped vessels to see and receive information about your vessel. This could include position, course, speed and rate of turn data.

When the AIS unit is connected to your multifunction display, the status of the unit is indicated by an AIS icon in the status bar.

You can connect an AIS unit to your multifunction display using NMEA0183 or SeaTalk^{ng}, depending on the AIS unit. If connecting using NMEA0183, you will now need to specify the 38,400 baud setting (**homescreen > Set-up > System Settings > NMEA Set-up**) for the NMEA input port that communicates with the AIS transceiver or receiver.

14.3 AIS context menu

The AIS function includes a context menu which provides AIS target information and menu items.

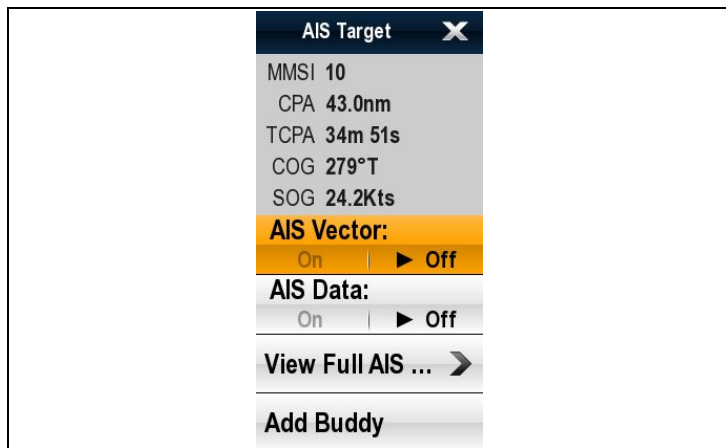

The context menu provides the following AIS target data:

- MMSI
- CPA
- TCPA
- COG
- SOG

The context menu also provide the following menu items:

- **AIS Vector** — Switch target vectors On and Off.
- **AIS Data** — Switch on screen target data On and Off.
- **View Full Data**
- **Add Buddy** — Add target to the buddy directory.
- **Acquire Target** (only available if Radar overlay is switched on.)
- **Slew thermal camera** (only available when thermal camera is connected and operating.)

Accessing the context menu

You can access the context menu by following the steps below.

1. New e Series or New c Series:
 - i. Selecting a location, object or target on-screen and pressing the **Ok** button.
2. Touchscreen multifunction displays:
 - i. Selecting an object or target on-screen.
 - ii. Selecting and holding on a location on-screen.

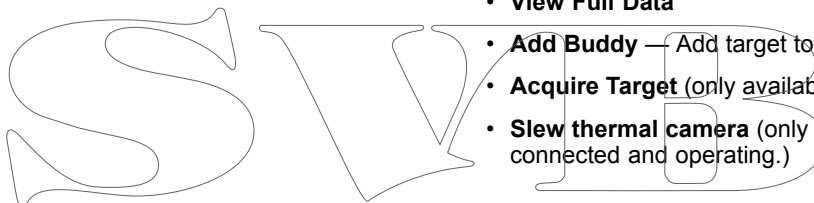

14.4 Enabling AIS

Enabling AIS in the chart application

To enable AIS overlay in the chart application the chart view must be set to 2D **Menu > Presentation > Chart View**.

From the chart application:

1. Select **Menu**.
2. Select **Presentation**.
3. Select **Layers**.
4. Select **AIS**: so that On is highlighted.
Selecting AIS will switch AIS between On and Off.

Enabling AIS in the radar application

From the radar application:

1. Select **Menu**.
2. Select **Track Targets**.
3. Select **AIS Targets** so that On is highlighted.
Selecting AIS Targets will switch AIS between On and Off.

14.5 Displaying AIS vectors

You must have the correct data available before AIS vectors can be displayed.

A target is defined as active when it has the following data displayed graphically:

- A COG/SOG vector indicating the predicted distance that a target will travel within a given period of time.
- A heading and direction of turn indicator.

Enabling and disabling AIS vectors

From the chart or radar application:







1. Select an AIS target.
The AIS target context menu is displayed.
2. Select **AIS Vector**.
Selecting AIS Vector will switch between On and Off.

Note: The same target vector and safe zone settings apply to both radar MARPA and AIS targets.

The image shows the letters 'S V I B' in a large, stylized, outlined font. The letters are white with a black outline and are set against a plain white background. The 'S' is on the left, followed by 'V', 'I', and 'B' on the right. The font is a decorative, serif style.

14.6 AIS status symbols

AIS status is indicated by a symbol in the databar.

Symbol	Description
	AIS unit is switched on and operating.
	AIS currently unavailable.
	AIS unit is switched off, or not connected.
	AIS unit is in Silent Mode.
	AIS unit is in Silent Mode, with active alarms.
	AIS unit is connected and switched on, but has active alarms.
	AIS unit is connected and switched on, but the dangerous and lost alarm is disabled.

14.7 AIS silent mode

AIS silent mode enables you to disable AIS transmissions

AIS silent mode enables you to disable the transmitting functions of your AIS equipment. This is useful when you do not want to transmit your vessel's AIS data to other AIS receivers, but still wish to receive data from other vessels.

Note: Not all AIS equipment supports silent mode. For more information, refer to the documentation that accompanies your AIS unit.

Enabling and disabling AIS silent mode in the chart application

From the chart application:

1. Select **Menu**.
2. Select **AIS Options**.
3. Select **AIS Unit Set-up**.
4. Select **AIS Silent Mode**.

Selecting AIS Silent Mode will switch between silent mode On and Off.

Enabling and disabling AIS Silent Mode in the radar application

From the Radar application:













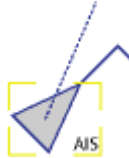
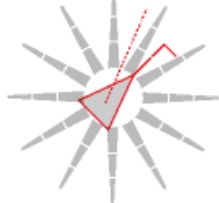

1. Select **Menu**.
2. Select **Track Targets**.
3. Select **AIS Unit Set-up**.
4. Select **AIS Silent Mode**.

Selecting AIS Silent Mode will switch silent mode On and Off.

S V I B

14.8 AIS target symbols

Your multifunction display shows a range of symbols to represent the different types of AIS target.

Target type	Description	Symbol
Transmitting target	Target is moving or at anchor (Target is not activated, dangerous or lost).	
Activated target	Target activated — that is, AIS vector displayed. Vector line (optional) shows predicted distance travelled within a given time.	
Selected target	Target selected with cursor. Can view detailed data.	
Dangerous target	Targets within specified distance (CPA) or time (TCPA). Dangerous target alarm sounds if enabled. Target red and flashing.	
Uncertain target	Calculated CPA / TCPA value uncertain.	
Lost target	When the signal of a dangerous target not received for 20 seconds. Target in latest predicted position. Alarms sounds if enabled. Target flashes.	
Buddy target	Target has previously been added to the Buddy List.	
Aid To Navigation (AToN) target (Real)	AToN target is ON position.	
Aid To Navigation (AToN) target (Real)	AToN target is OFF position.	
Aid To Navigation (AToN) target (Virtual)	AToN target is ON position.	
Aid To Navigation (AToN) target (Virtual)	AToN target is OFF position.	
Land base station target	Land base station target is ONLINE.	
Search and rescue transponders (SARTS) target	SARTS target	
Search and rescue aircraft (SARS) target	SARS target	
Military and law enforcement target	Only displayed when connected to approved STEDS-EAIS AIS hardware.	

14.9 Displaying detailed AIS target information

From the chart or radar application:

1. Select an AIS target.
The AIS target context menu is displayed.
2. Select **View Full AIS Data**.

AIS Data

The table below shows the AIS target information which if available will be displayed on the multifunction display:

- Type
- Status
- Destination
- Last Seen
- ETA
- MMSI
- Call Sign
- IMO No.
- Length
- Beam
- Draught
- Heading
- ROT
- Position
- COG
- SOG
- CPA
- TCPA

Note: Available data is dependant upon what information is being transmitted from the target vessel and the type of AIS unit connected to your system.

14.10 Viewing all AIS targets

From the chart application go to **Menu > AIS Options**

From the radar application go to **Menu > Track Targets > View AIS Lists**

1. Select **AIS List**.

A list of all available AIS targets is displayed. The list will provide the following data:

- MMSI
- Range
- Bearing
- Buddy
- Type

This list can be filtered to show only buddies or all targets.

2. To view full AIS target information Select an AIS target from the list and then select **View Full Target Data**.

The AIS target info dialog is displayed showing all available data on the target.

14.11 Using AIS to avoid collisions

You can use the AIS safe zone and safety message functions to help you avoid collisions with other vessels and objects.

Safe Zones

A safe zone is a ring centred on your vessel within which a target is considered dangerous. It is displayed in the radar or chart applications as a red ring.

This AIS safe zone uses the same criteria as MARPA and will deem a target dangerous if it comes within a specified distance of your vessel (closest point of approach or CPA) within a specified time (time to closest point of approach or TCPA). The CPA and TCPA are calculated using COG/SOG and position from the AIS target.

When your system recognizes a dangerous AIS target:

- The target symbol changes to red and flashes.
- The dangerous alarm dialog is displayed (this can be disabled if required).
- The dangerous alarm sounds (this can be disabled if required).

Note: When the AIS unit is connected and functioning, the system will check for dangerous targets within the safe zone and if enabled issue an alarm whenever necessary. Dangerous target alarm operates irrespective of the status of the AIS target display, or the safe zone ring.

Safety Messages

When the status of the AIS Safety Messages function is set to On, any incoming safety messages from surrounding vessels, shore stations and mobile stations are displayed in a dialog box. If known, the message will include the sending vessel's position in latitude / longitude. You will have the option to:

- Remove the message (**Ok**).
- Place a waypoint on your chart / radar to mark the sending vessel's position (**Place Waypoint**).
- Goto the sending vessel's position (**Goto Waypoint**).

Note: You will **NOT** receive any safety messages in Simulator mode (**homescreen > Set-up > System Settings > Simulator**).

Enabling Safe Zones

To show the Safe Zone ring follow the instructions below:

From the chart application go to **Menu > AIS Options > Safe Zone Set-up**

From the radar application go to **Menu > Track Targets > Safe Zone Set-up**

1. Select **Safe Zone Ring** so that **Show** is highlighted.
Selecting Safe Zone Ring will switch the zone ring from hidden to visible.
2. Select **Safe Zone Radius**.
 - i. Select the required radius for the safe zone.
3. Select **Time to Safe Zone**.
 - i. Select the required time period.
4. Select **AIS Alarm** so that **On** is highlighted.
Selecting AIS Alarm will switch the dangerous target alarm between On and Off.

Enabling and disabling AIS safety messages in the chart application

From in the chart application:

1. Select **Menu**.
2. Select **AIS Options**.
3. Select **AIS Unit Set-up**.
4. Select **AIS Safety Messages**.
Selecting AIS Safety Messages will switch between safety messages On and Off.

Enabling and disabling AIS safety messages in the radar application

From in the radar application:

1. Select **Menu**.

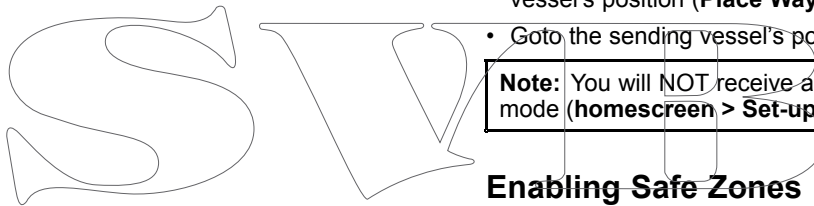

2. Select **Track Targets**.
3. Select **AIS Unit Set-up**.
4. Select **AIS Safety Messages**.

Selecting AIS Safety Messages will switch between safety messages On and Off.

Displaying safety-critical AIS information

From the chart or radar application:

1. Select the AIS target.
The AIS target context menu is displayed.
2. Select **AIS Data** so that On is highlighted.
Selecting AIS Data will switch between AIS data On and Off.

The Safety critical AIS data will now be displayed next to the target in the application.

14.12 AIS options

The AIS options are accessible in the chart application by selecting **Menu > AIS Options > MARPA & AIS Options** or the radar application by selecting **Menu > Track Targets > MARPA & AIS Options**.

Parameter	Description	Options
Vector Length	The length of the vector lines displayed depends on the distance that an AIS target travels in the time period that you specify for this setting.	<ul style="list-style-type: none"> • 0.5 min • 1 min • 3 min • 6 min • 12 min • 30 min • 60 min
Display AIS	This option determines whether all or only dangerous / lost targets are displayed in the radar or chart application.	<ul style="list-style-type: none"> • All • Dangerous
Buddy Tracking	This option allows you to turn the Buddy Tracking function On and Off.	<ul style="list-style-type: none"> • On • Off
Add New Buddy Vessel	This option allows you to add a buddy to the directory by manually entering the vessel MMSI number.	
AIS Unit Set-up	Provides the following options: <ul style="list-style-type: none"> • AIS Silent Mode — Switches silent mode On or Off. AIS silent mode enables you to disable AIS transmissions. • Safety Messages — Allows you to enable or disable the display of AIS safety messages. • View AIS Unit Log — Displays a list of AIS alarms, and includes details on when the alarm was raised and a description of the fault. 	<ul style="list-style-type: none"> • AIS Silent Mode <ul style="list-style-type: none"> • Off (default) • On • Safety Messages <ul style="list-style-type: none"> • On (default) • Off • View AIS Unit Log <ul style="list-style-type: none"> • Display Alarms list.

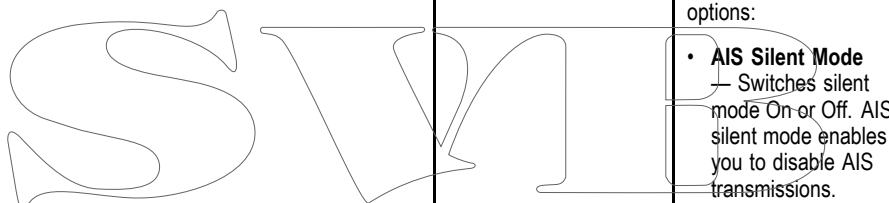

14.13 AIS alarms

The AIS functions generate a number of alarms to alert you to dangerous or lost targets.

In addition to the dangerous target alarm, the system generates an alarm when a dangerous target becomes a lost target i.e. its signal has not been received for 20 seconds.

Your AIS receiver generates local alarms which are displayed and sounded on your multifunction display whenever an alarm condition exists on the unit.

Local AIS alarms

When the connected AIS unit generates an alarm, your multifunction display shows a local alarm message and indicates the alarm status in the status bar.

Active AIS alarms list

The active alarm list shows the status of each local alarm. This list can be accessed from the chart application by going to **Menu > AIS Options > AIS Unit Set-up > View AIS Unit Log**, or from the radar applications by going to **Menu > Track Targets > AIS Unit Set-up > View AIS Unit Log**.

Acknowledging AIS alarms

In the chart or radar application:

1. Select **Ok** on the alarm dialog box.

Note: An AIS alarm remains active until it is acknowledged on your multifunction display.

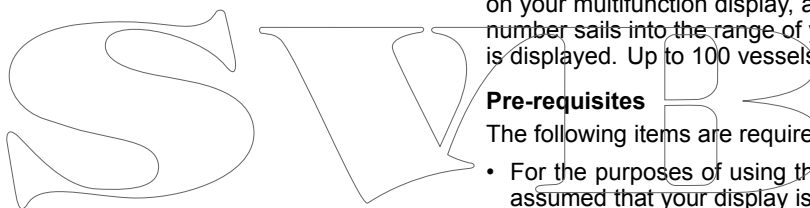

14.14 Buddy tracking

The Buddy Tracking feature enables you to add AIS-equipped friends and regular contacts to a "Buddy List" on your multifunction display. As soon as a vessel on your Buddy List sails into the range of your AIS unit, the vessel icon changes to indicate this.

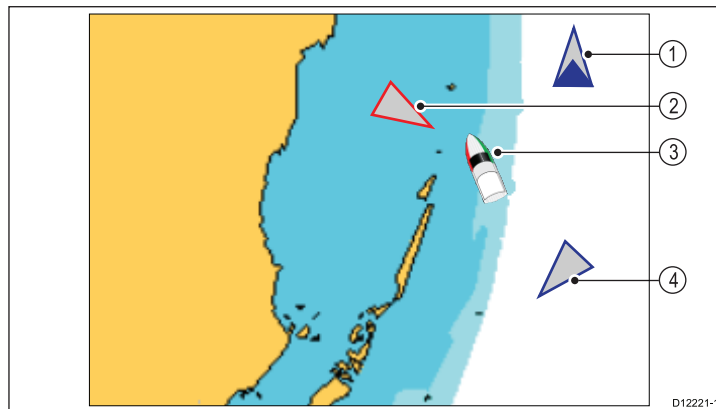

Item	Description
1	Buddy icon
2	Dangerous target icon
3	Own vessel icon
4	Normal AIS icon

How it works

When the AIS Layer is enabled in the chart or radar application, AIS targets are shown on your display. You can add any AIS target to a "Buddy List", each entry consisting of an MMSI number, and an optional name. Subsequently, whenever Buddy Tracking is enabled on your multifunction display, and a "Buddy" vessel with an MMSI number sails into the range of your AIS receiver, an AIS Buddy icon is displayed. Up to 100 vessels may be added to the Buddy List.

Pre-requisites

The following items are required for the Buddy Tracking feature:

- For the purposes of using the Buddy Tracking feature, it is assumed that your display is already connected to a suitable AIS unit.
- Only transmitting AIS-equipped vessels will be detected.

Enabling and disabling buddy tracking in the chart application

From the chart application, with the AIS Targets layer enabled:

1. Select **Menu**.
2. Select **AIS Options**.
3. Select **MARPA & AIS Options**.
4. Select **Buddy Tracking**.

Selecting Buddy Tracking will switch between buddy tracking On and Off.

Enabling and disabling buddy tracking in the radar application

From the radar application, with the AIS Targets layer enabled:

1. Select **Menu**.
2. Select **Track Targets**.
3. Select **MARPA & AIS Options**.
4. Select **Buddy Tracking**.

Selecting Buddy Tracking will switch between buddy tracking On and Off.

Adding a vessel to your buddy list

In the chart or radar application:

1. Select the AIS target.
The AIS target context menu is displayed.
2. Select **Add Buddy**.
 - i. Select **Yes** to enter a name for the buddy vessel

- ii. Select **No** to save the vessel to your buddy list without entering a name for the buddy vessel.

The vessel will now be added to your buddy directory.

Adding a vessel to your buddy list from AIS target list

1. If you are in the chart application, goto **Menu > AIS Options**.
2. If you are in the radar application, goto **Menu > Track Targets > View MARPA & AIS Lists**.
3. Select **View AIS List**.
The AIS Target List is displayed.
4. Select an AIS target.
5. Select **Add Buddy**.
 - i. Select **Yes** to enter a name for the buddy vessel
 - ii. Select **No** to save the vessel to your buddy list without entering a name for the buddy vessel.

The vessel will now be added to your buddy directory.

Editing a buddy's details

From the chart or radar application:

1. Select the AIS buddy target.
The AIS buddy context menu is displayed.
2. Select **View Buddy List**.
3. Select the buddy you wish to edit.
The Buddy options dialog is displayed.
4. To change the MMSI number select **Edit Buddy MMSI** or.
The MMSI number must be 9 digits.
5. Select **Edit Buddy Name** to change the buddy name.
This could be the name of the vessel, or the name of the friend who owns the vessel, for example
6. Enter the new details and select **SAVE**.
You will be returned to the buddy list.

Deleting a buddy

From the chart or radar application:

1. Select the AIS buddy target.
The AIS buddy context menu is displayed.
2. Select **Remove Buddy**.
3. Select **Yes** to confirm.
The buddy has now been removed from the directory.

The buddy directory can also be accessed via the chart application (**Menu > AIS Options > View Buddy Directory**), or the radar application (**Menu > Track Targets > MARPA & AIS Lists > View Buddy Directory**).

Displaying additional buddy information

From the chart or radar application:

1. Select the AIS buddy target.
The AIS buddy context menu is displayed.
2. Select **Buddy Data** so that On is highlighted.
Selecting Buddy Data will switch data between On and Off.

The Buddy MMSI and Name will now be displayed next to the buddy icon.

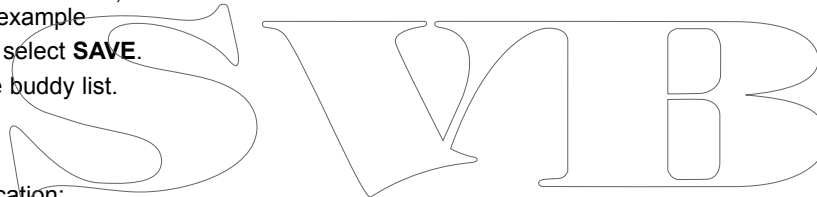

Chapter 15: Using the fishfinder

Chapter contents

- [15.1 How the fishfinder works on page 172](#)
- [15.2 Raymarine sonar modules on page 172](#)
- [15.3 Traditional sonar technology on page 173](#)
- [15.4 Broadband CHIRP sonar technology on page 173](#)
- [15.5 Fishfinder introduction on page 174](#)
- [15.6 Transducer bandwidth on page 175](#)
- [15.7 The sonar image on page 175](#)
- [15.8 Fishfinder presets on page 176](#)
- [15.9 Dual / Single frequency fishfinder on page 177](#)
- [15.10 Non-CHIRP \(traditional\) sonar module frequency controls on page 177](#)
- [15.11 CHIRP sonar module frequency controls on page 178](#)
- [15.12 Fishfinder display modes on page 180](#)
- [15.13 Fishfinder range on page 181](#)
- [15.14 Fishfinder sensitivity settings on page 182](#)
- [15.15 Fishfinder presentation options on page 185](#)
- [15.16 Depth and distance with the fishfinder on page 186](#)
- [15.17 Fishfinder scrolling on page 187](#)
- [15.18 Fishfinder waypoints on page 188](#)
- [15.19 Fishfinder alarms on page 188](#)
- [15.20 Sounder set-up menu options on page 189](#)
- [15.21 Transducer set-up menu options on page 190](#)
- [15.22 Resetting the sonar on page 191](#)

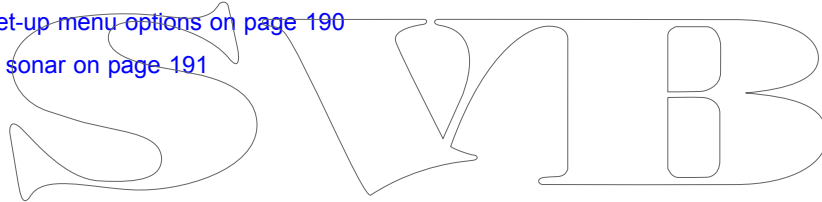

15.1 How the fishfinder works

The fishfinder application uses a sonar module and a suitable sonar transducer. The sonar module interprets signals from the transducer and builds up a detailed underwater view.

The transducer is located on the bottom of the boat, it sends pulses of sound waves into the water and measures the time it takes for the sound wave to travel to the bottom and back. The returning echoes are affected by bottom structure and by any other objects in their path, for example reefs, wrecks, shoals or fish.

Colors are used on the display to indicate the strength of the returns. You can use this information to determine the bottom structure, the size of fish and other objects in the water, such as debris or air bubbles

Note: Some transducers include additional sensors to measure water temperature and/or speed.

15.2 Raymarine sonar modules

The table below lists Raymarine's sonar modules and whether CHIRP technology is used.

DSM30	clear pulse – non-CHIRP
DSM300	clear pulse – non-CHIRP
CP450C	clear pulse – CHIRP
New a Series (internal sonar)	clear pulse – non-CHIRP
New c Series (internal sonar)	clear pulse – non-CHIRP
New e Series (internal sonar)	clear pulse – non-CHIRP

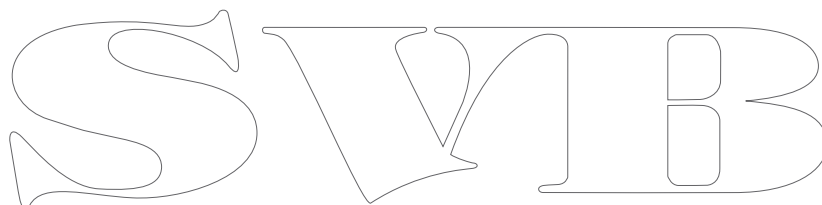
The logo consists of the letters 'S', 'W', 'I', and 'B' in a highly stylized, outlined font. The 'S' is a simple outline. The 'W' is formed by two 'V' shapes joined at the top. The 'I' is a simple vertical bar with a small horizontal bar at the top. The 'B' is a simple outline with a vertical stem and two rounded bowls.

15.3 Traditional sonar technology

Traditional sounders use a single carrier frequency or carrier wave for the sonar ping. These sounders work by measuring the time it takes the ping echo to return to the transducer to determine target depth. Using this method if 2 targets are close together they can be shown as a single large target, rather than multiple smaller targets

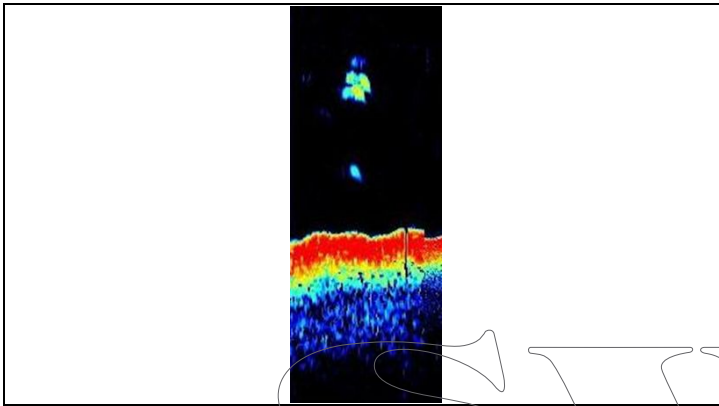
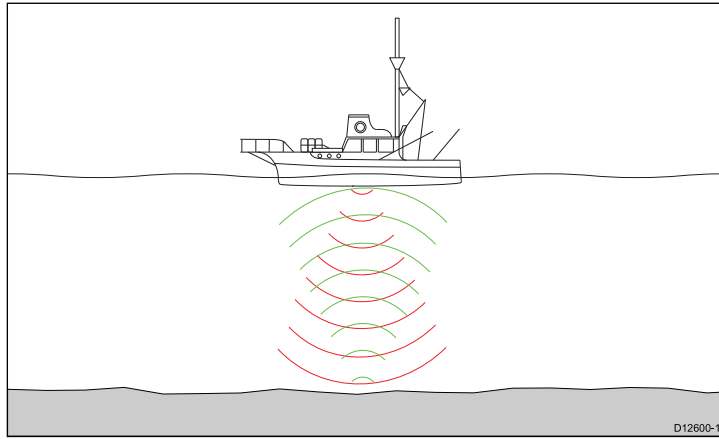

15.4 Broadband CHIRP sonar technology

Broadband sonars use a swept frequency 'CHIRP' signal which can distinguish between multiple close targets, this enables the sonar to display multiple targets instead of large combined targets.

Some of the benefits are improved:

- Target resolution.
- Bottom detection even through bait balls and thermoclines.
- Detection sensitivity.

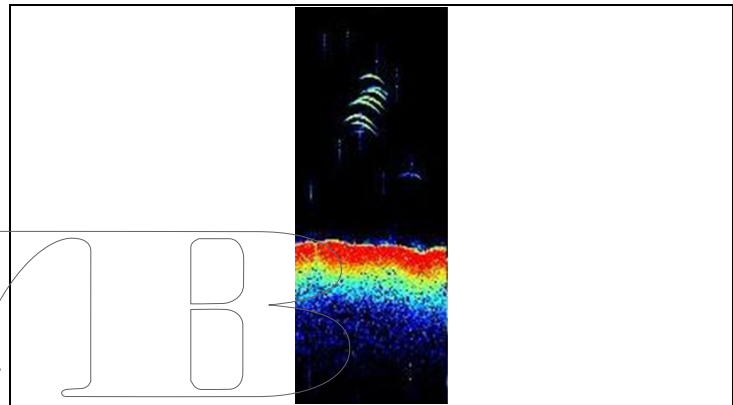
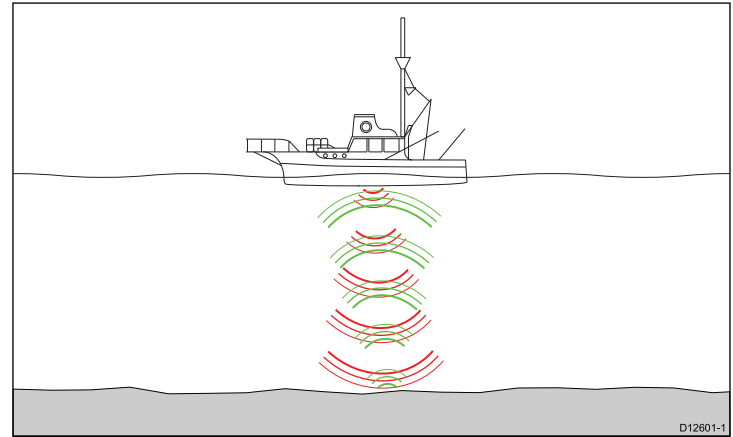

15.5 Fishfinder introduction



Warning: Sonar operation

- NEVER operate the sonar with the vessel out of the water.
- NEVER touch the transducer face when the sonar is powered on.
- SWITCH OFF the sonar if divers are likely to be within 7.6 m (25 ft) of the transducer.

Fishfinder overview

The fishfinder application provides a detailed view of the fish and seabed under your vessel, enabling you to accurately distinguish between different sizes of fish, bottom structure, and underwater obstacles. The standard fishfinder image is a historical, scrolling bottom graph with range and sonar frequency automatically selected by the system.

The various functions and features of the fishfinder application include:

- Preset modes for easy optimal operation.
- Display modes (Zoom, A-Scope or Bottom Lock).
- Adjustable range and zoom.
- Finding bottom feeding fish with the **bottom lock** display mode.
- Clutter and gain options to simplify the image.
- Pausing and adjusting the speed of the scrolling image.
- Using waypoints to mark a position.
- Determining depths and distances of targets.
- Fishfinder alarms (fish, depth or water temperature).

Fishfinder screen

The fishfinder displays a scrolling image of the seabed, updating from the right as your vessel makes progress.

Example fishfinder screen

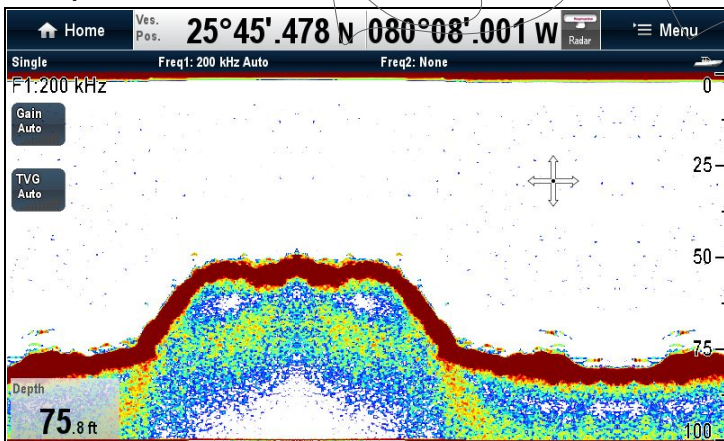

The fishfinder window includes the following aspects:

- The bottom together with any bottom structure such as reefs and shipwrecks etc.
- Target images indicating fish.
- A status bar noting the frequency and gain settings.
- The bottom depth.

Status icon

The fishfinder status icon is located on the Status icon bar:



- **Icon animated** - fishfinder is operating.
- **Icon static** - the fishfinder transducer is connected but not transmitting.
- **Icon greyed-out** - no fishfinder transducer is connected.

Fishfinder context menu

The fishfinder application includes a context menu which provides fishfinder information and shortcuts to menu items.

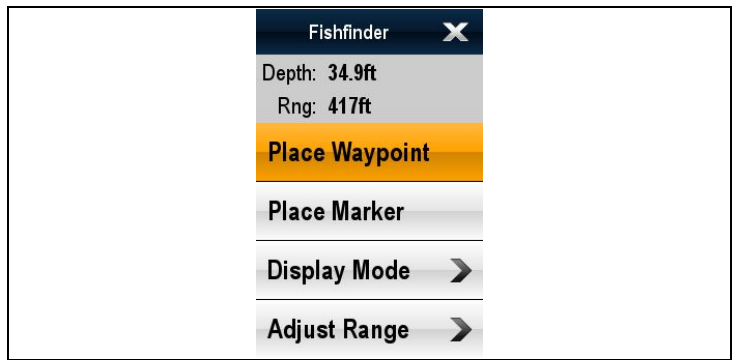

The context menu provides the data for the position of the cursor:

- Depth
- Range

The context menu also provide the following menu items:

- **Place Waypoint**
- **Place Marker**
- **Move Marker** — (only available if a marker has been placed.)
- **Erase Marker**— (only available if a marker has been placed.)
- **Display mode** — (opens the display mode menu.)
- **Adjust Range**— (opens the Range mode menu.)
- **Range shift**— (opens the Range shift menu.)

Accessing the context menu

You can access the context menu by following the steps below.

1. New e Series or New c Series:
 - i. Selecting a location, object or target on-screen and pressing the **Ok** button.
2. Touchscreen multifunction displays:
 - i. Selecting an object or target on-screen.
 - ii. Selecting and holding on a location on-screen.

15.6 Transducer bandwidth

The fishfinder application displays the fishfinder frequency, center frequency or CHIRP mode depending on the connected sonar module and transducer.

Example of CHIRP sonar module in CHIRP mode.

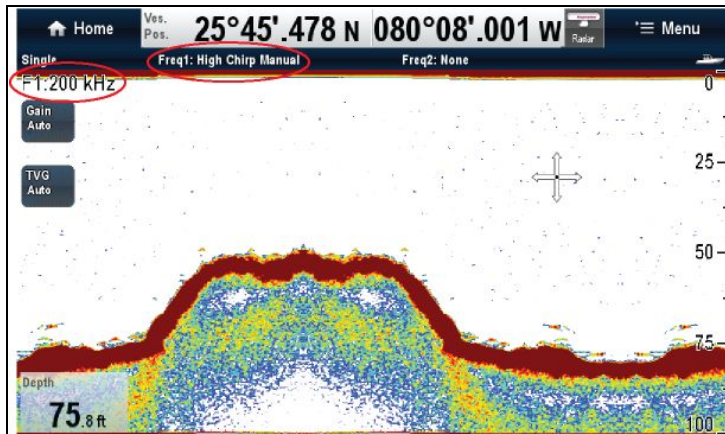

- When using a CHIRP sonar module set to CHIRP mode and a wide band transducer the CHIRP mode is shown in the fishfinder application title bar and the center frequency is displayed on-screen.
- When using a CHIRP sonar module set to a non-CHIRP mode and a wide band transducer the center frequency for the transducer is shown in the fishfinder application title bar and is displayed on-screen.
- When using a CHIRP sonar module connected to a non-CHIRP (traditional) transducer the CHIRP sonar module will behave the same as a non-CHIRP (traditional) sonar module.
- When using a non-Chirp sonar module the transducer's operating frequency is displayed in the fishfinder application title bar and is displayed on-screen.

Note: When using a CHIRP sonar module in non-CHIRP mode only the transducer's center frequency is displayed, this may be different to the actual frequency transmitted.

15.7 The sonar image

Interpreting the seabed using sonar

It is important to understand how to correctly interpret the seabed structure represented in the fishfinder display.

The seabed usually produces a strong echo.

The following images show how different seabed conditions are represented in the sonar display:

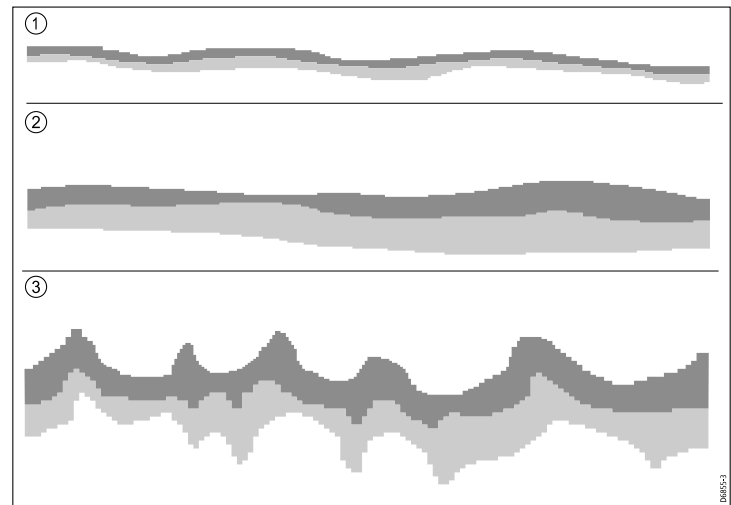

Item	Description
1	A hard bottom (sand) produces a thin line.
2	A soft bottom (mud or seaweed cover) produces a wide line.
3	A rocky or uneven bottom or a wreck produces an irregular image with peaks and troughs.

The dark layers indicate a good echo; the lighter areas indicate weaker echoes. This could mean that the upper layer is soft and therefore allowing sound waves to pass to the more solid layer below.

It is also possible that the sound waves are making two complete trips – hitting the seabed, bouncing off the vessel, then reflecting off the seabed again. This can happen if the water is shallow, the seabed is hard, or the gain is set to high.

Factors influencing the sonar display

The quality and accuracy of the display can be influenced by a number of factors including vessel speed, depth, object size, background noise and transducer frequency.

Vessel speed

The shape of the target changes along with your speed. Slower speeds return flatter, more horizontal marks. Higher speeds cause the target to thicken and arch slightly, until at fast speeds the mark resembles a double vertical line.

Target depth

The closer the target to the surface, the larger the mark on screen.

The depth of individual targets can be displayed by switching on the **Target Depth ID** in the fishfinder menu **Menu > Presentation**. The number of target depths displayed is influenced by the fish alarm sensitivity level.

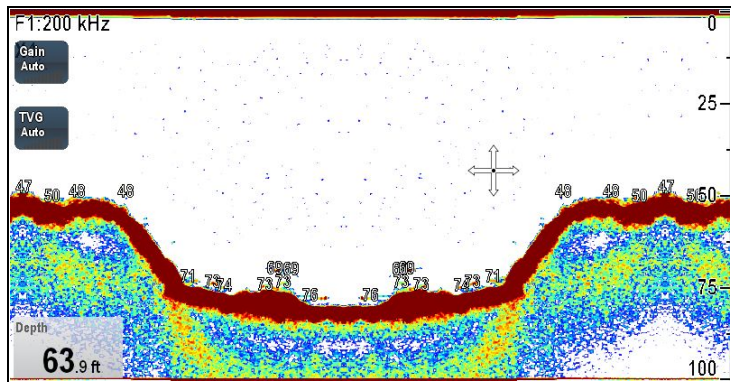

Water depth

As sea depth increases signal strength decreases, resulting in a lighter on-screen image of the bottom.

Size of the target

The larger the target, the larger the return on the fishfinder display. The size of a fish target is also dependent upon the size of the fish's swim bladder rather than its overall size. The swim bladder varies in size between different breeds of fish.

Transducer frequency

The same target will appear differently when the transducer frequency is changed. The lower the frequency the broader the mark.

Clutter / Background noise

The fishfinder picture may be impaired by echoes received from floating or submerged debris, air bubbles or even the vessel's movement. This is known as 'background noise' or 'clutter' and is controlled by the gain modes. The system will automatically control the gain settings according to the depth and water conditions. You can however adjust the gain settings manually if you prefer.

Recovering lost bottom

If the seabed floor (bottom) is lost then follow the steps below to recover the bottom depth.

From the fishfinder application:

1. Ensure your vessel is in clear undisturbed water.
2. If sonar range is set to Manual, adjust the sonar range to the known, charted depth of your location. or
3. If sonar range is set to Auto then switch range to manual **Menu > Range > Adjust Range > Man** and adjust the sonar range to the known, charted depth of your location.
4. Once the sonar module has regained the bottom you can switch range mode back to Auto.

15.8 Fishfinder presets

The fishfinder provides you with four preset configurations available from the fishfinder menu. These enable you to quickly select appropriate settings tailored for various situations.

Each preset has been configured to provide the best operating parameters for the fishfinder. However, it is possible to manually adjust the presets if necessary. The four default presets are:

- **Single** — this preset provides quick access to a single-frequency configuration, suitable for general fishing conditions.
- **Dual** — this preset provides a dual frequency configuration. You can either display two different frequencies at the same time in one window, or display one frequency at full-screen on your master display and the other frequency at full-screen on an additional networked display.
- **Shallow** — this preset optimizes the fishfinder display for shallow waters.
- **Deep** — this preset optimizes the fishfinder display for deep waters.

Display modes

When using presets, you can either select the relevant preset and start using the default configuration immediately, or you can adjust and configure each preset's display mode:

- Zoom
- Bottom Lock
- A-Scope

Any changes you make to a preset are retained when you switch off the power to your multifunction display.

Selecting a fishfinder preset

From the fishfinder application:

1. Select **Menu**.
2. Select **Presets**.
3. Select the required preset.

The fishfinder display will change to the new mode. This is indicated in the top left-hand corner of the status bar.

Changing fishfinder preset names

From the fishfinder application:

1. Select **Menu**.
2. Select **Set-up**.
3. Select **Rename Preset**.
4. Select the required characters.
5. Select **Save** to save the new preset name.

Resetting presets to defaults

To reset the preset settings to factory default values follow the steps below:

From the fishfinder application:

1. Select **Menu**.
2. Select **Set-up**.
3. Select **Reset Presets to Default**.
A confirmation pop-up is displayed.
4. Select **Yes** to confirm reset, or **No** to cancel.

15.9 Dual / Single frequency fishfinder

Dual frequency operation allows the sonar to operate and display 2 frequencies simultaneously. If the preset mode that you are using has two frequencies configured, you can view either one or both of those frequencies in separate windows.

Selecting dual frequency view

From the fishfinder application:

1. Select **Menu**.
2. Select **Presets**.
3. Select **Dual**.

The main fishfinder menu is displayed.

4. Select **View Freq**.
5. Select the required setting:
 - Frequency 1
 - Frequency 2
 - Both

15.10 Non-CHIRP (traditional) sonar module frequency controls

The frequency of the sonar determines the width of the sonar beam, the depth to which the signals will penetrate and the resolution of the image.

The frequencies supported depend upon the sonar module and transducer in use on your system.

- **Auto**. When operating in automatic the system will set and the frequency automatically to suit your transducer operating conditions.
- **Lower frequencies** (e.g. 50 kHz) produce a wide sonar beam and penetrate the water well. Lower frequencies provide a lower resolution image that may not be as good at detecting small fish. Use lower frequencies if you require a large coverage beneath your vessel or if you are in deep water.
- **Higher frequencies** (e.g. 200 kHz) produce narrow beam and produce a high resolution image. They are most useful in shallower water (up to 1000 ft) and at higher speeds.

The non-CHIRP sonar module will only operate at specific frequencies defined by the connected transducer (e.g. 50 kHz or 200 kHz).

Setting the fishfinder frequency (non-CHIRP sonar module)

With the **Frequency settings** menu options you can configure **frequency 1** or **frequency 2**.

1. From the fishfinder application select **Menu**.
2. Select **Frequency settings**.
3. Select **Freq 1** or **Freq 2** as required.
4. Select the required frequency:

Example of Frequency setting menu when connected to a non-CHIRP sonar module.

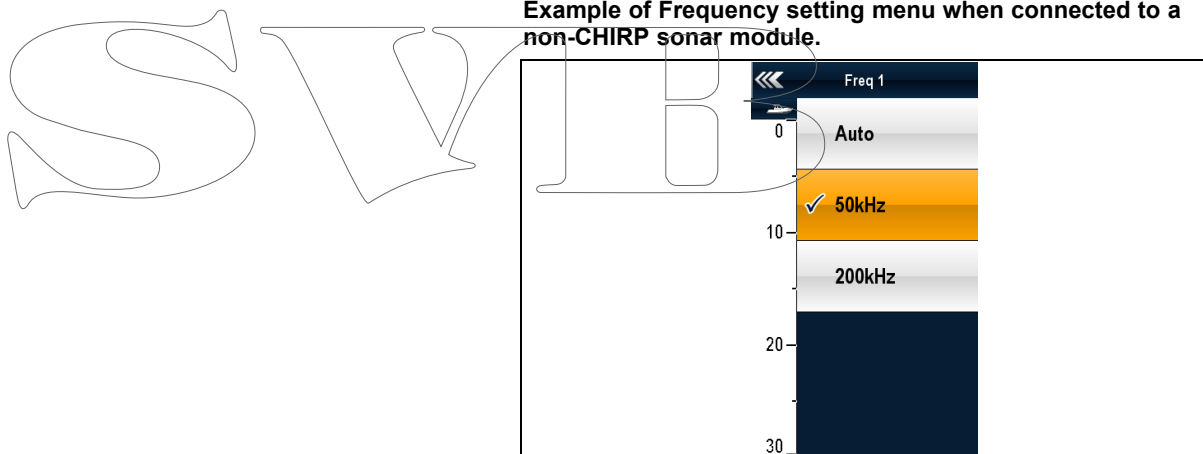

Frequency tuning (non-CHIRP sonar module)

When connected to a non-CHIRP transducer there will be an **optimum** frequency for the maximum sensitivity of the transducer. The sonar module can be fine tuned to this frequency.

Non-CHIRP sonar module frequency

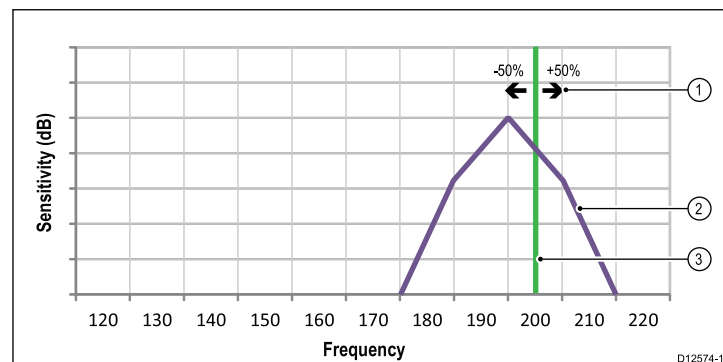

1. Tuning range.
2. Transducer characteristics.
3. Operating frequency.

The graph above depicts an example of the fine tuning (from —50% to +50%) available when the frequency is set to 200 kHz.

Tuning the fishfinder frequency (non-CHIRP sonar module)

When connected to a non-CHIRP sonar module you can manually tune the fishfinder frequency.

From the fishfinder application:

1. select **Menu**.
2. Select **Frequency settings**.
3. Select either **Tune Freq 1** or **Tune Freq 2** as required.

The Tune Frequency slider bar is displayed:

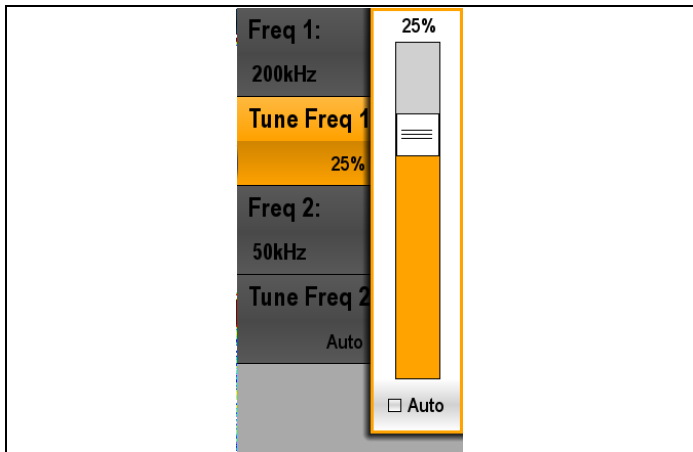

4. Adjust the slider to the required value.
the optimum frequency will be when the echo returns are the strongest on the screen.
5. Select **Back** to close the tune frequency slider bar, or
6. Select **Ok** to set the tune frequency to automatic.

15.11 CHIRP sonar module frequency controls

The frequency of the sonar determines the width of the sonar beam, the depth to which the signals will penetrate and the resolution of the image

The frequencies supported depend upon the sonar module and transducer in use on your system:

- Lower frequencies produce a wider sonar beam and penetrate the water well. A lower frequency provides a lower resolution image that may not be as good at detecting small fish. Use lower frequencies if you require a large coverage beneath your vessel or if you are in deep water.
- Higher frequencies produce narrower beam and produce a high resolution image. They are most useful in shallower water (up to 1000 ft) and at higher speeds.

The options available (dependant upon connected sonar module and transducer) are :

- **Auto**. When operating in automatic the system will select the frequency automatically to suit your transducer and operating conditions.
- **Low frequency** (e.g. 50 kHz) (non-CHIRP mode).
- **Medium frequency** (e.g. 90 kHz) (non-CHIRP mode).
- **High frequency** (e.g. 160 kHz) (non-CHIRP mode).
- **Low Chirp** (e.g. 42 to 65 kHz) (CHIRP mode).
- **Med Chirp** (e.g. 85 to 135 kHz) (CHIRP mode).
- **High Chirp** (e.g.) 130 to 210 kHz) (CHIRP mode).

Note: If a CHIRP sonar module is connected to a (traditional) non-CHIRP transducer the CHIRP sonar module operates as a non-CHIRP sonar module.

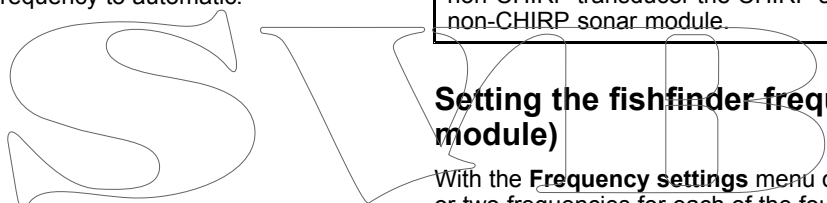

Setting the fishfinder frequency (CHIRP sonar module)

With the **Frequency settings** menu options you can configure one or two frequencies for each of the four presets.

1. From the fishfinder application select **Menu**.
2. Select **Frequency settings**.
3. Select **Freq 1** or **Freq 2** as required.
4. Select the required frequency:

Example of Frequency setting menu when connected to a CHIRP sonar module.

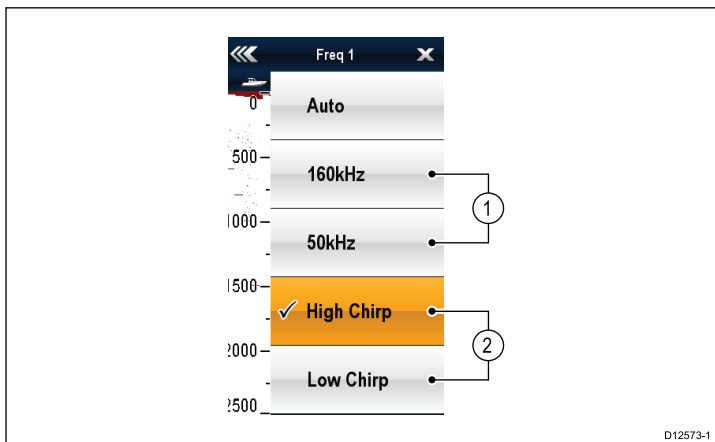

1. Non-CHIRP modes
2. CHIRP modes.

Frequency adjustment (CHIRP sonar module in non-CHIRP mode)

When using a CHIRP sonar module in CHIRP mode (Low Chirp, Med Chirp or High Chirp) the frequency cannot be adjusted. When using a CHIRP sonar module in a non-Chirp mode (e.g. 50 kHz or 160 kHz) the frequency at which the transducer is transmitting can be adjusted.

With the CHIRP sonar module set to a CHIRP mode (e.g. Low Chirp or High Chirp) the CHIRP sonar module will sweep the transducer's available frequency range in each ping.

With the CHIRP sonar module set to a non-CHIRP mode (e.g. 50 kHz or 160 kHz) the CHIRP sonar module can adjust the frequency at which the transducer is transmitting. The advantages of being able to adjust the transmit frequency include:

- Optimization for particular species of fish and water conditions.
- Avoiding interference from other sonar operating nearby (at the same frequency).
- Use of wide or narrow beam on a particular transducer.

The graph below depicts the adjustment (selection of a specific) frequency when using a CHIRP sonar set to 160 kHz.

CHIRP sonar module frequency

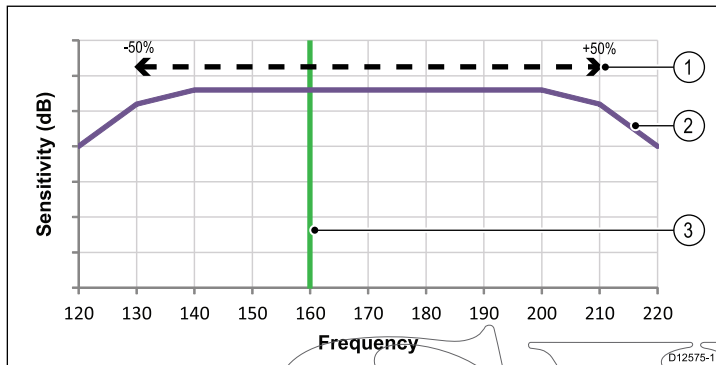

1. Frequency adjustment range.
2. Transducer characteristics.
3. Operating (center) frequency.

Adjusting the fishfinder frequency (CHIRP sonar module in non-CHIRP mode)

When connected to a CHIRP sonar module set to a non-CHIRP mode you can manually adjust the transmit frequency.

From the fishfinder application:

1. select **Menu**.
2. Select **Frequency settings**.
3. Select either **Tune Freq 1** or **Tune Freq 2** as required.

The Frequency adjust slider bar is displayed:

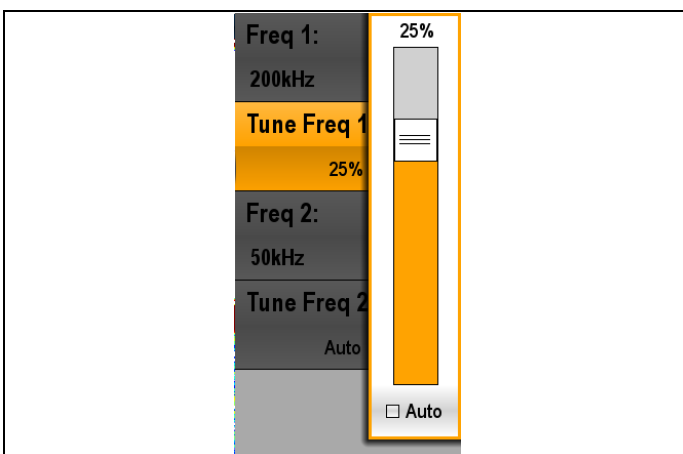

4. Adjust the slider to the required value.
5. Select **Back** to close the adjust frequency slider bar, or
6. Select **Ok** to set the adjust frequency to automatic.

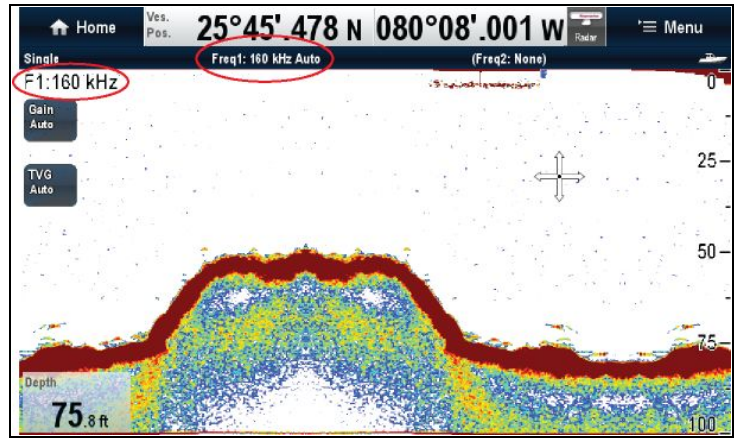

Note: When manually adjusting the frequency the actual frequency of operation is not displayed, the fishfinder application title bar displays the transducers center frequency.

15.12 Fishfinder display modes

Selecting a fishfinder display mode

From the fishfinder application:

1. Select **Menu**.
2. Select **Display Mode**.
3. With dual frequency preset set, select **Adjust** to select which frequency display you wish to change.
Selecting Adjust in Dual frequency preset will switch between Frequency 1 and Frequency 2.
4. Select the **Select Mode** menu item.
5. Select the required display mode:
 - None
 - Zoom
 - Bottom Lock
 - A-Scope

Fishfinder zoom mode

The zoom display mode magnifies a region of the fishfinder screen to display more detail.

This zoom option enables you to:

- Replace the standard fishfinder image with the zoomed image, or display the zoomed image alongside the standard fishfinder image.
- Set the zoom factor to a predefined level, or adjust it manually.
- Reposition the zoomed portion of the image to a different point in the display.

When the range increases, the area shown in the zoom window also increases.

Zoom split

With the zoom display mode you can split the screen and display the zoomed image alongside the standard fishfinder image (ZOOM SPLIT). The zoomed section is indicated on the standard fishfinder screen by a zoom box.

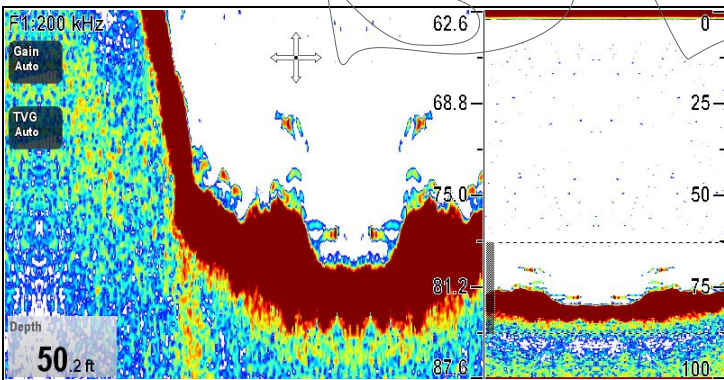

Selecting split screen in zoom mode

From the fishfinder application, with the zoom display mode selected:

1. Select **Menu**.
2. Select **Display Mode**.
3. Select **Zoom** so that Split is highlighted.
Selecting Zoom will switch between Split and Full.

Adjusting the fishfinder zoom factor

When the zoom function is active (Zoom Full or Zoom Split), you can either select a predefined zoom factor or adjust it manually.

From the fishfinder application, with Zoom preset selected:

1. Select **Menu**.
2. Select **Display Mode**.
3. Select **Zoom Factor**.
4. Select a preset Zoom Factor (**x2**, **x3**, **x4**) or select **Manual**
Once selection is made you will be returned to the Display Mode menu.
5. If Manual is chosen select **Manual Zoom**
The manual zoom factor dialog is displayed.

6. Adjust the setting to the required value.
7. Select **Back** or use the **Ok** button to confirm the setting.

Adjusting the position of the fishfinder zoomed area

When the zoom function is selected, the system automatically selects the zoom position so that the bottom details are always in the lower half of the display. If required you can reposition the portion of the image to be zoomed so that an alternative area is displayed.

From the fishfinder application, with Zoom preset selected:

1. Select **Menu**.
2. Select **Display Mode**.
3. Select **Zoom Position**.
The zoom position menu is displayed.
4. Select **Zoom Position**.
Selecting the zoom position displays the zoom position slider bar control.
5. Adjust the setting to the required value, or select Auto to switch to automatic.

Fishfinder A-Scope mode

The A-Scope mode enables you to view a live (rather than historical) image of the seabed and fish directly below your vessel.

The standard fishfinder display shows a historical record of fishfinder echoes. If required, you can display a live image of the bottom structure and the fish directly below the transducer by using the A-Scope feature. The width of the bottom covered by the A-Scope is indicated at the bottom of the window. A-Scope provides a more precise and easier to interpret indication of the target strength.

There are three A-Scope modes:

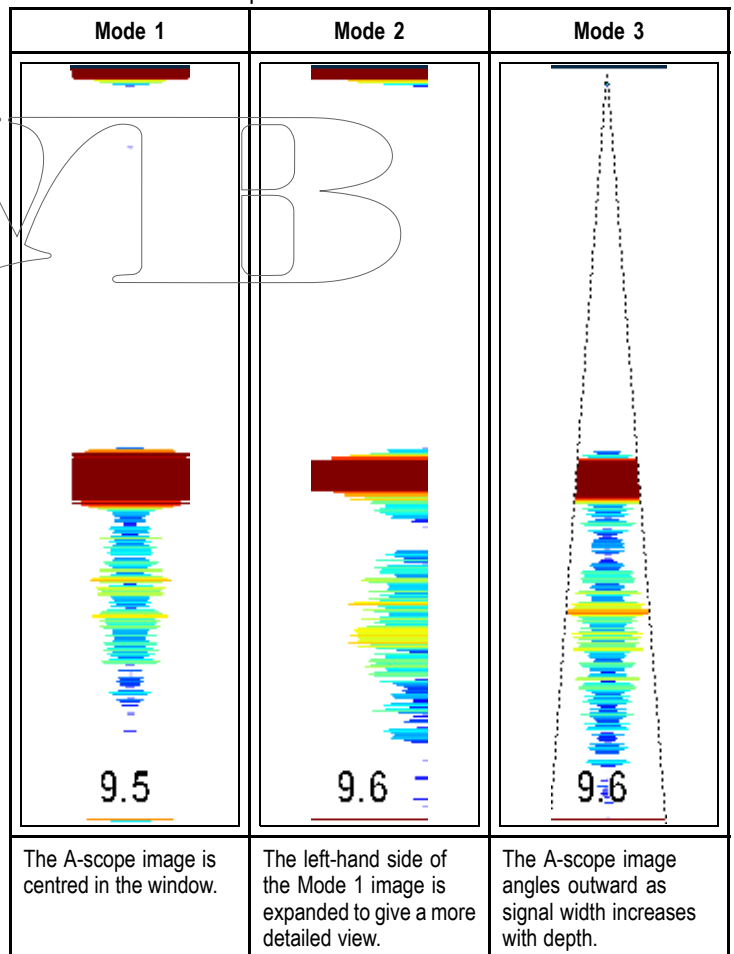

Selecting A-Scope mode

From the fishfinder application, with the A-Scope display mode selected:

1. Select **Menu**.
2. Select **Display Mode**.
3. Select **A-Scope Mode**.
4. Select **A-Scope** to display a list of A-Scope modes.
5. Select the required A-Scope mode.

Bottom Lock

The Bottom Lock function applies a filter to flatten the image of the seabed and make any objects on or just above it easier to discern. This feature is particularly useful for finding fish that feed close to the bottom.

Bottom Lock is selected for individual fishfinder windows and can replace or appear alongside the standard fishfinder image. Adjusting the range of the bottom lock image allows you to view more bottom details. You can also reposition the image on screen to anywhere between the bottom of the window (0%) and the middle of the window (50%) by using the Bottom Shift control.

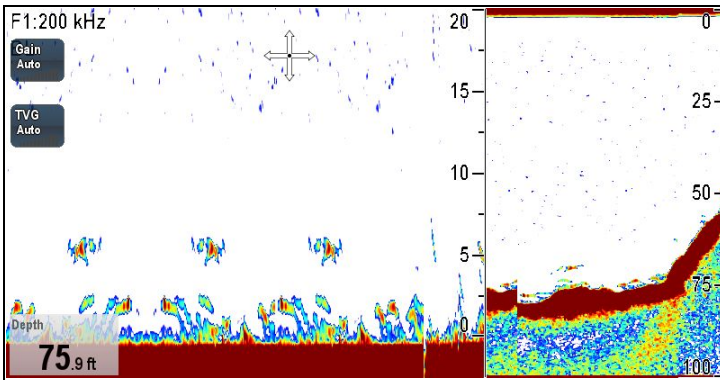

Bottom Lock is selected for individual fishfinder windows and can either replace (ON) or appear alongside (SPLIT) the standard fishfinder image.

Adjusting the bottom lock range/position

From the fishfinder application, with bottom lock display mode selected:

1. Select **Menu**.
2. Select **Display Mode**.
3. Select **Bottom Lock** to switch between Full screen and Split screen
4. Select **B-Lock Range**.
Selecting Bottom Lock Range will display the B-Lock Range dialog.
5. Adjust the B-Lock setting to the required value.
6. Select **Back** or use the **Ok** button to confirm the setting.

15.13 Fishfinder range

The Range and Range Shift functions enable you to change the range of depth displayed by the fishfinder.

Range

The Range function enables you to define the range of depth that you see in the fishfinder display.

By default, the fishfinder display shows the shallowest required range, enabling you to clearly see what is near the surface of the water under your vessel. This is useful for finding smaller fish that feed nearer the surface. An example of this kind of depth range is 0 to 200 feet. In this case, the range is 200 feet, so 200 feet of water will be displayed on-screen at any one time.

There may be circumstances in which you want to see a less detailed image showing a greater amount of depth beneath your vessel. This is useful for locating bigger fish and other objects located closer to the seabed such as wrecks. An example of this kind of depth range is 0 to 1000 feet or greater. In this case, the range is 1000 feet, and you will be able to see 1000 feet of water beneath your vessel, without needing to scroll the display up or down.

Range Shift

The Range Shift function enables you to define which area of the overall depth you want to be able to see on-screen. For example, if your range is 5000 feet and the display is showing the surface (0 feet) at the very top of the display, and 5000 feet at the bottom of the display, you can use the Range Shift function to focus on a different 5000 foot range. For example, 2000 feet at the very top of the screen, and 7000 feet at the very bottom of the screen.

Example screen with range and range shift used to view the seabed at a depth range of 20–100 ft

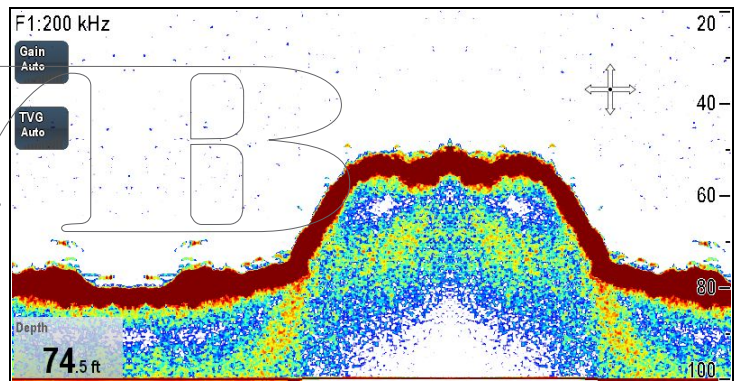

Changing the fishfinder depth range

From the fishfinder application

You can choose from either:

- **automatic** adjustment whereby the display automatically shows the shallowest required range.
- **manual** adjustment of the depth range, up to the maximum depth displayed on the scrolling bottom and A-Scope images.

Changes to the range affect all fishfinder windows.



1. Select **Menu**.
2. Select **Range**.
3. Select **Range** to switch between Auto and Man.
4. With manual mode selected you can now use the **Range Controls** to adjust the depth range shown in the fishfinder application.

Note: With the **Range** menu displayed you cannot use the **Rotary Control** to range in and out. To use the **Rotary control** to range in and out, first close the **Range** menu.

Range in and out

The method of ranging in and out of the fishfinder application is dependant upon your multifunction display variant.

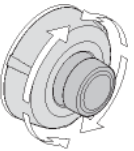
The table below shows the Range controls available for each display variant.

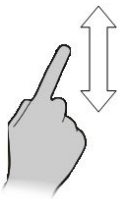
	Rotary Control	<ul style="list-style-type: none"> • New c Series • New e Series
	Range in and Range out buttons	<ul style="list-style-type: none"> • New c Series • New e Series (excluding e7 and e7D)
	Slide the screen Up or Down	<ul style="list-style-type: none"> • New e Series

15.14 Fishfinder sensitivity settings

The **Sensitivity settings** menu provides access to features and functions which enhance what is displayed on screen.

Sensitivity options include:

- **Gain**
- **Gain Mode** — Only available when connected to a non-CHIRP sonar module including the internal sonar module.
- **Color Gain**
- **TVG**
- **Color Threshold**
- **Power Mode**

Sonar gain

The gain settings alter the way the sonar module processes background noise (also called clutter). Adjusting the gain settings can improve the sonar image, however for optimum performance in most conditions, we recommend that you use the auto settings.

The gain adjusts the return threshold (echo strength) above which the fishfinder will show an object on the screen.

There are two gain modes:

- Auto
- Manual

Auto

In Auto mode, the sonar module automatically adjusts the gain setting to suit current conditions. Any adjustments made apply to all fishfinder windows using that particular frequency.

For Raymarine sonar modules which do not have CHIRP capabilities there are three Auto modes, each suited to different scenarios:

- **Cruising (Low)** is ideal for viewing fishfinder images with a minimum of background noise as you are cruising to your fishing spot. Only the strongest echoes are displayed.
- **Trolling (Medium)** is a slightly higher gain setting that displays more detail. This is the default mode.
- **Fishing (High)** provides the most detail, but also displays the most background noise and surface clutter.

Manual

If necessary you can set the gain controls manually, between a value of 0% to 100%. This value should be set high enough to see fish and bottom detail but without too much background noise. Generally a high gain is used in deep and/or clear water; a low gain in shallow and/or murky water.

The new values remain set even when you switch off the display, they are applied to both the active window and any other fishfinder windows with the same frequency.

Selecting the frequency for gain adjustments

When connected to a Raymarine CHIRP sonar module, the gain for frequency 1 and frequency 2 can be changed independently or both at the same time. If connected to a non-CHIRP sonar module adjustments will be made to both frequencies simultaneously.

From the fishfinder application:

1. Select **Menu**.
2. Select **Sensitivity Settings**.
3. Select **Gain**.
4. Select **Adjust**.
5. Select **Frequency 1, Frequency 2 or Both**.

Adjusting fishfinder gain using the menu

The fishfinder gain setting can be accessed from the fishfinder menu.

From the fishfinder application:

1. Select **Menu**.
2. Select **Sensitivity Settings**.
3. Select **Gain**.
The Gain adjust dialog is displayed
4. Adjust the gain control to the required setting, or

Using fishfinder range shift

The default setting adjusts the display to keep the seabed in the lower half of the display window. Alternatively you can shift the image within the current range. Changes to the range shift are reflected in all fishfinder windows.

From the fishfinder application, with the **Range Mode** set to Manual:

1. Select **Menu**.
2. Select **Range**.
3. Select **Range Shift**.
The range shift dialog is displayed.
4. Adjust the setting to the required value.
5. Select the **Range Shift** menu.
6. Use the **Rotary Control** to adjust the Range Shift to the required setting.
7. Select **Back** or press the **Ok** button to confirm the setting and close the range shift dialog.

Fishfinder (dual frequency) independent range

When connected to a Raymarine CHIRP sonar module, the range for frequency 1 and frequency 2 can be changed independently or both at the same time.

Adjusting range on each frequency independently

1. Select **Menu**.
2. Select **Range**.
3. Select **Adjust**.
4. Select **Frequency 1, Frequency 2 or Both**.
5. Exit the menu.
6. Use the **Range control** to change the range for the selected frequency.



Adjusting range using the touchscreen

You can adjust the range using the touchscreen.

From the fishfinder application, with the range set to manual:

1. Select an area on-screen for the frequency you want to adjust.
2. Slide your finger **Up** or **Down** to adjust the range for that frequency.

Note: Frequencies can only be adjusted independently when connected to a Raymarine CHIRP sonar module.

5. Select **Auto**.

A tick is displayed in the **Auto** box to signify automatic gain is enabled.

Setting the auto gain mode for non-CHIRP sonar modules

When using a non-CHIRP sonar module, from the fishfinder application:

1. Select **Menu**.
2. Select **Sensitivity Settings**.
3. Select **Gain Mode**.

A list of available auto gain modes is displayed:

- Cruising (Low)
- Trolling (Med)
- Fishing (High)

4. Select the required auto gain mode.



Fishfinder gain on-screen controls

Touchscreen multifunction displays provide on-screen access to the gain controls.

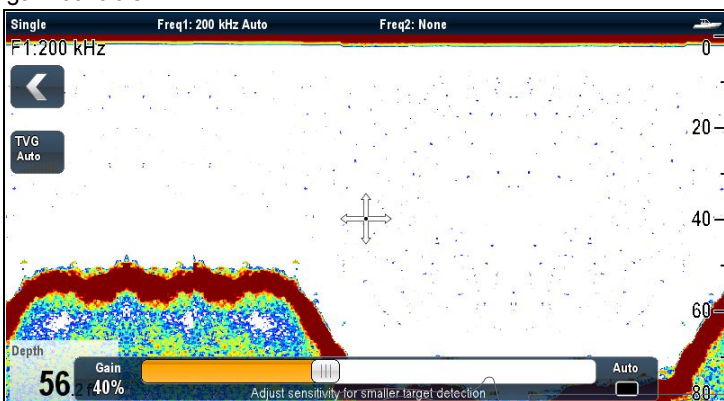

Selecting the on-screen gain control will display the gain settings:

When connected to a non-CHIRP sonar module the automatic gain has 3 modes:



When connected to a CHIRP sonar module no automatic gain modes are required:

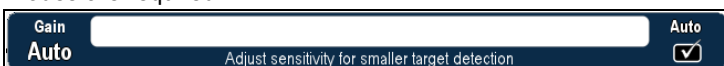

When in manual mode the slider bar control is shown:



Note: New c Series gain controls are accessed by the menu options: **Menu > Sensitivity Settings > Gain**.



Enabling and disabling on-screen gain controls

You can enable and disable the on-screen gain controls by following the steps below.

On a touchscreen multifunction display, with the relevant application displayed.

1. Select **Menu**.
2. Select **Presentation**.
3. Select **Gain Controls**.

Select Gain Controls will switch between showing and hiding the on-screen controls.



Adjusting fishfinder gain manually using on-screen controls

Touchscreen multifunction displays provide on-screen access to the gain controls.

1. Select the on-screen **Gain** control located on the left hand side of the fishfinder application.
2. Select the **Auto** box to switch between Auto and Manual gain.
3. With **Auto** deselected, select and hold the **Slider** and move **Left** to decrease value or **Right** to increase value.



Setting auto gain using the on-screen controls

Touchscreen multifunction displays provide on-screen access to the gain controls.

1. Select the on-screen **Gain** control located on the left hand side of the fishfinder application.
2. Select the **Auto** box to select Auto gain mode.
3. When connected to a non-CHIRP sonar module you can select the Auto gain mode:
 - Cruising
 - Trolling
 - Fishing

Fishfinder color gain

You can adjust the color gain to change the signal strength threshold for the strongest color in your fishfinder display.

Color gain sets the lower limit for the strongest echo color. All echoes with a signal strength above this value are displayed in the strongest color. Those with a weaker value are divided equally between the remaining colors.

- Setting a low value produces wide band for the weakest color, but a small signal band for the other colors.
- Setting a high value gives a wide band for the strongest color, but a small signal band for the other colors.

There are two color gain modes:

- **Auto** — In Auto mode the color gain setting is automatically adjusted to suit current conditions. Any adjustments made apply to all fishfinder windows.
- **Manual** — You can set the color gain manually, between a value of 0% to 100%.

Adjusting the fishfinder color gain

From the fishfinder application:

1. Select **Menu**.
2. Select **Sensitivity settings**.
3. Select **Color Gain**.

The color gain slider bar control is displayed.

4. Adjust the control to the required value.
5. Select **Back** to confirm setting and close slider bar, or
6. Select **Auto** to enable automatic color gain.

The new values remain set even when you switch off the display and are applied to all fishfinder windows.

Fishfinder TVG (Time Varied Gain)

The Time Varied Gain (TVG) function reduces the amount of clutter in the fishfinder display by varying the gain throughout the column of water. This function is useful for reducing the appearance of 'noise'.

The operation of the TVG settings is dependant upon the connected sonar module.

Non-CHIRP sonar modules

- Increasing the TVG value increases the maximum depth to which TVG is applied. A high value decreases the gain in shallow water so that only the strongest echoes are displayed.
- Decreasing the TVG value reduces the maximum depth. A low TVG value has little effect on gain in shallow water.

TVG adjustment can be made automatically or manually.

CHIRP sonar modules

- A high value increases the gain in shallow water so that more targets are displayed.
- A low value reduces the gain in shallow water so that less clutter is displayed

TVG adjustment can be made automatically or manually.

TVG Presets and auto settings

When connected to a Raymarine CHIRP sonar module 3 preset TVG options are available:

- Low

- Medium
- High

When connected to a Raymarine sonar module without CHIRP capabilities an automatic setting is available:

- Auto

Selecting the frequency for TVG adjustments

When connected to a Raymarine CHIRP sonar module, the TVG for frequency 1 and frequency 2 can be changed independently or both at the same time. If connected to a non-CHIRP sonar module adjustments will be made to both frequencies simultaneously.

From the fishfinder application:

1. Select **Menu**.
2. Select **Sensitivity Settings**.
3. Select **TVG**.
4. Select **Adjust**.
5. Select **Frequency 1, Frequency 2** or **Both**.

Selecting a preset TVG setting

TVG preset options are only available when connected to a Raymarine CHIRP sonar module.

With TVG set to Auto, from the fishfinder application:

1. Select **Menu**.
2. Select **Sensitivity Settings**.
3. Select **TVG**.
4. Select **TVG Mode**.
5. Select the required setting: Low, Medium or High.

Selecting the TVG Auto setting

The Auto setting for TVG is only available on Raymarine non-CHIRP sonar modules.

From the fishfinder application:

1. Select **Menu**.
2. Select **Sensitivity Settings**.
3. Select **TVG**.
The TVG slider bar control is displayed.
4. Select **Auto** so that a tick is placed in the auto box.

Manually adjusting the fishfinder TVG

From the fishfinder application:

1. Select **Menu**.
2. Select **Sensitivity Settings**.
3. Select **TVG**.
The TVG slider bar control is displayed.
4. Select **Auto** so that the tick is removed from the Auto box.
5. Adjust the slider bar control to the required setting.
6. Select Back to confirm setting and close slider bar control.

Note: TVG has no effect in fishfinder simulator mode.

TVG on-screen controls

Touchscreen multifunction displays provide on-screen access to the TVG controls.

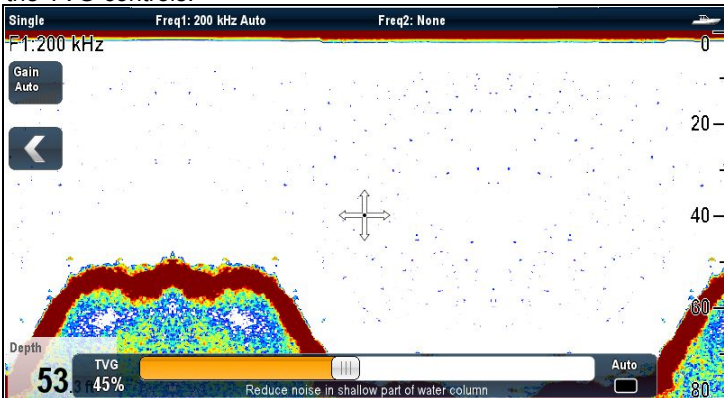

Selecting the on-screen TVG control will display the TVG settings:

CHIRP controls

When connected to a CHIRP sonar module the automatic TVG has 3 modes:



When in manual mode the slider bar control is shown:



Non-CHIRP controls

TVG auto modes are not available when connected to a non-CHIRP sonar module:



When in manual mode the slider bar control is shown:

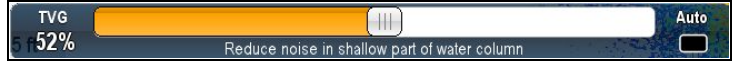

Note: New c Series TVG controls are accessed by the menu options: **Menu > Sensitivity Settings > TVG**.



Enabling and disabling on-screen gain controls

You can enable and disable the on-screen gain controls by following the steps below.

On a touchscreen multifunction display, with the relevant application displayed.

1. Select **Menu**.
2. Select **Presentation**.
3. Select **Gain Controls**.
Select Gain Controls will switch between showing and hiding the on-screen controls.



Setting the frequency for TVG using the on-screen controls

When connected to a Raymarine CHIRP sonar module, the TVG for frequency 1 and frequency 2 can be changed independently or both at the same time.

1. Select the on-screen **TVG** control located on the left hand side of the fishfinder application.
2. Select the **Freq** box so that a tick is placed in the box to adjust both frequencies at the same time, or
3. Select a frequency on-screen so that the window is highlighted, adjustments will then only be made to the selected frequency.



Adjusting fishfinder TVG manually using on-screen controls

Touchscreen multifunction displays provide on-screen access to the TVG controls.

1. Select the on-screen **TVG** control located on the left hand side of the fishfinder application.
2. Select the **Auto** box to switch between Auto and Manual TVG.
3. With **Auto** deselected, select and hold the **Slider** and move **Left** to decrease value or **Right** to increase value.



Setting auto TVG using the on-screen controls

Touchscreen multifunction displays provide on-screen access to the TVG controls.

1. Select the on-screen **TVG** control located on the left hand side of the fishfinder application.
2. Select the **Auto** box to select Auto TVG mode.
3. When connected to a CHIRP sonar module you can select the Auto TVG mode:
 - Low
 - Medium
 - High

Fishfinder color threshold

The color threshold setting determines the range of colors used on screen. The effect of this is to set a color threshold below which targets are not shown. For example a low setting would result in only the strongest (orange and red) targets being displayed.

Adjusting the fishfinder color threshold

From the fishfinder application:

1. Select **Menu**.

2. Select **Sensitivity Settings**.
3. Select **Color Threshold**.
Selecting color threshold displays the numeric adjust control.
4. Adjust the color threshold to the required setting.
5. Select **Ok** to confirm setting and close the numeric adjust control.

Fishfinder power

The power setting controls the power level of the transducer.

Power options:

- **Auto**. This is the default setting. When it is selected the sonar module automatically determines the required power setting based on the current depth, speed, and (bottom) signal strength.
- **Manual**. If you wish to manually adjust the power to suit current conditions, you can adjust the power level between 0% and 100%, in 10% increments. Lower power levels are normally used in depth ranges less than 8 ft. (2.4 m) and higher power levels are typically selected for depths greater than 12 ft. (3.7 m).

Setting the frequency for power mode

When connected to a Raymarine CHIRP sonar module, the power mode for frequency 1 and frequency 2 can be changed independently or both at the same time. If connected to a non-CHIRP sonar module adjustments will be made to both frequencies simultaneously.

1. Select **Menu**.
2. Select **Sensitivity Settings**.
3. Select **Power Mode**.
4. Select **Adjust**.
5. Select **Frequency 1, Frequency 2 or Both**.

Adjusting the fishfinder power

From the fishfinder application:

1. Select **Menu**.
2. Select **Sensitivity settings**.
3. Select **Power Mode**.
The power mode slider bar control is displayed.
4. Adjust the slider bar to the required setting, or
5. Select **Auto** to place power mode into automatic.

The new values remain set even when you switch off the display and are applied to all fishfinder windows.

15.15 Fishfinder presentation options

The **Presentation** menu gives you access to features and functions which provide additional on-screen functionality.

Presentation options include:

Menu Item	Description	Options
Target Depth ID	Controls whether the depth of identified targets are displayed. The level of targets displayed is directly linked to the level of Fish Alarm sensitivity.	<ul style="list-style-type: none"> • On • Off
Depth Lines	Controls whether horizontal lines indicating depth are displayed.	<ul style="list-style-type: none"> • On • Off
White Lines	When set to On, this option displays a white line along the contour of the seabed. This helps to distinguish objects close to the bottom.	<ul style="list-style-type: none"> • On • Off
Bottom Fill	When set to On, this option displays a solid color fill for the seabed.	<ul style="list-style-type: none"> • On • Off
Color Palette	Various color palettes are available to suit different conditions and your personal preference.	<ul style="list-style-type: none"> • Classic Blue • Classic Black • Classic White • Sunburst • Greyscale • Inverse Greyscale • Copper • Night Vision
Ping Rate	Hyper Ping is a fishfinder setting for use when travelling at high speed in shallow waters. When set to Hyper the display will provide an accurate, undistorted image of the bottom at speeds of up to 40 kt. Note: The ping rate option is not available when connected to a Raymarine CHIRP sonar module.	<ul style="list-style-type: none"> • Normal • Hyper
Scroll Speed	Specify the fishfinder scroll speed.	<ul style="list-style-type: none"> • 10% — 100%
Gain controls	Controls whether or not the on-screen Gain and TVG controls are shown or not Note: Gain controls setting is only available on touchscreen multifunction displays.	<ul style="list-style-type: none"> • Show (default) • Hide
Data Overlay Set-up	Allows you to set up and display/hide up to 2 data cells in the bottom left corner of the screen: • Data Cell 1	Data Cell 1 <ul style="list-style-type: none"> • On • Off Select Data Category

Menu Item	Description	Options
	<ul style="list-style-type: none"> Select Data Category Data Cell 2 Select Data Category 	Allows selection of a data type by category. Data Cell 2 <ul style="list-style-type: none"> On Off Select Data Category Allows selection of a data type by category.

15.16 Depth and distance with the fishfinder

The fishfinder display provides a number of features to help you determine depths and distances. These features are illustrated and described in more detail below:

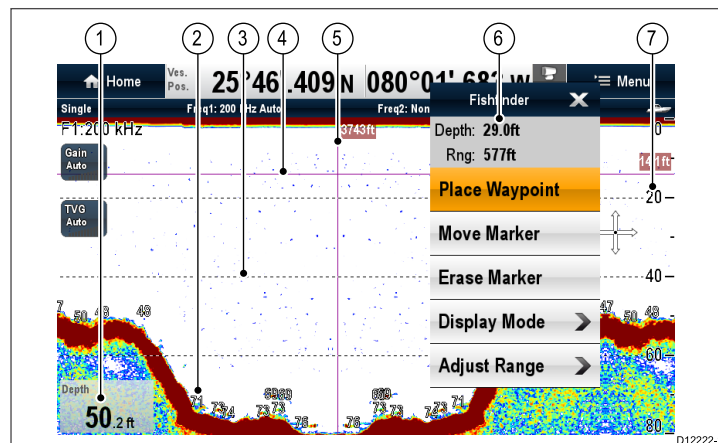

Item	Description
1	Depth reading — current depth of seabed.
2	Depth Target ID — depths are displayed against recognized targets. The sensitivity of these IDs is directly linked to the Fish Alarm sensitivity; the greater the fish alarm sensitivity, the greater the number of labelled returns.
3	Depth lines — horizontal dashed lines drawn at regular intervals to indicate the depth from the surface.
4	Horizontal VRM marker — indicates the depth of the target.
5	Vertical VRM marker — indicates the distance behind your vessel.
6	Cursor Depth — this is the depth of the cursor position.
7	Depth markers — these numbers indicate depth.

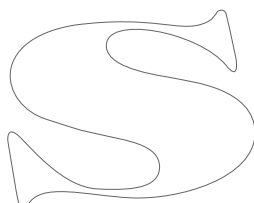

Measuring depth and distance with VRM

You can use a Variable Range Marker (VRM) to determine an object's depth and distance behind your vessel. These markers consist of a horizontal (depth) line and a vertical (distance) line, each of which are labelled with the appropriate measurement.

From the fishfinder application:

1. Select **Menu**
2. Select **Scroll** so that Pause is highlighted (This may make it easier to position the marker).
Selecting Scroll will switch the scroll between Pause and Resume.
3. Open the **fishfinder context menu**.
4. Select **Place Marker**.
5. Select the location you want to place the marker.

Note: Once placed you can move the marker by selecting **Move Marker** from the fishfinder context menu.

Fishfinder marker context menu

The fishfinder marker includes a context menu which provides marker information and menu items.

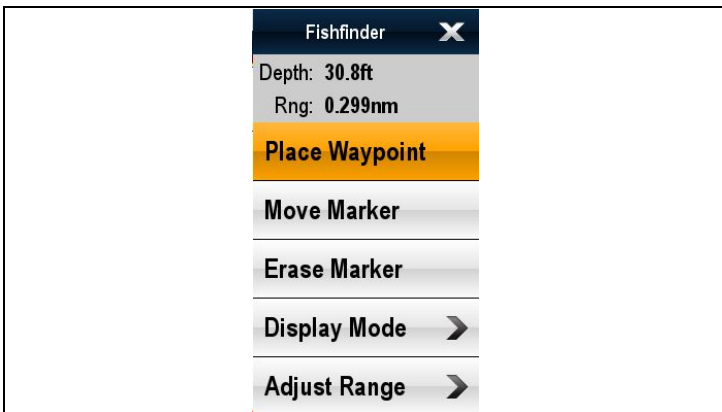

15.17 Fishfinder scrolling

The fishfinder image scrolls from right to left. You can pause the scrolling or adjust the scroll speed, to ease placing of waypoints or VRMs on-screen.

Scroll speed

You can adjust the speed at which the fishfinder image scrolls. A faster speed provides more detail which may be useful when you are looking for fish. If you select a slower speed the information remains on the display for longer.

Scroll pause

You can pause the display to see a 'snapshot' of the fishfinder image. When the image is paused scrolling stops but the depth indication continues to be updated. Scroll pause/resume affects the currently selected fishfinder frequency.

If you are in dual frequency mode, you can pause one frequency while the other continues to scroll. This allows you to inspect a paused image while the other frequency continues to scroll and detect fish.

Note: Scrolling will resume if the frequency changes. For example an automatic change of frequency resulting from a change in depth.

Adjusting the fishfinder scrolling speed

From the fishfinder application:

1. Select **Menu**.
2. Select **Presentation**.
3. Select **Scroll Speed**.
The Scroll speed numeric adjust control is displayed.
4. Adjust the value to the required setting.
5. Select **Ok** to confirm and close the numeric adjust control.

Pausing the fishfinder scrolling image

From the fishfinder application:

1. Select **Menu**.
2. Select **Scroll** so that Pause is highlighted.
Selecting Scroll will switch between Scroll Pause/Resume.

The context menu provides data for the position of the marker:

- Depth
- Range

The context menu also provides the following menu items:

- **Place Waypoint**
- **Move Marker**
- **Erase Marker**
- **Display Mode**
- **Adjust Range**

Accessing the context menu

You can access the context menu by following the steps below.

1. New e Series or New c Series:
 - i. Selecting a location, object or target on-screen and pressing the **Ok** button.
2. Touchscreen multifunction displays:
 - i. Selecting an object or target on-screen.
 - ii. Selecting and holding on a location on-screen.

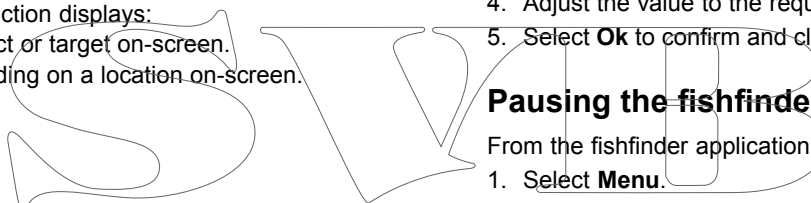

15.18 Fishfinder waypoints

Placing a waypoint on the fishfinder display enables you to mark a position so that you can return to it later.

When a waypoint is placed, its details are added to the waypoint list and a vertical line labelled WPT is displayed on-screen. The waypoints can then be navigated to using the chart application.

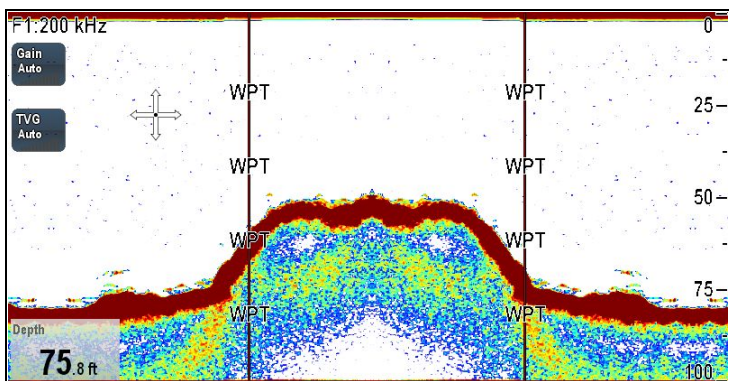

Placing a Waypoint in the fishfinder application

From the fishfinder application:

1. Select and hold the required location.
The fishfinder context menu is displayed.
2. Select **Place Waypoint**.

Placing a waypoint using the WPT button or icon

From the fishfinder application:

1. Select **WPT**.
The waypoint menu is displayed.
2. Whilst the waypoint menu is open:
 - Select **WPT** again to place a waypoint at your vessels position, or
 - Select the appropriate option: Place Waypoint At Vessel, Place Waypoint At Cursor or Place Waypoint At Lat/Ion.

Placing a Waypoint using the context menu

You can place a waypoint in the fishfinder application using the context menu.

1. Open the **fishfinder context menu**.
2. Select **Place Waypoint**.
The Waypoint is placed at the cursors location and a confirmation pop-up is displayed.
3. Select **Ok** to confirm waypoint placement, or
4. Select **Edit** to edit the new waypoints details.

15.19 Fishfinder alarms

The display can be configured to provide a number of fishfinder alarms.

The following fishfinder alarms can be set when a sonar module is detected, or when the simulator is on:

- **Fish** — alarm sounds when a target meets the specified sensitivity level and, is within the depth limits (if enabled). The greater the fish alarm sensitivity, the greater the number of target image depths displayed.
- **Fishfinder Deep** — alarm sounds when the sonar module detects that the depth is greater than the deep limit.
- **Fishfinder Shallow** — alarm sounds when the sonar module detects that the depth is less than the shallow limit.

Setting up fish alarms

From the Alarms menu **homescreen > Set-up > Alarms**:

1. Select **Fish**.
The Fish alarms menu is displayed.
2. Select **Fish** so that On is highlighted.
3. Select **Fish Sensitivity**.
The fish sensitivity numeric adjust control is displayed.
4. Adjust the fish sensitivity to the require value.
The greater the fish alarm sensitivity, the greater the number of target image depths displayed.
5. Select **Fish Depth Limits** so that **On** is highlighted.
The shallow and deep fish limit settings will be activated in the menu.
6. Select **Shallow Fish Limit**.
The shallow fish limit numeric adjust control is displayed.
7. Adjust the value to the require setting.
8. Select **Ok** to confirm the new value and close the numeric adjust control.
9. Select **Deep Fish Limit**.
The deep fish limit numeric adjust control is displayed.
10. Adjust the value to the require setting.
11. Select **Ok** to confirm the new value and close the numeric adjust control.

Setting up fishfinder deep alarm

From the Alarms menu **homescreen > Set-up > Alarms**:

1. Select **Fishfinder Deep**.
2. Select Deep so that On is highlighted.
Selecting Deep will switch between On and Off.
3. Select **Deep Limit**.
The deep limit numeric adjust control is displayed.
4. Adjust the setting to the required value.
5. Select **Ok** to confirm the new value and close the numeric adjust control.

Note: The Deep Limit cannot be set to less than the Shallow Limit.

Setting up fishfinder shallow alarm

From the Alarms menu **homescreen > Set-up > Alarms**:

1. Select **Fishfinder Shallow**.
2. Select Shallow so that On is highlighted.
Selecting Shallow will switch between On and Off.
3. Select **Shallow Limit**.
The shallow limit numeric adjust control is displayed.
4. Adjust the setting to the required value.
5. Select **Ok** to confirm the new value and close the numeric adjust control.

Note: The Shallow Limit cannot be set to greater than the Deep Limit.

15.20 Sounder set-up menu options

This section describes the settings you can change using the sounder set up menu: (**Menu > Set-up > Sounder Set-up**). The set up menu contains settings that are likely to be changed infrequently.

Menu Item	Description	Options
Internal Sounder	<p>Switch the built in sonar on and off, for use when you have more than one multifunction display with internal sonar.</p> <p>Note: Disabled on non-sonar variants.</p> <p>Note: Must be set to Off if an external sonar is connected.</p>	<ul style="list-style-type: none"> • On • Off
Ping Rate Limit	<p>Provides a speed limiter; it is useful to adjust the ping rate to suit local conditions. For example, the ping rate may be too fast when there is a hard bottom in shallow water. The internal sonar reverts to 26 pings per second when the sonar module is powered off.</p> <p>Note: Ping rate limit is disabled if Ping rate is set to hyper in the presentation menu.</p>	<ul style="list-style-type: none"> • Internal sonar: 5 — 50 pings per second • CHIRP sonar: 5 — 80 pings per second
Ping Enable	<p>The sonar ping is normally enabled. It can be disabled. This is useful when other equipment is being tested, or if someone is diving beneath the boat. This setting reverts to Enabled when the sonar module is powered off.</p>	<ul style="list-style-type: none"> • On • Off
Interference rejection	<p>Removes spikes caused by other fishfinder-equipped vessels.</p> <p>Note: Interference rejection will be disabled in Hyper Ping mode</p>	<ul style="list-style-type: none"> • Auto • Low • Medium • High
2nd Echo IR	<p>Adjusts the ping rate in small increments, according to the 2nd echo level. This results in better sensitivity of the image.</p> <p>Note: 2nd Echo IR will be disabled in Hyper Ping mode</p>	<ul style="list-style-type: none"> • Off • Low • High
Sonar reset	<p>Restore all settings on the sonar module to factory default. When performing a sonar Reset, it is normal to briefly loose connection with the sonar module.</p>	<ul style="list-style-type: none"> • Yes • No
Trip Counter Reset	<p>Resets the Trip Counter of the sonar module</p>	<ul style="list-style-type: none"> • Yes • No

15.21 Transducer set-up menu options

The **Transducer Set-up** menu should be used when setting up your multifunction display for the first time or when installing a depth transducer.

Menu Item	Description	Options
Transducer	Select the appropriate transducer type from those displayed. Some transducer may be detected by the system automatically.	Options available are dependant on the sonar module connected.
Speed Transducer	Select the appropriate speed transducer from those available. This option is only available if you are not using a combined Depth/Speed or Depth/Speed/Temperature transducer.	Options available are dependant on the sonar module connected.
Depth Offset (waterline)	Offset represents the depth of the transducer (relative to the waterline).	• -9.9 to +9.9 feet — or equivalent units
Speed Offset	Offset applied to the speed log.	• 0 to 100%
Temperature Offset	Offset applied to the temperature transducer value.	• -9.9 to +9.9 °F — or equivalent units

Fishfinder Transducer Calibration

Your fishfinder transducer must be calibrated correctly to achieve accurate depth readings.

The multifunction display receives the image from a sonar module which processes sonar signals from a transducer mounted in the water. If the transducer is equipped with a speed paddle wheel and temperature-sensing thermistor, the sonar module calculates speed and temperature. To ensure accurate readings, it may be necessary to calibrate the transducer(s) by applying offsets to depth, speed and temperature. As these settings are held in the sonar module and relate to the transducer, they are applied system-wide.

Depth Offset

Depths are measured from the transducer to the sea bed, but you can apply an offset value to the depth data, so that the displayed depth reading represents the depth to the sea bed from either the keel or the water-line.

Before attempting to set a waterline or keel offset, find out the vertical separation between the transducer and either the waterline or the bottom of the keel on your vessel, as appropriate. Then set the appropriate depth offset value.

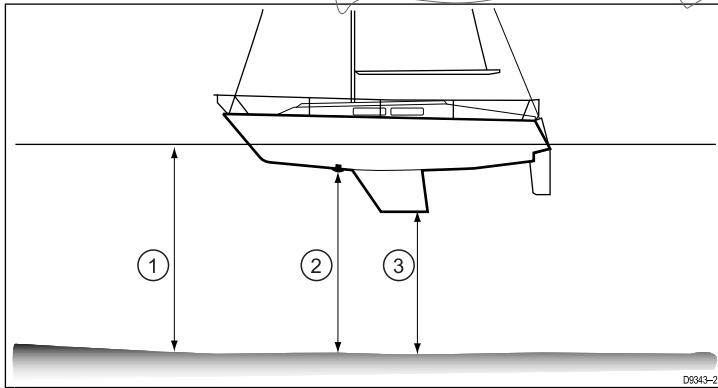

1	Waterline offset
2	Transducer / Zero offset
3	Keel offset

If an offset is not applied, displayed depth readings represent the distance from the transducer to the sea bed.

Setting the depth offset

From the fishfinder application:

1. Select **Menu**.
2. Select **Set-up**.
3. Select **Transducer Set-up**.
4. Select **Depth Offset**.
The depth offset numeric adjust control is displayed.
5. Adjust the offset to the required value.
6. Select **Ok** to confirm setting and close the numeric adjust control.

Setting the speed offset

From the fishfinder application:

1. Select **Menu**.
2. Select **Set-up**.
3. Select **Transducer Set-up**.
4. Select **Speed Offset**.
The speed offset numeric adjust control is displayed.
5. Adjust the offset to the required value.
6. Select **Ok** to confirm setting and close the numeric adjust control.

Setting the Temperature offset

1. Select **Menu**.
2. Select **Set-up**.
3. Select **Transducer Set-up**.
4. Select **Temperature Offset**.
The temperature offset numeric adjust control is displayed.
5. Adjust the offset to the required value.
6. Select **Ok** to confirm setting and close the numeric adjust control.

15.22 Resetting the sonar

The reset function restores the unit to its factory default values.

Note: Performing a factory reset will clear speed and temperature calibration settings and the depth offset.

1. Using a compatible Raymarine multifunction display go to the Fishfinder application page.
2. Select **Menu** from the side menu.
3. Select **Set-up**.
4. Select **Sounder Set-up**.
5. Select **Sonar reset**.
6. Select **Yes** to confirm.

The unit will now be reset to factory default settings.

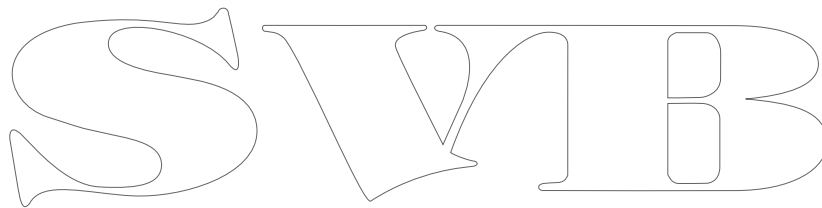
The image shows a large, stylized outline logo for the brand 'SWIB'. The letters are interconnected and have a decorative, calligraphic feel. The 'S' is on the left, followed by 'W', 'I', and 'B' on the right.

SWIB

Chapter 16: Using the data application

Chapter contents

- [16.1 Data application overview on page 194](#)
- [16.2 Pre-configured datapages on page 194](#)
- [16.3 Customizing the data application on page 196](#)

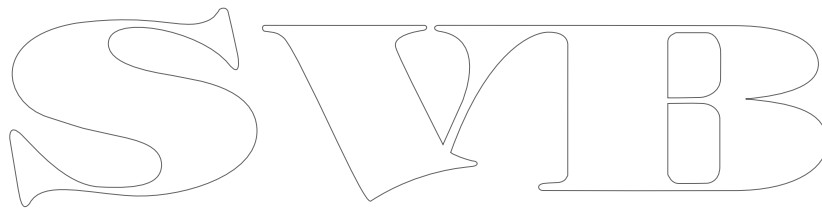

16.1 Data application overview

The data application displays system and instrument data on your multifunction display.

The data application enables you to view numeric data generated by the system. It also shows data from instruments connected to your multifunction display using the NMEA or SeaTalk^{ng} protocols.

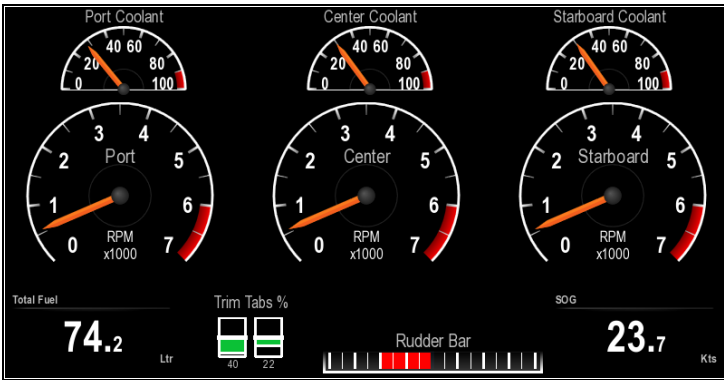

Selecting datapages

You can scroll through pre-configured and custom datapages using the touchscreen.

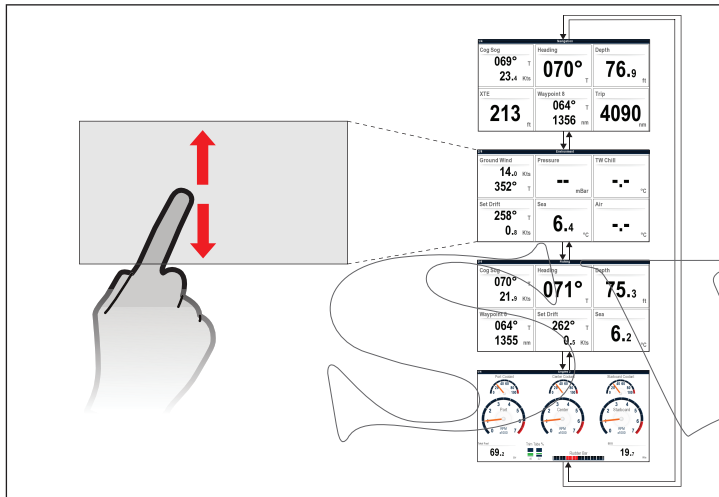

From the data application:

1. Touch the screen.
2. Slide your finger up and let go of the screen to go to the next datapage.
3. Slide your finger down and let go of the screen to go to the previous datapage.



Selecting datapages

To select datapages using a non-touch multifunction display follow the steps below.

From the data application:

1. Move the **Joystick Down** to goto the next page, or
2. Move the **Joystick Up** to goto the previous page.

16.2 Pre-configured datapages

By default, a pre-configured range of data is displayed in a number of datapages. Each datapage consists of a number of 'cells', each containing a different item of data.

Note: The datapages available, by default are dependant upon the type of vessel selected during the initial set up wizard and the number of engines selected in the data application menu.

Default page data items

Datapage	a65 / a67 / e7 / e7D	e95 / e97 / c95 / c97 / e125 / e127 / c125 / c127 / e165
Navigation panel	<ul style="list-style-type: none"> • COG & SOG • Heading • Depth • Cross Track error (XTE) • Waypoint . Goto Info • Trip 	<ul style="list-style-type: none"> • Rolling road • COG & SOG • Heading • Depth • Waypoint Info
Environmental panel	<ul style="list-style-type: none"> • GWS & GWD • Pressure • True Wind Chill • Set & Drift • Sea Temperature • Air Temperature 	<ul style="list-style-type: none"> • GWS & GWD • Pressure • True Wind Chill • AWA & AWS • Set & Drift • Sea Temperature • Air Temperature • Humidity
Sailing panel	<ul style="list-style-type: none"> • COG & SOG • Heading • Depth • AWS & AWA • VMG Wind • VMG wpt 	<ul style="list-style-type: none"> • COG & SOG • Compass • Depth • Speed through water • AWS & AWA • VMG Wind • VMG wpt • TWS & TWA
Fishing panel	<ul style="list-style-type: none"> • COG & SOG • Heading • Depth • Waypoint / Goto Info • Set & Drift • Sea Temperature 	<ul style="list-style-type: none"> • COG & SOG • Heading • Depth • Live well • Waypoint / Goto Info • Set & Drift • Sea Temperature • Local time
Engine (Number of engines = 1)	<ul style="list-style-type: none"> • Oil Pressure • Engine RPM • Coolant Temperature • Total Fuel • Rudder • SOG 	

Datapage	a65 / a67 / e7 / e7D	e95 / e97 / c95 / c97 / e125 / e127 / c125 / c127 / e165
Engine (Number of engines = 2)	<ul style="list-style-type: none"> • Port Oil Pressure • Port Coolant temperature • Port RPM • Trim tabs • Starboard Oil Pressure • Starboard Coolant temperature • Starboard RPM • Total Fuel • Rudder • SOG 	
Engine (Number of engines = 3)	<ul style="list-style-type: none"> • Port Coolant temperature • Port RPM • Center Coolant temperature • Center RPM • Starboard Coolant temperature • Starboard RPM • Total Fuel • Trim tabs • Rudder • SOG 	
Engine (Number of engines = 4)	<ul style="list-style-type: none"> • Port RPM • Center Port RPM • Center Starboard RPM • Starboard RPM • Engine economy total • Total fuel • Port Coolant temperature • Center Port Coolant temperature • Center Starboard Coolant temperature • Starboard Coolant temperature 	
Engine (Number of engines = 5)	<ul style="list-style-type: none"> • Port RPM • Center RPM • Starboard RPM • Center Port RPM • Center Starboard RPM • Rudder 	

Datapage	a65 / a67 / e7 / e7D	e95 / e97 / c95 / c97 / e125 / e127 / c125 / c127 / e165
Fuel	<ul style="list-style-type: none"> • Port Coolant temperature • Port Oil Pressure • Port Fuel remaining • Starboard Coolant temperature • Starboard Oil Pressure • Starboard Fuel remaining • Port RPM • Port alternator • Starboard RPM • Starboard alternator 	<p>Note: The data shown on the fuel page may vary depending on how many engines your system has configured.</p>

Rolling road	Rolling road
--------------	--------------

Note: Datapage selection is a local setting, and therefore only affects the individual display that you are currently using. It does not affect any networked displays.

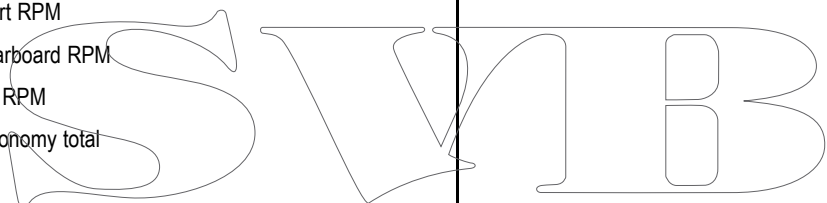

16.3 Customizing the data application

You can customize the data application to show the system and instrument data that you require.

In addition to displaying the default, pre-configured datapages in the data application, you can also:

- Change the order datapages appear.
- Customize datapages content to your specific requirements.
- Rename the datapages.
- Add new custom datapages.
- Delete existing datapages.
- Set the number of engines your vessel has (1 to 5).
- Set the maximum engine RPM range.
- Change page color theme and dial color.
- Reset all pages to default.

Changing datapage order

You can change the order that datapages appear.

From the data application:

1. Scroll to the datapage you want to move.
2. Select **Menu**.
3. Select **Edit Page**.

The edit page menu is displayed.

4. Select **Move Page Up** or **Move Page Down**.

Each time move page up or move page down is selected the datapage will be moved 1 space up or down in the data application.

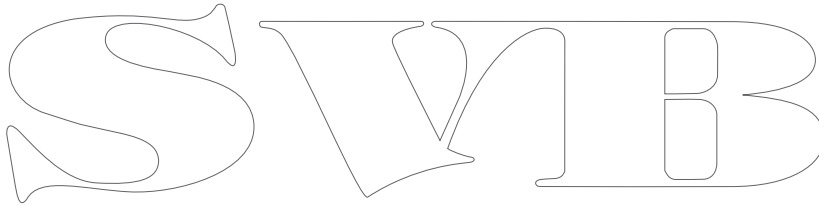

Customizing datapage content

From the data application:

1. Select **Menu**.
2. Select **Edit Page**.
3. Select the cell you want to change.
4. Select **Select Data Category**.
5. Select a data category.
Selecting a data category will display a list of data items for that category.

6. Select the data item you want to display.
Once selected a tick will be placed next to the data item in the menu and the cell on screen will display the new data item
7. Repeat steps 3 to 6 for all the data items you want to change.

List of data items

Depending on connected devices the categories of data available to display in the data application, data overlay, databar, and expanded databar are shown below.

The following table shows the data items available by category.

Data Category	Description	Data Item	Digital	Dial	Graphical
Boat	Types of data generated by your vessel. For example, tank levels.	Fresh Water	✓	✓	✗
		Grey Water	✓	✓	✗
		Black Water	✓	✓	✗
		Live Well	✓	✓	✗
		Trim Tabs (Only available in the Data application.)	✗	✗	✓
Depth	Depth data.	Depth	✓	✗	✗
Distance	Types of data related to distance travelled by your vessel. For example, trip distance.	Log & Trip	✓	✗	✗
		Log	✓	✗	✗
		Trip	✓	✗	✗
		Ground Log, Trip	✓	✗	✗
		Ground Log	✓	✗	✗
		Ground Trip 1	✓	✗	✗
		Ground Trip 2	✓	✗	✗
		Ground Trip 3	✓	✗	✗
		Ground Trip 4	✓	✗	✗
Engine	Types of data generated by engines. For example, oil pressure.	RPM	✓	✓	✗
		Coolant Temperature	✓	✓	✗
		Coolant Pressure	✓	✓	✗
		Oil Pressure	✓	✓	✗
		Boost Pressure	✓	✓	✗
		Alternator	✓	✓	✗
		Engine Load	✓	✓	✗
		Engine Hours	✓	✗	✗
		Engine Tilt	✓	✗	✗

Data Category	Description	Data Item	Digital	Dial	Graphical
Fuel	Types of data related to the fuel system. For example, fuel levels. Note: The options displayed are dependant on the number of engines set in the data application.	Fuel Level 1 (vol)	✓	✗	✗
		Fuel Level 2 (vol)	✓	✗	✗
		Fuel Level 3 (vol)	✓	✗	✗
		Fuel Level 1 (%)	✓	✓	✗
		Fuel Level 2 (%)	✓	✓	✗
		Fuel Level 3 (%)	✓	✓	✗
		Total Fuel	✓	✓	✗
		Total Fuel Flow	✓	✗	✗
		Total Engine Economy	✓	✗	✗
		Estimated Fuel Remaining	✓	✗	✗
		Estimated Distance to Empty	✓	✗	✗
		Estimated Time to Empty	✓	✗	✗
		Fuel Used (trip)	✓	✗	✗
		Fuel Used (season)	✓	✗	✗
Environment	Environmental-related data. For example, air temperature.	Pressure	✓	✗	✗
		Air Temperature	✓	✗	✗
		Set & Drift	✓	✗	✗
		App Wind Chill	✓	✗	✗
		True Wind Chill	✓	✗	✗
		Humidity	✓	✗	✗
		Dew Point	✓	✗	✗
		Sea Temperature	✓	✗	✗
GPS	GPS-related data. For example, vessel position.	Vessel Position	✓	✗	✗
		COG & SOG	✓	✗	✗
		COG	✓	✗	✗
		SOG	✓	✗	✗
Heading	Heading-related data. For example, locked heading.	Heading	✓	✗	✗
		Locked Heading	✓	✗	✗

Data Category	Description	Data Item	Digital	Dial	Graphical
Navigation	Types of data related to navigation. For example, bearing to waypoint.	Cursor Position (Only available in the Databar and data overlay.)	✓	✗	✗
		Cursor info	✓	✗	✗
		Cross Track Error	✓	✗	✗
		Rolling Road (Only available in the Data application.)	✗	✗	✓
		Compass	✗	✓	✗
		Target Position	✓	✗	✗
		Bearing to Waypoint	✓	✗	✗
		Distance to Waypoint	✓	✗	✗
		WPT TTG	✓	✗	✗
		Waypoint Info	✓	✗	✗
Pilot	Pilot-related data. For example, rudder.	Rudder	✓	✗	✗
Speed	Speed-related data. For example, VMG (Velocity Made Good) to Waypoint.	Speed	✓	✗	✗
		VMG to Waypoint	✓	✗	✗
Time	Time-related data. For example, local time.	Local Time	✓	✗	✗
		Local Date	✓	✗	✗
Wind	Wind-related data. For example, VMG (Velocity Made Good) to Windward.	TWS & TWA	✓	✗	✗
		AWS & AWA	✓	✗	✗
		GWS & GWD	✓	✗	✗
		VMG to Windward	✓	✗	✗
None					

Note: The engine data category shown above will contain one set of data items per engine.

Renaming a datapage

From the data application:

1. Select **Menu**.
2. Select **Edit Page**.
3. Select **Rename Page**.
The on screen keyboard is displayed.
4. Enter the new name for the datapage.
5. Select **SAVE**.

Adding a new datapage

You can add your own customized datapages to the data application. The total number of datapages including pre-configured pages is 10.

From the data application:

1. Select **Menu**.
2. Select **Create New Page**.
A list of available page layouts is displayed.
3. Select the required page layout.
The new page is displayed on screen.

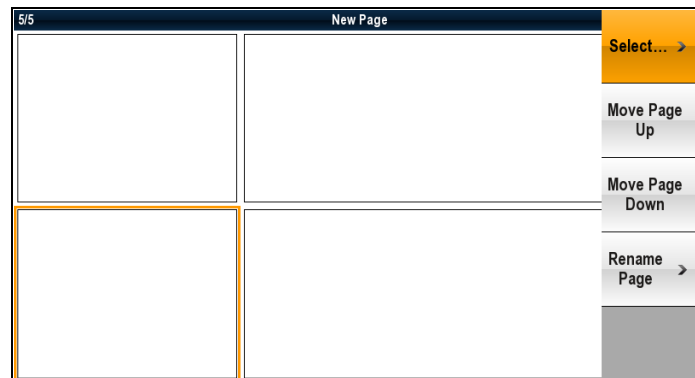

4. Select the blank cell on the new page layout that you want to add a data item to.
5. Select **Select Data Category**.
6. Select a data category.
Selecting a data category will display a list of data items for that category.

- Select the data item you want to display.
Once selected a tick will be placed next to the data item in the menu and the cell on screen will display the selected data item.
- Repeat steps 3 to 6 for all the data items you want to change.
- Select **Rename Page**.
The on screen keyboard is displayed.
- Enter the new name for the datapage.
- Select **SAVE**.

Deleting a datapage

You can delete custom or pre-configured datapages from the data application. The minimum number of datapages allowed is 1.

From the data application:

- Scroll to the datapage you want to delete.
- Select **Menu**.
- Select **Delete Page**.
The confirm delete pop up message is displayed.
- Select **Yes** to delete the datapage, or **No** to cancel the action.

Note: You cannot create a new engine page with the same layout as the pre-configured engine datapages.

Setting number of engines

You can set the number of engines your vessel has up to a maximum of 5.

From the data application:

- Select **Menu**.
- Select **Num. Of Engines**.
- Select either 1, 2, 3, 4 or 5.

Once selected, a tick will be placed next to the item in the menu and the engine datapage will be reset to display the correct number of engines.

Engine datapages

Depending on the number of engines you choose you will see one of the following datapages:

1 Engine	
2 Engines	
3 Engines	

4 Engines

5 Engines

Note: The default number of engines is determined by the vessel type selected during the initial start up wizard, if a sail boat is chosen then default is 1 engine for motor boats default is 2 engines.

Setting maximum engine RPM

You can set the maximum RPM range to display on the RPM data item.

From the data application:

- Select **Menu**.
- Select **Max RPM Range**.
A list of available RPM settings is displayed.
- Select the required RPM range.

A tick will be placed next to the selected RPM range in the menu and the RPM-range on the engine datapage will be changed to your new setting.

Example

1	Auto*
2	10,000 RPM

Note: *The maximum RPM when in auto mode is set by the engine.

Changing color theme and dial colors





You can change both the color theme and the dial color.

From the data application:

- Select **Menu**.
- Select **Presentation**.
- Select **Color Theme**.
Selecting color theme will switch color between Light and Dark.
- Select **Dial Color**.
Selecting dial color will switch the color between Light and Dark.

Datapage and dial colors

Datapage color theme and dial colors can be switched between light and dark.

Color Theme	Dial Color	Example
Light	Light	 A dashboard display with a light gray background and light-colored dials. The speedometer shows 40.1 and the tachometer shows 2.3.
Light	Dark	 A dashboard display with a light gray background and dark-colored dials. The speedometer shows 57.4 and the tachometer shows 1.2.
Dark	Dark	 A dashboard display with a dark gray background and dark-colored dials. The speedometer shows 55.8 and the tachometer shows 1.4.
Dark	Light	 A dashboard display with a dark gray background and light-colored dials. The speedometer shows 54.2 and the tachometer shows 2.3.

Resetting all datapages

You can reset the datapages in the data application to the factory defaults.

1. Select **Menu**.
2. Select **Reset All Pages**.
The confirm reset pop up message is displayed.
3. Select **Yes** to reset or **No** to cancel the action.

Note: Resetting all pages will restore your pre-configured pages to default settings and remove any custom pages that have been created. Number of engines and maximum RPM settings will not be changed during the reset.

SWIB

Chapter 17: Using the fuel manager

Chapter contents

- [17.1 Fuel manager overview on page 204](#)

SWIB

17.1 Fuel manager overview

The fuel manager provides an estimate of fuel remaining, and the distance and time which can be travelled before the tanks are empty. In order to calculate these values, you must configure the total capacity of fuel available to the engines and log each time you add fuel. The fuel manager also allows you to set a low fuel warning alarm which is sounded when the vessel's estimated fuel falls below a specified value.

The fuel manager page provides current calculation estimates and controls to enable use of the fuel manager feature.

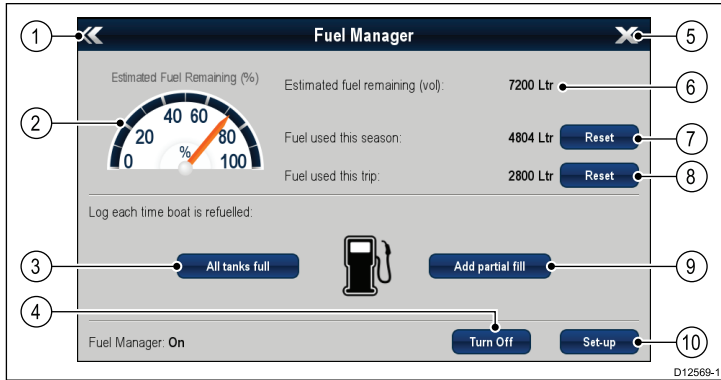

Item	Option	Description
1	Back	Back to System Set-up menu — New e Series only (For New c Series use the Back button).
2	Estimated fuel remaining (%)	Graphical representation of percentage of fuel remaining in the fuel tank(s).
3	All tanks full	Resets fuel remaining to full tank capacity.
4	Turn On/Off	Turn fuel manager On or Off.
5	Close	Back to Homescreen — New e Series only (For New c Series use the Home button)
6	Estimated fuel remaining (vol)	Volume of fuel remaining in the fuel tank(s).
7	Reset (Fuel used this season.)	Reset the fuel used this season to zero.
8	Reset (Fuel used this trip.)	Reset the fuel used this trip to zero.
9	Add partial fill	Specify fill amount by volume
10	Set-up	Specify settings for fuel manager.

In order to use the fuel manager you must:

- Connect a compatible engine interface to each engine you wish to monitor (to provide fuel flow rate data to the network).
- Enter the total fuel capacity of the vessel's fuel tanks.
- Turn on the fuel manager feature.
- Fill the fuel tanks to full.
- Select 'All tanks full'.
- Log each subsequent fuel fill whether partial or full.

Note:

Fuel manager estimates the amount of fuel onboard, based on the user logging each time you fill up, the total fuel capacity, and how much fuel is burned by the engine(s). Any incorrect entry could dramatically affect the estimated fuel usage and capacity which could result in a shortage of fuel. This system is not a substitute for other types of fuel calculations.

Total fuel onboard is an estimate and will be inaccurate if fuel fills are not entered, or fuel is used by other sources (e.g. generators etc.). Estimated distance and time to empty will be based on the fuel remaining calculation and values do not include weather/tide effects.

You should not rely on the fuel manager calculations for accurate voyage planning or in emergency and safety critical situations.

Enabling and disabling fuel manager

To turn the fuel manager on and off follow the steps below.

From the homescreen.

1. Select **Set-up**.
2. Select **Fuel Manager**.
3. Select **Turn On**, or **Turn Off**.

If the fuel manager is currently Off, **Turn On** is displayed. If the fuel manager is currently On, **Turn Off** is displayed.

Setting up fuel manager

To set up the required settings for the fuel manager follow the steps below.

With the Fuel Manager page displayed:

1. Select **Set-up**.
2. Select **Total Fuel Capacity**.
3. Adjust the value to represent your vessel's total fuel capacity.
4. Select **Back**.
5. Select **Economy Units**.

A list of available options is displayed:

- Distance per Volume
- Volume per Distance
- Litres per 100km

6. Select the required economy units.
7. Select **Back** to go back to the **Fuel Manager** page.

Fuel logging

You must ensure **all** fuel fills are recorded using the fuel manager.

From the fuel manager page:

1. When filling the tanks until full select **All tanks full**.
The estimated fuel remaining is reset to the value of your fuel tanks capacity.
2. When only partially filling the tank make a note of the volume of fuel added to the tank and then select **Add partial fill**.
3. Enter the value noted earlier this will be added to your current fuel remaining figure.

Note: It is recommended that you perform an 'All tanks full' fill up as regularly as possible as partial fills will cause a higher cumulative inaccuracy in the provided calculations.

Setting the low fuel alarm

Using the fuel manager also allows you to set a low fuel alarm which, if activated, is sounded when your vessel's remaining fuel falls to a specified value.

With the fuel manager turned on and set up correctly:

1. From the homescreen select **Set-Up**.
2. Select **Alarms**.
3. Select **Fuel manager**.
The low fuel alarm settings are displayed.
4. Select **Low Fuel** so that On is highlighted.
Selecting **Low Fuel** will turn the low fuel alarm On or Off.

5. Select **Fuel Level**.

The fuel level numeric adjust control is displayed.

6. Adjust the fuel level to the required value.

The low fuel alarm will now be sounded when the fuel remaining in the tank falls to the value specified.

Note: By default the low fuel alarm is switched off.

Resetting fuel used readings

You can reset the value of the fuel used this season or fuel used this trip by following the steps below.

From the fuel manager page:

1. Select **Reset** against fuel used this season, or
2. Select **Reset** against fuel used this trip.

The value is set to zero after **Reset** has been selected.

Note: Performing a Season reset automatically resets the trip value.

Fuel range rings

The fuel range ring gives an estimated range that can be reached with the estimated fuel remaining on-board.

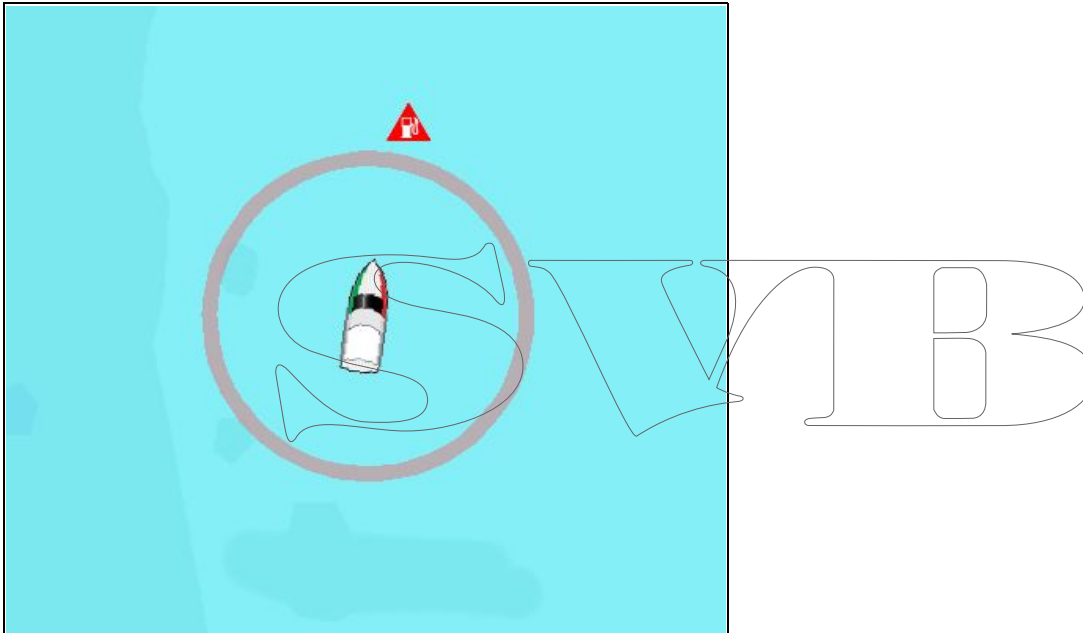

The fuel range ring can be displayed graphically in the chart application and indicates an estimated range that can be reached with the:

- Current rate of fuel consumption.
- Estimated fuel remaining on-board.
- Course remaining in a straight line.
- Current speed maintained.

Note:

The fuel range ring is an estimated range that can be reached at the current rate of fuel consumption, of the fuel onboard and based on a number of external factors which could either extend or shorten the projected range.

This estimate is based on data received from external fuel management devices, or via the Fuel Manager. It does not take into account prevailing conditions such as tide, current, sea state, wind etc.

You should not rely on the fuel range ring feature for accurate voyage planning or in emergency and safety critical situations.

Enabling and disabling fuel range ring

From the chart application, in 2D view:

1. Select **Menu**.

2. Select **Presentation**.

3. Select **Layers**.

4. Select **Fuel Range Ring**.

Selecting Fuel Range Ring will switch the function On and Off.

SWIB

Chapter 18: Using the weather application (North America only)

Chapter contents

- [18.1 Weather application overview on page 208](#)
- [18.2 Weather application set up on page 208](#)
- [18.3 Weather application display overview on page 209](#)
- [18.4 Weather map navigation on page 212](#)
- [18.5 Weather context menu on page 212](#)
- [18.6 Weather information on page 213](#)
- [18.7 Weather reports on page 213](#)
- [18.8 Animated weather graphics on page 214](#)
- [18.9 Weather application menu options on page 215](#)
- [18.10 Glossary of weather terms on page 216](#)

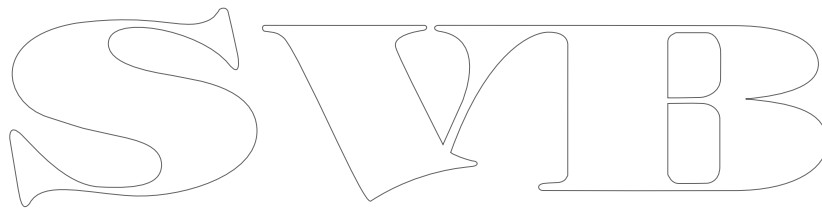

18.1 Weather application overview

The weather application overlays historical, live, and forecasted weather graphics on a world map.

The weather application can only be used in North America and its coastal waters.

The weather application graphics and their associated weather data enable you to determine the actual conditions in the vicinity of your vessel, or at a particular location.

Weather forecasts and warnings, detailing both current and predicted conditions, are regularly updated in the weather application.

Note: For types of warnings, watches, and advisories, refer to the NOAA website at www.nws.noaa.gov

Disclaimer — advisory only

The weather information is subject to service interruptions and may contain errors or inaccuracies and consequently should not be relied upon exclusively. You are urged to check alternate weather information sources prior to making safety related decisions. You acknowledge and agree that you shall be solely responsible for use of the information and all decisions taken with respect thereto. By using this service, you release and waive any claims against Sirius Satellite Radio Inc., WSI, Navcast Incorporated, and Raymarine with regard to this service.

If you do not have the subscription agreement, you may view a copy on the internet at www.sirius.com/marineweather

18.2 Weather application set up

A number of steps must be completed before you can use the weather application for the first time.

- Your multifunction display must be connected to a Raymarine Sirius weather receiver.
- Identify your Raymarine Sirius weather receiver's electronic serial number (ESN). This information can be obtained from the homescreen **Set-up** menu by selecting the device from the select devices page: **Set-up > Maintenance > Diagnostics > Select Device >**
- Using your ESN contact SiriusXM (www.siriusxm.com) to subscribe for Sirius Marine Weather (www.siriusxm.com/marineweather). When viewing the multifunction display's weather application, the ESN may be accessed from the following menu: **Menu > Sirius ESN.**
- You must be navigating within US coastal waters.
- Your multifunction display must obtain a GPS fix on your vessels location.
- You must specify the weather graphics that you want to display in the weather application.

Accessing the weather application

To access the weather application on your multifunction display follow the step below:

From the homescreen:



1. Select the **Weather** icon:

SVIB

18.3 Weather application display overview

The weather application displays a range of graphics to indicate weather conditions and forecast information.

The following diagram illustrates the main features of the weather application display:

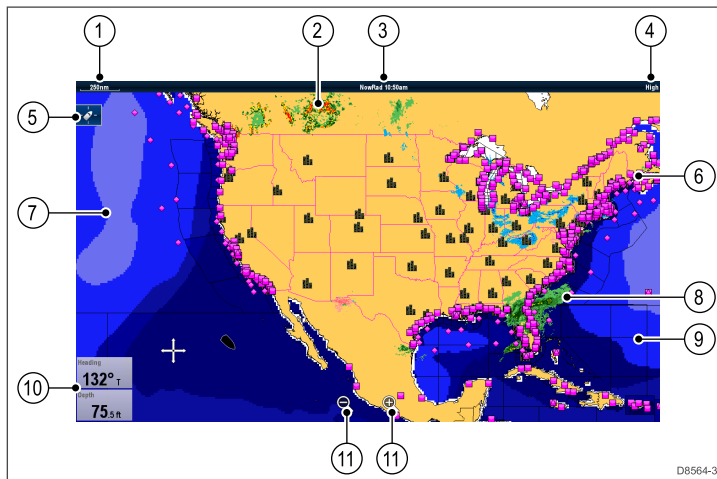

Item	Description
1	Range
2	Canadian radar
3	Animation and time / date
4	Signal strength
5	Find ship icon
6	Surface observation stations
7	Wave heights
8	NOWRad
9	Marine zones
10	Data overlay cells
11	On-screen Range in and out icons (Touchscreen displays only)

Weather symbols

The weather application uses a range of graphics and symbols to represent different weather conditions and forecasts.

Symbol	Description
	Storm cast (dark blue) arrows indicating direction and speed of a storm.
	Wave height <ul style="list-style-type: none"> • Highest waves (red) • Intermediate waves (greens) • Lowest waves (blues)
	Canadian radar (dark greens, yellow, orange and red)

Symbol	Description
	Lightning — a lightning symbol is shown at each cloud-to-ground strike: <ul style="list-style-type: none"> • Light (recorded in last 10–15 minutes.) • Medium (recorded in last 5–10 minutes.) • Dark (recorded in last 0–5 minutes.) More recent strikes are overlaid over older symbols.
	Wind — Wind symbols show the current wind direction and strength and can be displayed as either an arrow or a wind barb. Wind arrows indicate speed — the larger the arrow, the greater (stronger) the wind speed. Wind barbs give a more precise indication of wind speed as shown in the wind speed symbols section.
	Sea surface temperature (green, yellow and orange) <ul style="list-style-type: none"> • Blue — coldest • green • yellow • orange and red — warmest
	Surface observation stations (pink) — Current or historical weather data can be viewed at surface observation stations. Not all data is available for all stations.
	Cities — The city symbols enables you to access details of city weather forecasts. Up to 3 forecasts are displayed for each city.
	NOWRad <ul style="list-style-type: none"> • Rain (green, yellow and red.) • Snow (blues) • Mixture (pinks)

Storm tracking symbols

The weather application uses a range of symbols to represent different types of storm tracks. The storm tracking function enables you to monitor significant storms in the area.

Examples of significant storms include tropical disturbances, depressions, storms and cyclones, hurricanes, typhoons, and super typhoons.

The weather map displays the track that the storm has taken, its current and forecasted position, the wind radii (current position only), direction, and speed of travel.

Storm tracks are highlighted on the weather map in the form of symbols, as shown below.

Historical (grey)	Current (red)	Forecast (orange)	Description
			Hurricane (Category 1–5)
			Tropical storm
			Tropical disturbance, tropical depression

When a symbol is selected, additional storm information can be accessed by the context menu:

- Storm's name and type.
- Date and time.
- Position, direction and speed.
- Pressure and maximum wind speed and gusts.

Surface pressure symbols

The weather application uses a range of symbols to represent different surface pressure conditions.

Symbol	Description
	High / low pressure (blue and red)
	Warm front (red)
	Cold front (blue)
	Occluded front (purple)
	Stationary front (red-blue)
	Trough (brown)
	Squall line (red)
	Dry line (red)
	Isobars (grey)

Surface observation station symbols

The weather application uses a range of symbols to represent different types of surface observation station.

Symbol	Description
	Buoy station
	C-MAN (Coastal-marine automated network)
	WSI (Weather services international)
	NWS (National weather service)

Wind speed symbols

The weather application uses a range of symbols to represent different wind speeds.

Symbol	Speed	Symbol	Speed	Symbol	Speed
	3–7 kts		8–12 kts		13–17 kts
	18–22 kts		23–27 kts		28–32 kts
	33–37 kts		38–42 kts		43–47 kts
	48–52 kts		53–57 kts		58–62 kts
	63–67 kts		68–72 kts		73–77 kts
	78–82 kts		83–87 kts		88–92 kts
	93–97 kts		98–102 kts		etc.

Wave information symbols

The weather application uses a range of graphics and symbols to represent different types of wave information.

Symbol	Description
	Wave height — Waves are shown in 16 shades of color from: <ul style="list-style-type: none"> • Reds — Highest waves • Greens — Intermediate waves • Blues — Lowest waves
	Wave period — wave periods are shown using shades of blue, the darker the shade the shorter gap between successive waves. The wave period detail can be accessed by the context menu View Data option.
	Wave direction — direction of waves is indicated by blue arrows.

NOWRad precipitation color codes

NOWRad displays the type and level of precipitation:

Color code	Precipitation type	Reflectivity Intensity
Light green	Rain	(15 to 19 dBz)
Medium green	Rain	(20 to 29 dBz)
Dark Green	Rain	(30 to 39 dBz)
Yellow	Rain	(40 to 44 dBz)
Orange	Rain	(45 to 49 dBz)
Light red	Rain	(50 to 54 dBz)
Dark red	Rain	(55+ dBz)
Light blue	Snow	(5 to 19 dBz)
Dark blue	Snow	(20+ dBz)
Light pink	Mixed	(5 to 19 dBz)
Dark pink	Mixed	(20+ dBz)

Reflectivity Intensity	Rainfall (mm/hr)	Rainfall (in/hr)
90	15376.51	599.69
95	31575.91	1231.46
100	64841.98	2528.84
105	133154.6	5193.03
110	273436.4	10664.02

Selecting weather graphics

From the weather application:

1. Select **Menu**.
2. Select **Display Graphics**.
The display graphics list is displayed.
3. Select each graphic you want to Show or Hide.
4. Selecting a graphic will switch between Show or Hide.

Note: The Wind Vector graphic options are Arrow or Barb.

Canadian radar precipitation color codes

Canadian radar shows the intensity of precipitation for Canada. Unlike NOWRad, Canadian radar does not show the precipitation type.

Color code	Intensity in mm per hour
Transparent (nothing shown at very low precipitation)	0.00 to 0.20 mm/hr
Light green	0.21 to 1.00 mm/hr
Medium green	1.01 to 4.00 mm/hr
Dark green	4.01 to 12.00 mm/hr
Yellow	12.01 to 24.00 mm/hr
Orange	24.01 to 50.00 mm/hr
Light red	50.01 to 100 mm/hr
Dark red	100.01+ mm/hr

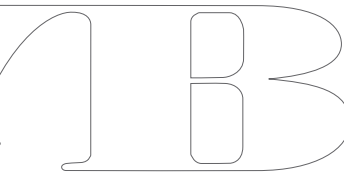

Reflectivity intensity to rainfall correlation

You can use the table below to correlate reflectivity intensity in dBz to estimated rainfall in millimeters per hour or inches per hour.

Reflectivity Intensity	Rainfall (mm/hr)	Rainfall (in/hr)
5	0.0749	0.0029
10	0.1538	0.0059
15	0.3158	0.0123
20	0.6484	0.0253
25	1.332	0.0519
30	2.734	0.1066
35	5.615	0.219
40	11.53	0.4497
45	23.68	0.9235
50	48.62	1.8963
55	99.85	3.8949
60	205.05	7.9975
65	401.07	15.6424
70	864.68	33.723
75	1775.65	69.252
80	3646.33	142.21
85	7487.83	292.03

18.4 Weather map navigation

You can move around the weather map and place waypoints.

When you open the weather application, a world map is displayed. If the system has a position fix for your vessel, the map will be centred on your location. As in the chart application, use the cursor to move around the map and view different locations, and the **Range Control** to zoom in and out. Use the **WPT** button to place waypoints.

Note: Waypoints are not displayed in the weather application, to view waypoints you will need to have an active chart application or radar application displayed.



Locating your vessel

The vessel icon can be repositioned to the center of the screen by following the steps below.

1. Select the Find Ship icon:  located on the left hand side of the screen.

18.5 Weather context menu

The weather application includes a context menu which provides positional data and the option to view weather reports from the cursor location.



The context menu provides the following positional data for the cursor location in relation to your vessel:

- Latitude
- Longitude
- Range
- Bearing

Depending on the item or location selected on screen the context menu provides the following options:

- **View Report** — Only available when a city is selected.
- **View Data** — Not available when a city is selected.
- **View Full Report** — Only available when an observation station is selected.

Accessing the context menu

You can access the context menu by following the steps below.

1. New e Series or New c Series:
 - i. Selecting a location, object or target on-screen and pressing the **Ok** button.
2. Touchscreen multifunction displays:
 - i. Selecting an object or target on-screen.
 - ii. Selecting and holding on a location on-screen.

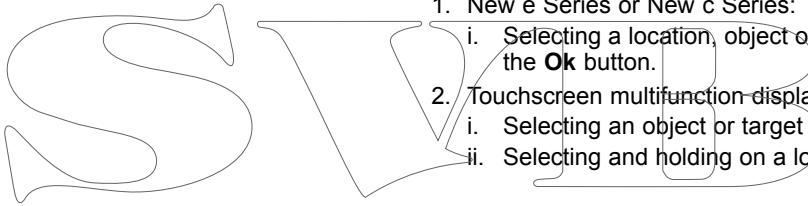

18.6 Weather information

You can view weather information for:

- a specific location
- a surface observation station (when displayed)
- Cities (when displayed)

Viewing weather data at a specific location

You can view weather details at a particular location on the world map regardless of the display graphics being shown in your weather application.

From the weather application:

1. Select the location you wish to view weather details for.
The context menu is displayed.
2. Select **View Data**.
A weather information page is displayed.

Weather information page

When selecting **View Data** from the weather context menu the following information is displayed:

- Zone description
- Zone ID
- Precipitation intensity
- Precipitation type
- Sea surface temperature
- Wind speed
- Wind form
- Wave height
- Wave period
- Wave direction

Viewing weather station reports

You can view surface observation station reports by following the steps below:

From the weather application, with surface observation stations displayed:

1. Select a surface observation station.
The weather context menu is displayed.
2. Select **View Full Report**.
The station report is displayed.

Station report

Surface observation station reports contain the following information (when available)

- Station ID, name, type, bearing, time and date
- Air temperature
- Visibility
- Sea pressure
- Wind speed and form
- Sea temperature
- Wave information

Viewing city weather forecasts

You can view weather forecasts for a particular city by following the steps below:

From the weather application, with cities displayed:

1. Select a city.
The weather context menu is displayed.
2. Select **View Report**.
The City forecast is displayed. Up to 3 forecasts are shown.

Using the weather application (North America only)

18.7 Weather reports

You can view a number of different weather reports to give you a comprehensive view of the weather.

Your multifunction display shows weather reports for:

- Tropical statements.
- Marine warnings.
- Marine zone forecasts.
- Watchbox warnings.

Tropical statements

Tropical statements provide information on tropical weather conditions. This information may not be available in all areas.

Marine warnings

You can display a report for the current marine warnings in the US coastal or near shore areas, or for the zone around your cursor or vessel.

Marine zone forecasts

These forecasts cover:

- US coastal weather forecasts, offshore forecasts and high seas forecasts, or
- Great lakes forecasts and near shore forecasts, or
- Canadian coastal weather forecasts.

Watchbox warnings

When a tornado or thunderstorm warning is received within the specified alert range of your vessel, the system generates a watchbox alert. This alert provides information on the type of warning and validity period. The full watchbox report text is also displayed.

Displaying weather reports

From the weather application:

1. Select **Menu**.
2. Select **View Report**.
3. Select either **Tropical Statements**, **Marine Warnings**, **Marine Zone Forecasts**, or **Watchbox Warnings**.

The relevant report, warning, or statement is displayed.

Changing the position of forecasts on the weather map

From the weather application:

1. Select **Menu**.
2. Select **View Report**.
3. Select **Report At**.

Selecting report at will switch between reports from Ship location or Cursor location.

Note: You cannot change the position of Tropical Statements or Watchbox Warnings.

Watchbox alert box

The watchbox alert box is a red polygon which shows the location where severe weather is occurring.

The watchbox alert box shall be displayed if the weather application is displayed, watchbox alerts are On and the watchbox alert area is within the specified range from your vessel, or set to All.

18.8 Animated weather graphics

You can view animated weather graphics to provide an indication of changing weather patterns.

The animated weather option enables you to view an animation from the current time for:

- NOWRad — weather radar
- Wind
- Waves
- Pressure — surface pressure

Running a weather animation

From the weather application:

1. Select **Menu**.
2. Select **Animate Weather**.
3. Select **Animate**.
A list of animation is displayed.
4. Select the type of animation from the list.
5. Select **Play** so the On is displayed.
Selecting play will switch between on and off.

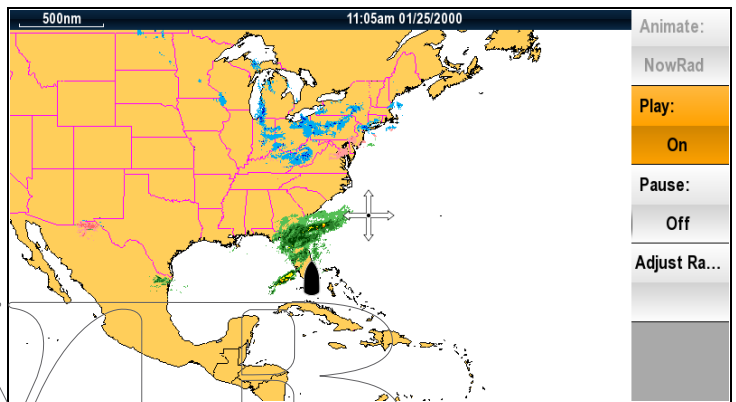

Note: You cannot display information (by moving the cursor over a symbol) when animation is running. The Range and Rotary controls do however remain operable provided the PAUSE option has not been selected. Ranging / panning will cause the animation to restart.

Note: The animation will be switched to Off if the animation menu is closed.

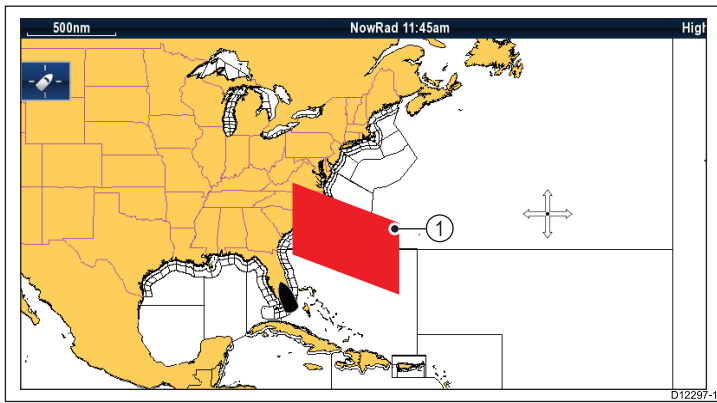

Item	Description
1	Watchbox alert box

Viewing watchbox alerts

You can view a watchbox alert at any time by following the steps below:

From the weather application with a watchbox alert box displayed.

1. Select the watchbox alert box.
The context menu is displayed.
2. Select **View Data**.
The watchbox alert message is displayed.

Setting watchbox alert range

You can specify the range from your vessel that you wish to receive watchbox alerts from.

From the weather application:

1. Select **Menu**.
2. Select **Watchbox Alerts**.
3. Select the required range, All, or Off if you do not want to receive watchbox alerts.
 - Selecting a range will display watchbox warnings occurring within the specified range.
 - Selecting All will display all watchbox warning regardless of range from your vessel.
 - Selecting Off will stop watchbox alerts.

Note: When the watchbox alert setting is set to Off watchbox reports will still be received but you will not be alerted.

18.9 Weather application menu options

The following options are available from the weather application menu:

Menu item	Description	Options
Find Ship	Selecting Find Ship will reset the display to show your vessel in the center of the screen.	
Display Graphics	The Display Graphics menu allows to choose what graphics to Show or Hide in the weather application.	Display Graphics <ul style="list-style-type: none"> • Canadian Radar • Cities • Lightning • Marine Zones • NOWRad • Sea Surface Temperature • Storm Cast • Storm Tracks • Surface Pressure • Surface Observation Stations • Wind • Wind Vector — Arrow or Barb • Watchbox • Wave Height • Wave Period • Wave Direction
Animate Weather	The Animate Weather menu contains the following sub-menus: <ul style="list-style-type: none"> • Animate • Play • Pause • Adjust Range 	Animate: <ul style="list-style-type: none"> • NOWRad • Wind • Wave • Pressure Play: <ul style="list-style-type: none"> • On • Off Pause: <ul style="list-style-type: none"> • On • Off Adjust Range Adjust Range allows you to use the Range Control to zoom in and out.
View Report	The View Report menu allows you to view the different types of weather reports received. You can also select the location of the report.	Report At <ul style="list-style-type: none"> • Ship • Cursor View Report <ul style="list-style-type: none"> • Tropical Statements • Marine Warnings • Marine Zone Forecasts • Watchbox Warnings

Menu item	Description	Options
Watchbox Alert	The Watchbox Alerts menu allows you to turn alerts Off, or select a range.	Alert Range <ul style="list-style-type: none"> • Off • 50 nm • 150 nm • 300 nm • 500 nm • All <div style="border: 1px solid black; padding: 2px;"> Note: Unit of measurement is dependant upon unit set-up choices. </div>
Data Overlay Set-up	Allows you to set up and display/hide up to 2 data cells in the bottom left corner of the screen:	<ul style="list-style-type: none"> • Data Cell 1 • Select Data Category • Data Cell 2 • Select Data Category Data Cell 1 <ul style="list-style-type: none"> • On • Off Select Data Category Allows selection of a data type by category. Data Cell 2 <ul style="list-style-type: none"> • On • Off Select Data Category Allows selection of a data type by category.
Sirius User ID	This option will display your registered Sirius User ID.	

18.10 Glossary of weather terms

Term	Definition
Cold front	The boundary between two different air masses where cold air pushes warm air out of the way and brings colder weather.
Cyclone	A large area of low atmospheric pressure, characterized by inward spiralling winds. A "low" also called a "depression". Also the name used for a hurricane in the Indian Ocean and Western Pacific.
Depression	An area of low pressure. Also called a cyclone.
Dry line	A region where there is a strong gradient in dew point temperatures. It is often found in a region where strong thunderstorms develop.
Forecast	Something that tells us what the weather is probably going to be like.
Front	The boundary between two masses of air with different temperatures (i.e. a mass of cold air and a mass of warm air).
High	Also known as an 'anticyclone' an area of high atmospheric pressure with a system of winds rotating outwards. This usually means dry weather. It is the opposite of a 'low'.
High Pressure	A mass of air that presses down strongly on the surface of the Earth because it is being cooled and is therefore more dense.
Hurricane	<p>A violent, spiralling storm that forms over the Atlantic Ocean, with winds over 120 kph. Such storms usually have a lifespan of several days. Also known as a typhoon or tropical cyclone. There are 5 levels of hurricane:</p> <ul style="list-style-type: none"> • Category 1 — Winds 74–95 mph (64–82 kt or 119–153 km/hr). Storm surge generally 4–5 ft above normal. No real damage to building structures. Damage primarily to unanchored mobile homes, shrubbery, and trees. Some damage to poorly constructed signs. Also, some coastal road flooding and minor pier damage. • Category 2 — Winds 96–110 mph (83–95 kt or 154–177 km/hr). Storm surge generally 6–8 feet above normal. Some roofing material, door, and window damage of buildings. Considerable damage to shrubbery and trees with some trees blown down. Considerable damage to mobile homes, poorly constructed signs, and piers. Coastal and low lying escape routes flood 2–4 hours before arrival of the hurricane centre Small craft in unprotected anchorages break moorings. • Category 3 — Winds 111–130 mph (96–113 kt or 178–209 km/hr). Storm surge generally 9–12 ft above normal. Some structural damage to small residences and utility buildings with a minor amount of curtain wall failures. Damage to shrubbery and trees with foliage blown off trees and large trees blown down. Mobile homes and poorly constructed signs are destroyed. Low lying escape routes are cut by rising water 3–5 hours before arrival of the centre of the hurricane. Flooding near the coast destroys smaller structures with larger structures damaged by battering from floating debris. Terrain continuously lower than 5 ft above mean sea level may be flooded inland 8 miles (13 km) or more. Evacuation of low lying residences with several blocks of the shoreline may be required. • Category 4 — Winds 131–155 mph (114–135 kt or 210–249 km/hr). Storm surge generally 13–18 ft above normal. More extensive curtain wall failures with some complete roof structure failures on small residences. Shrubs, trees, and all signs are blown down. Complete destruction of mobile homes. Extensive damage to doors and windows. Low lying escape routes may be cut by rising water 3–5 hours before arrival of the centre of the hurricane. Major damage to lower floors of structures near the shore. Terrain lower than 10 ft above sea level may be flooded requiring massive evacuation of residential areas as far inland as 6 miles (10 km). • Category 5 — Winds greater than 155 mph (135 kt or 249 km/hr). Storm surge generally greater than 18 ft above normal. Complete roof failure on many residences and industrial buildings. Some complete building failures with small utility buildings blown over or away. All shrubs, trees, and signs blown down. Complete destruction of mobile homes. Severe and extensive window and door damage. Low lying escape routes are cut by rising water 3–5 hours before arrival of the centre of the hurricane. Major damage to lower floors of all structures located less than 15 ft above sea level and within 500 yards of the shoreline. Massive evacuation of residential areas on low ground within 5–10 miles (8–16 km) of the shoreline may be required.
Isobar	A line on a weather map linking areas with equal air pressure.
Lightning	Discharge of static electricity in the atmosphere, usually between the ground and a storm cloud.
Low	Also called a 'depression' this region of low pressure can mean wet weather.
Low Pressure	A mass of air that presses down only weakly on the surface of the Earth's surface as it is warmed and it therefore less dense.
Millibar	A unit used to measure atmospheric pressure.
Occluded Front	An area where warm air is pushed upwards as a cold front overtakes a warm front and pushes underneath it.
Precipitation	Moisture that is released from the atmosphere as rain, drizzle, hail, sleet or snow, as well as dew and fog.
Pressure Centre	A region of high or low pressure.
Squall line	A non-frontal band, or line, of thunderstorms.
Super typhoon	A typhoon that reaches maximum sustained 1 minute surface winds of at least 65 m/s (130 kt, 150 mph). This is the equivalent of a strong category 4 or 5 hurricane in the Atlantic basin or a category 5 severe tropical cyclone in the Australian basin.
Tornado	A funnel shaped whirlwind which extends to the ground from storm clouds.
Tropical cyclone	A low pressure system that generally forms in the tropics. The cyclone is accompanied by thunderstorms and, in the Northern Hemisphere, a counterclockwise circulation of winds near the earth's surface.
Tropical depression	An organized system of clouds and thunderstorms with a defined surface circulation and maximum sustained winds of 38 mph (33 kt) or less.
Tropical storm	An organized system of strong thunderstorms with a defined surface circulation and maximum sustained winds of 39–73 mph (34–63 kt).
Tropics	An area on the Earth's surface that lies between 30° north and 30° south of the equator.
Trough	An elongated area of relatively low atmospheric pressure, usually extending from the centre of a low pressure region.
Typhoon	The name for a tropical storm originating in the Pacific Ocean, usually the China Sea. They are basically the same as the hurricanes of the Atlantic Ocean and the cyclones of the Bay of Bengal.

Term	Definition
Wave cyclone	A storm or low pressure centre that moves along a front.
Wave period	The period is the time gap between successive waves and the longer the period the faster the waves travel.

SWIB

SWIB

Chapter 19: Using the thermal camera application

Chapter contents

- [19.1 Thermal camera application overview on page 220](#)
- [19.2 Thermal camera image on page 220](#)
- [19.3 Controls overview on page 221](#)
- [19.4 Camera control on page 222](#)
- [19.5 Image adjustments on page 224](#)
- [19.6 Camera set-up menu on page 226](#)

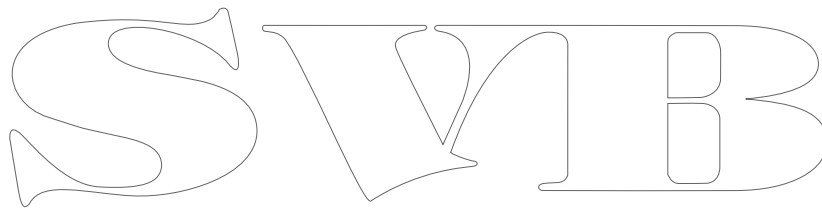

19.1 Thermal camera application overview

The thermal camera application enables you to control a connected thermal camera and display its image on your multifunction display.

Thermal imaging (also known as infrared) cameras enable you to see clearly in low-light and no-light conditions. For example, a thermal camera can help you navigate at night or identify obstacles in areas of low visibility or even total darkness.

The thermal application enables you to:

- **Control the camera:**
 - Pan.
 - Tilt.
 - Zoom (range).
 - Return camera to “home” (default) position.
 - Set the camera “home” position.
 - Pause the camera image.
 - Toggle between visible light and thermal camera lenses.
 - Toggle surveillance mode.
- **Adjust the camera image:**
 - Color palette.
 - Scene presets.
 - Brightness.
 - Contrast.
 - Color.
 - Video polarity (reverse video color).

Displaying the thermal camera application

With the home screen displayed:

1. Select a page icon that includes the thermal camera application. The thermal camera application is displayed.

Note: If the home screen does NOT include a page icon that features the thermal camera application you will need to create a new page icon featuring the thermal camera application.

19.2 Thermal camera image

The thermal camera provides a video image which is shown on your display.



The video feed provides:

- Thermal image
- Status icons / system information (e.g. camera direction and docking mode indicators in the example above).











You should take time to familiarize yourself with the thermal image. This will help you to make the most of your system:

- Consider every object you view in terms of how it will look “thermally” as opposed to how it looks to your eye. For example look for changes caused by the heating effect of the sun. These are particularly evident right after sunset.
- Experiment with white-hot and black-hot (reverse video) modes.
- Experiment by looking for hot objects (such as people) compared to the colder surroundings.
- Experiment with the camera for daytime viewing. The camera can provide improved daytime viewing in environments where traditional video camera performance suffers, such as in shadows or backlit scenes.

Thermal camera status icons

The thermal camera image includes icons to show the current status of the camera.

Icon	Description
	Camera direction indicator.
	Camera home position.
	Camera paused.
	Scene preset mode for night conditions.
	Scene preset mode for daytime conditions.
	Scene preset mode for night docking.
	Scene preset mode for identifying people or objects in the water.

Icon	Description
	Rear-view mode — image is flipped horizontally.
	Zoom setting: 2x zoom.
	Zoom setting: 4x zoom.
	Single active controller on network.
	Multiple active controllers on network.
	PC / laptop detected on network.
	Point mode enabled.
	Point mode disabled.
	Stabilization Off.
	Stabilization On.

FFC (Flat Field Correction)

Periodically the camera will perform a Flat Field Correction (FFC). This will fine tune the thermal image to suit the current ambient temperature.

The FFC operation is indicated by a momentary pause and a green rectangle displayed in the upper left of the thermal video image.

19.3 Controls overview

The thermal camera application is available on compatible Raymarine multifunction displays and systems. It includes controls for the thermal camera.

Thermal camera application – hardkey controls

Rotary control	Zoom image in / out.
Joystick / trackpad	<ul style="list-style-type: none"> • Pan and tilt camera <div style="border: 1px solid black; padding: 5px; margin: 5px 0;"> <p>Note: On touchscreen displays you can also use the touchscreen to pan and tilt the camera.</p> </div> <ul style="list-style-type: none"> • Navigate menus
OK	Confirm menu selection
CANCEL / Back	Cancel selection
RANGE IN / OUT	Zoom image in / out.

Thermal camera application menu.

The following menu options are available in the thermal camera application.

Activate Camera	Brings the thermal camera out of standby mode. (only available when camera is in standby.)
Pause Image	<ul style="list-style-type: none"> • On • Off (default)
Camera Home	Select to return the camera to its home position.
Image Options	Select to display the Image Options sub-menu. <ul style="list-style-type: none"> • Color • Scene • Thermal / Visible • Reverse video • Rear View • Surveillance
Adjust Contrast	Select to display the Adjust Contrast sub-menu. <ul style="list-style-type: none"> • Contrast • Brightness • Color
Standby	Select to place the camera in to standby mode. (only available when camera is activated.)
Camera Set-up	Select to display the Camera Set-up sub-menu. <ul style="list-style-type: none"> • Set Home Position • Slew Settings • Align Camera • Elev Align: • Surveillance Settings • Default Color • Icon Level • Stabilization Mode • Point Mode • Ball Down Mode • High Power Standby • High Power Torque

- JCU Icon
- PC Icon
- Restore Factory Defaults
- Calibrate Platform

Note: The thermal camera menu options available are dependant on the software version of your multifunction display and thermal camera. If options are different than listed above please refer to the manual that accompanied your thermal camera and / or the installation and operations handbook which accompanied your multifunction display.

19.4 Camera control

Power up and standby

When the breaker connecting power to the camera is switched on, the camera will run a boot up sequence lasting for about 1 minute, after which the camera will be in **Standby** mode.

In order for the camera to operate, you must bring the camera out of standby mode using the camera controls.

Thermal camera standby

Standby mode can be used to temporarily suspend the thermal camera's functions when the camera is not needed for a prolonged period.

When in standby mode the camera:

- Does NOT provide a live video image.
- Moves the camera into its "stowed" (parked) position (lens facing down into the camera base) to protect the camera optics.
- Engages its pan / tilt motors to hold the camera in place in rough seas.

Note: The "stowed" (parked) position can be configured using the camera's setup menu.

Enabling and disabling thermal camera standby

With the thermal camera application displayed:

1. Select **Menu**.
2. Use the **Standby** menu item to switch the camera in and out of standby mode.

Note: You can also use any of the camera controls in the thermal camera application to "wake" the camera from standby mode.

Pan, tilt and zoom

The camera controls allow for pan and tilt (elevation) of the camera, as well as zoom (magnification) of the thermal image.

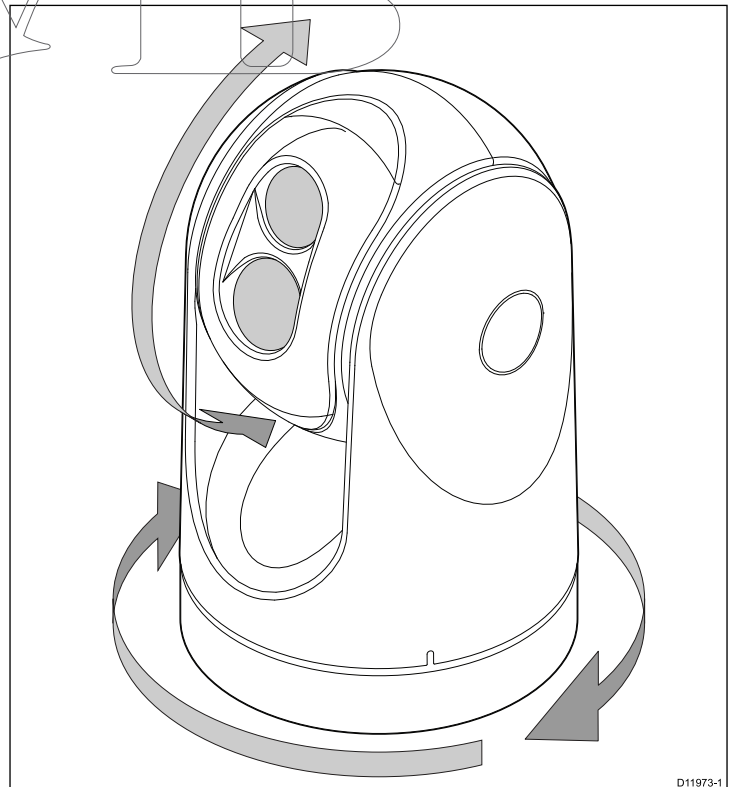

- Pan continuously through 360°.
- Tilt (elevate) to $\pm 90^\circ$ relative to the horizon.
- Zoom (magnify) the thermal camera image.

Note: Stabilized variants of the T-Series thermal cameras include a continuous zoom function, non-stabilized variants can switch between x2 and x4 magnification.



Panning and tilting, and the thermal image

On a New e Series multifunction display you can pan and tilt the thermal camera image using the touchscreen.

	Move your finger up and down the screen to tilt the camera up or down.
	Move your finger left and right on the screen to rotate the camera left or right (panning).

Thermal camera home position

The home position is a preset position for the camera.

The home position usually defines a useful reference point — for example, straight ahead and level with the horizon. You can set the home position as required and to return the camera to the home position at any time.

	The home icon appears on-screen momentarily when the camera returns to the home position. The icon flashes when a new home position is set.
--	---

Resetting the thermal camera to the home position

In the thermal camera application:

1. Select **Menu**.

2. Select **Camera Home**.

The camera returns to its currently defined home position, and the “Home” icon appears on-screen momentarily.

Setting the thermal camera home position

With the thermal camera application displayed:

1. Use the joystick or touchscreen to move the camera to the desired position.

2. Select **Menu**.

3. Select **Camera Set-up**.

4. Select **Set Home Position**.

The “Home” icon flashes on-screen to indicate that a new home position has been set.

Pausing the thermal camera image

With the thermal camera application displayed:

1. Select **Menu**.

2. Select **Pause Image**.

Thermal camera surveillance mode

In surveillance mode the camera pans left and right continuously.

The camera continues to pan until surveillance mode is disabled, or the camera controls are used to move the camera. When this occurs the camera does not automatically resume surveillance mode and the mode must be enabled again if required.

Enabling and disabling thermal camera surveillance mode

With the thermal camera application displayed:

1. Select **Menu**.

2. Select **Image Options**.

3. Use the **Surveillance** menu item to select the On or Off option, as appropriate.

Surveillance mode settings

The scan width and scan speed can be adjusted.

Scan Width

Using the thermal camera application

The scan width determines the distance that the camera pans left and right when in surveillance mode.

Scan Speed

The scan speed determines the speed at which the camera pans left and right when in surveillance mode.

Setting scan width

The surveillance mode scan width can be adjusted by following the steps below.

From the thermal camera application:

1. Select **Menu**.
2. Select **Camera Set-up**.
3. Select **Surveillance Settings**.
4. Select **Scan Width**.

The scan width options will be displayed:

- **Narrow** — The camera will scan approximately 20° left and right of the center (40° total).
- **Medium** — The camera will scan approximately 40° left and right of the center (80° total).
- **Wide** — The camera will scan approximately 80° left and right of the center (160° total).

5. Select the required option.

Setting scan speed

The surveillance mode scan speed can be adjusted by following the steps below.

From the thermal camera application:

1. Select **Menu**.
2. Select **Camera Set-up**.
3. Select **Surveillance Settings**.
4. Select **Scan Speed**.

The scan speed options will be displayed:

- **Slow**
- **Medium**
- **Fast**

5. Select the required option.

Thermal camera stabilization

The Raymarine T470SC and T473SC thermal cameras includes a mechanical stabilization feature.

The mechanical stabilization feature improves image stability by compensating for vessel motion and keeping the camera aimed at the point of interest. Mechanical stabilization has two aspects: horizontal (azimuth) and vertical (elevation). By default, mechanical stabilization is set to on, which provides the best on-the-water performance particularly when the vessel is underway and traveling on rough water or in swell conditions. You can disable or enable stabilization whenever you want. When you enable full stabilization (horizontal and vertical), the Stabilization On (no wave) icon flashes. It does not display continually, since this is the normal mode of operation. If you disable stabilization, the Stabilization Off (wave) icon remains on the screen to make you aware that the motion of the vessel can affect the camera performance. This is not a normal mode of operation. Stabilization is automatically turned off when the camera is stowed, but the system restores your setting when the camera is powered on. You can turn off the horizontal (pan) stabilization while retaining the tilt stabilization by enabling point mode.

Enabling / Disabling stabilization

Stabilization is enabled by default. You can enable or disable stabilization at any time by following the steps below.

From the thermal camera application

1. Select **Menu**.
2. Select **Camera Set-up**.
3. Select **Stabilization Mode**.

Selecting Stabilization mode switches stabilization On and Off.

Thermal camera point mode

Point mode is only applicable to thermal cameras which have mechanical stabilization.

Enabling point mode only has significance when stabilization is enabled. Enabling point mode turns off the horizontal (pan) stabilization while retaining the vertical (tilt) stabilization. This can be helpful when you want to use the thermal camera as an aide to navigation and keep the camera pointing in the same position relative to the vessel as it turns. For example, you may have stabilization enabled and have set the camera to point straight ahead relative to the front of the vessel. If the vessel is turned at a sharp angle under these conditions, the camera sensor will not follow the direction of the vessel. Enabling point mode keeps the camera in sync with the vessel direction while maintaining a stable elevation position. When point mode is enabled, a lock icon displays. The camera's azimuth position is now locked to the base. When you disable point mode, the unlock icon displays momentarily. The camera always starts up with point mode disabled.

Enabling / Disabling point mode

Point mode is disabled by default. With Stabilization enabled you can also enable point mode at any time by following the steps below.

From the thermal camera application:

1. Select **Menu**.
2. Select **Camera Set-up**.
3. Select **Point Mode**.

Selecting point mode switches point mode On and Off.

19.5 Image adjustments

Adjusting the thermal camera image





With the thermal camera application displayed:

1. Select **Menu**.
2. Select **Adjust Contrast**.
3. Select the Contrast, Brightness, or Color option as appropriate. The relevant numeric adjust control is displayed.
4. Adjust the value as required.
5. Select **Back** or **Ok** to confirm the new value.

Thermal camera scene presets

Scene presets enable you to quickly select the best image setting for the current environmental conditions.

During normal operation the thermal camera automatically adjusts itself to provide a high-contrast image optimized for most conditions. The Scene presets provide 4 additional settings that may provide better imagery in certain conditions. The 4 modes are:

	Night Running — scene preset mode for night conditions.
	Day Running — scene preset mode for daytime conditions.
	Night Docking — scene preset mode for night docking.
	Search — scene preset mode for identifying people or objects in the water.

Although the preset names indicate their intended use, varying environmental conditions might make another setting more preferable. For example, the night running scene preset might also be useful while in a harbor. You may find it beneficial to experiment with the different scene presets to discover the best preset to use for different conditions.

Changing the thermal camera scene preset

With the thermal camera application displayed:

1. Select **Menu**.
2. Select **Image Options**.
3. Use the **Scene** menu item to switch between the available scene presets, as appropriate.

Thermal camera color modes

A range of color modes are available to help you distinguish objects on-screen in different conditions.

Changing the color mode switches the thermal camera image between a greyscale mode and 1 or more color modes. There are 5 color modes available.

The factory default color mode is red, which may improve your night vision. This default mode can be changed if required using the camera's on-screen **Video Setup** menu.

Note: If you have the Disable Color Thermal Video option selected in the camera's on-screen **Video Setup** menu, only 2 color modes are available — greyscale and red.

Changing the thermal camera color mode

With the thermal camera application displayed:

1. Select **Menu**.
2. Select **Image Options**.
3. Use the **Colour** menu item to switch between the available color palettes, as appropriate.

Thermal camera reverse video

You can reverse the polarity of the video image to change the appearance of objects on-screen.

The reverse video option (video polarity) switches the thermal image from white-hot (or red-hot if the color mode setting is active) to black-hot. The difference between white-hot and black-hot is shown below:

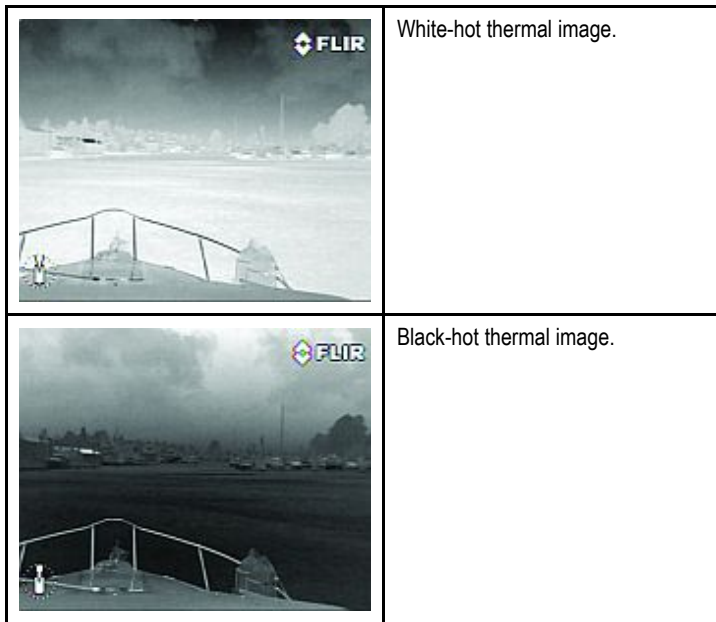

You may find it useful to experiment with this option to find the best setting to suit your needs.

Enabling thermal camera reverse video

With the thermal camera application displayed:

1. Select **Menu**.
2. Select **Image Options**.
3. Select **Reverse Video**.

Thermal and visible-light operation

“Dual payload” thermal cameras are equipped with 2 cameras — a thermal imaging (infrared) camera and a visible-light camera.

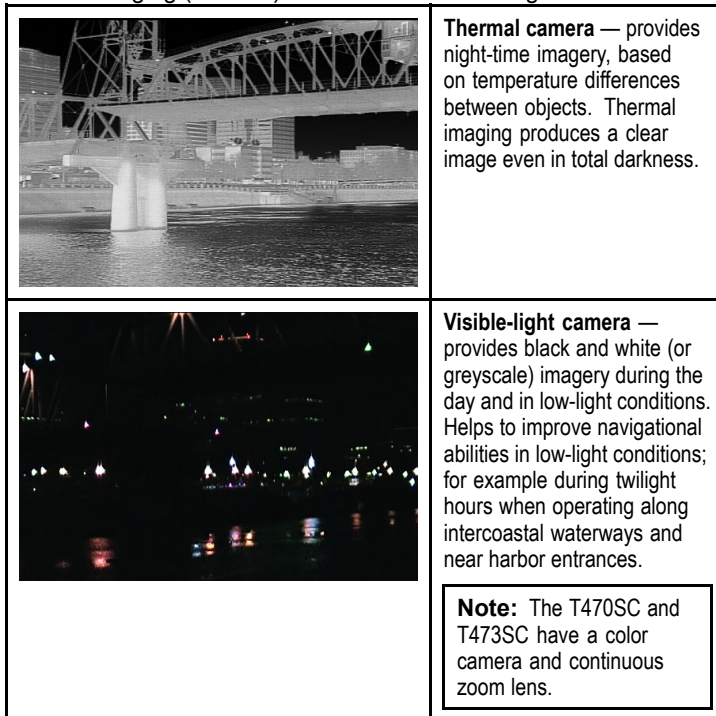

Switching between thermal and visible-light camera lenses

With the thermal camera application displayed:

1. Select **Menu**.
2. Select **Image Options**.
3. Use the **Image Type** menu item to switch between IR and Visible Light views, as appropriate.

Thermal camera rear view mode

The rear view mode flips the video image horizontally, providing a “mirror image”.

This is useful for example in instances where the camera is rear-facing and you are viewing the image on a forward-facing monitor.

Enabling thermal camera rear view mode

With the thermal camera application displayed:

1. Select **Menu**.
2. Select **Image Options**.
3. Select **Rear View**.

Slew to Cue

Slew to cue is a feature which maintains a selected position or object in the thermal camera's field of view. Slew to Cue options are available in the chart and radar applications as target context menu items.

Note: Heading data must be available on the system for Slew to Cue to work correctly.

For details on how to select a target to ‘slew to’ refer to the radar and chart sections of your manual.

The thermal camera can also automatically slew to:

- MOB target
- Dangerous AIS target
- Dangerous MARPA target

Options to enable or disable the automatic slew options are available in the thermal camera application

Setting the camera's height above sea level

To ensure that the thermal camera's alignment can be set correctly the height of the camera above sea level must be set.

From the thermal camera application:

1. Select **Menu**.
 2. Select **Camera Set-up**.
 3. Select **Slew Settings**.
- The Slew settings page is displayed.
4. Select **Camera height above sea level**.

The Camera height above sea level pop up is displayed.

5. Adjust the value to the required setting.

Aligning the thermal camera horizontally

If you find that slew to cue objects are consistently too far left or right on the screen then you can make fine adjustments to the camera's alignment by following the steps below.

From the thermal camera application:

1. Select **Menu**.
 2. Select **Camera Set-up**.
 3. Select **Align camera**.
- The Align camera to boat pop up is displayed.
4. Adjust the value to the required setting.

This value will adjust the camera's offset position to port or starboard.

Aligning the thermal cameras elevation

If you find that slew to cue objects are consistently too low or high on the screen then you can make fine adjustments to the camera's alignment by following the steps below.

From the thermal camera application:

1. Select **Menu**.
 2. Select **Camera Set-up**.
 3. Select **Elev Align**.
- The Align camera to boat pop up is displayed.
4. Adjust the value to the required setting.

This value will adjust the camera's offset position to port or starboard.

Enabling / disabling automatic slew to cue

From the thermal camera application:

1. Select **Menu**.

2. Select **Camera Set-up**.

3. Select **Slew Settings**.

The Slew settings page is displayed which includes the following auto slew options:

- Auto Slew to MOB
- Auto Slew to Dangerous AIS target
- Auto Slew to Dangerous MARPA target

4. Select the relevant option.

Selecting an option from the list will switch the auto slew option for that item On or Off.

19.6 Camera set-up menu

Set Home Position	Sets the camera's current position as the Camera Home position.	
Slew Settings	Provides automatic slew options and camera alignment settings.	<ul style="list-style-type: none"> • Auto Slew to MOB • Auto Slew to dangerous AIS target • Auto Slew to dangerous MARPA target • Camera height above sea level
Align Camera	Enables changes to camera's horizontal alignment.	
Elev Align	Enables changes to camera's elevation (vertical) alignment.	
Surveillance Settings	Enables you to set the speed and width the camera will scan when in surveillance mode.	<ul style="list-style-type: none"> • Scan Width • Scan Speed
Default Color	Enables selection of default color palette.	<ul style="list-style-type: none"> • Red • Greyscale • Glowbow • Rainbow • Fusion
Icon Level	Enables selection of level of icons displayed on-screen.	<ul style="list-style-type: none"> • None • Minimal • All
Stabilization Mode	Enables and disables stabilization mode. Note: Only available on stabilized variants of the T-Series cameras.	<ul style="list-style-type: none"> • On (default) • Off
Point Mode	Enables and disables point mode.	<ul style="list-style-type: none"> • On • Off (default)
Ball Down Mode	This options should be enables when the camera is mounted upside down in the 'ball down' configuration.	<ul style="list-style-type: none"> • On • Off (default)
High Power Standby	This option controls the amount of power used to hold the camera in position while it is in standby mode. With the setting enabled the camera will consume more power, but will help ensure that the camera is held in place in rough seas.	<ul style="list-style-type: none"> • On (default) • Off

SVP

High Power Torque	This option controls the amount of power used to hold the camera steady when in use. With the setting enabled the camera will consume more power, but will help ensure that the camera is held in place in rough seas. The High Power Torque mode may be useful for power boats that operate at higher speeds and experience high impact environments, and can accept higher power consumption.	<ul style="list-style-type: none"> • On (default) • Off
JCU Icon	Shows or hides the on-screen JCU connected icon.	<ul style="list-style-type: none"> • On (default) • Off
PC Icon	Shows or hides the on-screen PC connected icon.	<ul style="list-style-type: none"> • On (default) • Off
Restore Factory Defaults	Enables you to restore the camera's settings to factory default values.	
Calibrate platform	The calibrate platform option re-initializes the pan and tilt mechanism in the thermal camera.	

High power and high torque modes

Camera State	Camera setting	Dual payload	Single payload
Standby	<ul style="list-style-type: none"> • High Power Mode ON • High Torque Mode ON 	22 W	17.4 W
Standby	<ul style="list-style-type: none"> • High Power Mode OFF • High Torque Mode ON 	8 W	7.4 W
Standby	<ul style="list-style-type: none"> • High Power Mode ON • High Torque Mode OFF 	13 W	13 W
Awake	<ul style="list-style-type: none"> • High Power Mode OFF • High Torque Mode OFF 	8 W	7.4 W
Awake	<ul style="list-style-type: none"> • High Power Mode ON or OFF • High Torque Mode ON 	30 W	19.4 W
Awake	<ul style="list-style-type: none"> • High Power Mode ON or OFF • High Torque Mode OFF 	20 W	16.5 W

SWIB

Chapter 20: Using the camera application

Chapter contents

- [20.1 Camera application overview on page 230](#)

SWIB

20.1 Camera application overview

You can view a camera or a video feed which is connected directly to your multifunction display using the video input(s) or IP camera feeds which are available on your network.

The camera application can be set to cycle through all available feeds.

If supported by your camera, you can adjust the brightness, contrast, color and aspect ratio of the video image. PAL / NTSC is selected automatically.

The following image shows an example of a camera feed displayed in the camera application:



Note: Your multifunction display must be powered up before power is applied to any networked IP cameras, this is to enable your multifunction display to assign the IP camera(s) a valid IP address.

Note: If your IP camera(s) are not detected by your multifunction display, try power cycling the IP camera(s) whilst leaving your multifunction display powered up.

Note: For information on connecting the camera / video source and compatible video formats, refer to the *Cables and connections* section.



Changing the camera / video feed

On a New a Series or New e Series display, if more than 1 feed is available you can change which feed is displayed on the screen using touch.

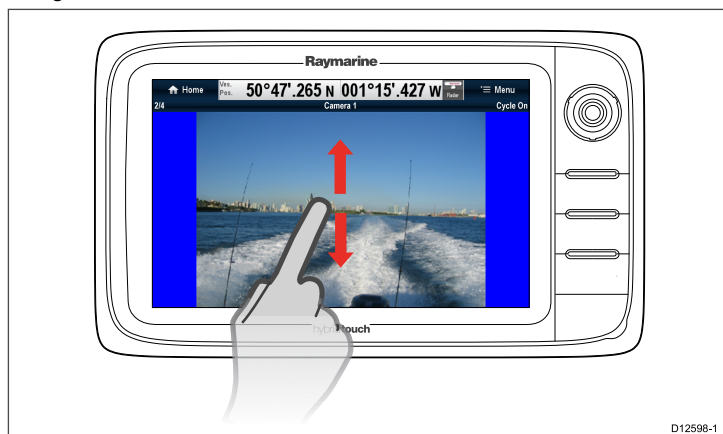

From the Camera application.

1. Touch and swipe your finger up to move to the next video feed.
2. Touch and swipe your finger down to display the previous video feed.



Changing the camera / video feed

On a New c Series or New e Series display, if more than 1 feed is available you can change which feed is displayed on the screen using the Joystick.

From the Camera application

1. Move the **Joystick Down** to display the next video feed.

2. Move the **Joystick Up** to display the previous video feed.

Changing the camera / video feed using the menu

On all display variants, when more than 1 feed is available, you can change which feed is displayed on the screen using the menu.

From the Camera application with a camera / video feed displayed:

1. Select **Menu**.
2. Select **Camera**.
3. Select the camera feed you want to display on the screen.

Camera cycling

When multiple camera / video feeds are available the camera application can be set up to automatically cycle through the available feeds at a specified time interval.

With camera cycling turned on the camera application will cycle through the available video input(s) on the display and available networked IP camera feeds. The feeds will be cycled in the order they appear in the Camera selection menu: **Menu > Camera**. Direct video input feeds will appear first and then any networked IP camera feeds. When the final feed in the list has been displayed the camera application will loop back to the first feed in the list.

Camera cycling will cycle through the multifunction displays available video input(s) even if no feed is connected to the input(s). Where no feed is present on a video input, during cycling the video input feed will appear as a blue screen. You can choose whether or not the video input(s) appear during camera cycling.

The time interval that each feed is displayed for, before switching to the next feed can be adjusted.

Turning on camera cycling

To turn on the camera cycling feature follow the steps below.

From the camera application:

1. Select **Menu**.
2. Select **Camera Cycling**.
3. Select **Camera Cycling** so that On is highlighted.

Selecting Camera Cycling will switch cycling On and Off.

The camera application will now cycle through all available feeds at the defined time interval.

Setting the time interval for camera cycling

The time interval that each video feed is displayed for can be set by following the steps below.

From the camera application, with Camera cycling turned on:

1. Select **Menu**.
2. Select **Camera Cycling**.
3. Select **Cycle interval**.
The cycle interval numeric adjust control is displayed.
4. Adjust the setting to the required time interval.

During camera cycling each feed is displayed for the time specified before changing to the next feed.

Showing or hiding video input feeds during camera cycling

By default your multifunction displays video input(s) are shown during cycling, even if no feed is connected to the input(s). You can choose whether video input(s) appear during camera cycling by following the steps below.

From the camera application:

1. Select **Menu**.
2. Select **Camera Cycling**.
3. Select the **Include <Camera Name>** option for the video input you want to Show or Hide.

Selecting **Include <Camera Name>** option will switch between showing or hiding the video input during camera cycling.

Note: In the steps above **<Camera Name>** represents the default feed name provided by the connected device or the custom name which can be assigned to the feed.

Turning off camera cycling

You can turn off camera cycling using the methods detailed below.

From the camera application, with camera cycling turned on:

1. Select **Menu > Camera Cycling > Camera Cycling** so that Off is highlighted, or
2. Change the camera / video feed manually as described earlier in this section, or
3. Press the **Back** button (applicable to New c Series and New e Series only).

Naming camera / video feeds

To aid selection of feeds you can name each feed.

From the Camera application:

1. Select the feed you want to name so that it is displayed on the screen.
2. Select **Menu**.
3. Select **Edit Name**.
The on-screen keyboard is displayed.
4. Enter the name you want the feed to be called.
5. Select **SAVE** to save the new name for the feed.

The name of the feed is displayed in the camera application's status bar.

Adjusting the video image

If supported by your connected camera / video input device or networked IP camera, you can adjust the video image.

With a video feed displayed in the camera application:

1. Select **Menu**.
2. Select **Contrast**, **Brightness**, or **Color**, as appropriate.
The numeric adjust control is displayed.
3. Adjust the level to the required setting.

Selecting the aspect ratio

If supported by your connected camera / video input device or networked IP camera, you can manually change the aspect ratio between 4:3 and 16:9.

From the camera application with a feed displayed:

1. Select **Menu**.
2. Select **Aspect ratio** so that 4:3 or 16:9 is selected as required.

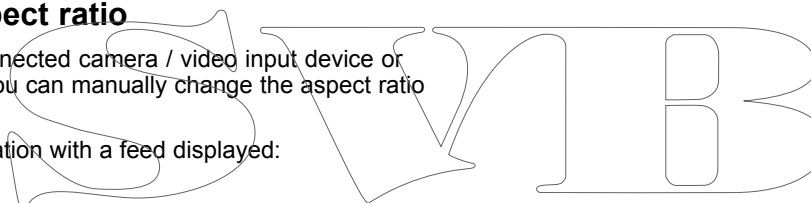

SWIB

Chapter 21: Using mobile applications

Chapter contents

- [21.1 Raymarine mobile apps on page 234](#)
- [21.2 Enabling Wi-Fi on page 235](#)
- [21.3 Enabling mobile apps on page 235](#)
- [21.4 Setting up Wi-Fi security on page 236](#)
- [21.5 Selecting a Wi-Fi channel on page 236](#)

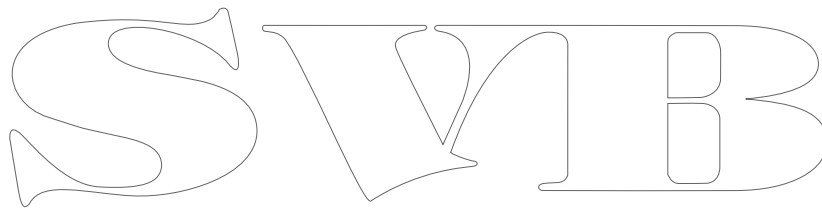

21.1 Raymarine mobile apps

Raymarine mobile apps enable viewing and control of your multifunction display via a compatible mobile device, using a Wi-Fi connection.

Raymarine currently offers the following mobile apps:

- **RayView**
- **RayRemote**
- **RayControl**

Note: Your multifunction display must have software version V3.15 or later in order to use mobile apps.

RayView

This app enables you to stream what you see on your multifunction display to a compatible smartphone or tablet device, using a Wi-Fi connection.

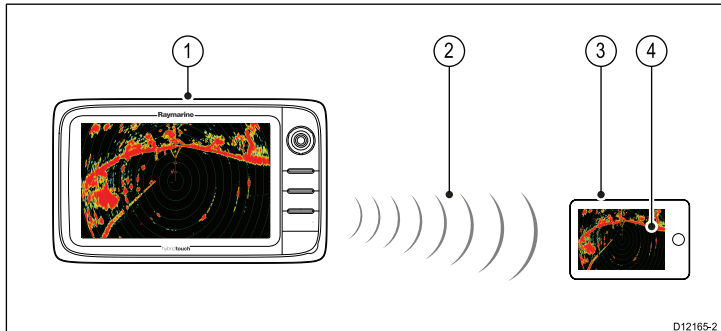

1. Multifunction display.
2. Wi-Fi connection (1 way – streaming only).
3. Compatible device.
4. “RayView” video streaming app.

RayControl

— This app enables you to stream and remotely control your multifunction display from a compatible tablet device, using a Wi-Fi connection.

Note: For safety reasons pilot controls and power button options are not available remotely.

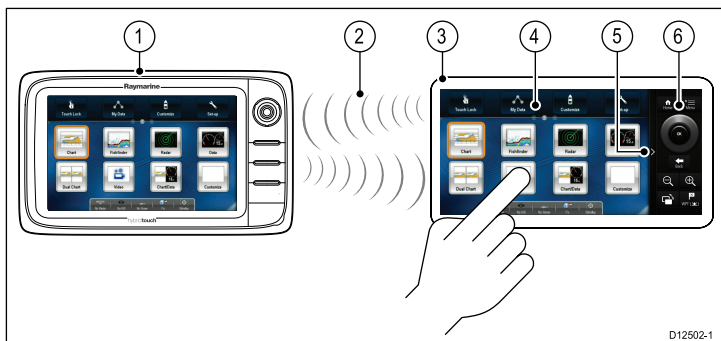

1. Multifunction display.
2. Wi-Fi connection (2 way – streaming and remote control).
3. Compatible tablet.
4. “RayControl” streaming and remote control app.
5. “RayControl” controls access (Touch the arrow to access controls).
6. “RayControl” remote controls

RayRemote

This app enables you to stream or control your multifunction display remotely from a compatible smartphone, using a Wi-Fi connection.

Note: RayRemote is able to switch between displaying the remote controls or the video stream.

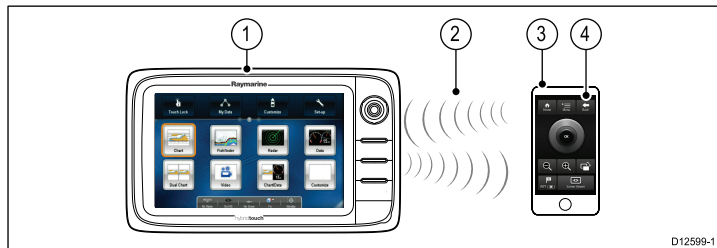

1. Multifunction display.
2. Wi-Fi connection (2 way – streaming or remote control).
3. Compatible smartphone.
4. RayRemote app

To use Raymarine mobile apps you must first:

- Download and install the required app from the relevant app store.
- Enable Wi-Fi in the System Settings on the multifunction display.
- Enable Wi-Fi on your compatible device.
- Select the Raymarine Wi-Fi connection from the list of available Wi-Fi networks on your compatible device.
- Enable the relevant type of connection (i.e. Viewing or Remote Control) in the System Settings on the multifunction display.

Mobile app compatibility

The Raymarine mobile apps are compatible with the following devices.

Device	Operating system
iPhone 4 or later	iOS
iPad 2 or later	iOS
Android smartphone	Android V2.2.2 or greater with 1GHz or greater processor
Android tablet	Android V2.2.2 or greater with 1GHz or greater processor
Kindle Fire	Android \ amazon

21.2 Enabling Wi-Fi

With the homescreen displayed:

1. Select **Set-up**.
2. Select **System Settings**.
3. Select **Wireless Connections**.
4. Select **Wi-Fi > ON**.

21.3 Enabling mobile apps

Raymarine mobile apps must be enabled on your multifunction display before you can stream video or remote control your multifunction display via a tablet or smartphone device.

With the homescreen displayed:

1. Select **Set-up**.
2. Select **System Settings**.
3. Select **Wireless Connections**.
4. Select **Mobile apps**.
5. Select **Viewing only** to enable video streaming only, or
6. Select **Remote Control** to enable remote control and video streaming using.
7. Launch the relevant Raymarine mobile app on your tablet or smartphone device and follow the on-screen instructions.

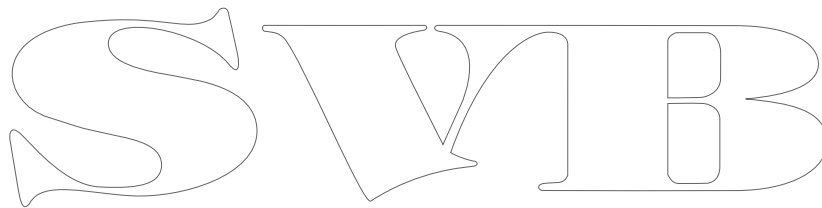

21.4 Setting up Wi-Fi security

You can encrypt the Wi-Fi connection on the multifunction display to prevent unauthorized devices from accessing the connection. The default encryption is WPA2.

With the homescreen displayed:

1. Select **Set-up**.
2. Select **System Settings**.
3. Select **Wireless Connections**.
4. Select **Wi-Fi > On**.
5. Select **Wi-Fi Name** and specify the SSID. This should be a memorable word and must be unique to each multifunction display in your system.
By default the SSID is the serial number of the multifunction display.
6. Select **Wi-Fi Security** and specify the type of encryption you want to use — None, WPA only, WPA 2 only (default), or WPA/WPA 2.

Note:

- Raymarine strongly recommends the use of the **WPA2** security setting.
- Selecting **None** for your WiFi Security will leave your WiFi open and allow anyone with a WiFi enabled device access to your system.

7. It is recommended that the default **WiFi Passphrase** is NOT changed.

Note: Once WiFi security is set up on the multifunction display you must specify the same SSID and password credentials on your iPhone or iPad before wireless video streaming can be used.

Changing the default passphrase

It is recommended that the default passphrase is not changed, however if you do need to change the passphrase follow the steps below:

From the Wireless Connections menu: **Set-up > System Settings > Wireless Connections**

1. Select **Wi-Fi Passphrase**.
The on-screen keyboard will be displayed, showing the current passphrase.
2. Use **DEL** to delete the current passphrase.
3. Enter a new passphrase.

Note: Ensure the passphrase you choose is 'strong' by using a combination of upper/lower case letters, numbers and special characters. The passphrase can be between 8 and 63 characters in length with longer passphrases being more secure.

4. Select **SAVE** to save the new passphrase.

21.5 Selecting a Wi-Fi channel

By default the multifunction display automatically selects an available Wi-Fi channel. If you're experiencing difficulties with wireless video streaming it may be necessary to manually specify a Wi-Fi channel for both the multifunction display and the device you want to stream video to.

With the homescreen displayed:

1. Select **Set-up**.
2. Select **System Settings**.
3. Select **Wireless Connections**.
4. Select **Wi-Fi > On**.
5. Select **Wi-Fi Channel**.
6. Select one of the listed channels.

Chapter 22: Media player application

Chapter contents

- [22.1 Media player connection on page 238](#)
- [22.2 Enabling Bluetooth on page 238](#)
- [22.3 Pairing a Bluetooth media player on page 239](#)
- [22.4 Enabling audio control on page 239](#)
- [22.5 !\[\]\(36f8637baaa56c4be44b454435949289_img.jpg\) Media player controls on page 240](#)
- [22.6 !\[\]\(b556e0ef1e10ccfc32976edb6416074f_img.jpg\) Media player controls using a remote control on page 240](#)
- [22.7 Unpairing a Bluetooth device on page 241](#)

SWIB

22.1 Media player connection

You can use your multifunction display to wirelessly control a Bluetooth-compatible media player (such as a smartphone).

The media player must be compatible with the Bluetooth AVRCP protocol (version 2.1 or higher).

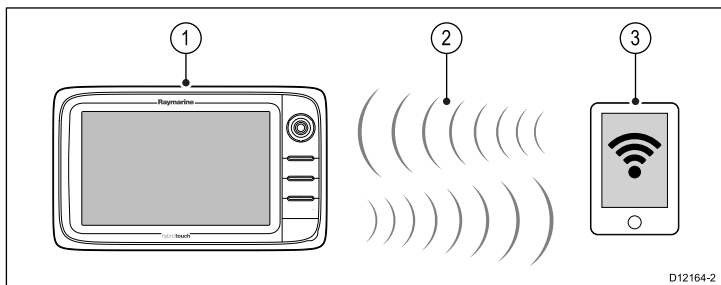

1. Multifunction display.
2. Bluetooth connection.
3. Bluetooth-compatible media player.

To use this feature you must first:

- Enable Bluetooth in the System Settings on the multifunction display.
- Enable Bluetooth on the media player device.
- Pair the media player device with the multifunction display.
- Enable Audio Control in the System Settings on the multifunction display.
- Connect an RCU-3 remote and assign the shortcut key to Start/Stop audio playback (Only required on a New c Series display).

Note: If your media player does not include built-in speakers it may be necessary to connect the media player's audio output to an external audio system or a pair of headphones. For more information refer to the instructions that accompany the media player device.

22.2 Enabling Bluetooth

With the homescreen displayed:

1. Select **Set-up**.
2. Select **System Settings**.
3. Select **Wireless Connections**.
4. Select **Bluetooth > On**.

22.3 Pairing a Bluetooth media player

With the homescreen displayed and Bluetooth turned on:

1. Select **Set-up**.
2. Select **System Settings**.
3. Select **Wireless Connections**.
4. Select **New Bluetooth Connection**.
A message is displayed prompting you to put your media player device into discovery mode.
5. Ensure Bluetooth is enabled on your external media player device and ensure it is ready to be paired. For more information, consult the instructions that accompany the device.
6. On the multifunction display, select **OK** in the message dialog.
The multifunction display will search for active Bluetooth devices.
7. Select **Stop Discovery** when your device appears in the list.
8. Select the media player device in the list.
A pairing request message is displayed on the external media device.
9. On the external media device, select Pair (or equivalent) to accept the pairing request message.
The multifunction display shows a message asking you to confirm the Pairing code.
10. If the pairing code displayed on the multifunction display matches the code displayed on the external media device, select **Ok** on the multifunction display. If the code does NOT match, repeat steps 4 to 8.
11. If the pairing was successful the multifunction display will confirm the pairing.
The external media device is now paired with the multifunction display.

22.4 Enabling audio control

With the homescreen displayed:

1. Select **Set-up**.
2. Select **System Settings**.
3. Select **Wireless Connections**.
4. Select **Connection Manager**.
5. Select the media player device in the list.
6. Select **Audio Control > On**.

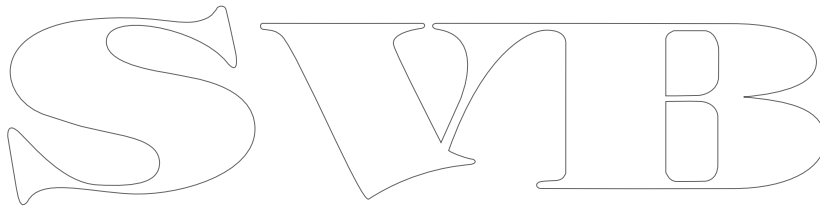

22.5 Media player controls

Touchscreen multifunction displays enable you to use the on-screen media player controls to control the audio playing on your external media player.



1. Touch this icon to display the audio controls.
2. Previous track.
3. Play track.
4. Pause track.
5. Next track.

Selecting **Back** will hide the audio controls.

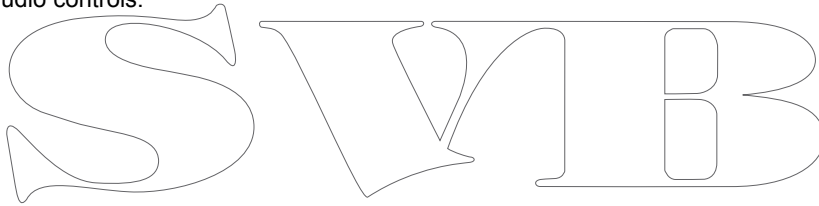

22.6 Media player controls using a remote control

You can control audio wirelessly using a Raymarine RCU-3 remote control unit.

The Shortcut key on the RCU-3 must be set to Start/Stop audio playback, refer to the *Using a Remote control* section for further details.

1. Press **UP** arrow for next track.
2. Press **DOWN** arrow for previous track.
3. Press **SHORTCUT** button to play/pause audio.

Note: On New c Series multifunction displays, whilst the audio controls appear on the screen you cannot interact with them. To control audio you must use a connected RCU-3.

22.7 Unpairing a Bluetooth device

If you are experiencing problems when attempting to use a Bluetooth device with the multifunction display it may be necessary to unpair the device (and any other paired Bluetooth devices) and then retry the pairing procedure.

With the homescreen displayed:

1. Select **Set-up**.
2. Select **System Settings**.
3. Select **Wireless Connections**.
4. Select **Connection Manager**.
5. Select the media player device in the list.
6. Select **Unpair / Forget this device**.

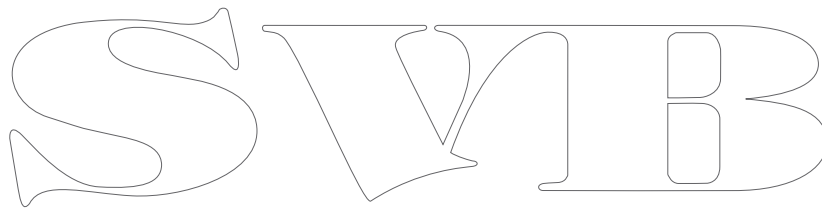

SWIB

Chapter 23: Using a remote control

Chapter contents

- [23.1 Remote control connection on page 244](#)
- [23.2 Pairing the remote and configuring the UP and DOWN buttons on page 244](#)
- [23.3 Operating principles on page 245](#)
- [23.4 Customizing the SHORTCUT button on page 245](#)
- [23.5 Remote control functions on page 246](#)
- [23.6 Reconnecting the RCU on page 247](#)

SWIB

23.1 Remote control connection

You can control the multifunction display wirelessly using a Raymarine remote control unit.

The remote control uses a Bluetooth wireless connection.

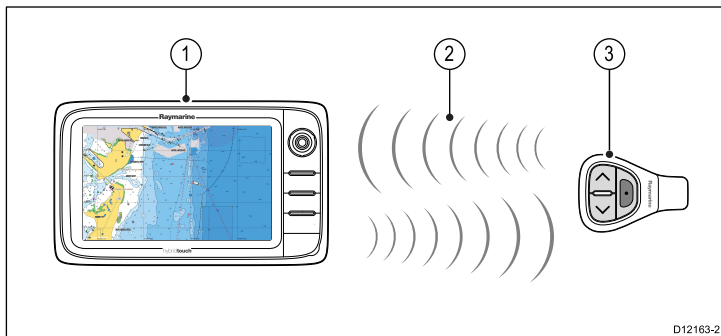

1. Multifunction display.
2. Bluetooth connection.
3. Raymarine Bluetooth remote control (for example, RCU-3).

To use the remote control you must first:

- Enable Bluetooth in the System Settings on the multifunction display.
- Pair the remote control unit with the multifunction display.

23.2 Pairing the remote and configuring the UP and DOWN buttons

The remote control unit must be “paired” with the multifunction display that you want to control. On your multifunction display, with the homescreen displayed:

1. Select **Set-up**.
2. Select **System Settings**.
3. Select **Wireless Connections**.
4. Select **Bluetooth > On**.
5. Select **New Bluetooth Connection**.

A pop-up message will be displayed to confirm that the device you are connecting to is discoverable.

6. Select **Ok** to confirm.

A list of discovered devices is displayed.

7. On your **remote control unit**, hold down the UP and DOWN buttons together for 10 seconds.
8. Select the remote control unit in the list of devices.
9. When prompted, press the arrow button on your remote that you wish to be configured as the UP button. The other arrow button will automatically be configured as the DOWN button.

If the pairing was successful a “Pairing Success” message will be displayed. If a “Pairing Failure” or “Pairing Timeout” message is displayed, repeat steps 1 to 8.

SVIB

23.3 Operating principles

Remote control operating principles.

- Only 1 multifunction display may be operated by a remote control unit at any one time. You cannot pair a multifunction display to more than 1 remote control at the same time.
- The 3 buttons on the remote control unit have different functions depending on the CONTEXT in which you are using it. For example, in the chart application the buttons control different functions than they do in the homescreen.
- All functions are accessed using a combination of the 3 buttons. For some functions you must press a button MOMENTARILY. You can also HOLD a button for continuous response (for example, continuous ranging in the chart application).
- The main methods of operation involve the use of the **UP** and **DOWN** “arrow” buttons to highlight different on-screen options. The **SHORTCUT** button is used to select (execute) them.
- During the pairing process you must define which of the arrow buttons you want to be the “UP” button.
- The **SHORTCUT** button is customizable and can be configured to operate one of a number of functions, using the System Settings menu on your multifunction display.

23.4 Customizing the SHORTCUT button

On your multifunction display, with the homescreen displayed:

1. Select **Set-up**.
2. Select **System Settings**.
3. Select **External Devices**.
4. Select **Remote Control**.
5. Select **Customize shortcut key**.
6. Select the function that you want to assign to the **SHORTCUT** key.

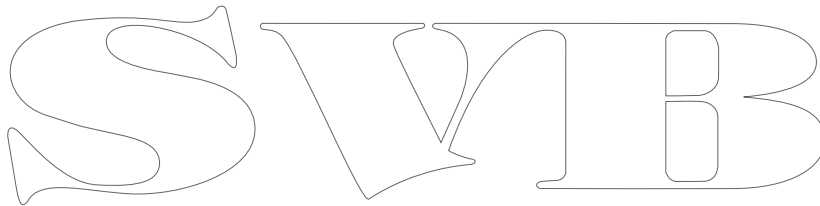

23.5 Remote control functions

Buttons

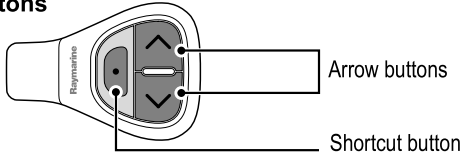

Range



Pair



Select

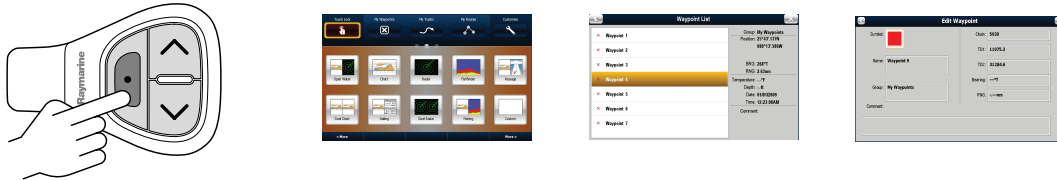

D12051-2

Default functions:	Button	Application where function available:				
		Chart	Radar	Fishfinder	Weather	Homescreen
Range / zoom.	<ul style="list-style-type: none"> Press UP or DOWN arrow for momentary response. Hold UP or DOWN arrow for continuous response. 	✓	✓	✓	✓	✗
Open homescreen.	Shortcut: Hold	✓	✓	✓	✓	✗
Select application in homescreen (in left-to-right, top-to-bottom order).	<ul style="list-style-type: none"> Press UP or DOWN arrow for momentary response. Hold UP or DOWN arrow for continuous response. 	✗	✗	✗	✗	✓
Toggle menu items and options in dialogs and prompts (in left-to-right, top-to-bottom order).	<ul style="list-style-type: none"> Press UP or DOWN arrow for momentary response. Hold UP or DOWN arrow for continuous response. 	✓	✓	✓	✓	✓
Place waypoint at vessel position.	Shortcut	✓	✓	✓	✓	✗
Media player control (requires a Bluetooth media player paired to the multifunction display).	<ul style="list-style-type: none"> Press UP / DOWN arrow for next / previous track. Press SHORTCUT button for play / pause. 	✓	✓	✓	✓	✓
Customizable functions:						
Open homescreen.	SHORTCUT	✓	✓	✓	✓	✗
Switch active application (only available when multiple applications are displayed).	SHORTCUT	✓	✓	✓	✓	✗

23.6 Reconnecting the RCU

1. When you pair the RCU-3 with a multifunction display a wireless connection is established.

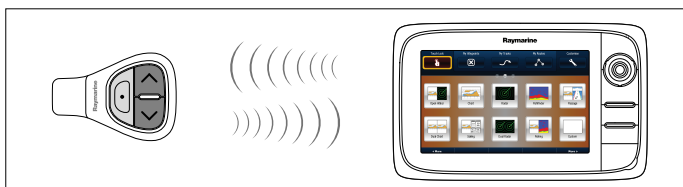

2. When you power off the multifunction display it loses its connection with the RCU-3 after 10 minutes.

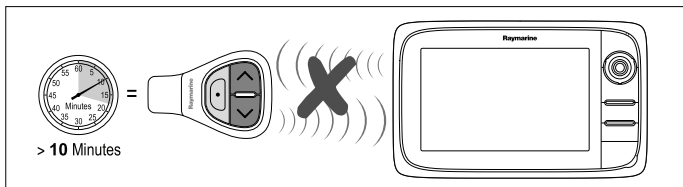

3. To restore the connection between the 2 units, press and hold any button on the RCU-3 for at least 3 seconds.

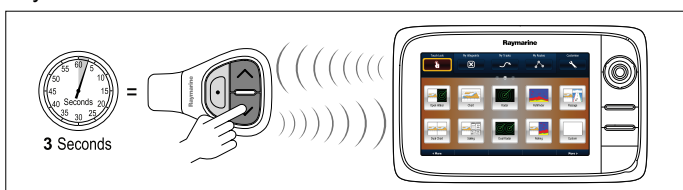

Note: You will also need to reconnect the RCU-3 as described above if you disable and then re-enable the Bluetooth connection on the multifunction display at any time.

SVIB

SWIB

Chapter 24: DSC VHF radio integration

Chapter contents

- [24.1 Using a DSC VHF radio with your display on page 250](#)
- [24.2 Enabling DSC VHF radio integration on page 250](#)

SWIB

24.1 Using a DSC VHF radio with your display

You can connect your DSC VHF radio to your multifunction display and show distress message information and GPS position data for other vessels.

Connecting a DSC VHF radio to your multifunction display provides the following additional functionality:

- **Distress Messages** — when your DSC VHF radio receives a DSC message or alarm from another DSC VHF radio-equipped vessel, the vessel identification (MMSI), GPS position, and time of distress message is displayed on your multifunction display. With the distress message displayed you can use the buttons provided to: clear the message, place a waypoint on the chart at the GPS position of the distressed vessel, or immediately start navigating (GOTO) to the GPS position of the distressed vessel.
- **Position Data** — the “Position Request” button on your DSC VHF radio enables you to send and receive GPS position data to and from other vessels equipped with a DSC VHF radio.

For information on installing and operating your DSC VHF radio, refer to the handbook that accompanies the radio.

The following image shows an example of a distress message displayed on a multifunction display:

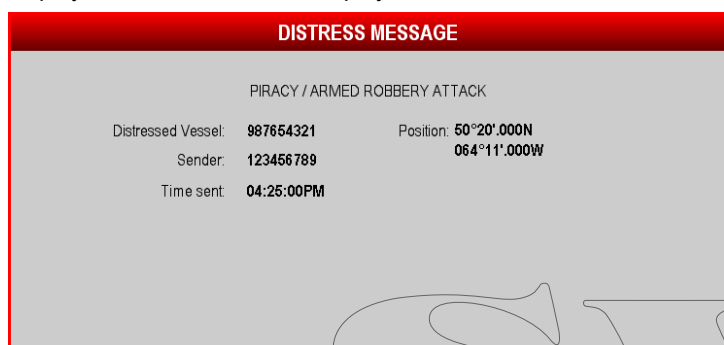

24.2 Enabling DSC VHF radio integration

With the homescreen displayed:

1. Select **Set-up**.
2. Select **System Settings**.
3. Select **DSC Alerts > ON**.

Note: DSC VHF distress messages are only displayed for radios connected via NMEA 0183. DSC VHF distress messages are NOT displayed for SeaTalk radios connected to the display via the SeaTalk to SeaTalkng converter.

Chapter 25: Customizing your display

Chapter contents

- [25.1 Language selection on page 252](#)
- [25.2 Boat details on page 253](#)
- [25.3 Units set-up on page 254](#)
- [25.4 Time and Date set-up on page 255](#)
- [25.5 Display preferences on page 256](#)
- [25.6 Data cell and databar customization on page 258](#)
- [25.7 System set-up menus on page 262](#)

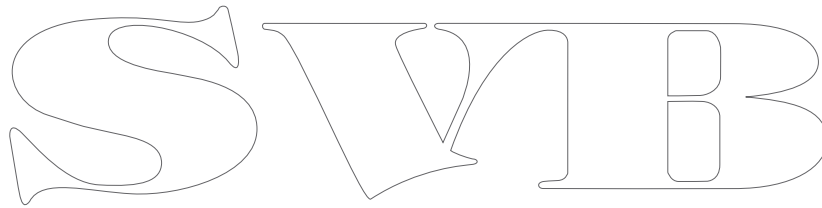

25.1 Language selection

The system can operate in the following languages:

English (US)	English (UK)	Arabic
Chinese	Croatian	Danish
Dutch	Finnish	French
German	Greek	Italian
Japanese	Korean	Norwegian
Polish	Portuguese (Brazilian)	Russian
Spanish	Swedish	Turkish

With the homescreen displayed:

1. Select **Customize**.
2. Select **Language**.
3. Select from the languages available.

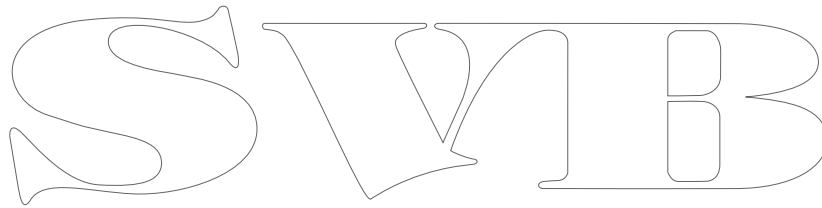
A large, stylized outline logo consisting of the letters 'S', 'W', 'I', and 'B' in a bold, rounded font. The letters are white with a black outline, set against a plain white background.

25.2 Boat details

You can customize various aspects of the display's functions to make them specific to your vessel.

Menu item	Description	Options
Boat Type	<p>You can change the appearance of the vessel in the chart application. Select the option that most closely resembles the type and size of your vessel.</p> <div style="border: 1px solid black; padding: 5px;"> <p>Note: When boat type is selected during the initial set up of the multifunction display the boat type shall determine the datapage configuration in the data application.</p> </div>	<ul style="list-style-type: none"> • Power Cruiser 1 (default) • Power Cruiser 2 • Power Cruiser 3 • Inboard Speed Boat • Outboard Speed Boat • Workboat • RIB • Sail Cruiser • Race Sail • Catamaran • Sport Fishing • Pro Fishing
Minimum Safe Depth	<p>Allows you to specify the hull clearance required by your vessel. Hull clearance information is used by the tide graphs in the chart application to display the times at which the tide will go above or below a safe depth for your vessel's hull. If the tidal water depth is too low for your hull you risk damaging or grounding your vessel.</p> <div style="border: 1px solid black; padding: 5px;"> <p>Note: Raymarine recommends adding some contingency from the actual hull clearance to the value selected.</p> </div>	<ul style="list-style-type: none"> • 1.0 to 33.0 (if Depth Units preferences set to Feet) • 0.5 to 10.0 (if Depth Units preferences set to Meters) • 0.1 to 5.0 (if Depth Units preferences set to Fathoms)
Total Fuel Capacity	<p>Allows you to specify the total fuel capacity of your vessel, this is required in order to enable the fuel manager function.</p>	

Customizing the vessel icon

With the homescreen displayed:

1. Select **Customize**.
2. Select **Boat Details**.
3. Select **Boat Type**.
4. Select the icon that most closely resembles your vessel type and size.

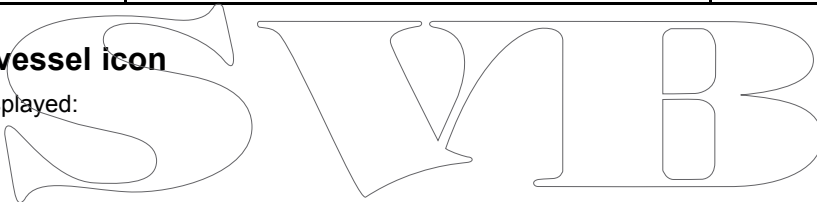

Setting the vessel minimum safe depth

With the homescreen displayed:

1. Select **Customize**.
2. Select **Boat Details**.
3. Select **Min. Safe Depth**.
4. Adjust the setting as appropriate.

Note: The units for the depth measurement are based on those specified in the **Homescreen > Customize > Units Set-up > Depth Units** menu.

25.3 Units set-up

You can specify your preference for the units of measurement that will be used in all applications.

Menu item	Description	Options
Distance Units	The units of measure that will be used in all applications for the display of all values related to distance.	<ul style="list-style-type: none">• Nautical Miles• Statute Miles• Kilometers
Speed Units	The units of measure that will be used in all applications for the display of all values related to speed.	<ul style="list-style-type: none">• Knots• MPH (Miles Per Hour)• KPH (Kilometers Per Hour)
Depth Units	The units of measure that will be used in all applications for the display of all values related to depth.	<ul style="list-style-type: none">• Feet• Meters• Fathoms
Temperature Units	The units of measure that will be used in all applications for the display of all values related to temperature.	<ul style="list-style-type: none">• Fahrenheit• Celsius
Pressure Units	The units of measure that will be used in all applications for the display of all values related to pressure.	<ul style="list-style-type: none">• Bar• PSI• Kilopascals
Volume Units	The units of measure that will be used in all applications for the display of all values related to volume.	<ul style="list-style-type: none">• US Gallons• Imperial Gallons• Litres

Specifying preferred units of measurement

1. Select **Customize**.
2. Select **Units Set-up**.
3. Select the type of measurement you want to change (for example, Distance Units).
4. Select the preferred type of unit (for example, Statute Miles).

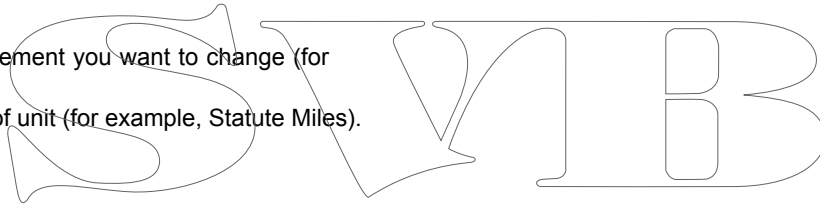

25.4 Time and Date set-up

You can specify your preference for the way that time and date will appear in all applications.

Menu item	Description	Options
Date Format	Allows you to specify the preferred format for the display of date information in all applications.	<ul style="list-style-type: none">• MM:DD:YY (Month, Day, Year)• DD:MM:YY (Day, Month, Year)
Time Format	Allows you to specify the preferred format for the display of time information in all applications.	<ul style="list-style-type: none">• 12hr• 24hr
Local Time: UTC	Allows you to specify the local time zone that will be used, in terms of an offset from UTC (Universal Coordinated Time), in 0.5 hour increments.	<ul style="list-style-type: none">• -13 to +13 hours (in 0.5 hour increments)

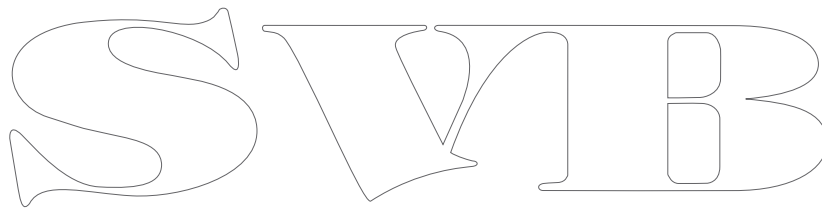
The image shows the letters 'S', 'W', and 'B' in a large, stylized, outlined font. The 'S' is on the left, the 'W' is in the middle, and the 'B' is on the right. The letters are white with a black outline and are set against a plain white background.

25.5 Display preferences

You can specify your preference for general display behavior.

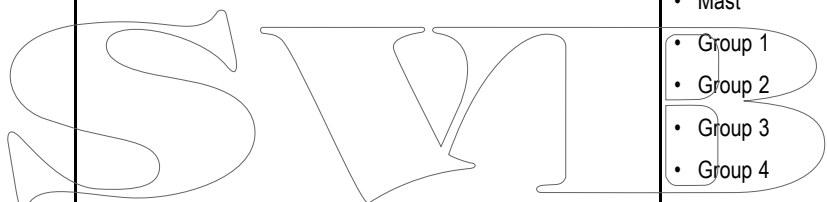
Menu item	Description	Options
Key Beep	An audible sound can be made each time a button is pressed or the touchscreen is used.	<ul style="list-style-type: none"> • ON (default) • OFF
Cursor Autohide	If set to On, the cursor will be automatically hidden after a period of no movement. If set to Off, the cursor will persist on the screen until moved.	<ul style="list-style-type: none"> • ON • OFF (default)
Range Controls	<p>On a New e Series display you can specify whether the Chart, Radar and Weather application display the on-screen range in and range out icons.</p> <div style="border: 1px solid black; padding: 5px;"> <p>Note:</p> <ul style="list-style-type: none"> • On-screen range controls are not available on a New c Series display. • On-screen range controls cannot be hidden on a New a Series display. </div>	<ul style="list-style-type: none"> • Show (default) • Hide
Shared Brightness	<p>You can set up shared brightness groups (or “zones”) to adjust the brightness on multiple units simultaneously.</p> 	<p>Share Brightness</p> <ul style="list-style-type: none"> • ON (default) • OFF <p>Brightness Group</p> <ul style="list-style-type: none"> • Helm 1 (default) • Helm 2 • Cockpit • Flybridge • Mast • Group 1 • Group 2 • Group 3 • Group 4 • Group 5
Screenshot File	<p>Enables you to specify the default SD card slot for screen capture images.</p> <div style="border: 1px solid black; padding: 5px;"> <p>Note: This option is not available on New a Series displays.</p> </div>	<ul style="list-style-type: none"> • MicroSD 1 • MicroSD 2

On-screen range controls

You can enable and disable on-screen range controls on a New e Series display by following the steps below.

From the homescreen:

1. Select **Customize**.
2. Select **Display Preferences**.
3. Select **Range Controls**.

Selecting Range Controls will switch between showing and hiding the on-screen range controls.

Once compatible units are added to a shared brightness group, any brightness adjustment made to any of the units in the group is also reflected in all other units in that group. An on-screen single brightness control is available for controlling any units in the brightness group:

Shared brightness

You can set up shared brightness groups to adjust the brightness on multiple units simultaneously.

The following units are compatible with shared brightness groups:

- New c Series multifunction displays.
- New e Series multifunction displays.
- i50
- i60
- i70
- p70 / p70R pilot controllers
- ST70
- ST70+

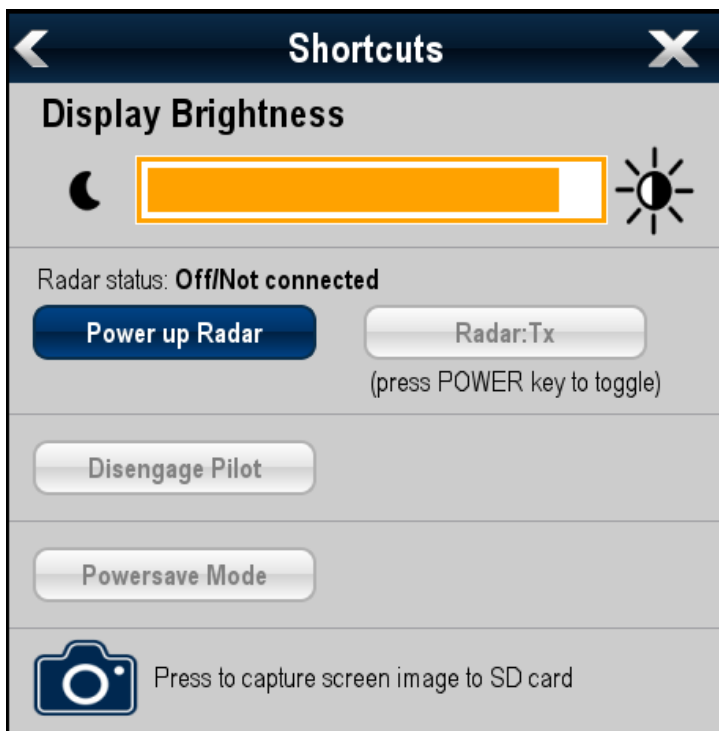

Multiple brightness groups can be configured. This can reflect the physical location of the units on your vessel if required. For example, the units at your helm can be set to one group, and the units on the flybridge can be set to a different group. In this example, any brightness adjustments made to a unit at the helm would be automatically reflected in the other units at the helm but not on the flybridge.

The shared brightness function requires the following:

- All units must be compatible with the shared brightness function (see list of compatible units above).
- Before a unit can respond to a shared brightness adjustment it must be assigned to the relevant **Brightness Group**.
- A single unit can only belong to one brightness group at any one time.
- The **Share brightness** setting must be set to On for all units in the brightness group.
- When setting up a brightness group an initial **Sync brightness** operation must be performed, with all the displays in that group powered on, to configure the display brightness of all units in the group.

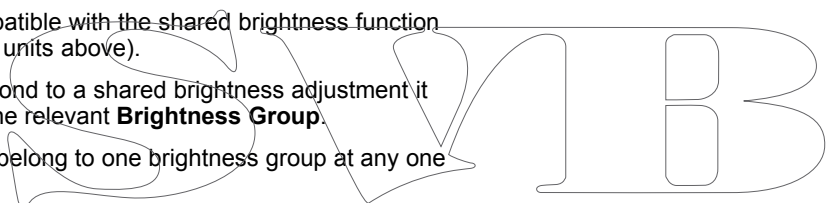

Setting up shared brightness

With the homescreen displayed:

1. Select **Customize**.
2. Select **Display Preferences**.
3. Select **Shared Brightness**.
4. Select the On option for the **Shared brightness** menu item.
5. Select **Brightness Group**.
6. Select an appropriate brightness group.
7. Repeat the process for the other displays you want in the brightness group. If the display is not a multifunction display, refer to the documentation that accompanies the unit for instructions on setting-up shared brightness.
8. Once all required displays have been added to the same brightness group, select **Sync Brightness** on the multifunction display.
A shared brightness message is displayed.
9. Ensure all displays in the brightness group are powered on.
10. Select **Sync**.

When completed a message is displayed confirming that shared brightness has been configured.

Once shared brightness has been successfully configured, changing the brightness of any display in that brightness group will automatically change the brightness of all displays in that group.

25.6 Data cell and databar customization

You can customize the data displayed in on-screen cells with a wide range of data.

Customizable data is displayed in the databar, extended databar (HybridTouch displays only) or data cells areas of the screen.

The databar, extended databar and data cells are available in all applications.

The 3 areas of the screen where customizable data is displayed are illustrated and described below:

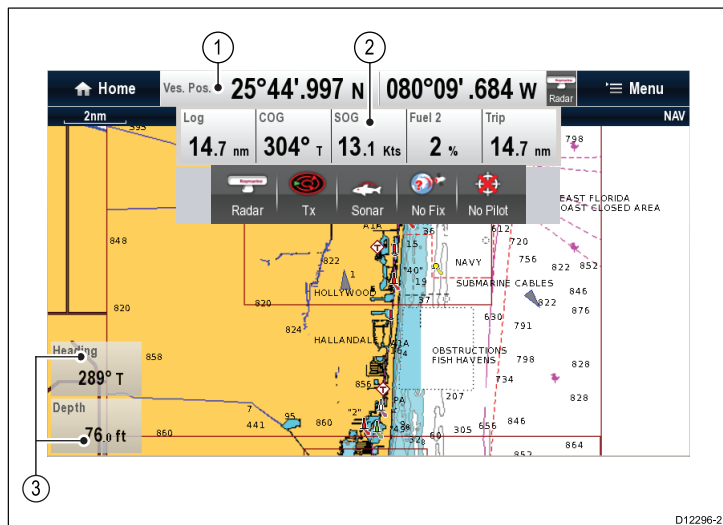

1. **Databar** — permanently displayed at the top of the screen in the chart, radar, fishfinder, and weather applications. The databar contains data cells that can be customized to display data from a wide range of categories.
2. **Expanded Databar** — (HybridTouch displays only) displayed when you touch the databar. Additional data cells can be displayed, from a wide range of data categories. The expanded databar is displayed until the screen is touched again. You can display the status icons below the expanded databar. This provides status information for external equipment:
3. **Data overlay cells** — up to 2 data cells can be displayed. Each cell can display one item of data from the available data categories. Data is displayed on-screen permanently.

Displaying status icons in the databar

Touchscreen multifunction displays enable you to display status icons in the databar.

From the homescreen:

1. Select **Customize**.
2. Select **Databar Set-up**.
3. Select **Status Icon Bar** so that On is highlighted.

The status icons are now displayed below the expanded databar.

Customizing data overlay cells

In the chart, radar, fishfinder, or weather application:

1. Select **Menu**.
2. Select **Presentation**.
3. Select **Data Overlay Set-up**.
4. To customize Data Cell 1, select **Data Cell 1 > ON**.
5. To customize Data Cell 2, select **Data Cell 2 > ON**.
6. Choose the **Select Data Cell 1** or **Select Data Cell 2** menu item, as appropriate.
7. Select the category that reflects the type of data you want to display in the cell. For example, Depth data.
8. Select the data item.
The data you selected is displayed on-screen in the appropriate data overlay cell.

Customizing the databar

From the homescreen:

1. Select **Customize**.
2. Select **Databar Set-up**.
3. Select **Edit Databar**.
4. In the databar, select the cell that you want to change.
The Select Data Category menu will be displayed.
5. Select the category that reflects the type of data you want to display in the cell. For example, Depth data.
6. Select the data item.
The data you selected is displayed on-screen in the appropriate cell.
7. Select **Home** or **Back** when completed.

List of data items

Depending on connected devices the categories of data available to display in the data application, data overlay, databar, and expanded databar are shown below.

The following table shows the data items available by category.

Data Category	Description	Data Item	Digital	Dial	Graphical
Boat	Types of data generated by your vessel. For example, tank levels.	Fresh Water	✓	✓	✗
		Grey Water	✓	✓	✗
		Black Water	✓	✓	✗
		Live Well	✓	✓	✗
		Trim Tabs (Only available in the Data application.)	✗	✗	✓
Depth	Depth data.	Depth	✓	✗	✗
Distance	Types of data related to distance travelled by your vessel. For example, trip distance.	Log & Trip	✓	✗	✗
		Log	✓	✗	✗
		Trip	✓	✗	✗
		Ground Log, Trip	✓	✗	✗
		Ground Log	✓	✗	✗
		Ground Trip 1	✓	✗	✗
		Ground Trip 2	✓	✗	✗
		Ground Trip 3	✓	✗	✗
		Ground Trip 4	✓	✗	✗
Engine	Types of data generated by engines. For example, oil pressure.	RPM	✓	✓	✗
		Coolant Temperature	✓	✓	✗
		Coolant Pressure	✓	✓	✗
		Oil Pressure	✓	✓	✗
		Boost Pressure	✓	✓	✗
		Alternator	✓	✓	✗
		Engine Load	✓	✓	✗
		Engine Hours	✓	✗	✗
		Engine Tilt	✓	✗	✗

Data Category	Description	Data Item	Digital	Dial	Graphical
Fuel	Types of data related to the fuel system. For example, fuel levels. Note: The options displayed are dependant on the number of engines set in the data application.	Fuel Level 1 (vol)	✓	✗	✗
		Fuel Level 2 (vol)	✓	✗	✗
		Fuel Level 3 (vol)	✓	✗	✗
		Fuel Level 1 (%)	✓	✓	✗
		Fuel Level 2 (%)	✓	✓	✗
		Fuel Level 3 (%)	✓	✓	✗
		Total Fuel	✓	✓	✗
		Total Fuel Flow	✓	✗	✗
		Total Engine Economy	✓	✗	✗
		Estimated Fuel Remaining	✓	✗	✗
		Estimated Distance to Empty	✓	✗	✗
		Estimated Time to Empty	✓	✗	✗
		Fuel Used (trip)	✓	✗	✗
		Fuel Used (season)	✓	✗	✗
Environment	Environmental-related data. For example, air temperature.	Pressure	✓	✗	✗
		Air Temperature	✓	✗	✗
		Set & Drift	✓	✗	✗
		App Wind Chill	✓	✗	✗
		True Wind Chill	✓	✗	✗
		Humidity	✓	✗	✗
		Dew Point	✓	✗	✗
		Sea Temperature	✓	✗	✗
GPS	GPS-related data. For example, vessel position.	Vessel Position	✓	✗	✗
		COG & SOG	✓	✗	✗
		COG	✓	✗	✗
		SOG	✓	✗	✗
Heading	Heading-related data. For example, locked heading.	Heading	✓	✗	✗
		Locked Heading	✓	✗	✗

Data Category	Description	Data Item	Digital	Dial	Graphical
Navigation	Types of data related to navigation. For example, bearing to waypoint.	Cursor Position (Only available in the Databar and data overlay.)	✓	✗	✗
		Cursor info	✓	✗	✗
		Cross Track Error	✓	✗	✗
		Rolling Road (Only available in the Data application.)	✗	✗	✓
		Compass	✗	✓	✗
		Target Position	✓	✗	✗
		Bearing to Waypoint	✓	✗	✗
		Distance to Waypoint	✓	✗	✗
		WPT TTG	✓	✗	✗
		Waypoint Info	✓	✗	✗
Pilot	Pilot-related data. For example, rudder.	Rudder	✓	✗	✗
Speed	Speed-related data. For example, VMG (Velocity Made Good) to Waypoint.	Speed	✓	✗	✗
		VMG to Waypoint	✓	✗	✗
Time	Time-related data. For example, local time.	Local Time	✓	✗	✗
		Local Date	✓	✗	✗
Wind	Wind-related data. For example, VMG (Velocity Made Good) to Windward.	TWS & TWA	✓	✗	✗
		AWS & AWA	✓	✗	✗
		GWS & GWD	✓	✗	✗
		VMG to Windward	✓	✗	✗
None					

Note: The engine data category shown above will contain one set of data items per engine.

25.7 System set-up menus

The system set-up menus enable you to configure your display and connected external devices.

The following menus are available:

Menu item	Description	Notes
Alarms	Enables you to configure all the different types of alarms produced by the display and connected equipment.	
Pilot Controls	Displays the Pilot Control dialog.	Only available when a Raymarine autopilot is detected on the system and Autopilot Control is set to On.
Fuel Manager	Displays the Fuel manager page	
Audio Controls	Displays the audio controls pop-up. <div style="border: 1px solid black; padding: 2px; margin-top: 5px;">Note: Not available on New c Series displays.</div>	Only available when connected to an audio device via bluetooth.
Ground Trip Resets	Resets the chosen ground trip distance counter to zero.	
System Settings	Enables you to configure the settings for external devices connected to the display.	
Maintenance	Provides diagnostic information. Also enables you to designate the data master and reset the display to factory settings.	

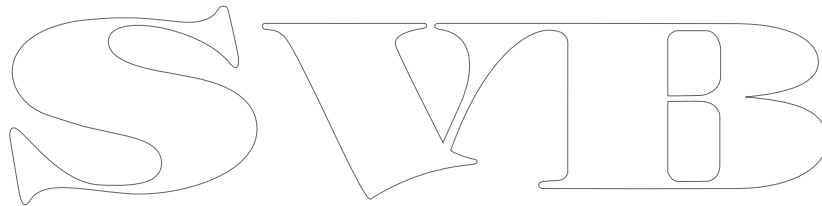

Alarms menu

Menu item	Description	Options
MOB Data Type	Determines whether Position or Dead Reckoning (DR) data is displayed. Assuming that your vessel and the MOB are subject to the same tide and wind effects, the Dead Reckoning setting normally gives a more accurate course.	<ul style="list-style-type: none"> • Dead Reckoning • Position (default)
Alarm Clock	When set to On, an alarm is triggered at the time you specify for the Alarm Clock Time setting.	<p>Alarm Clock</p> <ul style="list-style-type: none"> • Off (default) • On <p>Alarm Clock Time</p> <ul style="list-style-type: none"> • 00:00 (default) • 00.01 to 24:00 hrs
Anchor Drift	When set to On, the Anchor Drift alarm is triggered when your vessel drifts from your anchor position by more than the distance you specify for the Anchor Drift Range setting.	<p>Anchor Drift</p> <ul style="list-style-type: none"> • Off (default) • On <p>Anchor Drift Range</p> <ul style="list-style-type: none"> • 0.01 — 9.99 nm (or equivalent units)
Countdown Timer	When set to On, counts down the time period you specify for the Timer Period setting, and triggers an alarm when zero is reached.	<p>Countdown Timer</p> <ul style="list-style-type: none"> • Off (default) • On <p>Timer Period</p> <ul style="list-style-type: none"> • 00h00m (default) • 00h01m to 99h59m
AIS Targets	When set to On, the alarm for Dangerous Targets is enabled. This option is only available when an AIS unit is detected. Refer to the AIS section for details.	<p>Dangerous Targets</p> <ul style="list-style-type: none"> • On (default) • Off
Engine Alarms	When set to On then warning alarms from connected engine management systems will be displayed on the multifunction display.	<p>Engine Alarms</p> <ul style="list-style-type: none"> • On (default) • Off
Fishfinder Deep	<p>If this option is set to On, an alarm is triggered when the depth exceeds the value that you specify. This option is only available when a sonar module is detected.</p> <div style="border: 1px solid black; padding: 5px; margin-top: 10px;"> <p>Note: The Fishfinder Deep alarm limit cannot be set to a value less than the Shallow Limit.</p> </div>	<p>Fishfinder Deep</p> <ul style="list-style-type: none"> • Off (default) • On <p>Deep Limit</p> <ul style="list-style-type: none"> • 2 ft (or equivalent units) to the maximum of the transducer range
Fishfinder Shallow	<p>If this option is set to On, an alarm is triggered when the depth drops below the value that you specify. This option is only available when a sonar module is detected.</p> <div style="border: 1px solid black; padding: 5px; margin-top: 10px;"> <p>Note: The Fishfinder Shallow alarm limit cannot be set to a value greater than the Deep Limit.</p> </div>	<p>Fishfinder Shallow</p> <ul style="list-style-type: none"> • Off (default) • On <p>Shallow Limit</p> <ul style="list-style-type: none"> • 2 ft (or equivalent units) to the maximum of the transducer range
Fish	<p>If the Fish alarm and fish depth limits alarm are set to On, a warning sounds is triggered if any target meets the sensitivity level and is within the Shallow Fish Limit and Deep Fish Limit that you specify. The following items are available in the sub-menu:</p> <ul style="list-style-type: none"> • Fish — Switches fish alarm On and Off. • Fish Sensitivity — If the Fish alarm is set to On, an alarm is triggered when the fish return strength reaches the sensitivity that you specify. • Fish Depth Limits — Switches depth limits On and Off. • Shallow Fish Limit — Specifies the lower value for the Fish Alarm Depth Limit. 	<p>Fish</p> <ul style="list-style-type: none"> • Off (default) • On <p>Fish Sensitivity</p> <ul style="list-style-type: none"> • 1 to 10 <p>Fish Depth Limits</p> <ul style="list-style-type: none"> • On • Off (default)

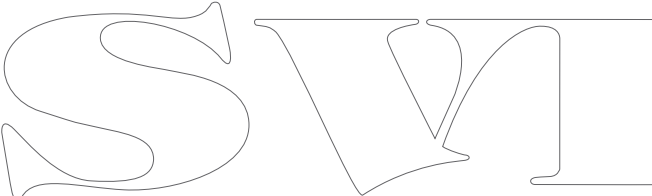
Menu item	Description	Options
	<ul style="list-style-type: none"> • Deep Fish Limit — Specifies the upper value for the Fish Alarm Depth Limit. 	<p>Shallow Fish Limit</p> <ul style="list-style-type: none"> • 2 ft (or equivalent units) to the maximum of the transducer range <p>Deep Fish Limit</p> <ul style="list-style-type: none"> • 2 ft (or equivalent units) to the maximum of the transducer range
Fuel Manager	In the fuel manager alarm options you can switch the low fuel warning alarm on or off and specify the fuel level at which the alarm is triggered.	<p>Low Fuel</p> <ul style="list-style-type: none"> • On • Off (default) <p>Fuel Level</p> <ul style="list-style-type: none"> • 0 to 99999
Guard Zone	The Guard Zone feature in the radar application triggers an alarm when a target is within a specified zone. You can adjust the sensitivity of the alarm. Ensure that the sensitivity is not set too low, or targets may be missed and the alarm will not be triggered.	<p>Guard Zone Sensitivity</p> <ul style="list-style-type: none"> • 1% to 100%
Off Track	When set to On, during active navigation an alarm is triggered when your vessel steers off-track more than the value you specify for the Off Track XTE setting.	<p>Off Track Alarm</p> <ul style="list-style-type: none"> • Off (default) • On <p>Off Track XTE</p> <ul style="list-style-type: none"> • 0.01 to 9.99 nm (or equivalent units)
Sea Temperature	<p>When set to On, triggers an alarm when the sea temperature is equal to or lower than the limit you specify for the Lower Temp Limit or equal to or greater than the limit you specify for the Upper Temp Limit setting.</p> 	<p>Sea Temperature</p> <ul style="list-style-type: none"> • Off (default) • On <p>Lower Temp Limit</p> <ul style="list-style-type: none"> • 60 degrees fahrenheit (or equivalent units) • -09.9 to +99.7 degrees fahrenheit (or equivalent units) <p>Upper Temp Limit</p> <ul style="list-style-type: none"> • 75 degrees fahrenheit (or equivalent units) • -09.7 to 99.9 degrees fahrenheit (or equivalent units)
Waypoint Arrival	When you arrive at a waypoint, an alarm is triggered. This setting allows you to specify the distance from the target waypoint at which the alarm is triggered. The units used for this setting are based on the units you specify for distance in the Units Set-up menu.	0.01 to 9.99 nm (or equivalent units)

Ground trip resets menu

This menu enables you to resets the chosen ground trip distance counter to zero.

Menu item	Description
Ground Trip 1 Reset	Resets the ground trip 1 distance counter to zero.
Ground Trip 2 Reset	Resets the ground trip 2 distance counter to zero.
Ground Trip 3 Reset	Resets the ground trip 3 distance counter to zero.
Ground Trip 4 Reset	Resets the ground trip 4 distance counter to zero.

System settings menu

Menu item	Description	Options
Autopilot Control	Enables and disables autopilot controls from your multifunction display.	<ul style="list-style-type: none"> On Off
DSC Alerts	Enables and disables DSC radio alerts on your multifunction display.	<ul style="list-style-type: none"> On Off
GPS Set-up	Provides GPS setting options.	<ul style="list-style-type: none"> View Satellite Status Differential GPS COG/SOG Filter Restart GPS
Internal GPS	Switches the multifunction displays internal GPS On or Off. Note: The Internal GPS option is not available on the e165 multifunction display.	<ul style="list-style-type: none"> On Off
Data Sources	Enables selection of preferred sources of data for connected equipment. Note: The Data Sources menu is only available on displays set as Data Master.	<ul style="list-style-type: none"> GPS GPS Datum Time and Date Heading Depth Speed Wind
External Devices	Enables set-up of compatible externally connected devices.	Refer to the <i>External devices menu</i> section of the manual.
Wireless Connections	Provides access to the Wi-Fi and bluetooth connection options.	Refer to the <i>Wireless connections menu</i> section of the manual.
NMEA Set-up	Enables you to configure settings for NMEA devices.	Refer to the <i>NMEA set-up menu</i> section of the manual.
System Preferences	Enables you to configure system settings	Refer to the <i>System preferences menu</i> section of the manual.
Simulator	Switches simulator mode On or Off.	<ul style="list-style-type: none"> Off On On (Demo movie)

- Status.
- Azimuth angle.
- Elevation angle.
- A sky-view to show the position of tracked satellites.

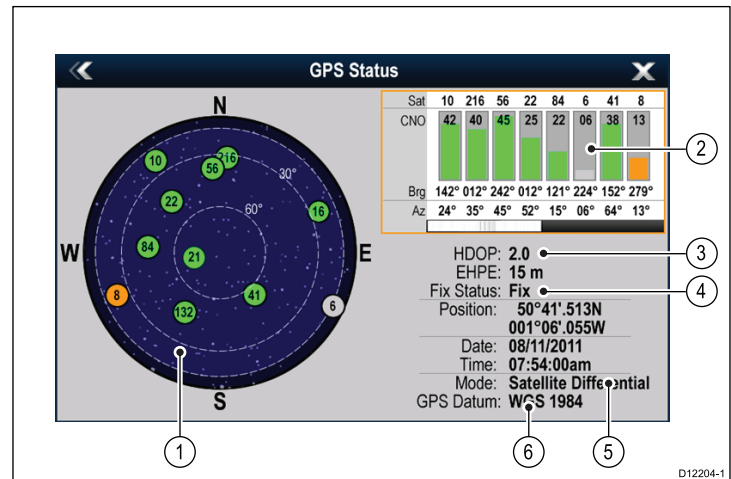

Item	Description
1	Sky view — a visual representation of the position of tracked satellites.
2	Satellite status — displays the signal strength and status of each satellite identified in the sky view diagram on the left of the screen. The colored bars have the following meanings: <ul style="list-style-type: none"> • Grey = searching for satellite. • Green = satellite in use. • Orange = tracking satellite.
3	Horizontal Dilution of Position (HDOP) — a measure of GPS accuracy, calculated from a number of factors including satellite geometry, system errors in the data transmission and system errors in the GPS receiver. A higher figure signifies a greater positional error. A typical GPS receiver has an accuracy of between 5 and 15 m. As an example, assuming a GPS receiver error of 5 m, an HDOP of 2 would represent an error of approximately 15 m. Please remember that even a very low HDOP figure is NO guarantee that your GPS receiver is providing an accurate position. If in doubt, check the displayed vessel position in the chart application against your actual proximity to a known charted object.
4	Fix status — indicates the actual mode the GPS receiver is reporting (No Fix, Fix, D Fix or SD Fix).
5	Mode — the mode currently selected by the GPS receiver.
6	Datum — The GPS receiver's datum setting affects the accuracy of the vessel position information displayed in the chart application. In order for your GPS receiver and multifunction display to correlate accurately with your paper charts, they must be using the same datum.

GPS setup

The GPS setup options enable you to configure a connected GPS receiver.

The Global Positioning System (GPS) is used to position your vessel on the chart. You can set up your GPS receiver and check its status from the GPS Status option in the **System Settings** menu. For each tracked satellite, the screen provides the following information:

- Satellite number.
- Signal strength bar.

The accuracy of the GPS receiver depends on the parameters detailed above, especially the azimuth and elevation angles which are used in triangulation to calculate your position.

Multiple data sources (MDS) overview

Installations that include multiple instances of data sources can cause data conflicts. An example is an installation featuring more than one source of GPS data.

MDS enables you to manage conflicts involving the following types of data:

- GPS Position.
- Heading.
- Depth.
- Speed.
- Wind.

Typically this exercise is completed as part of the initial installation, or when new equipment is added.

This menu enables you to select the external sensors and devices that will provide data to the display.

Auto / manual selection

Each dialog enables you to view and select your preferred data source. selection of data source can be manual or set to automatic:

- **Auto** — the display will automatically select a device and attempt to resolve any data conflicts that may occur where there is more than one source of data for that particular data source (for example, multiple GPS receivers).

If this exercise is NOT completed the system will automatically attempt to resolve data conflicts. However, this may result in the system choosing a source of data that you do not want to use.

If MDS is available the system can list the available data sources and allow you to select your preferred data source. For MDS to be available all products in the system that use the data sources listed above must be MDS-compliant. The system can list any products that are NOT compliant. It may be necessary to upgrade the software for these non-compliant products to make them compliant. Visit the Raymarine website (www.raymarine.com) to obtain the latest software for your products. If MDS-compliant software is not available and you do NOT want the system to automatically attempt to resolve data conflicts, any non-compliant product(s) can be removed or replaced to ensure the entire system is MDS-compliant.

Data sources menu

- **Manual** — once the display has performed a search for connected devices you can manually select the preferred device from the list.

Note: Selecting the **Auto** option may result in the system choosing a source of data that you do not want to use.

Device selection

Menu item	Description
GPS	Enables you to search for any externally-connected GPS devices, and select the one you want to use.
GPS Datum	In order for your GPS receiver and multifunction display to correlate accurately with your paper charts, they must be using the same datum. This option enables you to choose the data source for this datum.
Time and Date	Enables you to select the device you want to use for the time and date information used by the display.
Heading	Enables you to select the device you want to use for heading data.
Depth	Enables you to select the device you want to use for depth data.
Speed	Enables you to select the device you want to use for speed data.
Wind	Enables you to select the device you want to use for wind data.

External devices menu

This menu enables you to configure the external devices connected to the display.

Menu item	Description	Notes
Fishfinder Set-up	Enables you to select an external transducer and configure the options for the unit, such as depth offset. Also enables you to configure the options for an internal or external sonar module.	For an explanation of these options refer to the <i>Transducer set-up menu options</i> described in the Fishfinder section of this document.
Radar Set-up	Enables you to make radar scanner adjustments, such as tune adjust and time transmit.	For an explanation of these options refer to the <i>Scanner set-up menu options</i> described in the Radar section of this document.
AIS Unit Set-up	Enables you to configure additional functions for AIS units, such as Silent Mode. This menu item is only available when an AIS unit is detected or when Simulator mode is On.	For an explanation of these options refer to the <i>AIS menu options</i> described in the AIS section of this document.
Remote Control	Enables you to customize certain controls for Raymarine Bluetooth remote control units (for example, RCU-3).	For an explanation of these options refer to the <i>Remote Control</i> section of this document.
Transducers Set-up	Displays a list of connected transducers which you can select and calibrate.	
Weather Set-up	Enables you to select the bus your weather receiver is connected to: <ul style="list-style-type: none"> • SeaTalk^{hs} • SeaTalk^{ng} 	

Connections menu

This menu enables you to connect wireless Bluetooth and Wi-Fi devices to the display.

Menu item	Description	Options
Bluetooth	Enable or disable Bluetooth on the display.	<ul style="list-style-type: none"> • On • Off (default)
Wi-Fi	Enable or disable Wi-Fi on the display.	<ul style="list-style-type: none"> • On • Off (default)
Connection Manager	<p>Provides a list of Bluetooth devices in range. When you highlight a connection in the list and press OK, the following options are available:</p> <ul style="list-style-type: none"> • Unpair / Forget this device — Disconnect the device and remove it from the connection list. If you unpair a device in this way you must re-pair the device if you want to connection it again to the multifunction display. • Audio Control — If this option is set to On, you can control the audio for a compatible wireless media player, from the multifunction display. 	<ul style="list-style-type: none"> • Unpair / Forget this device • Audio control On / Off.
New Bluetooth Connection	Selecting this menu item initiates the Bluetooth pairing process. This is necessary for connecting a wireless remote control unit or media player device to the multifunction display.	
Wi-Fi Name	Enables you to specify an SSID (WiFi Name) for connecting WiFi devices using an encrypted connection. If you want to prevent unauthorized devices from connecting to your display you must specify the same SSID for both the multifunction display and the wireless device you want to connect to the display.	
Wi-Fi Security	You can encrypt the WiFi connection on the multifunction display to prevent unauthorized devices from accessing the connection. This menu item enables you to select the type of WPA (WiFi Protected Access) encryption you want to use. WPA2 provides stronger security than WPA.	<ul style="list-style-type: none"> • None • WPA Only • WPA 2 Only. (default) • WPA / WPA2.
Wi-Fi Passphrase	Enables you to specify a password for the WiFi connection. If you want to prevent unauthorized devices from connecting to your display you must specify the same password for both the multifunction display and the wireless device you want to connect to the display.	
Wi-Fi Channel	By default the multifunction display automatically selects an available WiFi channel. If you're experiencing difficulties with wireless video streaming it may be necessary to manually specify a WiFi channel for both the multifunction display and the device you want to stream video to.	<ul style="list-style-type: none"> • 1 (default) • 2 • 3 • 4 • 5 • 6 • 7 • 8 • 9 • 10 • 11
Mobile apps	<p>Enables you to select the type of mobile app in use:</p> <ul style="list-style-type: none"> • Viewing only — RayView • Remote Control — RayRemote or RayControl 	<ul style="list-style-type: none"> • Off (default) • Viewing only • Remote Control

NMEA Set-up menu

This menu enables you to configure settings for NMEA devices.

Menu item	Description	Options
Bridge NMEA Heading	If set to ON, NMEA heading data will be bridged onto the SeaTalk data bus, and will be sent to all NMEA-connected devices. If set to OFF, NMEA heading data will NOT be bridged onto the SeaTalk bus. An example of a use for this setting is when using MARPA with an external fast heading sensor, in which case you	<ul style="list-style-type: none"> • On • Off (default)

Menu item	Description	Options
	should set this option to OFF to ensure that all NMEA-connected units receive heading data from the external heading sensor.	
NMEA Output Settings	Allows you to enable or disable the individual NMEA "sentences" that are sent by the multifunction display to any devices connected the NMEA output port.	<ul style="list-style-type: none"> • APB • BWC • BWR • DBT • DPT • GGA • GLL • GSA • GSV • MTW • MWV • RMA • RMB • RMC • RSD • RTE • TTM • VHW • VLW • VTG • WPL • ZDA
NMEA Input Port 1	Enables you to specify the appropriate port speed for the equipment connected to NMEA Input port 1. Use the AIS 38400 option for AIS receivers.	<ul style="list-style-type: none"> • NMEA 4800 • AIS 38400
NMEA Input Port 2	Enables you to specify the appropriate port speed for the equipment connected to NMEA Input port 2. Use the AIS 38400 option for AIS receivers.	<ul style="list-style-type: none"> • NMEA 4800 • AIS 38400

System preferences menu

Menu item	Description	Options
Bearing mode	Determines how all bearing and heading data is displayed in. This does not affect how the chart or radar displays are drawn.	<ul style="list-style-type: none"> • True (default) • Magnetic
Variation Source	This setting compensates for the naturally occurring offset of the earth's magnetic field. When set to Auto, the system automatically compensates, and displays the compensation value in brackets. To enter your own compensation value, use the Manual option, then specify the value using the Manual Variation setting (see below). This value is also transmitted to any other connected Raymarine instruments.	<ul style="list-style-type: none"> • Auto (compensation value displayed) (default) • Manual
Manual Variation	When the Variation Source menu item is set to Manual (see above), you use the Manual Variation setting to specify the compensation value that you want to use.	<ul style="list-style-type: none"> • Range: 0 to 30 degrees, East or West •
System Datum	<p>In order for your GPS receiver and multifunction display to correlate accurately with your paper charts, they must be using the same datum.</p> <p>The default datum for your multifunction display is WGS1984. If this is not the datum used by your paper charts, you can change the datum used by your multifunction display.</p> <p>When you change the datum for your multifunction display, the chart grid will subsequently move according to the new datum, and the latitude / longitude of the cartographic features will also change accordingly. Your multifunction display will attempt to set up any GPS receiver to the new datum, as follows:</p> <ul style="list-style-type: none"> • The internal GPS receiver will automatically correlate each time you change the datum. 	

Menu item	Description	Options
	<ul style="list-style-type: none"> • If you have a Raymarine GPS receiver using SeaTalk or SeaTalkng, it will automatically correlate each time you change the datum on the multifunction display. • If you have a Raymarine GPS receiver using NMEA 0183, or a third-party GPS receiver, you must correlate it separately. <p>It may be possible to use your multifunction display to correlate an NMEA 0183 GPS receiver. From the homescreen go to Set-up > System settings > GPS Set-up > View Satellite Status. If the datum version is displayed, it may be possible to change it. From the homescreen go to Set-up > System settings > Data Sources > GPS Datum.</p> <div style="border: 1px solid black; padding: 5px; margin-top: 10px;"> <p>Note: Raymarine recommends that you check the displayed vessel position in the chart application against your actual proximity to a known charted object. A typical GPS has an accuracy of between 5 and 15 m.</p> </div>	

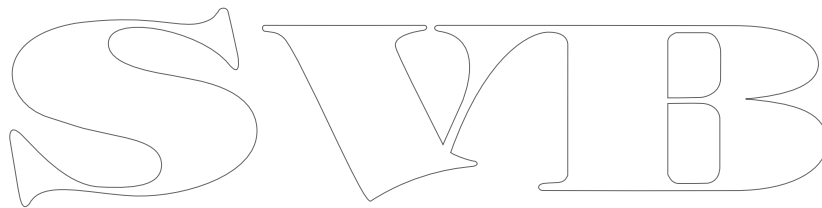

The image shows a large, stylized outline logo for 'SWIB'. The letters are interconnected and have a decorative, calligraphic feel. The 'S' is on the left, followed by 'W', 'I', and 'B' on the right. The entire logo is rendered in a simple black outline on a white background.

Maintenance menu

This menu provides access to systems settings reset and diagnostics.

Menu item	Description	Options
Touchscreen Alignment	<p>If the touchscreen is misaligned to your touch, you can realign it to improve the accuracy. Realignment involves a simple exercise to align an on-screen object with your touch. For best results, perform this exercise when your vessel is anchored or moored.</p> <div style="border: 1px solid black; padding: 5px; margin-top: 10px;"> <p>Note: The Touchscreen alignment option is not required on New c Series displays.</p> </div>	
Data Master	Any system containing more than one networked multifunction display must have a designated data master. The data master is the display which serves as a primary source of data for all displays, it also handles all external sources of information.	
Compatibility	Compatibility mode should be used when connecting the display to a system which includes any of the following Raymarine multifunction displays: E90W, E120W, E140W or a G-Series (GPM400) system. Not all functions will be available refer to the <i>Network constraints</i> sections.	<ul style="list-style-type: none"> • On • Off
System Settings Reset	This option resets your menu options, datapages, and databar settings to factory default. It will NOT affect your waypoints, routes, or tracks data.	<ul style="list-style-type: none"> • Yes • No
System Settings and Data Reset	In addition to the settings reset detailed above, performing a settings and data reset will also remove ALL waypoints, routes, and tracks data.	<ul style="list-style-type: none"> • Yes • No
Diagnostics	<p>Diagnostics provides detailed information on the multifunction display and connected devices. The range of information available includes product serial number, software version, and network status. When you select the Diagnostics menu item the multifunction display scans for any connected equipment and enables you to select the product you want to view. You can also save the diagnostics information to a memory card. This is particularly useful for sending detailed information to Raymarine Customer Support in the event of a technical issue.</p> <p>The Interfaces option allows to view statistics and buffer information for NMEA ports 1 and 2 and SeaTalk^{ng}.</p> <p>The Sirius options allows you to view received messages, memory and errors.</p>	<ul style="list-style-type: none"> • Select Device • Sirius • Save Logs • Erase Logs • Interfaces

Diagnostics menu

If you encounter problems with your multifunction display or peripheral devices you can use the Diagnostics menu to view information about your device and connected equipment.

Select Device	Enables you to a list of all devices connected to the SeaTalk ^{hs} network. You can also select an item in the list to view further details for that device.	<ul style="list-style-type: none"> • Device • Serial No. • Network • Software
Sirius	If connected to a Sirius weather receiver this option enables you to view Sirius weather statistics.	
Save Logs	Allows you to save error logs to SD card for troubleshooting purposes.	
Erase Logs	Selecting this option will erase any crash logs on the device.	
Interfaces	Enables viewing of statistics and viewing and recording of buffers on NMEA inputs and the SeaTalk ^{ng} bus. On New c Series and New e Series displays you can also choose which SD card slot the buffer will be recorded too.	<ul style="list-style-type: none"> • NMEA 1 • NMEA 2 • SeaTalk^{ng} • Record File

Chapter 26: Maintaining your display

Chapter contents

- [26.1 Service and maintenance on page 272](#)
- [26.2 Cleaning on page 272](#)

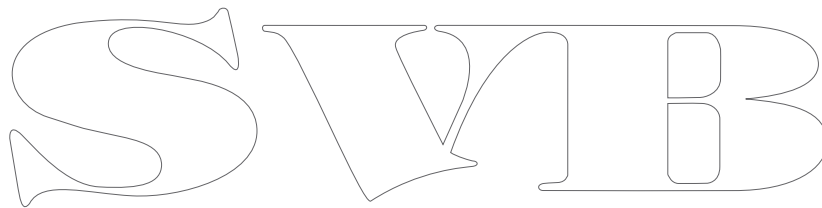

26.1 Service and maintenance

This product contains no user serviceable components. Please refer all maintenance and repair to authorized Raymarine dealers. Unauthorized repair may affect your warranty.

Routine equipment checks

Raymarine strongly recommends that you complete a number of routine checks to ensure the correct and reliable operation of your equipment.

Complete the following checks on a regular basis:

- Examine all cables for signs of damage or wear and tear.
- Check that all cables are securely connected.

26.2 Cleaning

Best cleaning practices.

When cleaning this product:

- Do NOT wipe the display screen with a dry cloth, as this could scratch the screen coating.
- Do NOT use abrasive, or acid or ammonia based products.
- Do NOT use a jet wash.

Cleaning the display case

The display unit is a sealed unit and does not require regular cleaning. If it is necessary to clean the unit, follow this basic procedure:

1. Switch off the power to the display.
2. Wipe the display with a clean, soft cloth (a microfibre cloth is ideal).
3. If necessary, use isopropyl alcohol (IPA) or a mild detergent to remove grease marks.

Note: Do NOT use IPA or any other solvent or detergent on the screen itself.

Note: In certain conditions, condensation may appear inside the display screen. This will not harm the unit, and can be cleared by powering on the display for a short time.

Cleaning the display screen

A coating is applied to the display screen. This makes it water repellent, and prevents glare. To avoid damaging this coating, follow this procedure:

1. Switch off the power to the display.
2. Rinse the screen with fresh water to remove all dirt particles and salt deposits.
3. Allow the screen to dry naturally.
4. If any smears remain, very gently wipe the screen with a clean microfibre cleaning cloth (available from an opticians).

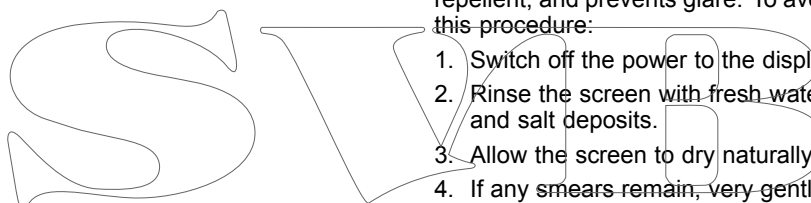

Chapter 27: Troubleshooting

Chapter contents

- [27.1 Troubleshooting on page 274](#)
- [27.2 Power up troubleshooting on page 275](#)
- [27.3 Radar troubleshooting on page 276](#)
- [27.4 GPS troubleshooting on page 277](#)
- [27.5 Sonar troubleshooting on page 278](#)
- [27.6 Thermal camera troubleshooting on page 279](#)
- [27.7 System data troubleshooting on page 280](#)
- [27.8 Video troubleshooting on page 281](#)
- [27.9 Wi-Fi troubleshooting on page 282](#)
- [27.10 Bluetooth troubleshooting on page 283](#)
- [27.11 Touchscreen troubleshooting on page 284](#)
- [27.12 Miscellaneous troubleshooting on page 285](#)

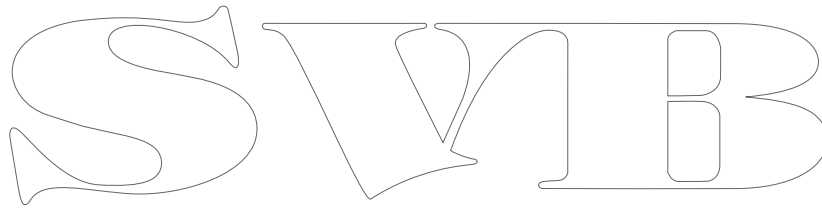

27.1 Troubleshooting

The troubleshooting information provides possible causes and corrective action required for common problems associated with marine electronics installations.

All Raymarine products are, prior to packing and shipping, subjected to comprehensive test and quality assurance programs. However, if you experience problems with the operation of your product this section will help you to diagnose and correct problems in order to restore normal operation.

If after referring to this section you are still having problems with your unit, please contact Raymarine Technical Support for further advice.

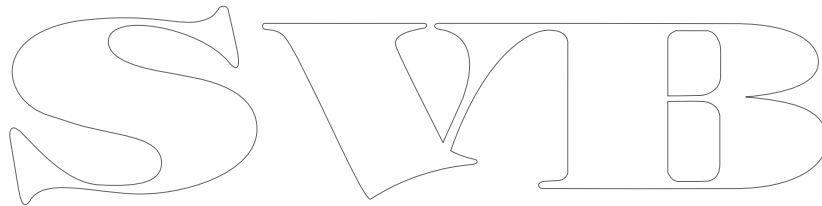
The image shows the letters 'SWIB' in a large, stylized, outlined font. The letters are white with a black outline, set against a plain white background. The 'S' is a simple, rounded shape. The 'W' is formed by two 'V' shapes joined at the top. The 'I' is a simple vertical bar. The 'B' is a simple, rounded shape with a vertical bar in the middle.

27.2 Power up troubleshooting

Problems at power up and their possible causes and solutions are described here.

Problem	Possible causes	Possible solutions
The system (or part of it) does not start up.	Power supply problem.	Check relevant fuses and breakers.
		Check that the power supply cable is sound and that all connections are tight and free from corrosion.
		Check that the power source is of the correct voltage and sufficient current.

SVIB

27.3 Radar troubleshooting

Problems with the radar and their possible causes and solutions are described here.

Problem	Possible causes	Possible solutions
No Data or No scanner message	Radar scanner power supply	Check that the scanner power supply cable is sound and that all connections are tight and free from corrosion.
		Check relevant fuses and breakers.
		Check power source is of the correct voltage and sufficient current (using voltage booster if appropriate).
	SeaTalk ^{hs} / RayNet network problem	Check that the Scanner is correctly connected to a Raymarine network switch or SeaTalk ^{hs} crossover coupler (as applicable).
		Check the status of the Raymarine network switch.
		Check that SeaTalk ^{hs} / RayNet cables are free from damage.
Software mismatch between equipment may prevent communication.	Contact Raymarine technical support.	
Switch at scanner pedestal in OFF position	Ensure scanner pedestal switch is in ON position.	
Radar will not initialize (Voltage control module (VCM) stuck in "sleep mode")	Intermittent or poor power connection	Check power connection at VCM. (Voltage at input = 12 / 24 V, Voltage at output = 40 V)
The bearing of a target on the radar screen is incorrect.	The radar bearing alignment requires correcting.	Check and adjust radar bearing alignment.

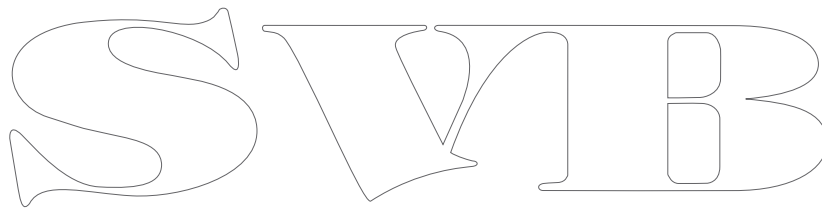

The logo consists of the letters 'S', 'W', 'I', and 'B' in a large, stylized, outlined font. The 'S' is on the left, followed by 'W', 'I', and 'B' to the right. The letters are interconnected and have a decorative, slightly irregular appearance.

27.4 GPS troubleshooting

Problems with the GPS and their possible causes and solutions are described here.

Problem	Possible causes	Possible solutions
"No Fix" GPS status icon is displayed.	Geographic location or prevailing conditions preventing satellite fix.	Check periodically to see if a fix is obtained in better conditions or another geographic location.
	GPS connection fault.	Ensure that external GPS connections and cabling are correct and fault free.
	External GPS antenna in poor position. For example: <ul style="list-style-type: none">• Below decks.• Close proximity to transmitting equipment such as VHF radio.	Ensure GPS antenna has a clear view of the sky.
	GPS installation problem.	Refer to the installation instructions.

Note: A GPS Status screen is available within the Setup menu of Raymarine multifunction displays. This provides satellite signal strength and other relevant information.

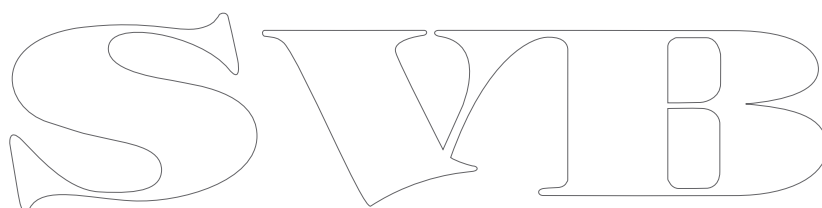
The image shows a large, stylized outline logo for 'SWIB'. The letters are bold and have a decorative, slightly calligraphic feel. The 'S' is on the left, followed by 'W', 'I', and 'B' on the right. The outlines are thin and black.

27.5 Sonar troubleshooting

Problems with the sonar and their possible causes and solutions are described here.

Problem	Possible causes	Possible solutions
Sonar data not available on multifunction display.	Unit power supply fault.	Check the unit power supply and cables.
	Other unit fault.	Refer to the instructions supplied with the unit.
	SeaTalk ^{hs} / RayNet network problem.	Check that the unit is correctly connected to a Raymarine network SeaTalk ^{hs} switch or crossover coupler (as applicable).
		Check the status of the Raymarine network switch (if applicable).
		Check that SeaTalk ^{hs} / RayNet cables are free from damage.
Software mismatch between equipment may prevent communication.	Contact Raymarine technical support.	
Problematic depth readings or sonar image.	Gain or Frequency settings may be inappropriate for present conditions.	Check the sonar presets, gain and frequency settings.
	Unit power supply fault	Check the voltage from the power supply, if this is too low it can affect the transmitting power of the unit.
	Unit cable fault.	Ensure that the power, transducer and all other cables to the unit are properly connected and free from damage.
	Transducer fault	Check that the transducer is mounted correctly and is clean.
		If you have a transom-mount transducer, check that the transducer hasn't kicked up due to hitting an object.
	Other unit fault.	Refer to the instructions supplied with the unit.
	Vessel stationary	Fish arches are not displayed if the vessel is stationary, fish will appear on the display as straight lines.
	High vessel speed	Turbulence around the transducer may be confusing the unit.
Scroll speed set to zero	Adjust scroll speed	
Incorrect speed reading	Paddle wheel fault	Check that the paddle wheel is clean.
	No speed offset set	Add speed offset.
	Incorrect calibration	Re-calibrate equipment

27.6 Thermal camera troubleshooting

Problems with the thermal camera and their possible causes and solutions are described here.

Problem	Possible causes	Possible solutions
Video not displayed.	Camera is in Standby mode.	The camera will not display video if it is in Standby mode. Use the camera controls (either the thermal camera application or JCU) to "wake" the camera from standby.
	Problem with the thermal camera video connections.	<ul style="list-style-type: none"> • Check thermal camera video cables are sound and properly connected. • Ensure that the video is connected into video input 1 at the multifunction display or GVM. • Ensure that the correct video input is selected at the display.
	Problem with power supply to the camera or JCU (if used as the primary controller)	<ul style="list-style-type: none"> • Check the power connections to the camera and JCU / PoE injector (if used). • Ensure that the power switch / breaker is on. • Check the fuse / breaker state.
Cannot control thermal camera from Raymarine display or keyboard.	Thermal camera application is not running.	Ensure the thermal camera application is running on the multifunction display (as oppose to the video application which does not have camera controls).
Erratic or unresponsive controls.	Network problem.	Check that the controller and thermal camera are correctly connected to the network. (Note: This may be a direct connection or via a Raymarine network switch.)
		Check the status of the Raymarine network switch.
		Check that SeaTalk ^{hs} / RayNet cables are free from damage.
	Control conflict, e.g. caused by multiple users at different stations.	Ensure that no other controllers are in use at the same time.
Problem with the controller.	<p>Check power / network cabling to the controller and PoE injector (PoE only used with optional Joystick Control Unit).</p> <p>Check other controllers if available. If other controllers are operating this will eliminate the possibility of a more fundamental camera fault.</p>	
Cannot switch between thermal and visible (VIS / IR) video image .	Camera is not a dual payload model.	Only "dual payload" (dual lens) thermal cameras support VIS / IR switching.
	VIS / IR cable not connected.	Ensure that the VIS / IR cable is connected from the camera to the Raymarine system. (The IR-only cable does not support switching).
Noisy image.	Poor quality or faulty video cable.	Ensure that the video cable is no longer than necessary. The longer the cable is (or the smaller the wire gauge / thickness), the more severe the losses become. Use only high quality shielded cable suitable for a marine environment.
	Cable is picking up electromagnetic interference (EMI) from another device.	<ul style="list-style-type: none"> • Ensure you are using a high quality shielded cable. • Ensure proper cable separation, for example do not run data and power cables in close proximity with each other.
Image too dark or too light.	Display brightness is set too low.	Use the brightness controls at the display to adjust accordingly.
	The contrast or brightness settings in the thermal camera application are set too low.	Use the appropriate menu in the thermal camera application to adjust the contrast and brightness of the image.
	The Scene Mode is not appropriate for the current conditions.	A particular environment may benefit from a different Scene Mode setting. For example, a very cold background (such as the sky) could cause the camera to use a wider temperature range than appropriate. Use the SCENE button.
Image freezes momentarily.	FFC (Flat Field Correction).	The image will pause momentarily on a periodic basis during the Flat Field Correction (FFC) cycle. Just prior to the FFC, a small green square will appear in the upper left corner of the screen.
Image is inverted (upside down).	Camera "Ball down" setting is incorrect.	Ensure that the Ball down setting within the thermal camera system setup menu is set correctly.

27.7 System data troubleshooting

Aspects of the installation can cause problems with the data shared between connected equipment. Such problems, their possible causes and solutions are described here.

Problem	Possible causes	Possible solutions
Instrument, engine or other system data is unavailable at all displays.	Data is not being received at the display.	Check the data bus (e.g. SeaTalk ^{ng}) wiring and connections.
		Check the overall integrity of the data bus (e.g. SeaTalk ^{ng}) wiring.
		If available refer to the reference guide for the data bus. (e.g. SeaTalk ^{ng} reference manual)
	Data source (e.g ST70 instrument or engine interface) is not operating.	Check the source of the missing data (e.g. ST70 instrument or engine interface).
		Check the power to the SeaTalk bus.
		Refer to the manufacturer's handbook for the equipment in question.
Software mismatch between equipment may prevent communication.	Contact Raymarine technical support.	
Instrument or other system data is missing from some but not all displays.	Network problem	Check that all required equipment is connected to the network..
		Check the status of the Raymarine network Switch.
		Check that SeaTalk ^{hs} / RayNet cables are free from damage.
	Software mismatch between equipment may prevent communication.	Contact Raymarine technical support

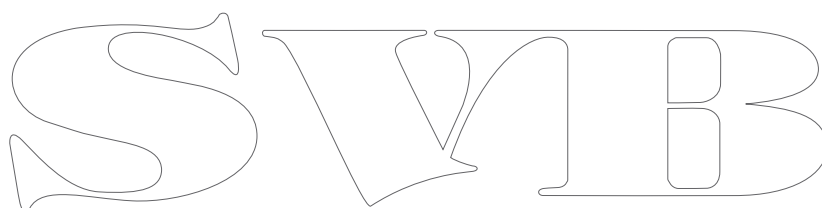

The image shows a large, stylized outline logo for 'SWIB'. The letters are interconnected and have a decorative, calligraphic feel. The 'S' is on the left, followed by 'W', 'I', and 'B' on the right. The logo is centered on the page.

27.8 Video troubleshooting

Problems with the video inputs and their possible causes and solutions are described here.

Problem	Possible causes	Possible solutions
No signal message on screen (video image not displayed)	Cable or connection fault	Check that the connections are sound and free from corrosion.

SVIB

27.9 Wi-Fi troubleshooting

Aspects of the installation can cause problems with the data shared between wireless devices. Such problems, their possible causes and solutions are described here.

Problem	Possible causes	Possible solutions
No wireless connection.	Tablet / smartphone does not have a wireless connection established with the multifunction display.	Ensure that Wi-Fi is enabled on the multifunction display (Homescreen: > Set-Up > System Settings > Wireless Connections > Wi-Fi > On).
		Ensure that the "Wi-Fi" option is enabled on the iPhone (available from the phone's Settings menu).
		Ensure that the Raymarine connection is selected as the W-iFi network. If a passcode has been specified for the multifunction display's Wi-Fi connection ensure that the same passcode is entered into the iPhone when prompted.
No Raymarine app on device	Tablet / smartphone does not have Raymarine app installed and running.	Download the required Raymarine app from the relevant application store. Start the Raymarine app on your device.
	Mobile applications are NOT enabled on the multifunction display.	Enable "Viewing only" or "Remote Control" (Homescreen: > Set-Up > System Settings > Wireless Connections > Mobile Apps).
Raymarine app runs slowly or not at all.	Device not compatible with Raymarine app	Recommended device requirements: <ul style="list-style-type: none"> • iOS Devices = Best performance achieved on iPhone 4 or later and iPad 2 or later. • Android/Kindle Fire = Best performance achieved with 1GHz processor and better and running 2.2.2. or later.
	MFD software incompatible with mobile application	Ensure your MFD contains software application version 3.15 or later.
No waypoint / routes synchronization with Navionic Marine app.	Smartphone / tablet does not have "Navionics Marine" app installed and running.	Download the "Navionics Marine" app from the relevant app store.
		Start the "Navionics Marine" app on the device.
	Chart application is not running on the multifunction display.	Start the chart application on the multifunction display.
Weak or intermittent Wi-Fi signal.	Interference from other wireless devices in the vicinity.	Multiple wireless devices running simultaneously (such as laptops, phones, and other wireless devices) can sometimes cause wireless signal conflicts. Temporarily disable each wireless device in turn until you have identified the device causing the interference.
Smartphone / tablet can no longer connect to the internet or receive e-mails after using a Raymarine mobile app.	Device still connected to the multifunction display.	Ensure the access point on your device is switched back to your previous access point (e.g. the marina Wi-Fi).

27.10 Bluetooth troubleshooting

Aspects of the installation can cause problems with the data shared between wireless devices. Such problems, their possible causes and solutions are described here.

Problem	Possible causes	Possible solutions
No wireless connection.	iPhone does not have a Bluetooth connection established with the multifunction display.	Ensure that Bluetooth is enabled on the multifunction display (Homescreen: > Set-Up > System Settings > Connections > Bluetooth > On).
		Ensure that the "Bluetooth" option is enabled on the iPhone (available from the phone's Settings / General menu).
		Ensure that the Bluetooth device is paired with the multifunction display that you want to use it with. To do this: Homescreen: > Set-Up > System Settings > Connections > New Bluetooth Connection .
No media player control.	Media player device is not compatible with the Bluetooth AVRCP protocol (version 2.1 or higher).	Check the Bluetooth AVRCP compatibility with the device manufacturer. If the device is not Bluetooth AVRCP compatible then it is not suitable for wireless use with the multifunction display.
	"Audio Control" is NOT enabled on the multifunction display.	Enable "Audio Control" (Homescreen: > Set-Up > System Settings > Connections > Connections Manager > Audio Control > On).
Weak or intermittent Bluetooth signal.	Interference from other wireless devices in the vicinity.	Multiple wireless devices running simultaneously (such as laptops, phones, and other wireless devices) can sometimes cause wireless signal conflicts. Temporarily disable each wireless device in turn until you have identified the device causing the interference.

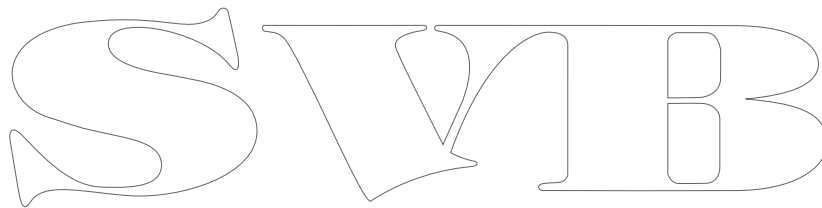

27.11 Touchscreen troubleshooting

Problems with the touchscreen and their possible causes and solutions are described here.

Problem	Possible causes	Possible solutions
Touchscreen does not operate as expected	Touch lock is enabled	Use the Trackpad to turn off the touch lock on the home screen.
	Screen is not being operated with bare fingers, for example gloves are being worn	Bare fingers must make contact with the screen for correct operation. Alternatively you may use conductive gloves.
	Touchscreen requires calibration	Use the setup menus to calibrate the touchscreen.
	Saltwater deposits on the screen	Carefully clean and dry the screen in accordance with the instructions provided.

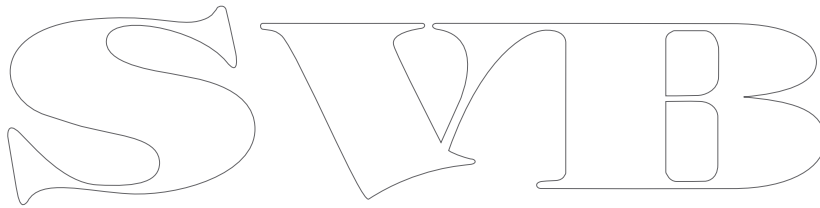
The image shows a large, stylized outline logo for 'SWIB'. The letters are bold and have a decorative, slightly calligraphic feel. The 'S' is on the left, followed by 'W', 'I', and 'B' on the right. The logo is centered horizontally on the page.

27.12 Miscellaneous troubleshooting

Miscellaneous problems and their possible causes and solutions are described here.

Problem	Possible causes	Possible solutions
Display behaves erratically: <ul style="list-style-type: none"> • Frequent unexpected resets. • System crashes or other erratic behavior. 	Intermittent problem with power to the display.	Check relevant fuses and breakers.
		Check that the power supply cable is sound and that all connections are tight and free from corrosion.
		Check that the power source is of the correct voltage and sufficient current.
	Software mismatch on system (upgrade required).	Go to www.raymarine.com and click on support for the latest software downloads.
	Corrupt data / other unknown issue.	Perform a factory reset. <div style="border: 1px solid black; padding: 5px; margin-top: 5px;"> <p>Important: This will result in the loss of any settings and data (such as waypoints) stored on the product. Save any important data to a memory card before resetting.</p> </div>

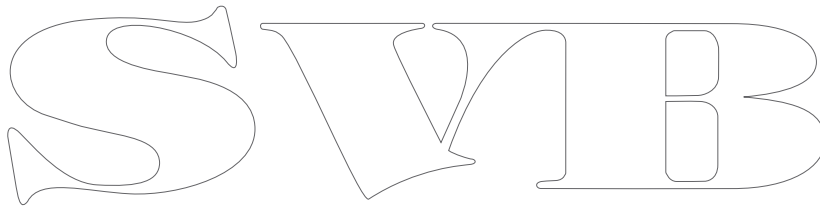

The image shows a large, stylized outline logo consisting of the letters 'S', 'V', 'M', and 'B' in a decorative, serif font. The letters are interconnected and have a classic, elegant appearance.

SWIB

Chapter 28: Technical support

Chapter contents

- [28.1 Raymarine customer support on page 288](#)
- [28.2 Third-party support on page 288](#)

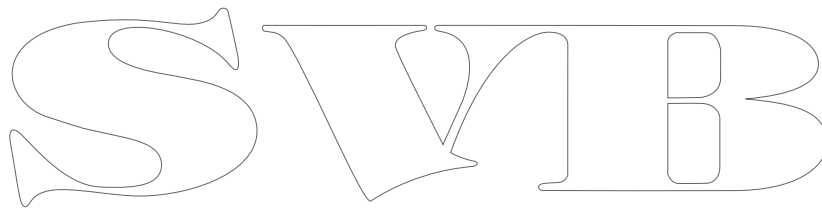

28.1 Raymarine customer support

Raymarine provides a comprehensive customer support service. You can contact customer support through the Raymarine website, telephone and email. If you are unable to resolve a problem, please use any of these facilities to obtain additional help.

Web support

Please visit the customer support area of our website at:

www.raymarine.com

This contains Frequently Asked Questions, servicing information, e-mail access to the Raymarine Technical Support Department and details of worldwide Raymarine agents.

Telephone and email support

In the USA:

- **Tel:** +1 603 324 7900
- **Toll Free:** +1 800 539 5539
- **Email:** support@raymarine.com

In the UK, Europe, the Middle East, or Far East:

- **Tel:** +44 (0)13 2924 6777
- **Email:** ukproduct.support@raymarine.com

Product information

If you need to request service, please have the following information to hand:

- Product name.
- Product identity.
- Serial number.
- Software application version.

You can obtain this product information using the menus within your product.

Viewing product information

With the homescreen displayed:

1. Select **Set-up**.
2. Select **Maintenance**.
3. Select **Diagnostics**.
4. Select **Select Device**.
5. Select the relevant product from the list.
6. Select **Show All Data**.

28.2 Third-party support

Contact and support details for third-party suppliers can be found on the appropriate websites.

Navionics

www.navionics.com

Sirius

www.sirius.com

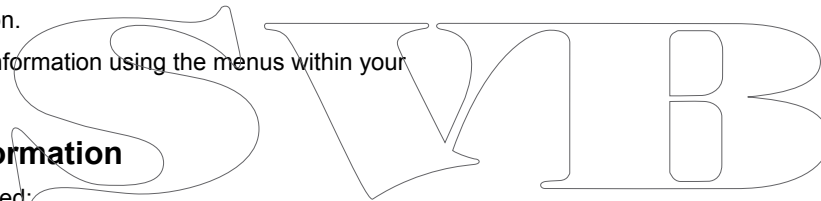

Chapter 29: Technical specification

Chapter contents

- [29.1 Technical specification on page 290](#)

SWIB

29.1 Technical specification

New a Series physical specifications

Dimensions	<ul style="list-style-type: none"> • Width: 163.57 mm (6.44 in.) • Height (NOT including bracket): 143.47 mm (5.65 in.) • Height (including bracket): 162.72 mm (6.41 in.) • Depth (NOT including cables): 74.1 mm • Depth (including cables): 167.5 mm (6.6 in.)
Weight (bare unit)	0.715 kg (1.58 lbs)

e7 / e7D Physical specifications

Dimensions	<ul style="list-style-type: none"> • Width: 233 mm (9.17 in.) • Height (NOT including bracket): 145 mm (5.71 in.) • Height (including bracket): 180 mm (7.09 in.) • Depth (NOT including cables): 64 mm (2.52 in.) • Depth (including cables): 160 mm (6.29 in.)
Weight (bare unit)	e7 <ul style="list-style-type: none"> • 1.465 kg (3.23 lb.) e7D <ul style="list-style-type: none"> • 1.550 kg (3.42 lb.)
Weight (boxed unit)	e7 <ul style="list-style-type: none"> • 2.385 kg (5.26 lb.) e7D <ul style="list-style-type: none"> • 2.423 kg (5.34 lb.)

e95 / e97 / c95 / c97 Physical specifications

Dimensions	<ul style="list-style-type: none"> • Width: 290 mm (11.42 in.) • Height (NOT including bracket): 173 mm (6.81 in.) • Height (including bracket): 212 mm (8.35 in.) • Depth (NOT including cables): 64 mm (2.52 in.) • Depth (including cables): 160 mm (6.29 in.)
Weight (bare unit)	e95 / c95 <ul style="list-style-type: none"> • 2.165 kg (4.77 lb.) e97 / c97 <ul style="list-style-type: none"> • 2.265 kg (4.99 lb.)
Weight (boxed unit)	e95 / c95 <ul style="list-style-type: none"> • 3.540 kg (7.8 lb.) e97 / c97 <ul style="list-style-type: none"> • 3.635 kg (8 lb.)

e125 / e127 / c125 / c127 Physical specifications

Dimensions	<ul style="list-style-type: none"> • Width: 354 mm (13.94 in.) • Height (NOT including bracket): 222 mm (8.74 in.) • Height (including bracket): 256 mm (10.08 in.) • Depth (NOT including cables): 69 mm (2.72 in.) • Depth (including cables): 160 mm (6.29 in.)
Weight (bare unit)	e125 / c125 <ul style="list-style-type: none"> • 3.320 kg (7.32 lb.) e127 / c127 <ul style="list-style-type: none"> • 3.450 kg (7.6 lb.)
Weight (boxed unit)	e125 / c125 <ul style="list-style-type: none"> • 4.955 kg (10.9 lb.) e127 / c127 <ul style="list-style-type: none"> • 5.070 kg (11.18 lb.)

e165 Physical specifications

Dimensions	<ul style="list-style-type: none"> • Width: 426 mm (16.8 in.) • Height (NOT including bracket): 281.4 mm (11.1 in.) • Height (including bracket): 295 mm (11.6 in.) • Depth (NOT including cables): 68.4 mm (2.7 in.) • Depth (including cables): 176.6 mm (7 in.)
Weight (bare unit)	5.6 kg (12.3lb)

New a Series power specification

Nominal supply voltage	12 V dc
Operating voltage range	10.8 V dc to 15.6 V dc
Fuse / Breakers	The unit includes an internal fuse. It is recommended that you fit an additional thermal breaker or fuse at the distribution panel. The suitable fuse rating for the thermal breaker is dependent on the number of devices you are connecting. If in doubt consult an authorized Raymarine dealer
Power consumption	• 33.6 W Max (at full brightness)
LEN (Refer to Seataalk^{®9} reference manual for further information).	1

e7 / e7D Power specification

Nominal supply voltage	13.8 V dc
Operating voltage range	10.2 to 15.6 V dc
Fuse / Breakers	In-line fuse (fitted within power cable) <ul style="list-style-type: none"> • 7 A. (Standard 20 mm glass fuse)
Power consumption (at full brightness)	13.2 W
LEN (Refer to Seataalk^{®9} reference manual for further information).	1

e95 / e97 / e125 / e127 / c95 / c97 / c125 / c127 power specification

Nominal supply voltage	12/24 V dc
Operating voltage range	10.8V dc to 31.2V dc
Fuse / Breakers	In-line fuse (fitted within power cable) <ul style="list-style-type: none"> • 7 A. (Standard 20 mm glass fuse)
Power consumption (at full brightness)	<ul style="list-style-type: none"> • e95 / e97 / c95 / c97 = 16W Max. • e125 / e127 / c125 / c127 = 36W Max.
LEN (Refer to Seatalk ^{ng} reference manual for further information).	1

e165 power specification

Nominal supply voltage	12/24 V dc
Operating voltage range	10.8V dc to 31.2V dc
Fuse / Breakers	In-line fuse (fitted within power cable) <ul style="list-style-type: none"> • 7 A. (Standard 20 mm glass fuse)
Power consumption	<ul style="list-style-type: none"> • 45 W Max (at full brightness)
LEN (Refer to Seatalk ^{ng} reference manual for further information).	1

Environmental specification

Environmental specifications below apply to all display variants

Operating temperature	-25 °C to +55 °C (-13 °F to 131 °F)
Storage temperature	-30 °C to +70 °C (-22 °F to 158 °F)
Relative humidity	Maximum 75%
Waterproof rating	<ul style="list-style-type: none"> • IPX6 and IPX7 • IPX6 (e165 only)

New a Series display specification

Size	5.7 in
Type	TFT backlit LED
Color depth	24-bit
Resolution	640 x 480 VGA
Aspect	4:3
Viewing angle	<ul style="list-style-type: none"> • Left / Right: 60 degrees • Top / Bottom: 60 / 50 degrees
Maximum allowable wrongly illuminated pixels	5

e7 / e7D Display specification

Size	7 in.
Type	TFT backlit LED
Color depth	24-bit
Resolution	800 x 480 pixels (WVGA)
Viewing angle	<ul style="list-style-type: none"> • Left / Right: 70 degrees • Top / Bottom: 70 / 50 degrees

e95 / e97 / c95 / c97 Display specification

Size	9 in.
Type	TFT backlit LED
Color depth	24-bit
Resolution	800 x 480 pixels (WVGA)
Viewing angle	<ul style="list-style-type: none"> • Left / Right: 80 degrees • Top / Bottom: 80 / 60 degrees

e125 / e127 / c125 / c127 Display specification

Size	12 in.
Type	TFT backlit LED
Color depth	24-bit
Resolution	1280 x 800 pixels (WXGA)
Viewing angle	<ul style="list-style-type: none"> • Left / Right: 80 degrees • Top / Bottom: 80 / 60 degrees

e165 Display specification

Size	15.4 in.
Type	TFT backlit LED
Color depth	24-bit
Resolution	1280 x 800 pixels (WXGA)
Aspect ratio	16:9
Viewing angle	<ul style="list-style-type: none"> • Left / Right: 80 degrees • Top / Bottom: 70 degrees
Maximum allowable wrongly illuminated pixels	8

Data connections

Wired connections

NMEA 0183	2x NMEA 0183 ports: <ul style="list-style-type: none"> • NMEA port 1: Input and output, 4800 / 38400 baud • NMEA port 2: Input only, 4800 / 38400 baud <div style="border: 1px solid black; padding: 5px; margin-top: 5px;"> Note: NMEA 0183 connection does not apply to New a Series multifunction displays. </div>
Network (SeaTalk ^{hs})	<ul style="list-style-type: none"> • a65 / a67 / e7 / e7D = 1 x SeaTalk^{hs} port. 100 Mbits/s. RayNet type connection. • e95 / e97 / c95 / c97 / e125 / e127 / c125 / c127 / e165 = 2 x SeaTalk^{hs} port. 100 Mbits/s. RayNet type connection.
SeaTalk ^{ng}	1 x SeaTalk ^{ng} connection

Wireless connections

Wi-Fi	802.11 b / g <div style="border: 1px solid black; padding: 5px; margin-top: 5px;"> Note: Wi-Fi connection does not apply to New a Series multifunction displays. </div>
Bluetooth	AVRCP 2.1+ EDR power class 1.5

Internal GPS specification

The Internal GPS specification applies to the following multifunction displays New a Series, New c Series and New e Series (excluding the e165).

Channels	50
Cold start	<2 minutes
Receiver IC Sensitivity	163 dBm Tracking
Satellite Based Aiding System (SBAS)	WAAS + EGNOS + MSAS
Special features	Active Jamming Reduction
Operating frequency	1575.42MHz
Signal Acquisition	Automatic
Almanac Update	Automatic
Geodetic Datum	WGS-84, alternatives available through Raymarine displays.
Update Rate	1 second
Antenna	Ceramic chip
Accuracy	<ul style="list-style-type: none"> Without SBAS: <= 15 metres 95% of the time With SBAS: <= 5 metres 95% of the time

Conformance specification

Conformance certification applies to all display variants

Conformance	<ul style="list-style-type: none"> NMEA 2000 certification WiFi Alliance certification Bluetooth certification Europe: 1999/5/EC Australia and New Zealand: C-Tick, Compliance Level 2 FCC 47CFR part 15 Industry Canada RSS210
--------------------	--

Internal sonar specification

The internal sonar specifications only apply to the following display variants: a67, c97, c127, e7D, e97 and e127.

Operating frequencies	50 / 83 / 200 KHz
Transmit power	Up to 600 W RMS, depending on transducer
Depth range	Up to 3000 ft, depending on transducer

Video specification

Signal type	Composite
Format	PAL or NTSC
Connector type	BNC (female)
Output resolution	720p

Electronic chart specification

Embedded electronic charts	Navionics worldwide base map.
Compatible chart cards	<ul style="list-style-type: none"> Navionics Ready to Navigate Navionics Silver Navionics Gold Navionics Gold+ Navionics Platinum Navionics Platinum+ Navionics Fish'N Chip Navionics Hotmaps <p>Refer to the Raymarine website (www.raymarine.com) for the latest list of supported chart cards.</p>

Chapter 30: Spares and accessories

Chapter contents

- 30.1 Transducer accessories on page 294
- 30.2 RayNet connector network cables on page 294
- 30.3 SeaTalk^{hs} network cables on page 295
- 30.4 SeaTalk^{hs} patch cables on page 295
- 30.5 Video cables on page 296
- 30.6 Power cables on page 296
- 30.7 a65 / a67 spares on page 297
- 30.8 e7 e7D spares on page 297
- 30.9 e95 / e97 / c95 / c97 spares on page 298
- 30.10 e125 / e127 / c125 / c127 spares on page 298
- 30.11 e165 Spares on page 299

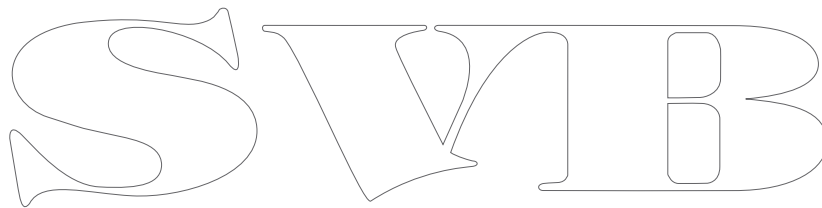

30.1 Transducer accessories

Item	Part number	Notes
P48 sonar transducer	A102140	Transom mount.
P58 sonar transducer	A102138	Transom mount.
1 m (3.28 ft) Minn Kota transducer adaptor cable	A62363	Only for direct connection to sonar variant multifunction display.
0.5 m (1.64 ft) transducer adaptor cable	E66066	For connecting any 600 watt sonar module-compatible sonar transducer directly to a sonar variant multifunction display.

30.2 RayNet connector network cables

Cable	Part number
1 m (3.28 ft) RayNet to SeaTalk ^{hs} (RJ45) cable	A62360
3 m (9.84 ft) RayNet to SeaTalk ^{hs} (RJ45) cable	A80151
10 m (32.8 ft) RayNet to SeaTalk ^{hs} (RJ45) cable	A80159
400 mm (1.3 ft) RayNet to RayNet cable	A80160
2 m (6.56 ft) RayNet to RayNet cable	A62361
5 m (16.4 ft) RayNet to RayNet cable	A80005
10 m (32.8 ft) RayNet to RayNet cable	A62362
20 m (65.6 ft) RayNet to RayNet cable	A80006
50 mm (1.97 in) RayNet (male) to RayNet (male) cable	A80162
400 mm (1.3 ft) RayNet to SeaTalk ^{hs} (female) adaptor	A80160
RayNet cable puller 5 pack	R70014

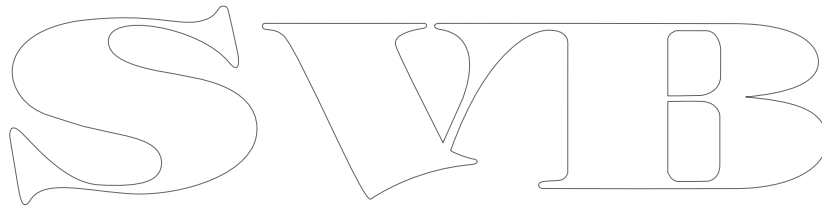

30.3 SeaTalk^{hs} network cables

Cable	Part number
1.5 m (4.9 ft) SeaTalk ^{hs} network cable	E55049
5 m (16.4 ft) SeaTalk ^{hs} network cable	E55050
10 m (32.8 ft) SeaTalk ^{hs} network cable	E55051
20 m (65.6 ft) SeaTalk ^{hs} network cable	E55052

30.4 SeaTalk^{hs} patch cables

Cable	Part number
1.5 m (4.9 ft) SeaTalk ^{hs} patch cable	E06054
5 m (16.4 ft) SeaTalk ^{hs} patch cable	E06055
10 m (32.8 ft) SeaTalk ^{hs} patch cable	E06056
15 m (49.2 ft) SeaTalk ^{hs} patch cable	A62136
20 m (65.6 ft) SeaTalk ^{hs} patch cable	E06057

SVIB

30.5 Video cables

The following video cable is required for the video in / out connector on the e95 / e97 / e125 / e127 variant multifunction displays.

Part number	Description	Notes
R70003	e-series accessory video cable	

30.6 Power cables

Cable	Part number
1.5 m (4.9 ft) Straight power and data cable	R62379
1.5 m (4.9 ft) Right angled power and data cable	R70029

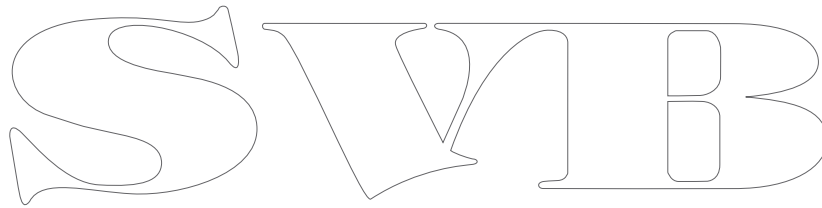
The logo consists of the letters 'S', 'V', 'I', and 'B' in a stylized, outlined font. The 'S' is on the left, followed by 'V', 'I', and 'B' on the right. The letters are interconnected and have a decorative, slightly irregular appearance.

30.7 a65 / a67 spares

Item	Part number	Notes
Trunnion (bracket) mount kit	R70147	
Front bezel	R70148	
Suncover	R70149	
Power cable 1.5m	R70157	
Right angled power cable	A80221	

30.8 e7 e7D spares

Item	Part number	Notes
Trunnion (bracket) mount kit	A62358	
Documentation pack	R62378	
Flush mount panel set	R62376	
Front bezel	R62377	
Suncover	R62365	

SVIB

30.9 e95 / e97 / c95 / c97 spares

Item	Part number	Notes
c/e series trunnion kit	R70001	
c/e series front bezel	R7004	
c/e series suncover	R70005	
c/e/ series rear bezel	R70027	
c.e series gasket	R70079	
Mounting adaptor kit — C90W/E90W	R70008	
Mounting adaptor kit — C80/E80	R70010	
Mounting screw kit	R62369	
Document pack	R70061	

30.10 e125 / e127 / c125 / c127 spares

Item	Part number	Notes
c/e series trunnion kit	R70002	
c/e series front bezel	R7006	
c/e series suncover	R70007	
c/e/ series rear bezel	R70028	
c.e series gasket	R70080	
Mounting adaptor kit — C120W/E120W	R70009	
Mounting adaptor kit — C120/E120	R70011	
Mounting screw kit	R62369	
Document pack	R70061	

SVIB

30.11 e165 Spares

Item	Part number	Notes
e165 trunnion kit	A80176	
e165 front bezel	R70126	
e165 suncover	R70127	
e165 flush mount kit	R70125	

SWIB

SWIB

Appendix A NMEA 0183 sentences

The display supports the following NMEA 0183 sentences. These are applicable to NMEA 0183 and SeaTalk protocols.

Sentence	Description	Transmit	Receive
AAM	Waypoint arrival alarm sentence		•
APB	Autopilot sentence 'B'	•	•
BWC	Bearing and distance to waypoint	•	•
BWR	Bearing and distance to waypoint — Rhumb	•	•
DBT	Depth below transducer	•	•
DPT	Depth	•	•
DSC	Digital selective calling information sentence		•
DSE	Distress sentence expansion		•
DTM	Datum reference sentence		•
GBS	GPS satellite fault detection data sentence		•
GGA	GPS System fix data	•	•
GLC	Geographic position loran C sentence		•
GLL	Geographic position latitude longitude	•	•
GSA	GPS DOP and active satellites	•	•
GSV	GPS satellites in view	•	•
HDG	Heading deviation and variation sentence		•
HDT	Heading true sentence		•
HDM	Heading magnetic sentence		•
MDA	Meteorological composite sentence		•
MSK	MSK receiver interface sentence		•
MSS	MSK receiver signal status sentence		•
MTW	Water temperature	•	•
MWV	Wind speed and angle	•	•
RMA	Recommended minimum loran C data	•	•
RMB	Recommended minimum navigation information	•	•
RMC	Recommended minimum specific GNSS data	•	•
RSD	Radar system data	•	•
RTE	Routes	•	•
TTM	Tracked target message	•	•
VHW	Water speed and heading	•	•
VLW	Distance travelled through the water	•	•
VTG	Course over ground and ground speed	•	•
WPL	Waypoint location sentence	•	•
XTE	Cross track error measured sentence		•
ZDA	Time and date	•	•

Appendix B NMEA 2000 sentences

The display supports the following NMEA 2000 sentences. These are applicable to NMEA 2000, SeaTalk^{ng} and SeaTalk 2 protocols.

Message number	Message description	Transmit	Receive	Bridge
59392	ISO Acknowledgment	•	•	•
59904	ISO Request	•	•	
60928	ISO Address Claim	•	•	•
65240	ISO Commanded address	•	•	
126208	NMEA - Request group function		•	
126208	NMEA - Command group function		•	
126208	NMEA - Acknowledge group function	•	•	•
126464	PGN List	•	•	•
126992	System time	•	•	•
126996	Product information	•	•	•
127237	Heading/Track Control		•	
127245	Rudder	•	•	•
127250	Vessel heading	•	•	•
127488	Engine parameters rapid update		•	
127489	Dynamic engine parameters		•	
127493	Dynamic transmission parameters		•	
127498	Static engine parameters		•	
127505	Fluid level		•	
128259	Speed	•	•	•
128267	Water depth	•	•	•
128275	Distance log	•	•	•
129025	Position rapid update	•	•	•
129026	COG & SOG rapid update	•	•	•
129029	GNSS position data	•	•	•
129033	Time and date	•	•	•
129038	AIS Class A Position Report		•	
129039	AIS Class B Position Report		•	
129040	AIS Class B Extended Position Report		•	
129041	AtoN position report		•	
129044	Datum	•	•	•
129283	Cross track error	•	•	•
129284	Navigation data	•	•	•
129291	Set and drift rapid update	•	•	•
129301	Time to or from mark		•	
129539	GNSS DOPs		•	
129540	GNSS Sats in view	•	•	•
129545	GNSS RAIM output message		•	
129550	GNSS differential correction receiver interface		•	
129551	GNSS differential correction receiver signal		•	
129793	AIS UTC and Date Report		•	
129794	AIS Class A Static and Voyage Related Data		•	
129801	AIS Addressed Safety Related Message		•	
129802	AIS Safety Related Broadcast Message		•	
129809	AIS class B "CS" static data report part A		•	
129810	AIS class B "CS" static data report part A		•	

Message number	Message description	Transmit	Receive	Bridge
130306	Wind data	•	•	•
130310	Environmental parameters	•	•	•
130311	Environmental parameters		•	
130576	Small craft status		•	
130577	Direction data	•	•	•
130578	Vessel speed components		•	

SVIB

Appendix C Connectors and pinouts

Power, data, and video connector

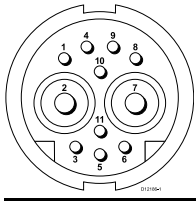

Item	Remarks
Identification	PWR / NMEA / Video
Connector type	11 pin twist-lock
Current source to network	No current sourced for external devices
Current sink from network	<ul style="list-style-type: none"> PSU: Main Power input. NMEA: No power required for interface. Video: No power required for interface.

Power, data and video cable cores and colors

Signal	Pin	AWG	Color
BATT+	2	16	Red
BATT-	7	16	Black
SCREEN	10	26	Black
NMEA1 TX+	8	26	Yellow
NMEA1 TX-	9	26	Brown
NMEA1 RX+	1	26	White
NMEA1 RX-	4	26	Green
NMEA2 RX+	3	26	Orange / White
NMEA2 RX-	11	26	Orange / Green
VIDEO IN	6	RG179 coaxial	
VIDEO RTN	5	Screen	

Network connector

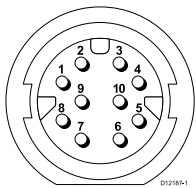

Item	Remarks
Identification	Network
Connector type	RJ45 (with suitable waterproofing)
Current source to network	No current sourced for external devices
Current sink from network	No power required for interface

Pin	Signal
1	Rx+
2	Rx-
3	Not connected
4	Not connected
5	Tx+
6	Tx-
7	Not connected
8	Not connected

Pin	Signal
9	Screen
10	Not connected

Note: Use only Raymarine RayNet cables when connecting SeaTalk^{hs} devices.

SeaTalk^{ng} connector

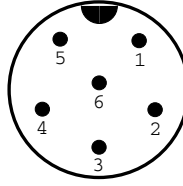

Item	Remarks
Identification	ST2/NMEA2000
Connector type	STNG
Current source to network	No current sourced for external devices
Current sink from network	<160mA (Interface drive only)

Pin	Signal
1	+12V
2	0V
3	Screen
4	CanH
5	CanL
6	SeaTalk (not connected)

Note: Use only Raymarine cables when connecting to SeaTalk^{ng}

Video in/out connector

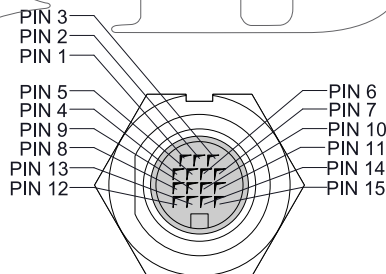

PIN	Signal
1	H-SYNC
2	V-SYNC
3	V-SYNC 0V
4	DDC CLK
5	DDC DATA
6	BLUE RTN
7	BLUE
8	Not used
9	H-SYNC 0V
10	GREEN RTN
11	GREEN
12	VIDEO IN2
13	VIDEO IN2 RTN
14	RED RTN
15	RED

Appendix D Software releases

Raymarine regularly updates its multifunction display software to introduce improvements, additional hardware support and user interface features. The table below details some of the important enhancements and which software revision they were introduced with.

Software version	Applicable product manual	Multifunction displays compatibility	Changes
V5.xx	81337-5	a65 / a67 / c95 / c97 / c125 / c127 / e7 / e7D / e95 / e97 / e125 / e127 / e165	<ul style="list-style-type: none"> • Addition of Fuel Manager including: Estimated fuel remaining, distance to empty and time to empty calculations, fuel used and fuel economy data, fuel range rings in the Chart application and low fuel alarm). • Addition of Document (pdf) Viewer application. • Addition of Slew to Cue (Auto slew thermal camera to AIS, MARPA or MOB targets). • Support for multiple thermal camera JCUs. • Thermal cameras OSD menu options now available directly from Thermal Camera application's menu. • Video application now called Camera application. • Support for networked IP cameras in the Camera application. • Ability to automatically cycle through available video / camera feeds in the Camera application. • Support for up to 5 engines in the Data application. • Improved engine data selection in the Data application. • Support for detailed engine warning alarms. • Addition of on-screen range controls to the Weather application • Ability to view images saved to SD card from the homescreen My Data menu. • Addition of Demo Video mode for retail. • Ability to record live bus messages (NMEA 0183 and SeaTalk^{ng} to SD card.
V4.xx	81337-4	c95 / c97 / c125 / c127 / e7 / e7D / e95 / e97 / e125 / e127	<ul style="list-style-type: none"> • Addition of on-screen range controls to the Chart & Radar applications. • Addition of on-screen Gain, Rain & Sea controls to Radar application. • Addition of on-screen Gain & TVG controls to Sonar application. • Addition of slider bar control adjustment. • Addition of new numeric adjustment controls. • Improved Power Key shortcuts to Brightness and Capture Screen image options
V3.xx	81337-3	c95 / c97 / c125 / c127 / e7 / e7D / e95 / e97 / e125 / e127	<ul style="list-style-type: none"> • Added support for Raymarine CP450C CHIRP Sonar Module. • Added support for AIS feature support for STEDS EAIS integration & display of SAR aircraft & SART devices. • Added limited support for Sirius Marine Weather Module. • Added Standby / PowerSave Mode. • Added support for RayRemote and RayControl Applications. • Enhanced home screen customize option permitting 9 and 12 inch MFDs to view up to 4 applications on a single page. • Default Fuel data page added. • Added Arabic language support. • Inclusion of Remote Upgrade Utility to permit the upload of software to peripheral Raymarine products using SeaTalk^{ng} / SeaTalk^{hs}. • Display of Aids To Navigation (AtoNs) AIS targets when data received on either SeaTalk^{ng} or NMEA 0183. • Added 1kW transducer support added to MFDs featuring internal ClearPulse Digital Sounder circuitry (i.e. c97/c127/e7D/e97/e127 MFDs) ... transducer output limited to 600W.

Software version	Applicable product manual	Multifunction displays compatibility	Changes
			<ul style="list-style-type: none"> • Corrected the ability to select Tide and/or Current Station using the Find Nearest feature. • Added NMEA 0183 & SeaTalkng data monitors to the diagnostics features. • Increased touch area for Alarm pop-ups and Back buttons.
V2.xx	81337-1	c95 / c97 / c125 / c127 / e7 / e7D / e95 / e97 / e125 / e127	<ul style="list-style-type: none"> • Cartography redraw performance has been improved when sharing cartography via the SeaTalkhs/RayNet network. • Added support to display fuel flow rate. • Addition of NMEA 0183 and SeaTalk^{ng} data buffer diagnostics. • Improvements to databar customization. • Ability to manually change the aspect ratio of the Video application.
V1.xx	81332-1	e7 / e7D	<ul style="list-style-type: none"> • Initial software release.

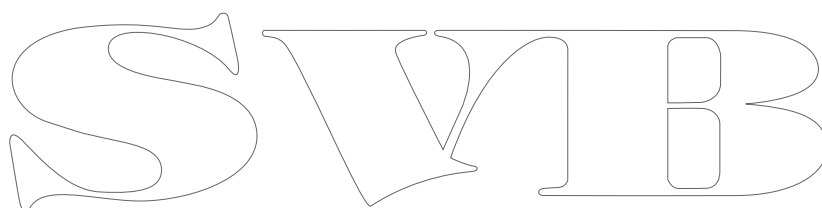

The image shows the letters 'S', 'W', and 'B' in a large, stylized, outlined font. The 'S' is on the left, the 'W' is in the middle, and the 'B' is on the right. The letters are composed of thin black outlines on a white background.

SWIB

Raymarine®
A FLIR COMPANY
SVIB