



AURIA SOLAR CO., LTD.

No. 9, Daye 1st Road, Tainan Science Park,
Sinshih Township Tainan, 74146, Taiwan R.O.C.
Tel: +886-6-5058787



INSTALLATION INSTRUCTIONS

Thin Film Photovoltaic Module



Auria Solar Co., Ltd.

Tel: +886-6-5058787

Fax: +886-6-5053371

No. 9, Daye 1st Road, Tainan Science Park,
Sinshih Township Tainan, 74146, Taiwan R.O.C.

Web-site: www.auriasolar.com



AURIA SOLAR CO., LTD.

No. 9, Daye 1st Road, Tainan Science Park,
Sinshih Township Tainan, 74146, Taiwan R.O.C.
Tel: +886-6-5058787

Table of Content	Page
1. Introduction	3
1.1 Appearance of Module	3
1.2 Appearance of Junction	4
1.3 Bypass Diode	5
1.4 Module Explosion Diagram	6
2. Safety Information	7
2.1 Warnings	7
2.2 General	7
2.3 Working Safety Instruction	7
2.3.1 Idle Voltage	9
3. Guarantee and Liability	10
4. Planning Notes	11
4.1 Place of Installation	11
4.2 Mains Feed	11
4.3 Solar Generator	11
4.4 Module install Orientation	12
4.5 Electrical Connections	13
4.6 Mounting/Fixing Frame	14
4.7 Inverter	14
4.8 Cabling	15
4.9 Disconnecter	15
4.10 Lightning Protection Unit	15
5. Handling the module	16
6. Mounting/Mounting Systems	17
6.1 Recommend mounting system	17
6.1.1 Schletter	17
6.1.2 Solarpower	18
6.1.2 Genyal	20
7. Cabling	21
8. Maintenance	23
9. Customer Service & Technical Support	24



AURIA SOLAR CO., LTD.

No. 9, Daye 1st Road, Tainan Science Park,
Sinshih Township Tainan, 74146, Taiwan R.O.C.
Tel: +886-6-5058787

1. Introduction

This installation instruction must be read carefully and understood before starting to assemble, wire or operate the modules. It firstly shows the appearance of module, junction box with bypass diode, and the fundamental information regarding mechanical, electrical assembly and safety information that user needs to be aware of are explained in details in following.

1.1 Appearance of Module (All dimensions refer to the frameless module.)

Dimension (w x l)	1,100mm x 1,300 mm
Surface Area	1.4 m ²
Net Thickness	6.8 mm (without junction box)
Weight	25 kg

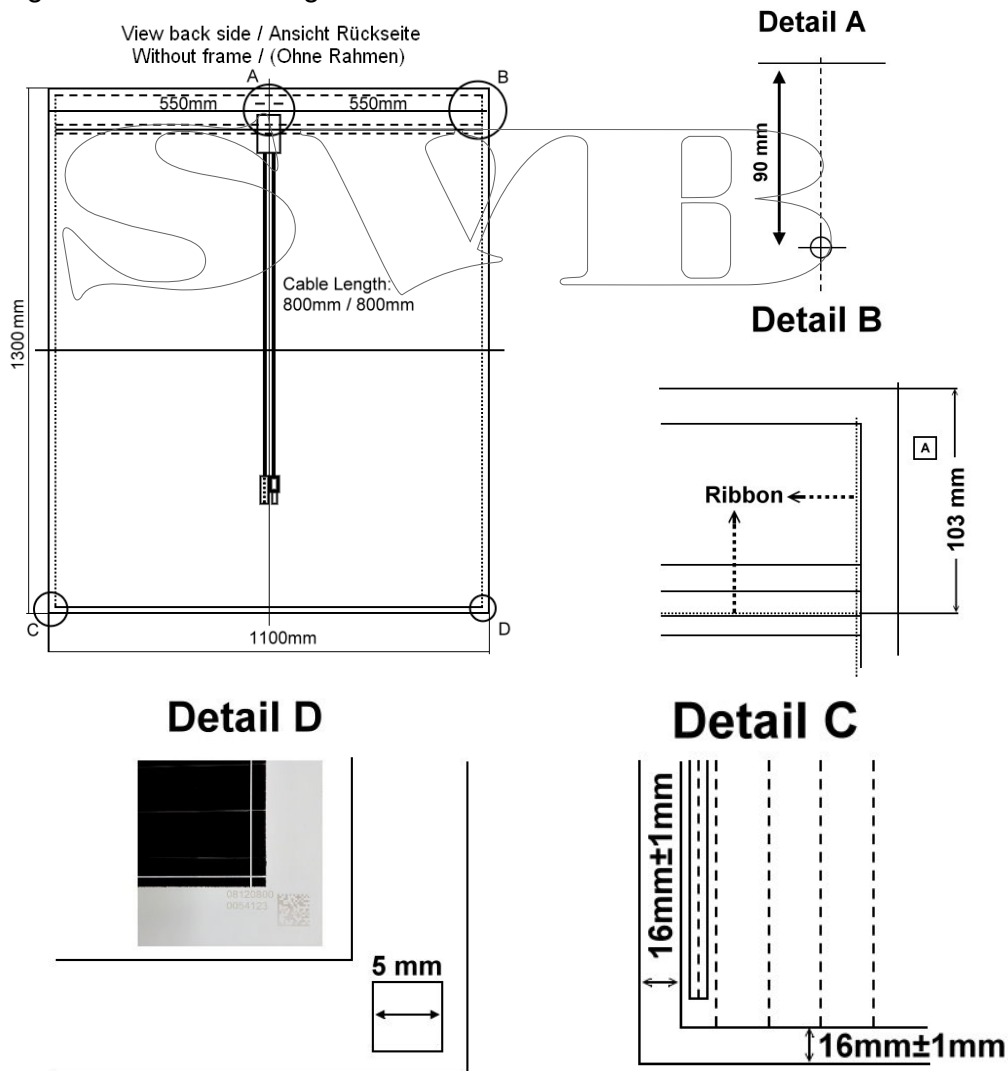



AURIA SOLAR CO., LTD.

No. 9, Daye 1st Road, Tainan Science Park,
Sinshih Township Tainan, 74146, Taiwan R.O.C.
Tel: +886-6-5058787

1.2 Appearance of Junction Box

Junction Box: PV-JB-LC2 (MC4 Compatible, with Bypass Diode)

Max System Voltage: 1000 V (Pole to Ground)

600 V (Pole to Pole)

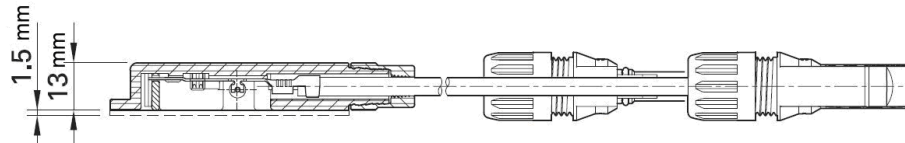
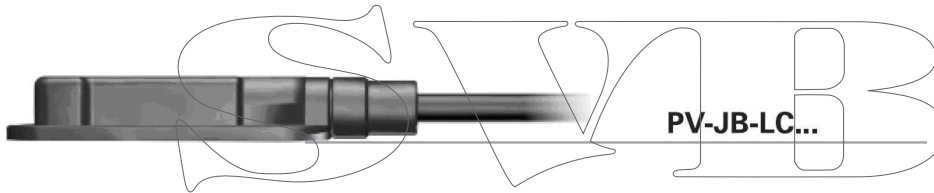
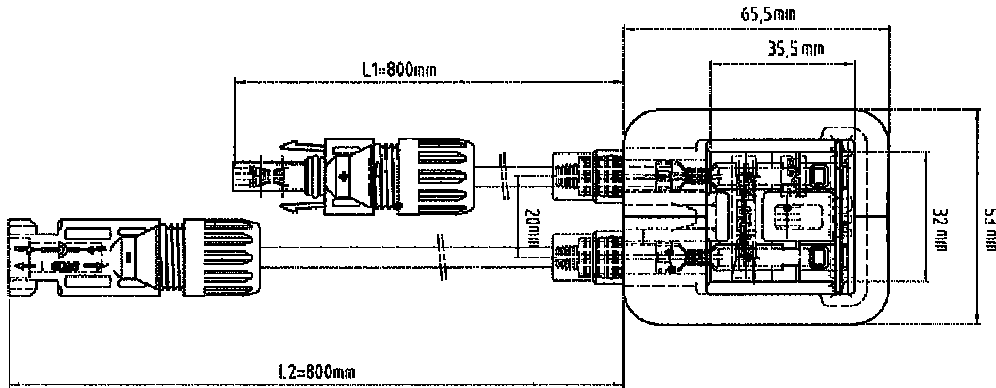

Plug MC4 (4Φ) Compatible

PLUS



MINUS



Warning!! Never disconnect or connect the pin-and-socket connections under electrical load!!

1.3 Bypass Diode (mounted in Junction Box)

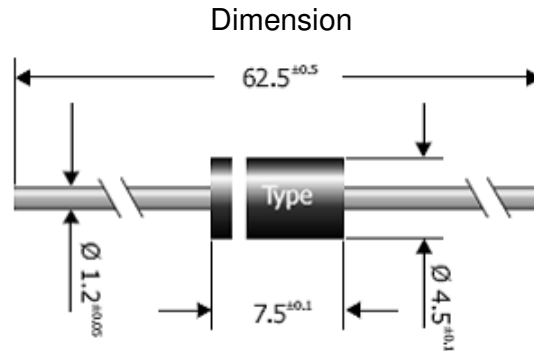

Bypass limited current: 3A

Repetitive peak reverse voltage	V_{RRM}	1300 V
Surge peak reverse voltage	V_{RSM}	1300 V
Max. average forward rectified current R-load@TA = 50 °C	I_{FAV}	3 A
Repetitive peak forward current, f >15-Hz	I_{FRM}	20 A
Junction temperature	T_j	-50 ... +150 °C
Thermal resistance junction to ambient air	R_{thA}	< 25 K/W
Thermal resistance junction to leads	R_{thL}	< 10 K/W

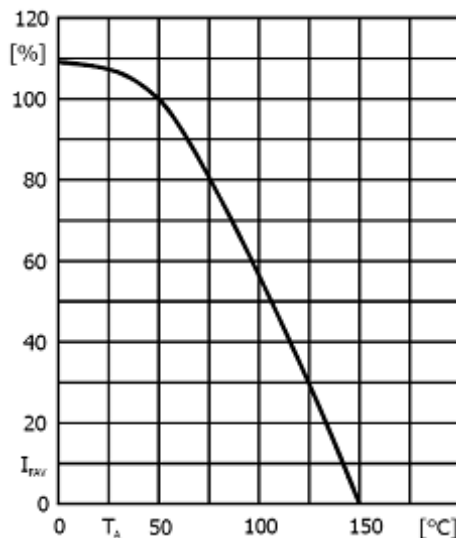

Rated forward current versus ambient temperature

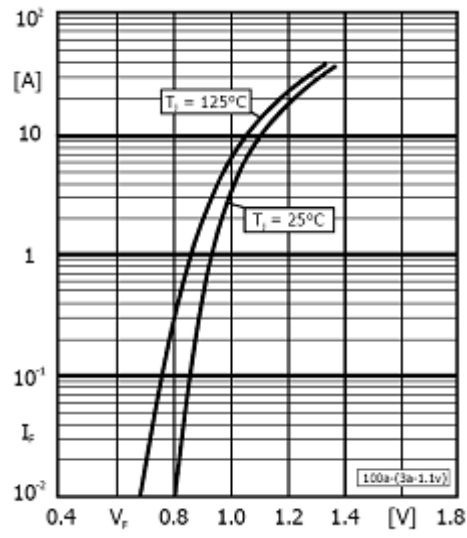

Forward characteristics (typical values)



AURIA SOLAR CO., LTD.

No. 9, Daye 1st Road, Tainan Science Park,
Sinshih Township Tainan, 74146, Taiwan R.O.C.
Tel: +886-6-5058787

1.4 Module Explosion Diagram

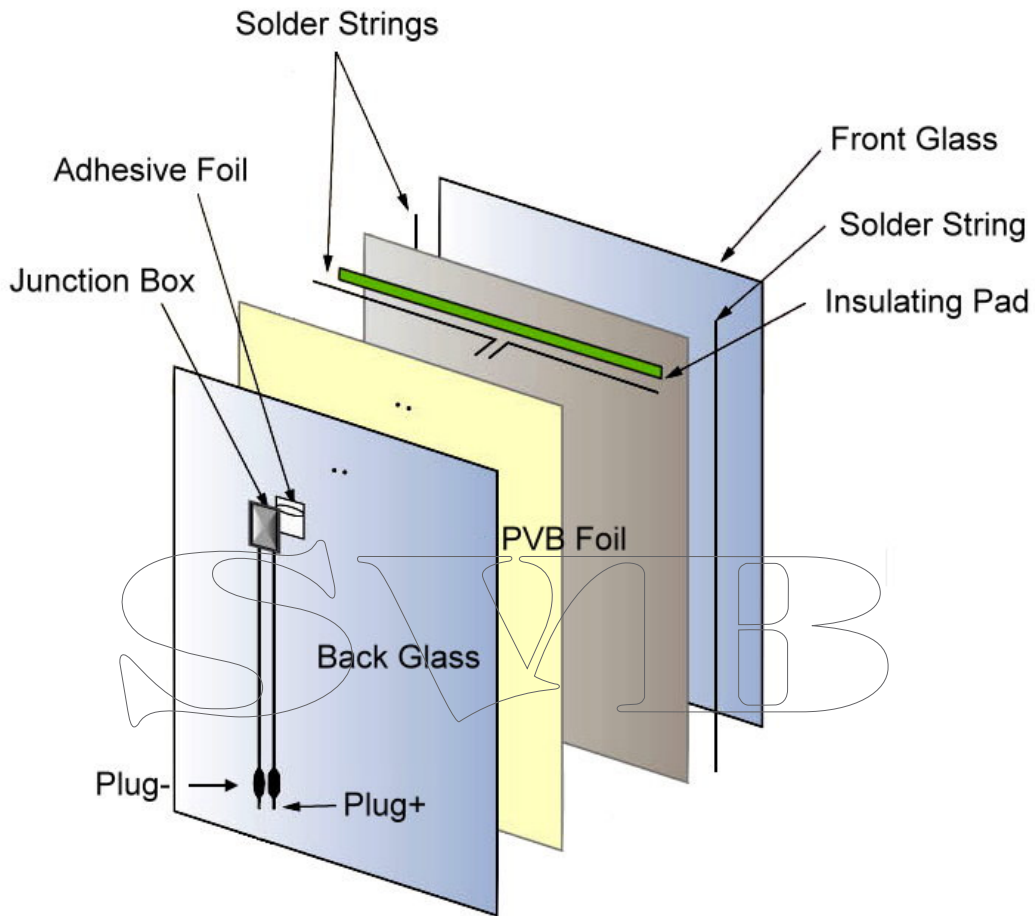



AURIA SOLAR CO., LTD.

No. 9, Daye 1st Road, Tainan Science Park,
Sinshih Township Tainan, 74146, Taiwan R.O.C.
Tel: +886-6-5058787

2. Safety Information

2.1 Warnings

The PV module produces electricity when exposed to the sun light or other light source. For your safety and the safety of others, please read the entire user guide carefully prior to installation. Also, carefully read the module data sheet provided with this product. Determine local permits, installation and inspection requirements before installing modules. The manufacture assumes no liability for damages incurred due to non-compliance of these instructions. Please also observe the instructions for the other components which make up the total PV system.

2.2 General

- Do not attempt to disassemble the module, and do not remove any attached nameplates or components! Doing so will void the warranty.
- Do not disconnect under load!
- Do not use mirrors or other hardware to artificially concentrate sunlight on the Module!

2.3 Working Safety Instruction

Be familiar with the basic principles of electricity and electrical equipment. Use properly insulated tools and appropriate protective equipment such as safety shoes and work gloves as well as protection goggles. Obtain and use a voltmeter for all systems where there is more than one module is series.

- (1) No matter where and how you want to assemble the module. You should be notice that the processing should be handling by the professional worker and also under safety protection to prevent any accident happened.
- (2) Cover module surface(s) completely with opaque material to halt the production of electricity when working on system.
- (3) Disconnect module(s) from other sources of electricity, such as batteries or inverters, when working on system.
- (4) Exercise utmost caution when working on wiring up to and including the inverter installation.



AURIA SOLAR CO., LTD.

No. 9, Daye 1st Road, Tainan Science Park,
Sinshih Township Tainan, 74146, Taiwan R.O.C.
Tel: +886-6-5058787

- (5) For safety mounting the module, please mount the module with proper tool and also confirm if the place for assembling is safe.
- (6) Avoid contact with terminals when modules are exposed to light. Do not remove any parts originally installed or disassemble the module.
- (7) Never walk, sit and put any thing or do any dangerous activation onto the module not only the surface also the back glass to avoid damaging the module or hurting anyone.
- (8) Please check the load and circuit arrangement before assembling the module for ensure user can gain the max power output, but not break the power supply system.
- (9) Do not attempt to install or use a module with broken front cover glass or a damaged back glass.

The modules are compliant for application class A: Hazardous voltage (IEC 61730: higher than 50V DC; EN 61730: higher than 120V), hazardous power applications (higher than 240W) where general contact access is anticipated (Module are compliant for safety through EN IEC 61730-1 and -2 within this application class are considered to meet the requirements for safety class II).

Unpacking the modules and storage:

Utmost care is required when handling solar electric modules. Use care when unpacking, transporting and storing the modules:

- a) Transport modules in an upright position and carry modules with both hands (Do not use the connection socket as a handle).
- b) Ensure modules do not bow under their own weight and do not place modules on top of each other.
- c) Do not mark using sharp tools and keep all electrical contacts clean and dry.

This module has a Class C Fire Rating, and it must apply with appropriate fire resistance to install over a roof. Consult your local building department to determine approved roofing materials. Do not install this module integral with a roof or wall of a habitable structure.



AURIA SOLAR CO., LTD.

No. 9, Daye 1st Road, Tainan Science Park,
Sinshih Township Tainan, 74146, Taiwan R.O.C.
Tel: +886-6-5058787

2.3.1 Idle Voltage

Working on uncovered solar modules is working under current. As soon as light meets the solar module, you can expect full idle voltage at the cable ends of the module or the cable ends of the already switched strings. The more modules switched in the row (switched in series) the greater the idle voltage.

Number of modules x Module idle voltage = **Overall voltage**

The maximum permitted system voltage of the solar generator and the maximum permitted DC voltage of the inverter may not be exceeded by overall voltage.

Caution!!!

The protective clamp voltage range of 120V is usually exceeded.

Mounting of the module may be carried out by persons not trained for the purpose, but the cabling, connections and implementation may only be carried out by electronic specialists.

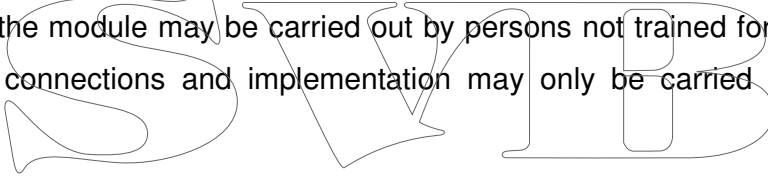

For the alternating current connection to the public supply network (cabling between the inverter and the house connection and the mounting of the supply meter in a DIN suitable meter requires the electrician to be authorized by the appropriate power supplier/mains operator.



AURIA SOLAR CO., LTD.

No. 9, Daye 1st Road, Tainan Science Park,
Sinshih Township Tainan, 74146, Taiwan R.O.C.
Tel: +886-6-5058787

3. Guarantee and Liability

Limited Warranty

- Material and Workmanship Warranty: 5 Years
- 90% of the minimal rated Power Output: 10 Years
- 80% of the minimal rated Power Output: 20 Years

Normally, the module under valid condition and general terms could work regularly. Guarantee and liability claims are excluded if they can be traced. All guarantee and liability have to follow with **Auria Solar Warranty Policy**.

1. Failure to comply with the installation or handling procedures and precautions described in user manual, caution labels, installation instruction or other written information provided by AURIA SOLAR.
2. Mounting under incorrectly or with no functioning safety and protective mechanisms; unprofessional assembling or handling of the modules.
3. Application for unusual purposes; ignore the relevant valid regulations and the generally application rules of technology.



AURIA SOLAR CO., LTD.

No. 9, Daye 1st Road, Tainan Science Park,
Sinshih Township Tainan, 74146, Taiwan R.O.C.
Tel: +886-6-5058787

4. Planning Notes

4.1 Place of Installation

Environmental influences at the place of installation may have a negative effect on the performance of the unit or cause damages to the modules. This includes, for example, aggressive fumes as can be found in the vicinity of chemical plants, but also in agriculture near, pig sties, chicken runs and in the vicinity of open liquid manure storage. The modules should also not be used in locations with considerable dust pollution (for example, in the vicinity of cereal stores, cement works, etc.). The modules may **NOT** be used near to the coast (no contact to salt water or air containing salt water (spray)) as this may lead to the glass disease (blinding). For safety reasons the modules may also **NOT** be used in the vicinity of easily flammable gasses.

4.2 Mains Feed

The feeding from the inverter into the public network must be carried out by an authorized specialist. The connection conditions of the relevant supply company must be observed.

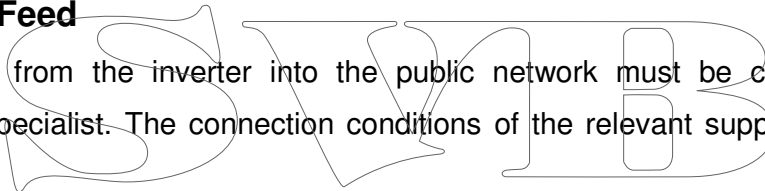

4.3 Solar Generator

Since the life expectancy of the module is upwards of 30 years, the state of the roof should be examined. All modules to a given inverter should have the same orientation and the same angle otherwise this may lead to loss of performance. The entire generator field should be free of shadows and thus take into account the lowest height of the sun in winter. Even minor partial shadows cast by chimneys, dormers; high-voltage and antenna masts, trees, neighboring buildings etc. can have a considerable effect on performance.

For installation the laser scribed line must run vertically with respect to the ground, i.e. solar modules need to be set up on lower edge.

4.4 Module install Orientation

Case A

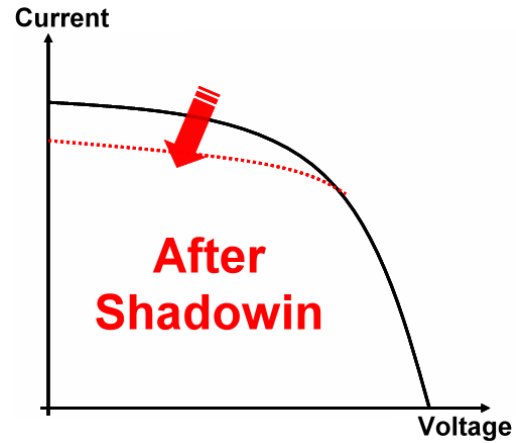

Case B

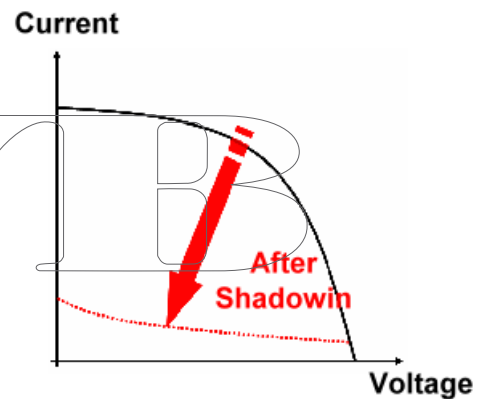
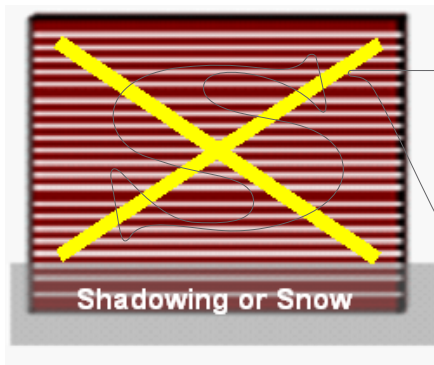

1. The best way for user gets the max power output is to put the module without any shadowing.
2. The above two cases show that if the module cannot be avoid the shadowing effect, what can be done for having a better power output is putting the module in the right position.
3. The better way is to watch the strongest irradiation of sunlight for the chosen place if you have several choices.
4. Please set modules away from the area with dust pollution or other place easy fallen something onto the surface.
5. Do not use modules near to the coast, because the salt water or air containing salt water might affect the lifetime of total module.
6. Do not put modules close to any dangerous places with easily flammable gas.
7. Inclination angle should be $> 10^\circ$ for self-clean by raining.



AURIA SOLAR CO., LTD.

No. 9, Daye 1st Road, Tainan Science Park,
Sinshih Township Tainan, 74146, Taiwan R.O.C.
Tel: +886-6-5058787

4.5 Electrical Connections

Modules may be connected in series and/or parallel to achieve the desired electrical output as long as certain conditions are met.

The definitive number of parallel connected modules depends on the plant topology (inverter sizing according to known practice, protection means, etc.).

Important! Blocking diodes or fuses at the head of the strings shall be used for reverse current protection when more than 3 strings are connected in parallel. If no particular protection is foreseen not more than three (3) modules or strings respectively should be connected in parallel. Never exceed the limit of 1000V on connected modules (maximum reverse-current protection of 3 Amps!)

Important! Do not use the inverter with no transformer connecting. For optimal performance, AURIA SOLAR modules must only be used in configurations where the negative polarity of the PV module is connected to ground (use of inverter with transformers with negative grounding). Failure to comply with this requirement will reduce the performance of the system and invalidate AURIA SOLAR warranty for

- a) Only connect series solar power modules of the same type and power category.
- b) The solar cables are equipped with the MultiContact solar-look pin-and-socket connector system for PV.
- c) Be absolutely sure to observe the modules' polarity. Reverse polarity might cause destruction of the protective diodes.



AURIA SOLAR CO., LTD.

No. 9, Daye 1st Road, Tainan Science Park,
Sinshih Township Tainan, 74146, Taiwan R.O.C.
Tel: +886-6-5058787

Notice 1 : Max System Voltage: 1000 V (Pole to Ground)
600 V (Pole to Pole)

Notice 2 : The initial value for the output power of modules is higher than the nominal values. Please take it into account when you choose inverter.

Light Induced Degradation factor: 15%

Stabilization output power=Initial output power * (1-LID factor)

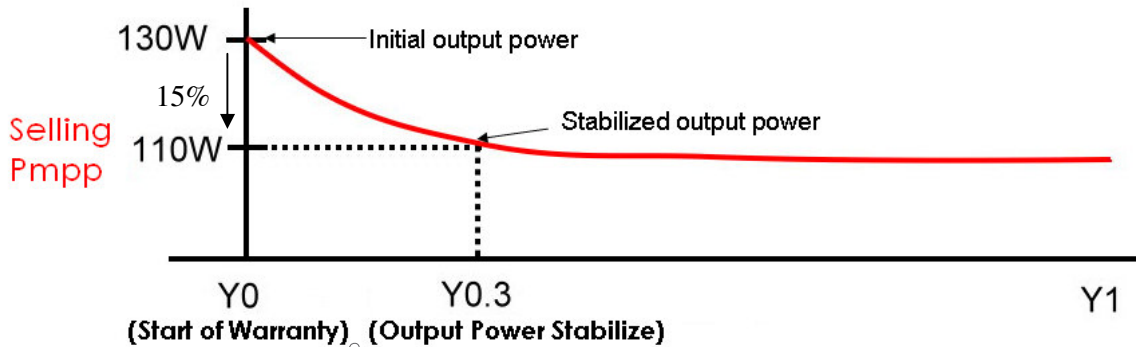

Notice 3 : The number for series or parallel connecting of modules should be under the limited numbers with safety capacity of electrical power.

Notice 4 : Sunny, cool weather and reflection from snow and water can increase current and power output. Therefore, the values of Isc and Voc marked on the module should be multiplied by a factor of 1.25 when determining component voltage ratings, conductor ampacities, fuse sizes, and size of controls connected to PV output.

4.6 Mounting/Fixing Frame

Only use rust-free materials like aluminium or stainless steel. Planning and construction guides of the frame manufacturer must be observed.

4.7 Inverter

Inverters without transformers are NOT permitted for use with Auria thin film modules.

Pay attention to the planning notes in the operating instructions for the inverter.

When setting up the inverter note that the initial values of the module (in particular, the idle voltage) are approximately 15% higher than the nominal values (stabilised values).

4.8 Cabling

Plan the entire cabling very carefully. If the cable cross-sections are too low this leads to



AURIA SOLAR CO., LTD.

No. 9, Daye 1st Road, Tainan Science Park,
Sinshih Township Tainan, 74146, Taiwan R.O.C.
Tel: +886-6-5058787

cable losses which have a direct effect on the performance of the unit. The permitted current carrying capacity of the cable may not be exceeded as this would lead to excessive heating and possibly even to cable fire. Observe the relevant guidelines and regulations. Only weather and UV-resistant solar cables may be used to cable the solar generator.

4.9 Disconnecter

In Germany, direct current string cables may only be connected via permitted disconnectors to the inverter. Insofar as the planned inverters do not have these disconnectors, the string lines must be switched via external permitted disconnectors.

4.10 Lightning Protection Unit

The installation of the photovoltaic unit does not necessarily require the installation of the building lightning protection unit. But you should make sure that you consult a specialist for lightning technology in order to find out. In principle, if the building already has a lightning protection unit, the photovoltaic unit can generally be incorporated. If the photovoltaic unit cannot be incorporated into a lightning protection unit, all metallic components of the photovoltaic unit and the frame should be incorporated into the main equipotential bonding of the building.



AURIA SOLAR CO., LTD.

No. 9, Daye 1st Road, Tainan Science Park,
Sinshih Township Tainan, 74146, Taiwan R.O.C.
Tel: +886-6-5058787

5. Handling the module

The Auria thin film modules are glass-glass module (this means both the front and rear are made of glass) and must be treated as such.

Observe the following notes:

- Keep the photovoltaic unit in the delivery box until it is ready to be mounted
- Do not put too much pressure on the module surface and avoid bending forces as this may break it.
- Do not stand on the module
- Do not subject the module to constant movement or vibrations
- It is not permitted to bundle sunlight onto the module surface, as this can increase the temperature of the module to levels that are not allowed.
- The connection socket on the rear of the module may not be opened.
- Damaged solar modules may not be mounted.
- Ensure that no flammable gases can develop in the vicinity of the mounting location
- Avoid subjecting the glass to bumps and bangs
- Do not pull at the connection cable
- Ensure that the solar connector is not able to come into contact with water or moisture when storing or mounting the module. This can lead to oxidization of the contacts and create transfer resistance which leads to loss of performance or to burning of the solar connector.
- With modules that have mounting frames, do not damage or remove these frames.
- Do not damage the connection cable by cutting, trapping it in the mounting frame, or bending severely, this could lead to loss of power or to an electric shock.
- Do not damage or remove the type label or serial number.
- The modules must be mounted in such a way that they are not standing in water.



AURIA SOLAR CO., LTD.

No. 9, Daye 1st Road, Tainan Science Park,
Sinshih Township Tainan, 74146, Taiwan R.O.C.
Tel: +886-6-5058787

6. Mounting/Mounting Systems

AURIA thin layer modules are designed for roof, façade and open space systems. Our thin layer modules can be purchased just as modules.

AURIA Solar takes no responsibility for damages of any type caused by the use of unsuitable or lacking mounting systems. Before starting with the mounting process, the generator field on the roof must be calibrated in order to determine the optimum position.

Mounting systems with module clamp technology and with placement technology may both be used. When using frameless modules, the module may not be clamp directly using metal clamps, only clamps which hold both sides of the module in water-proof rubber may be used. (laminated clamps)

When selecting the clamps take the thickness of the module/glass into account.

If the frameless glass-glass module is compressed too much, the glass may break.

The rail carrying system must be laid out evenly otherwise this may lead to tension in the modules and thus to a break of the modules.

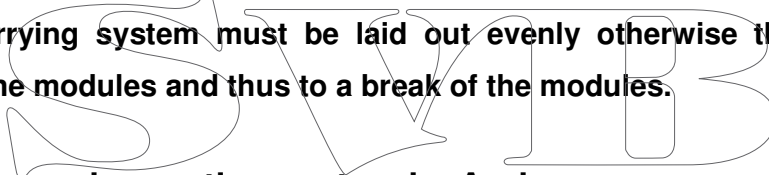

6.1 Recommend mounting system by Auria:

6.1.1 Schletter

Due to the given environmental conditions (wind uplift, snow load, dynamic loads, etc.) module sizes are very limited in case of predetermined glass thicknesses, Schletter GmbH is able to develop suitable bonding techniques in cooperation with several module producers, in order to connect even these extensive modules mechanically to the substructure in an optimum manner. The system **OptiBond** © offers the components and technologies for a optimized and thereby cost fastening of unframed bid modules in big photovoltaic planes.



AURIA SOLAR CO., LTD.

No. 9, Daye 1st Road, Tainan Science Park,
Sinshih Township Tainan, 74146, Taiwan R.O.C.
Tel: +886-6-5058787

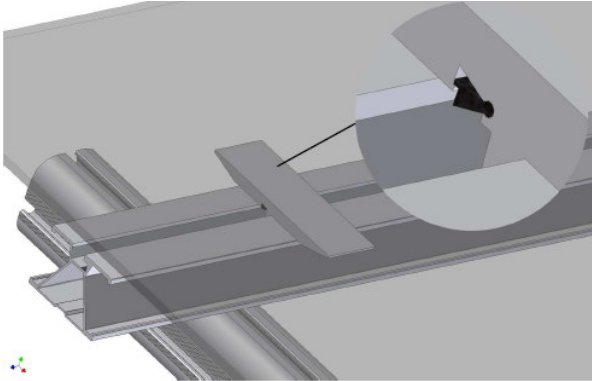

Contact information of Schletter

Schletter GmbH

E-mail: solar@schletter.eu

TEL: +49 8072 9191-200

FAX: +49 8072 9191-9200

6.1.2 Solarpower

Solarpower GmbH conceives and manufactures fix elevations based on Eurocode 1. The Solarpower steel construction corresponds to the norms DIN 1055 & DIN 18800, it is hot dip galvanized. Optionally a duplex coating can be applied. Meanwhile, Solarpower has passed TUV certificate from TUV-Saarland and is delivered for every project after realization.



AURIA SOLAR CO., LTD.

No. 9, Daye 1st Road, Tainan Science Park,
Sinshih Township Tainan, 74146, Taiwan R.O.C.
Tel: +886-6-5058787



Technical Data	Module thin film Auria
Kind of Installation	4 rows vertical
Table length (m)	Endless
Table depth (m)	4.46m
Module edge over ground (m)	0.50 to 1.50m
Upper module edge over ground (m)	2.73 to 3.73m
Blade angle of the modules	30° or others
Module performance (Wp)	>100 Wp
Module dimensions	1300*1100*6.8mm
Kind of module	Micromorph
Total performance per table	Depends on the length of the table
Kind of module clamps	Patented Solarpower plastic module clamps
Allowable wind loads	1-4
Allowable snow loads	1-2
Material of the construction	Galvanized Steal

Contact information of Solarpower

Solarpower GmbH

Name: Sina Glass

E-mail: sina.glass@solarpower-gmbh.de

TEL: +49(0)3741-4154-0

FAX: +49(0)3741-4154-54



AURIA SOLAR CO., LTD.

No. 9, Daye 1st Road, Tainan Science Park,
Sinshih Township Tainan, 74146, Taiwan R.O.C.
Tel: +886-6-5058787

6.1.3 Genyal

A Spain based mounting system company, which is able to provide flexible structure to adapt any kind of modules. Parts manufactured with Aluminum and Stainless steel DIN 1.4301/ AISI304, which provide a high corrosion resistance.

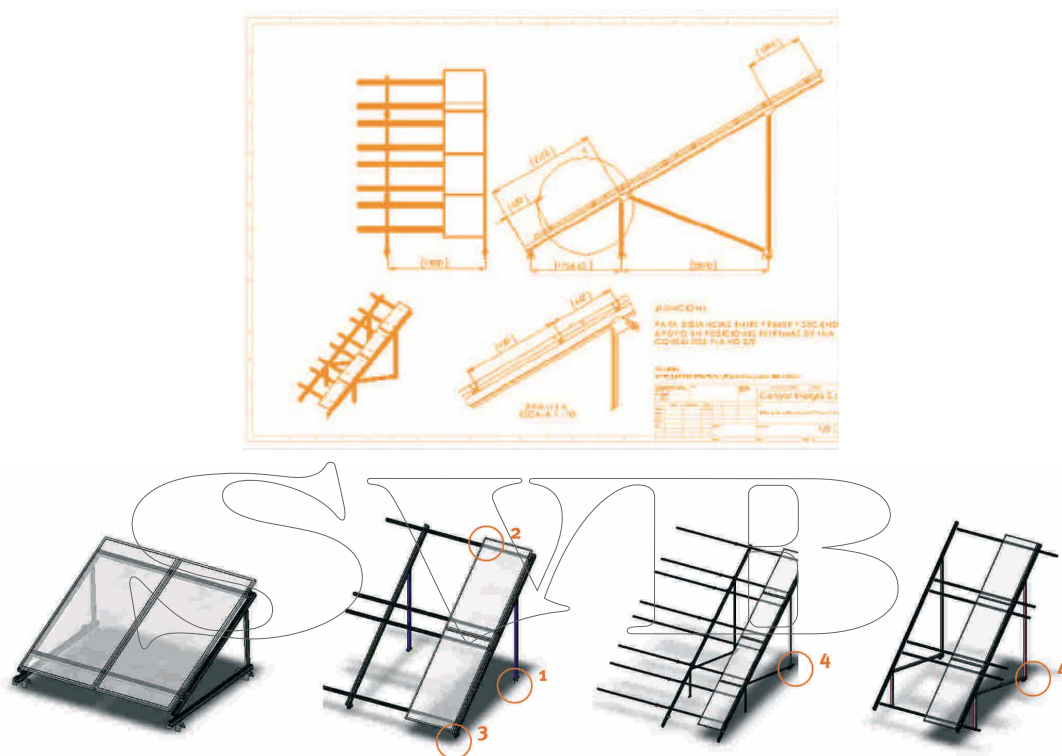

Contact Window of Genyal:

Genyal Soluciones De Energia, S.A.

Name: Antonio Dominguez

E-mail: antonio@genyalenergia.com

Tel: +34-986911424

Earthing the mounting system

All metal components of the generator and the mounting system must be incorporated into the main equipotential bonding of the building. For this purpose, all of the metal components are connected in a way that conducts electricity and connected to the building equipotential bonding rail using an earthing cable of at least 16 qmm.

When mounting anywhere other than Germany, the regulations of the relevant country must be taken into account.



AURIA SOLAR CO., LTD.

No. 9, Daye 1st Road, Tainan Science Park,
Sinshih Township Tainan, 74146, Taiwan R.O.C.
Tel: +886-6-5058787

7. Cabling

For the string cabling only use UV and water-resistant solar cable with a cross-section of at least 4 qmm. With longer cable length, a greater cable cross-section may be necessary. To prevent loss of performance caused by cable losses, the cable cross-section must be precisely calculated.

All Auria thin film modules are fitted with MC 4 solar connectors.



The polarity is shown on the connectors.

When fixing the solar connectors and couplings to the string cabling, only original crimping tools may be used.

Check the polarity of the string cables before you connect these to the inverter. Continue to check the plausibility of the string voltages before taking the system into operation.

Only modules of the same type may be switched together.

Series switching: In order to increase the voltage, several modules can be switched in a row to form a string.

Here, the maximum DC voltage of the inverter and the maximum system voltage of the modules may not be exceeded. Connect the cables with the positive connector of one module to the negative connector of another. The string cables to the inverter are then connected to the first and the last modules.

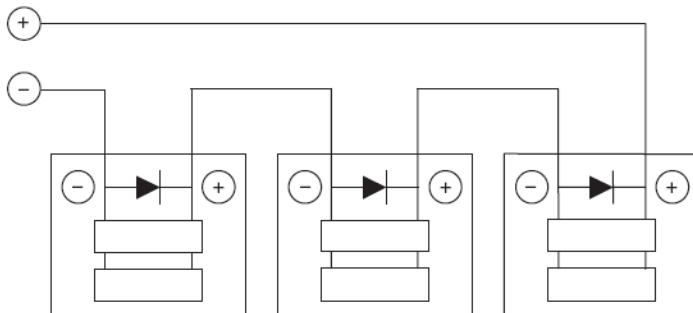



AURIA SOLAR CO., LTD.

No. 9, Daye 1st Road, Tainan Science Park,
Sinshih Township Tainan, 74146, Taiwan R.O.C.
Tel: +886-6-5058787

Parallel switching: To ensure optimum use of the inverter, it may be necessary to switch several strings in parallel to increase the current level. If more than two strings are switched in parallel, blocking diodes must be switched in the individual strings to protect against too high back current.

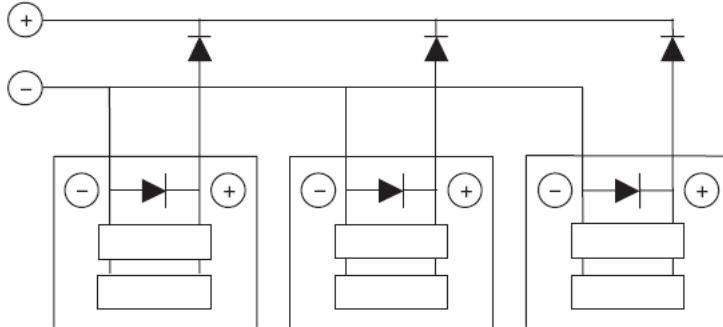

The appropriate diode boxes can be ordered from AURIA Solar.

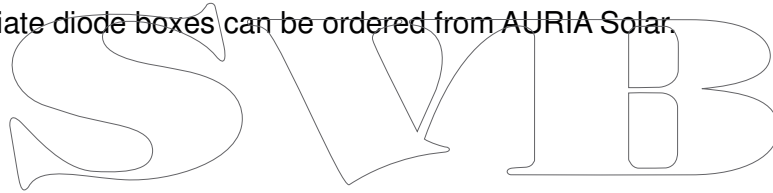



AURIA SOLAR CO., LTD.

No. 9, Daye 1st Road, Tainan Science Park,
Sinshih Township Tainan, 74146, Taiwan R.O.C.
Tel: +886-6-5058787

8. Maintenance

Please remember that keep the surface clean is the most important thing for you get the max power output. We do suggest regularly checking the system for functionality and for signs of damages and broken parts of glass in order to catch any potential disturbances as early as possible and repair them.

The photovoltaic generator is generally kept clean with water running off it. Suggest to set an angle of at least 10 degrees for you convenient using. The modules can be cleaned with water and a soft cleaning cloth.

Do not use harden or abrasive cleaning agents that might scratch the surface of the glass.

The glass of the module may not be scratched.

For cleaning, use water that is low on lime and ensure that no limescale is able to build up on the glass surface.

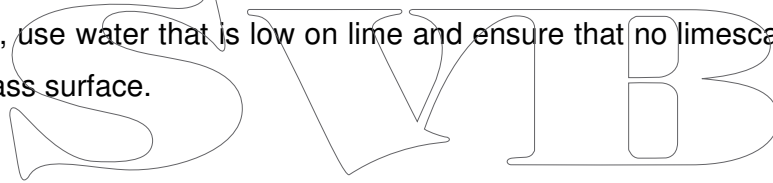



AURIA SOLAR CO., LTD.

No. 9, Daye 1st Road, Tainan Science Park,
Sinshih Township Tainan, 74146, Taiwan R.O.C.
Tel: +886-6-5058787

9. Customer Service & Technical Support

For further service and information please contact as following:

Web-Site: www.auriasolar.com

E-Mail: auria_service@auriasolar.com

Tel: +886-6-505-8787

Fax: +886-6-505-3371

No.9, Daye 1st Road, Tainan Science Park,
Sinshih Township Tainan 74146, TAIWAN, R.O.C.

