

User Manual

safe
SEA E100

safe
SEA E100G

Emergency Position
Indicating Radio
Beacons

SVIB
English



© 2012 Ocean Signal Ltd



The technical data, information and illustrations contained in this manual were believed to be correct at the time of print. Ocean Signal Ltd reserve the right to change specifications and other information contained in this manual as part of our continual improvement process.

No part of this manual may be reproduced, stored in a retrieval system or transmitted in any form, electronic or otherwise, without the prior permission of Ocean Signal Ltd.

No liability can be accepted for any inaccuracies or omissions in this manual.

Ocean Signal® and SafeSea® are registered trademarks of Ocean Signal Ltd.

IN CASE OF EMERGENCY



WARNING: USE ONLY IN SITUATIONS OF GRAVE AND IMMINENT DANGER



- REMOVE THE EPIRB FROM ITS MOUNTING OR HOUSING
- TO MANUALLY ACTIVATE THE EPIRB:

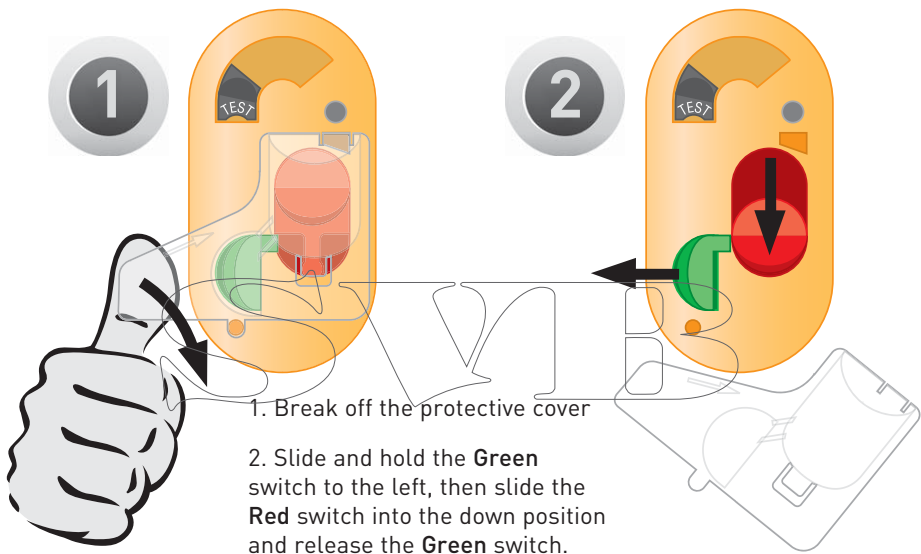

- REMOVE THE LANYARD COVER
- HOLDING ON TO THE FREE END OF THE LANYARD, THROW THE EPIRB INTO THE WATER

NOTE: Refer to section 4.3 for deactivation instructions.

CONTENTS

1	General	5
1.1	Introduction	5
1.2	Registration	5
1.3	Programming Details	6
2	E100/E100G Overview	7
3	Installation	8
3.1	Location	8
3.2	Float Free Housing	8
3.2.1	Loading the EPIRB	9
3.3	Mounting Bracket	10
3.3.1	Loading the EPIRB	10
4	Operation	11
4.1	Manual Activation	11
4.1.1	Deployment From an Enclosure	11
4.1.2	Deployment From a Bracket	12
4.1.3	Manual Activation	12
4.2	Automatic Activation	13
4.3	Deactivation	14
4.3.1	Deactivation from Manual Activation	14
4.3.2	Deactivation from Automatic Activation	14
5	False Alerts	15
5.1	Disabling the EPIRB	15
6	Maintenance	16
6.1	Testing	16
6.1.1	Self Test Mode	16
6.1.2	GPS Test Mode	17
6.2	Inspection	18
6.3	Battery Replacement	19
6.4	HRU Replacement	20
7	Appendix	21
7.1	System Overview	21
7.1.1	COSPAS/SARSAT System	21
7.1.2	GPS System	21
7.2	Specifications	22
7.3	Accessories	23
7.4	Approvals	23
7.5	Service & Warranty	24
7.6	Record of Programming Details	25

1 GENERAL

1.1 Introduction

This manual provides valuable information for the installation, operation and routine maintenance of both the:

**SafeSea E100 EPIRB
&
SafeSea E100G EPIRB with GPS**

Please read this manual completely before using your EPIRB. Parts of this manual apply to the E100G only.

1.2 Registration



THE OWNER OF THIS 406MHz EPIRB MUST REGISTER IT WITH THE APPROPRIATE NATIONAL AUTHORITY.



FAILURE TO REGISTER THIS EPIRB MAY RESULT IN A FINE, SLOWING THE RESCUE PROCESS OR EVEN LOSS OF LIFE.

All 406MHz EPIRBs are programmed with a unique identity number (UIN), which is based upon the country of registration. This is normally the country to which the vessel is flagged. Registration provides the Search and Rescue authorities with the correct emergency contact details, which will speed up the rescue process.

For UK registrations go to:

www.dft.gov.uk/mca/mcga07-home/emergencyresponse/mcga-searchandrescue/epirb/mcga-sar-epirb-online.htm

For US registrations go to:

<https://beaconregistration.noaa.gov/rgdb/>

Once registration has been performed you should receive a “decals” sticker which must be affixed to the area on the EPIRB marked “Attach proof of registration in this area”. This decal is your proof of registration.

Useful registration contacts are:

UK EPIRB Registry

HM Coastguard (Southern)
Pendennis Point
Castle Drive
Falmouth
TR11 4WZ

US EPIRB Registry

NOAA/SARSAT
NSOF, E/SP3
4231 Suitland Road
Suitland, MD 20746
USA

This EPIRB is a radio transmitter - as such, your existing radio license must be updated to include this EPIRB.

When an EPIRB is transferred to a new vessel, the EPIRB must be re-programmed to include the relevant information as required by the country controlling the new vessel.

In the US, Vessel owners should advise NOAA in writing upon change of vessel or EPIRB ownership, transfer of EPIRB to another vessel, or any other change in registration information.

Changing the country to which the vessel is flagged will result in the EPIRB needing to be re-programmed, as the EPIRB UIN also contains the country code.



It is very important that your EPIRB is registered with your National Authority. The registration information will ensure that the rescue authorities quickly identify the type of vessel they are searching for and make contact to ensure the alert is not a false alarm. Although failure to register your beacon will not stop you being rescued, it may cause unnecessary delays and effort in the rescue centre.

1.3 Programming Details

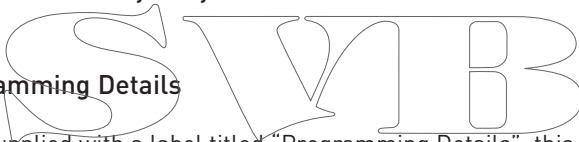

Your EPIRB is supplied with a label titled "Programming Details", this contains areas where the programming details of the EPIRB can be marked. This information includes:

1. UIN (Unique Identity Number).
2. Vessel Name.
3. MMSI.
4. Country.
5. Call Sign.

If this label has not been provided with the EPIRB information pre-inserted then the user should write this information on the label using a UV stable indelible pen. The UIN (15digit HEX code) can be found on the programming certificate.

Affix the label to the left side of the EPIRB in the area provided, then place the clear protective label provided over the first label.

It is recommended that this information is also copied into the section provided at the back of this manual.

2 E100/E100G OVERVIEW

- 1. Strobe Lights
- 2. Lanyard Attachment Point
- 3. Programming Details Label
- 4. Battery Compartment
- 5. Test Switch
- 6. Indicator LED
- 7. Tear off tag
- 8. Interlock Switch
- 9. Activation Switch

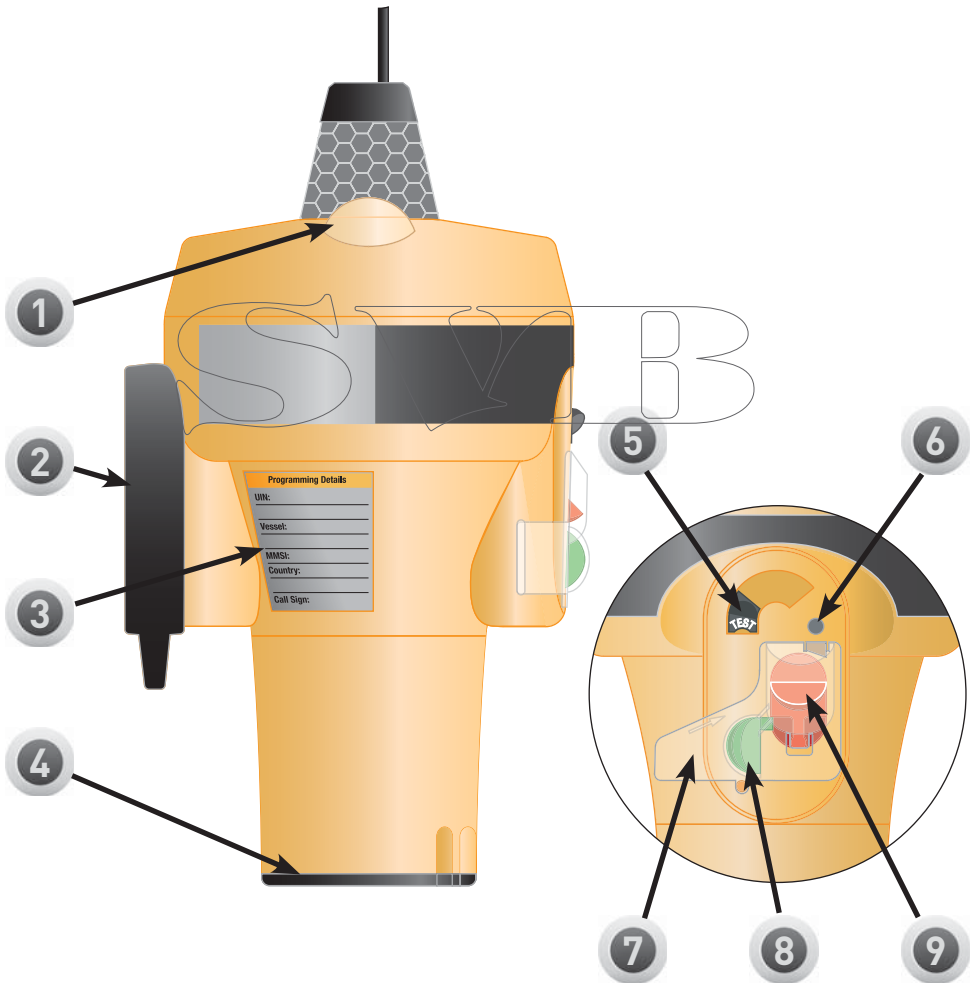

3 INSTALLATION

- ❗ Failure to follow the following installation guidelines may cause the EPIRB to operate incorrectly.
- ❗ Do not mount the EPIRB closer than 1 metre to any steering compass as this may affect the accuracy of the compass.
- ❗ Keep the E100 away from any strong magnetic sources such as loudspeakers, compass compensation magnets, etc.

3.1 Location

The location selected must be sufficiently robust to support the weight of the entire unit. Exposure to the elements and surrounding hazards along with vibration should also be taken into consideration when choosing the location. Ensure that the mounting location allows easy access to the EPIRB for maintenance and servicing.

To ensure that the EPIRB will always float free from the sinking vessel ensure that the float free housing is located high up on the superstructure, free from any obstructions and located in a position that it will not be trapped, regardless of the angle the sinking vessel may be in.

Ensure the EPIRB it is mounted with the antenna facing upwards.

3.2 Float Free Housing

Using the dimensions shown, use the four No10 x 1" screws supplied to secure the float free housing to the chosen structure.

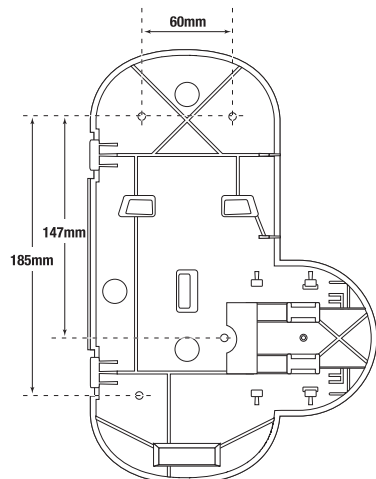

3.2.1 Loading the EPIRB



When replacing the EPIRB in the Float Free Housing please ensure that the unit is clean and dry. The area around the activation controls and the lanyard should be free from water and dirt to ensure reliable operation.

The EPIRB is held in place inside the Float Free Housing by the Hydrostatic Release Module (HRU) which locks into position using a spring.

If it is necessary to replace the EPIRB into the Float Free Housing (after maintenance or testing etc):

1. Pull the HRU back as shown (right).
2. Load the EPIRB, controls facing up, into the location seat, ensuring to carefully fold the antenna back behind the EPIRB.
3. Gently lower the HRU back into the locked position - this also holds the EPIRB in place.
4. Place the housing cover over the back, by placing the locating holes (on the side of the housing) over the clips.
5. Push and rotate the housing release knob into the locked position (right).
6. Complete the provided identification label using a UV stable indelible pen. Fit to the side of the ARH100 cover left hand side in an easily visible position and use the clear protective label to cover it. Clearly mark the expiry date on the HR1E and on to the separate label provided using indelible pen. Fix the label to the housing in the rectangular recess and cover with the clear protective label.

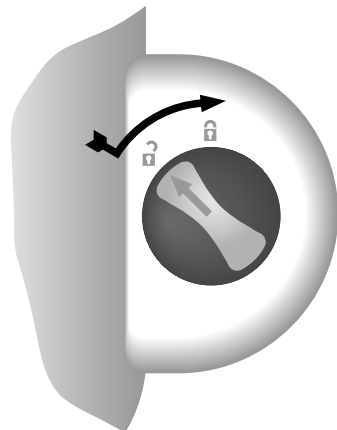
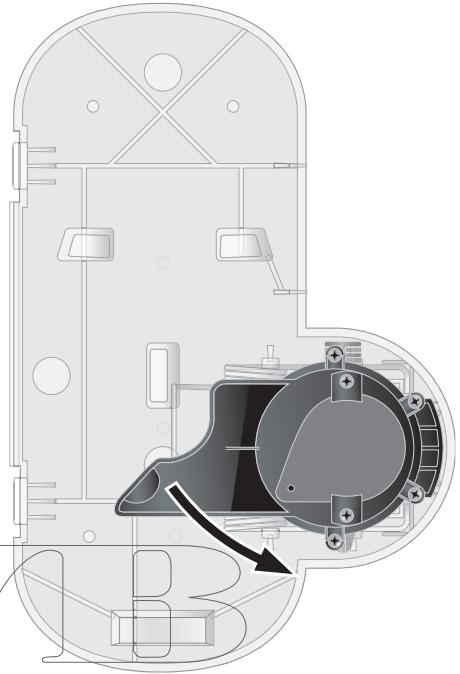

3.3 Mounting Bracket

The E100/E100G is supplied as standard with a quick release mounting bracket. This bracket should be mounted on a suitable wall or bulkhead in a position where it can easily be retrieved in an emergency.

Although the E100/E100G is rugged and waterproof, Ocean Signal recommends mounting the EPIRB in a protected position whenever possible.

 **Do not mount the EPIRB closer than 1 metre to any steering compass as this may affect the accuracy of the compass.**

 **Keep the EPIRB away from any strong magnetic sources such as loudspeakers, compass compensation magnets, etc.**

Mark the location of the four screw holes onto the mounting position. Pre-drill the holes if required then screw the mounting bracket to the surface using the four No6 x 5/8" screws supplied.

3.3.1 Loading the EPIRB

Align the back of the lanyard storage area, situated at the rear of the EPIRB with the clip mechanism of the cradle and push into place. There will be an audible "click" indicating that the EPIRB is now secured in place.

 **Do not attach the lanyard to any part of the vessel superstructure or other part that will hinder the release of the EPIRB.**

 **Do not locate your mounting bracket in a position that would expose the EPIRB to the risk of being knocked off by passing crew bumping into it, especially in heavy weather (e.g. the companionway).**

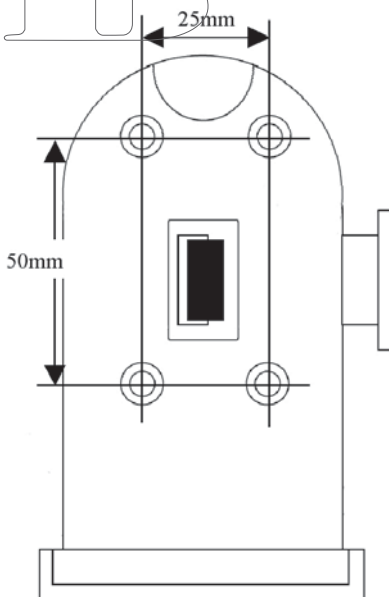

4 OPERATION

WARNING: USE ONLY IN SITUATIONS OF GRAVE AND IMMINENT DANGER MISUSE MAY RESULT IN A SEVERE PENALTY

The EPIRB is designed for best operation while floating in water. If used in other situations ensure that the EPIRB is placed in the open, clear of any cover and kept upright. Do not place the EPIRB close to large structures or under cover.

In the case of abandoning ship, if possible, recover the EPIRB and tie to the survival craft or person using the lanyard. For optimum operation, it is recommended that the EPIRB be tied to the raft with the lanyard and floated in the sea.

4.1 Manual Activation

4.1.1 Deployment From an Enclosure

1. Push in and then rotate the housing release knob anti-clockwise to release the housing cover.

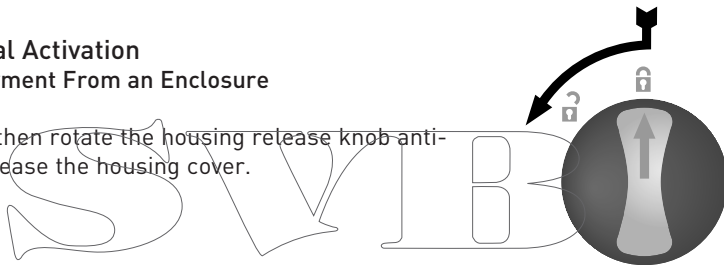

2. To remove the housing cover, tilt it, slide it sideways to free the cover from the base clips and lift off.

3. Lift the hydrostatic release mechanism and remove the EPIRB.

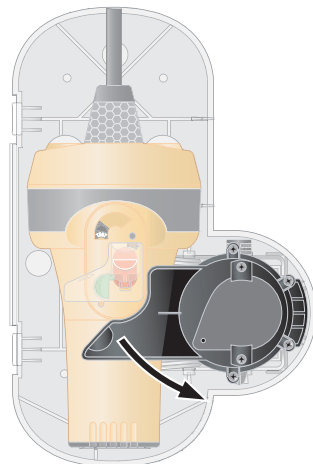
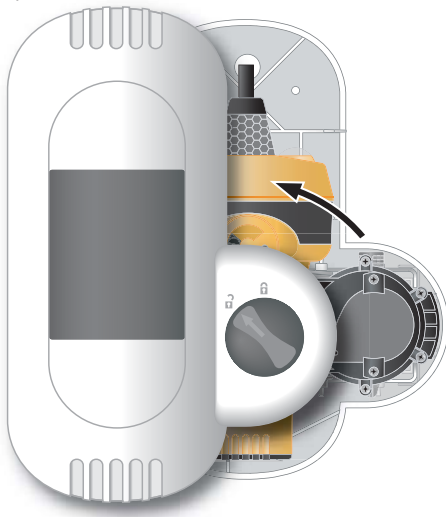

4.1.2 Deployment From a Bracket

Press the Grey release key on the right hand side of the bracket and remove EPIRB.

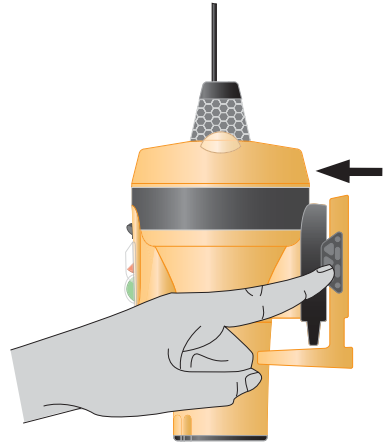

4.1.3 Manual Activation

Break off the clear protective cover over the Green and Red switches.

Holding the Green switch to the left, push the Red switch down and hold.

While holding the Red switch down, release the Green switch to lock the Red switch in the active position.

The EPIRB will now be operational. The strobe lights will begin to flash at a rate of once every 2.5 seconds as soon as the unit is activated.

For best performance it is important that the EPIRB is in an upright position with a clear view of the sky and as far away from any metallic structures as is possible.

If the EPIRB contains a GPS receiver, ensure that the GPS antenna is not obstructed and has a complete, unobstructed view of the sky – as indicated on the top of the EPIRB.

A lanyard is provided to tether the EPIRB to the lifeboat or life raft to ensure that it does not drift away. Make sure this is firmly attached.

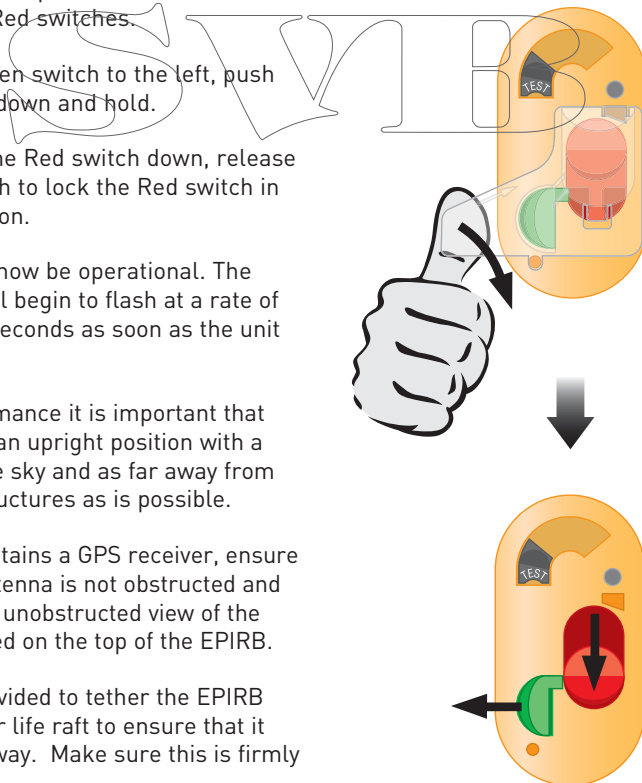

EPIRB Mode 2 seconds	Green Indicator	Red Indicator
Initial EPIRB activation	On for 1 second	
Acquiring GPS position *	1 Flash every 5 seconds	
GPS position acquired *	Flash for 1 second	
121.5MHz Tx **		1 flash, with strobe light, every 2.5 seconds
406MHz Tx		Flash for 2 seconds
406MHz Tx, with GPS position *	Flash for 2 seconds	
406MHz Tx, without valid GPS position*		Flash for 2 seconds

* SafeSea E100G only

** The 121.5MHz homer does not begin transmission until after the first 406MHz transmission - approximately 50 seconds.

4.2 Automatic Operation

The EPIRB will sense when it has been placed in water and automatically begin to operate, after a short delay, in the same manner as described above.

Note: If the EPIRB is mounted in the float free housing or on the bracket this function is disabled until the EPIRB has been removed from either fixture.

If the EPIRB is mounted in a float free housing, in the event that the vessel sinks the EPIRB will automatically be ejected from the housing allowing it to float to the surface and begin transmission.

4.3 Deactivation

4.3.1 Deactivation if Manually Activated

If the EPIRB has been inadvertently activated or the emergency situation has passed, it can be turned off simply by reversing the activation process.

Slide the Green switch to the left - the Red switch will return to the off position. Release the Green switch.

It is not possible for the user to replace the clear protective cover. Return the EPIRB to an Ocean Signal authorised service centre for replacement.

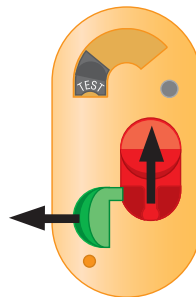

4.3.2 Deactivation if Automatically Activated

If the EPIRB was automatically activated, by placing in water, remove from the water and dry. The EPIRB will automatically switch off after approximately 30 seconds.

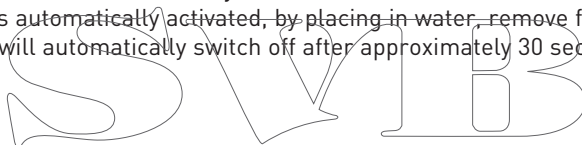

5 FALSE ALERTS

False alerts are a serious problem - they cause valuable resources to be diverted away from real emergency situations. If a false alert is initiated, by any means, it is important to contact the nearest search and rescue authority and inform them of the false alert.

Report the following information:

1. **EPIRB UIN.**
2. **Date, time and duration.**
3. **Cause of activation.**
4. **Location when the alert was activated.**
5. **Location at time of deactivation.**

If the EPIRB was activated by mistake then turn it off. The first emergency transmission will not occur for approximately 50 seconds, if the unit is turned off within this time then EPIRB will not have sent an emergency distress.

If the unit has been dropped into the water then remove from the water and dry the case, wait approximately 30 seconds for the water contacts to de-activate. If the unit is still flashing after this period, check that the unit has not been manually activated; if so then follow the procedure to manually switch the EPIRB off. The EPIRB should now be switched off, replace the EPIRB on to the cradle or into the float free housing.

The SafeSea E100/E100G is fitted with water activation contacts. Although the mounting bracket and float free housing are designed to prevent accidental activation due to heavy sea or weather conditions, if the EPIRB is not correctly fitted in it's mounting it is possible that this may cause a false alert situation.

5.1 Disabling the EPIRB

In the unlikely event that your EPIRB develops a fault and does not switch off then completely disable the unit by removing the battery, as described in section 6.3.

6 MAINTENANCE

- 6.1 Testing
- 6.1.1 Self Test Mode

WARNING: TEST TRANSMISSIONS ON THE HOMER FREQUENCY OF 121.5MHZ ARE LIMITED BY INTERNATIONAL RADIO REGULATIONS TO WITHIN THE FIRST FIVE MINUTES OF AN HOUR

It is recommended that the EPIRB is tested no more than once a month.

Activate Test Mode by rotating the grey test switch clockwise and holding for 1 second, until the LED indicator begins to rapidly flash Green, then release the test switch.

This will initiate a self test - be prepared to monitor the number of LED indicator flashes upon completion of the test.

The self test monitors the 121.5MHz homer RF power, initiates a satellite transmission in order to measure key performance parameters, will monitor the 406MHz RF power, synthesiser lock and battery voltage under load. The self test message is designed to prevent the satellite forwarding an alert message during self test. After the satellite transmission the strobe light is flashed, demonstrating operation.

A successful test is determined by a series of Green LED flashes – between one and six flashes, this sequence is repeated after a 2 second delay. A failure is determined by a series of Red LED flashes – between one and five flashes, this sequence is repeated after a 2 second delay.

The Green LED shows how many hours of use the EPIRB has undergone on the current battery. The Red indicator shows the failure condition.

Failure to follow the correct test activation procedure may result in either no activation or the LED flashing red/green. Release the switch and retry after a short pause.

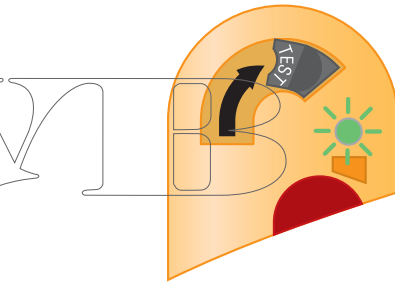

Green Indicator		Red Indicator	
No of Flashes	No of Hours Use	No of Flashes	Type of Failure
1 Flash	0 to 1hr 59min	1 Flash	121.5MHz homer
2 Flashes	2hrs to 3hrs 59min	2 Flashes	406MHz generation
3 Flashes	4hrs to 5hrs 59min	3 Flashes	406MHz power amp
4 Flashes	6hrs to 7hrs 59min	4 Flashes	Replace battery
5 Flashes	8hrs to 9hrs 59min	5 Flashes	Other failure
6 Flashes	10hrs +		

6.1.2 GPS Test Mode

WARNING : TESTING THE GPS RECEIVER IS LIMITED TO 5 TESTS OVER THE LIFETIME OF THE BATTERY. TESTING THE GPS RECEIVER EXPENDS SIGNIFICANT AMOUNTS OF BATTERY ENERGY AND MAY TAKE UP TO 10 MINUTES TO COMPLETE.

THIS TEST MUST ONLY BE PERFORMED WHERE THE EPIRB HAS A CLEAR AND UNOBSTRUCTED VIEW OF THE SKY. THIS IS REQUIRED TO ALLOW THE GPS RECEIVER TO ACQUIRE A SIGNAL FROM SUFFICIENT SATELLITES TO ALLOW IT TO DETERMINE A POSITION

It is recommended that this test is not performed in direct sunlight as it may be make counting the LED flashes at the end of the test difficult. The EPIRB must remain under observation for the whole of the test to ensure the completion of the test is not missed.

To enter the GPS self test mode, perform the following procedure:

1. Rotate the grey test switch clockwise and hold for 1 second until the indicator LED begins to rapidly flash Green.
2. Release the test switch and then quickly reactivate the test switch whilst the LED is still rapidly flashing.
3. Hold the switch until the LED begins flashing Green at a slower rate; continue to hold the test key for 5 seconds.
4. Release the switch when the LED changes from flashing Green to a constant Red.

During the test the LED will remain Red and flash Green once every 5 seconds. Successful test completion is indicated by the LED flashing Green for 10 seconds, with the strobe light flashing every 2.5 seconds. A test failure is indicated by the LED flashing Red for 10 seconds with the strobe light flashing every 2.5 seconds.

The test can be cancelled at any time by activating the Grey test switch and holding it on for 5 seconds.

The EPIRB is limited to 5 GPS self tests, the unit will not perform any more than this until the battery is replaced. If the GPS self test is initiated and the EPIRB has already performed 5 GPS self tests, the indicator will flash Red for 5 seconds and then power down. If the Grey test key is held on after the indicator has finished flashing Red, it will then begin to rapidly flash between Red and Green to indicate that the EPIRB power is being held on and is needlessly draining the battery reserves.

GPS Tests Remaining	Green LED Flashes	Strobe Flashes
4	4 (and then repeated)	2
3	3 (and then repeated)	2
2	2 (and then repeated)	2
1	1 (and then repeated)	2
0	Flashes for 5 seconds	2

6.2 Inspection

During the monthly EPIRB self test it is advised that the following inspection is performed.

1. Inspect the EPIRB for obvious signs of damage – including the state of the antenna any creases in the antenna may cause the operation of the EPIRB to be impaired.
2. Confirm that the EPIRB is securely mounted on the bracket or in the float free housing.
3. Inspect the lanyard to ensure it is not attached to any structures.
4. Confirm the battery is within the specified expiry date.
5. If the EPIRB is housed in a float free housing confirm the HRU is within the specified expiry date (Two years after the installation date).
6. Clean the EPIRB and mounting, it is recommended that the EPIRB is cleaned only using a damp cloth.



Other than the battery pack there are no user serviceable parts inside the EPIRB. **DO NOT OPEN THE EPIRB, DOING SO WILL INVALIDATE THE WARRANTY AND MAY CAUSE FALSE ALERTS**





6.3 Battery Replacement

The EPIRB is supplied with a non-hazardous 9V Lithium battery pack. It is recommended that this pack be replaced every 5 years, assuming that the EPIRB has not been used for any emergency use - if the EPIRB is operated for any purposes OTHER than the self tests, the battery should be replaced to ensure the correct operating life of the EPIRB during an emergency situation.

If the expiry date marked on the battery pack has been reached then it must be replaced to ensure correct operating life of the EPIRB during an emergency situation. Always use an Ocean Signal LB2E battery to replace the existing battery. Failure to use the correct battery may result in the EPIRB failing to perform correctly.

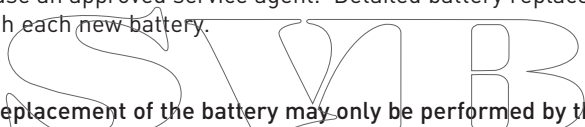
For SOLAS vessels it is recommended that the battery is replaced at the time of the Shore Based Maintenance. Batteries should only be replaced by trained personnel with access to the required test equipment to ensure correct operation after the battery exchange.

For non-SOLAS vessels, including recreational vessels, the user may replace the battery themselves, or use an approved service agent. Detailed battery replacement instructions are provided with each new battery.

- 
-  **The replacement of the battery may only be performed by the end user where it is allowed by the local or national maritime authorities.**
 -  **Dispose of exhausted batteries by returning them to your service agent. Lithium batteries require specialist methods for disposal.**
 -  **DO NOT INCINERATE!**
 -  **DO NOT DISPOSE OF AT SEA!**

6.4 HRU Replacement

If you have an EPIRB mounted in a float free housing, this will also contain a HR1E Hydrostatic Release Unit (HRU). The HRU unit must be replaced two years after installation - the expiry date is marked on the HRU and on the front of the housing. If this date has been reached then the HRU must be replaced with an Ocean Signal HR1E, failure to do so may result in the HRU not operating correctly during an emergency situation.

1. Lift the release mechanism by pulling against the spring and remove the EPIRB from the housing.

2. Push the HRU down against the spring and remove the locking pin. Carefully remove the HRU from the spring.

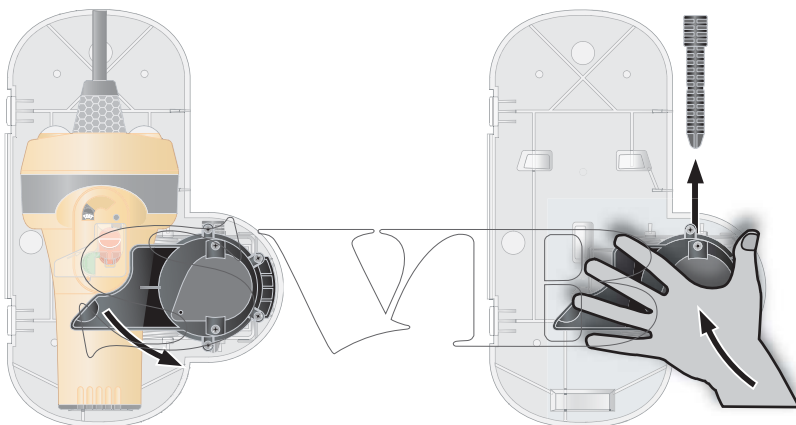

3. Using the new HRU, locate the two retaining ridges (at the bottom of the HRU) onto the spring. Carefully push the HRU against the spring.

4. Push the HRU into position as shown. Push the locking pin home with the retaining flange pointing down. Load the EPIRB into the housing.

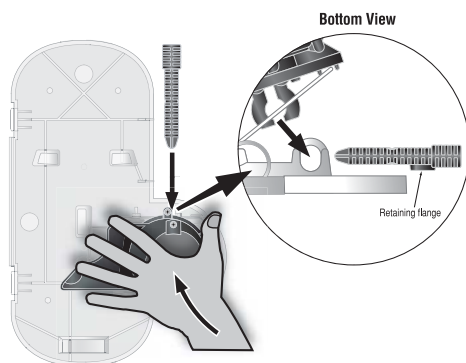
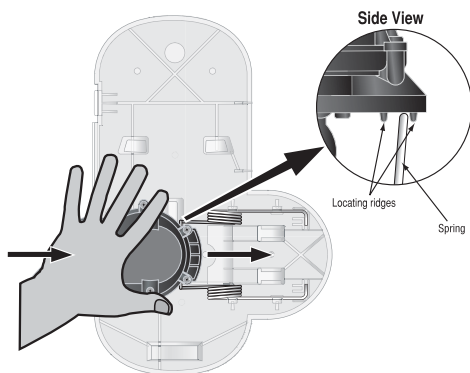

7 APPENDIX

7.1 System Overview

7.1.1 COSPAS/SARSAT System

The COSPAS/SARSAT system utilises two satellite arrays to provide distress alert and location data to search and rescue authorities.

The GEOSAR system can provide near immediate alerting within the coverage of the receiving satellite.

The LEOSAR system provides coverage of the polar region beyond the range of the GEOSAR system. It can calculate the location of distress events using Doppler processing techniques and is less susceptible to obstructions which could block a signal in a given direction.

The system is comprised of instruments on board the satellites which detect the signals from the distress beacons. Ground receiving stations, referred to as Local Users Terminals (LUTs) receive and process the satellite downlink signal to generate the distress alerts. The distress alerts, generated by the LUTs, are then received by Mission Control Centres (MCCs) which then forward the alert to Rescue Co-ordination Centres (RCCs), Search and Rescue Points of Contacts (SPOCs) and other MCCs.

7.1.2 GPS System

The GPS system is a satellite array that enables a GPS receiver to determine its position around the globe. There are a minimum of 24 satellites orbiting the Earth providing accurate position, velocity and time information.

The SafeSea E100G has a built in 50 channel GPS receiver and antenna allowing reception of this positional data. The received position is then coded into the EPIRB emergency transmission thus enabling search and rescue teams to narrow the search area and increase the effectiveness of the rescue operation.

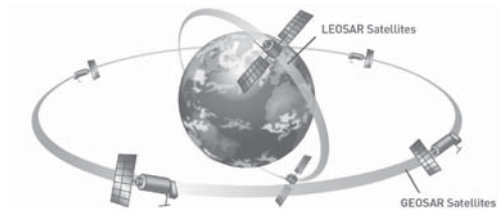

GEOSAR – Geostationary Earth Orbit
LEOSAR – Low-altitude Earth Orbit

7.2 Specifications

406Mhz Transmitter

Frequency	406.037 MHz \pm 1KHz
Output Power	5W Typical
Modulation	Phase \pm 1.1 Radians Pk (16K0G1D)
Encoding	Biphase L
Duration	520mS
Frequency Stability	2 parts per billion / 100mS
Rate	400 bps

121.5MHz Transmitter

Frequency	121.5 MHz
Output Power	25-100mW PEP
Modulation	Swept Tone AM (3K20A3X)
Sweep Range / Rate	375-1125 Hz
Modulation Depth	96%
Frequency Stability	\pm 50ppm
Duty Cycle	40%

Low Duty Cycle Strobe

Light Type	Two High Intensity LEDs
Light Colour	White
Output Power	0.75 dc effective candela
Flash Rate	20-30 per minute

Battery

Type	Lithium Manganese Dioxide (LiMnO ₂)
Operating	Typically 96Hours
Replacement Interval	5 years

GPS Receiver (Safesea E100G only)

Satellites Tracked	50 Channel Engine
Sensitivity	-146dBm
Cold Start Re-acquisition	-162dBm
Centre Frequency	1.57524 GHz
GPS Antenna	Microstrip Patch

General

Height of Body	212mm
Maximum Body diameter	110mm
Weight	735grams

Environmental

IEC60945 Category	Portable
Operating Temperature	Class 2 -20C to +55C
Storage Temperature	Class 2 -30C to +70C
Automatic release depth	4 metres maximum
Waterproof	Exceeds 10m at 20°C

7.3 Accessories

Replacement Lithium Battery for E100/E100G LB2E

7.4 Approvals

Cospas-SarsatT.001/T.007

EuropeMarine Equipment Directive MED A.1/5.6
IEC 61097-2
IEC 60945

USAUSCG/FCC Approved
FCC ID: XYEE100

WorldwideIEC 61097-2

IMO RegulationsA.662(16)

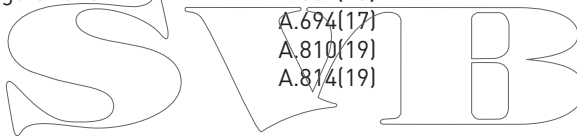

7.5 Service & Warranty

All servicing or repairs of this EPIRB must be carried out by an approved service agent.

Please retain the original packaging for your EPIRB. If the EPIRB has to be returned, for any reason, the original packaging should be used.

The battery packs used with this EPIRB are classed as non-hazardous under IATA Hazardous Transport Regulation.

- Batteries should be shipped as category 3090, packing instruction 968: part 2.
- EPIRBs with batteries should be shipped as category 3091, packing instruction 969: part 2. (The battery should be removed from the EPIRB before packing, but can be in the same box.)

Your SafeSea E100/E100G EPIRB is warranted against manufacturing defects in materials and workmanship for a period of two years from date of purchase. Ocean Signal Ltd will, at its discretion, repair or replace a faulty product free of charge, including return carriage costs to the owner.

For further assistance, please contact our Technical Service Department:

Email: service@oceansignal.com

Accidental damage and misuse or non-approved modifications are not covered by this warranty. This warranty does not affect your statutory rights.

Dealer Stamp:



Date of Purchase:

7.6 Record of Programming Details

It is recommended that the information entered on the Programming Details label on the EPIRB is also copied here for future reference.

UIN:
VESSEL NAME:
MMSI:	S V M B
COUNTRY:
CALL SIGN:

Ocean Signal Ltd.
Unit 4, Ocivan Way
Margate
CT9 4NN
United Kingdom

info@oceansignal.com
www.oceansignal.com

SVIB

