



FELL Technology AS
 Designs, manuals and features subject
 to change. For more information visit our
 website: www.fellmarine.com

MOB+

WIRELESS MAN OVERBOARD SYSTEM

REV200-1217

Thank you for choosing MOB+!

If this is the first time you use the MOB+, visit
www.fellmarine.com/explore

To see install videos, demos, FAQs, online user manual
 and other support material, visit:
www.fellmarine.com/support

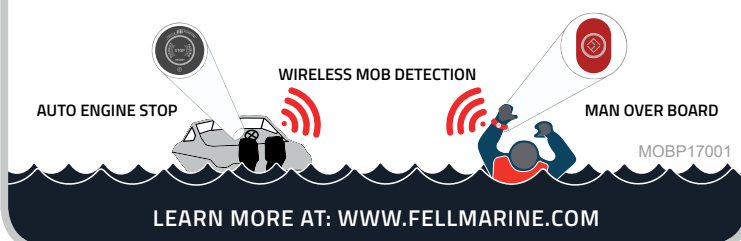

⚠ WARNING

Disconnect battery cables at battery before attempting to install this product

Read all instructions carefully before use of this product.

FELL Marine equipment and accessories are designed to the best industry standards for use in the recreational marine environment. Their design and manufacture conforms to the appropriate Electromagnetic Compatibility (EMC) regulations, but correct installation is required to ensure that performance is not compromised. Please see section EMC Installation Guidelines in the User Manual for optimum EMC conditions.

⚠ CAUTION

Within the wireless range MOB+ will not shut down the engine automatically e.g. if you fall in your boat within the wireless range the engine will not stop automatically. In this event, you can shut down the engine by pressing the button on your MOB+ xFOB or on the MOB+ xHUB. Always check your wireless range before use.

⚠ IMPORTANT INFORMATION ⚠

The xFOB is waterproof down to 10 ft./3m and can be reused after MOB event. After an MOB-event, the engine can easily be restarted by;

- dStart - 6 seconds after a MOB Event the system lets passenger restart the engine to pick up the missing person in the water. The engine can be started without reconnecting the xFOB. No interaction with xHUB necessary.
- Reconnect with the xFOB by clicking once on the xFOB to deactivate dStart and once more to connect.

EMC GUIDELINES



The guidelines given here describe the conditions for optimum EMC performance, but it is recognized that it may not be possible to meet all of these conditions in all situations. To ensure the best possible conditions for EMC performance within the constraints imposed by any location, always ensure the maximum separation possible between different items of electrical equipment. For optimum EMC performance, it is recommended that wherever possible:

FELL equipment and the cables connected to it are:

- At least 3 ft. (1 m) from any equipment transmitting or cables carrying radio signals e.g. VHF radios, cables and antennas. In the case of SSB radios, the distance should be increased to 7 ft. (2 m).
- More than 7 ft. (2 m) from the path of a radar beam. A radar beam can normally be assumed to spread 20 degrees above and below the radiating element.
- If possible the product is supplied from a separate battery from that used for engine start. Power supply voltages below the minimum specified 7V power source, and starter motor transients, can cause the product to reset. This will not damage the product, but may cause inability to start the engine.
- FELL specified cables are used. Cutting and rejoining these cables can compromise EMC performance and must be avoided unless doing so is detailed in the installation manual.

MAN OVER BOARD

MOBP17003

MOB Mode (Man Overboard Mode) is the safety mode of the system. MOB+ will automatically activate shut down of the engine when the STOP FOB is submersed in 4 inches (10 cm) of water or travels out of range from the xHUB. After 6 seconds, the system automatically activates Override Mode. In Override Mode any passenger or crew on board can restart the engine without the need to interact with the MOB+ system. This allows for a quick recovery of the missing person in the water and enhances safety.

ALARM FUNCTION: If any of the ALARM FOBs falls overboard the xHUB will **NOT stop the engine(s)**, but sound the MOB Alarm, flashing on the xFOB Connection Indicator on the xHUB and blink red in the light circle. The alarm continues until the STOP button on the xHUB is pushed to disengage the alarm.

MOB EVENT RECONNECT: In an MOB event where the STOP FOB falls overboard, the person returning from the water can reconnect the xFOB by one click to disable MOB Mode, followed by one more click on the xFOB to reconnect. Alternatively, remaining passengers with an ALARM FOB can choose to connect one of their xFOBs.

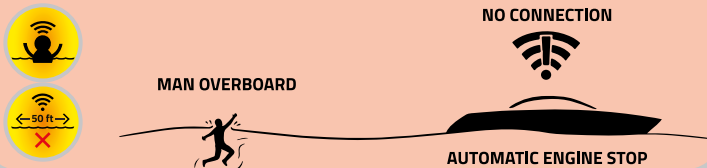

OVERRIDE MODE

MOBP17004

In the event that you forget your xFOB or if it's out of battery - don't worry. You can easily override MOB+ by holding the button on the xHUB for 10 seconds. The xHUB will give a sound signal and a yellow light signal every 30 seconds to indicate Override Mode is activated so you can start the engine(s).



dStart™

MOBP17005

dStart is the direct restart feature in the MOB+ system. 6 seconds after an MOB event with a STOP FOB, the MOB+ automatically activates Override Mode to allow any remaining passengers in the boat to restart the engine(s) directly, without interacting with the system. The Override Mode flashes yellow and gives a sound feedback every 30 seconds.



TIME-OUT FUNCTIONS



Connected: 20h Time-Out: The normal xFOB to xHUB connection will automatically time-out after 20h. This is to prevent unnecessary battery drainage of the xFOB battery. Click xFOB again to reconnect.

Override Mode: 8h Time-Out: Override Mode automatically times out after 8h to prevent engine start if the boat is left unobserved.

MOB Mode: 2h Time-Out: MOB Mode automatically times out after 2h. This is to prevent engine start if the boat is left unobserved after leaving the boat without disconnecting the xFOB.

MOBP17006

MAN OVER BOARD SEQUENCE

dStart™

Makes it possible for passengers to start the engine 6 seconds after a MOB incident to quickly rescue the person in the water

Drive

Range up to 50 feet. 4D antenna diversity ensures a robust connection.

MOB

Should you fall over board the engine will stop as you hit the water

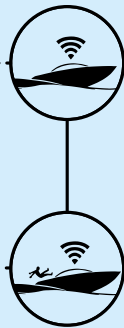

MOBP17007

TECHNICAL SPECIFICATIONS - xFOB™

MOBP17008

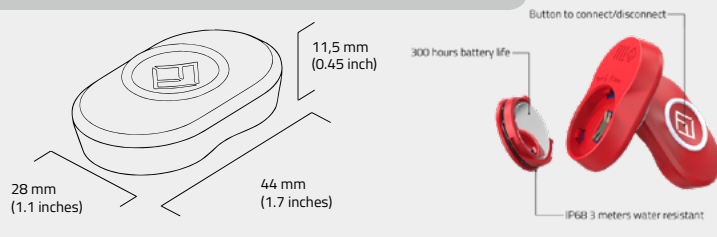

Measurements and performance

Weight	10g / 0.35oz.
Housing material	ASA / TPU / POM
Temperature range	From -15°C / 5°F to 55°C / 131°F
Voltage Source	Coin Cell Battery - 3V nominal
Power consumption	0.3 µA in sleep (0.00033 W) 30 mA in active mode (0.098W)
Battery life	300 hours continuous usage

Wireless performance

Frequency area	EU: 868 MHz	US: 915 MHz
RF signal (in)	10 dBm max.	
RF signal (out)	10 dBm max.	
4D Antenna diversity	☑	

Battery xFOB

Battery type	CR2032
Battery voltage	3V lithium battery

Certifications and compliance

Radio - xFOB	EU: R&TTE, EN 300 328, Maritime/CE	US: FCC Part 15C
EMC - xFOB	EU: EN 301 489-01 (V1.9.2), Class A	US: CISPR 16-1
Flammability - xFOB	IEC 60950 1&22, CE-UL94	
Immersion xFOB	IEC 60945, IP68, Maritime/CE - 3m / 10ft. water resistant	
RoHS (2002/95/EC) compliant materials	☑	
ABYC A-33 compliant	☑	

FAQs

- How can I override the system if the system fails or if I have lost the xFOB?**
 - If the system fails use the End Cap Connector attached to the main xHUB cable to mechanically override the system.
 - If you have lost your xFOB press and hold the button on the xHUB for 10 seconds to put the system in Override Mode.
- I already have an existing kill switch. Can I install MOB+?**
 - Yes. MOB+ is installed using wires from your existing kill switch. Please see installation guide for instructions
- I have a boat made from metal. Can I install MOB+?**
 - Actual signal reduction, if any, will vary from boat to boat. Should the signal be noticeably worse, we recommend using an external antenna to put on the top side of the helm, supplied from FELL Marine.
- Can passengers start the boat if I were to fall over board?**
 - Yes, this is one of the main features of MOB+. 6 seconds after a MOB Event the system lets passenger restart the engine to pick up the missing person in the water.

TECHNICAL SPECIFICATIONS -xHUB™

MOBP17009

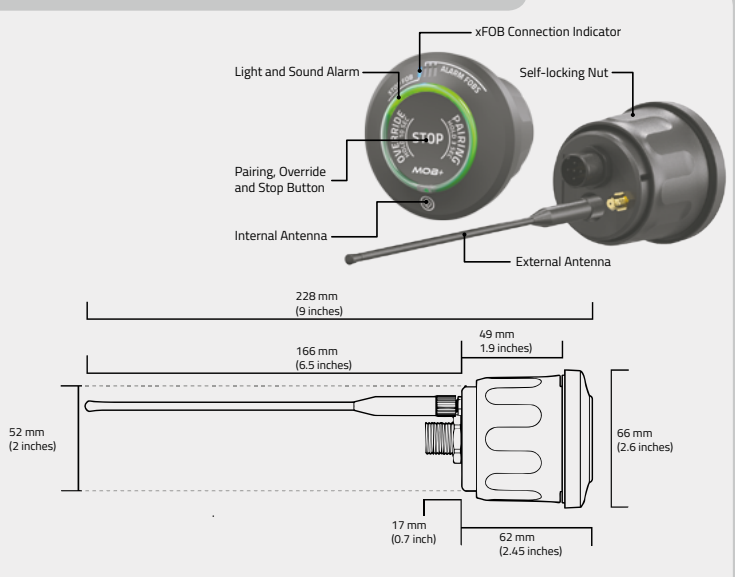

Measurements and performance

Weight	164g / 5.8oz.
Housing material	ASA / TPU / PBT / POM - RoHS
Temperature range	From -15°C / 5°F to 55°C / 131°F
Voltage Source	10-32Vdc
Power consumption	Active Mode: 180mA (2.5W max. at 13.8Vdc), Standby: <30mA, <0.4W max. at 13.8V
Fuse	1A-3A
Alarm decibel level	>85db
Kill Switch Relay Max Current Tolerance	5A continuously

Wireless performance

Frequency area	EU: 868 MHz	US: 915 MHz
RF signal (in)	10 dBm max.	
RF signal (out)	10 dBm max.	
4D Antenna diversity	☑	

Certifications and compliance

Radio - xHUB	EU: R&TTE, EN 300 328, Maritime/CE	US: FCC Part 15C
EMC - xHUB	EU: EN 301 489-01 (V1.9.2), Class A	US: CISPR 16-1
Flammability - xFOB	IEC 60950 1&22, CE-UL94	
Immersion xFOB	IEC 60945, IP68, Maritime/CE - 3m / 10ft. water resistant	
RoHS (2002/95/EC) compliant materials	☑	
ABYC A-33 compliant	☑	

INSTALLATION

MOBP17010

1

The installation is simple and below you will find a quick guide. See next page for wiring instructions.

For more information, visit our website www.fellmarine.com/support

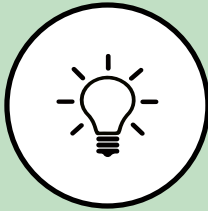

YOUR ENGINE

Visit: www.fellmarine.com/support to find wire diagram for your engine.

Place the xHUB with the antenna at least ~ 10" / 30cm from other electronics equipment transmitting EMI. The antenna should be in as free space as possible, but where necessary it can be bent up to 45 degrees.

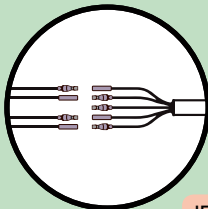
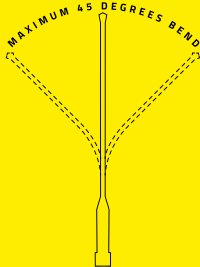

YOUR ENGINE

Connect the signal wires to the existing kill switch wires and the power wires to power.

IF YOU HAVE MULTIPLE ENGINES: SEE BELOW



2-1/16" / 52MM HOLE

Drill a 2-1/16" / 52mm hole in a suitable place adjacent to the drivers position.

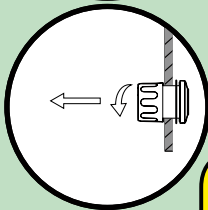

MOUNT xHUB

Insert the xHUB to the pre-drilled hole and tighten the nut.

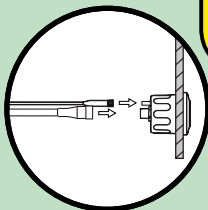
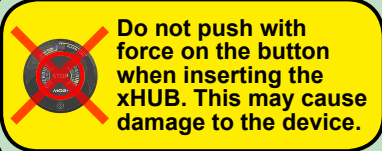

CABLE & ANTENNA

Connect the cables and the antenna to the xHUB.

IMPORTANT

We recommend that the installation of the MOB+ in your boat is performed by skilled personnel familiar with electric wiring, or by a professional mechanic or electrician. This is to prevent any malfunction of the device related to installation.

xFOB INITIAL PAIRING

MOBP17011

2

After proper installation, pair the xFOB and the xHUB as described below. The xHUB remembers the 20 last paired xFOBs. Pairing saves the ID of xFOBs in the memory of the xHUB. Pairing is only done the first time you use an xFOB with an xHUB. Remember, four xFOBs can be connected at the same time. One as a STOP FOB, three as ALARM FOBs.

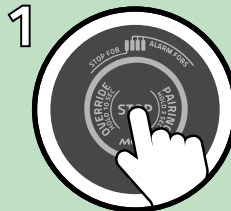

HOLD 3 SEC

Pairing is only necessary the first time you use your MOB+. Press and hold the button on your xHUB.



BLUE LIGHT

Release the button when the xHUB starts flashing blue and gives a sound signal indicating Pairing Mode.



HOLD 3 SEC

Immediately after releasing the button on the xHUB, press and hold the button on your xFOB.

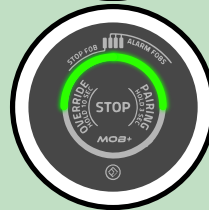

GREEN LIGHT

The xHUB will give a sound signal and a green light to indicate a successful pairing.



INSTALLING MOB+ IN A METAL BOAT

If your helm is made out of conducting materials the wireless signals from MOB+ may be degraded. The amount of signal degradation experienced may vary from across boats and must be tested for each case. If the signal is very poor you can install a separate external antenna outside of your helm to increase the signal strength. Go to www.fellmarine.com for more information.

DRILLING THE HOLE

The xHUB measures: Ø=51,5mm / 2.03 in
Drill a 52mm / 2-1/16" hole

Be sure not to drill through any existing cables or equipment mounted or situated on the backside of your intended xHUB position!

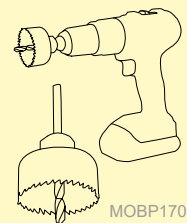

MOBP17013

xFOB BATTERY

MOBP17014

Battery Life: 300h Active Use

xHUB will indicate low battery on the xFOB by blinking the light bar respective to the connected xFOB. Change the battery within 15 hours when the light bar blinks. FELL recommends using Panasonic or Sony CR2032 coin cell batteries.



VERIFY INSTALLATION

MOBP17012

3 After installation, test the system as described below to ensure installation is done correctly. Always make sure the system is working properly before operating your vessel.



CONNECT

Click the button on your xFOB to connect.



The xHUB will give a sound signal and a GREEN light to indicate a successful connection.



START ENGINE

Start your engine.

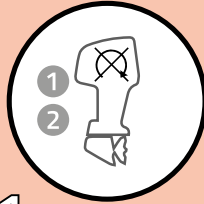

TEST THE MOB+

Test the MOB+ by disconnecting with the xFOB or by submerging the xFOB.

Both described methods are equal in terms of testing stop functionality.



DISCONNECT

Click the xFOB to stop the engine
-The system will now shut down the engine and disconnect the wireless system.

RECONNECT AND RESTART THE ENGINE BEFORE TESTING SUBMERSION

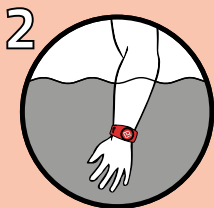

SUBMERSION

Submerge the xFOB in the sea or the ocean more than 4 inches.

-The system will now go into Man Over Board mode and shut down the engine. After 6 seconds the xHUB will go into override mode. Press the xHUB or xFOB to disconnect the wireless system.

MOBP17015

A bucket of water is not sufficient to test the functionality of MOB+. Test the system in the sea or ocean/lake.

SUPPORT

MOBP17026



WATCH VIDEOS!

On www.fellmarine.com/videos you will find installation and user guide videos.



WE ARE HERE TO HELP YOU

Customer care: www.fellmarine.com/customer-care
Business hours: Monday-Friday 08:00am – 04:00 pm
Email: support@fellmarine.com
Web support: <https://www.fellmarine.com/support/>
Social Media: facebook.com/fellmarine
Web: <https://www.fellmarine.com>

CONNECTION OF xFOBS

MOBP17027

4 The MOB+ allows for the pilot to be connected with his xFOB as a STOP FOB and three more crew members or passengers to be connected as ALARM FOBs. All xFOBs are universal and can either be STOP FOB or ALARM FOB. The first connected xFOB on each boat trip will be assigned as the "Master" and become the STOP FOB. Successive connections automatically become ALARM FOBs.



CONNECT

Click the button on your xFOB to connect.



STOP FOB

When connecting the first xFOB it becomes the STOP FOB. The STOP FOB will automatically shut down the engine(s) if the pilot falls overboard and disconnect the ALARM FOBs.

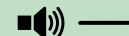

ALARM FOBs

When connecting the second, third and fourth xFOBs they become ALARM FOBs.

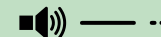

If any of the ALARM FOBs falls overboard the xHUB will sound the MOB Alarm, flashing on the xFOB indication bar and flashing red on the light circle. The alarm continues until the STOP button on the xHUB is pushed to disengage the alarm.



In an MOB event where the STOP FOB falls overboard, remaining passengers with an ALARM FOB can choose to reconnect one of their xFOBs first to become the new STOP FOB, successive connections will become ALARM FOBs as normal.



DISCONNECT

Click the button on your xFOB to disconnect.

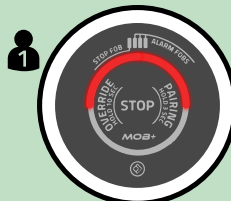

STOP FOB

Disconnecting the STOP FOB will disconnect all FOBs regardless of their connected state and shut down the engine(s).

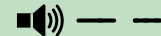

ALARM FOBs

Disconnect an ALARM FOB individually by clicking on the ALARM FOB.



CONNECTING MULTIPLE FOBS WITH STOP FUNCTION

5

How to connect any of the ALARM FOBS with STOP function. In the event that one (or more) of the ALARM FOBS with STOP function goes overboard, it will trigger automatic engine shut down.

⚠ Manual button press on an ALARM FOB connected with STOP function (disconnect) will shut down the engine(s).

STOP FOB OVERBOARD



⚠ If the STOP FOB or any of the connected ALARM FOBS with STOP function goes overboard, the xHUB will shut down the engine(s), disconnect all connected FOBS and go into MOB mode. Anyone left on board can restart the engine as normal after 6 seconds without having to reconnect any FOBS or interact with the MOB+ system.

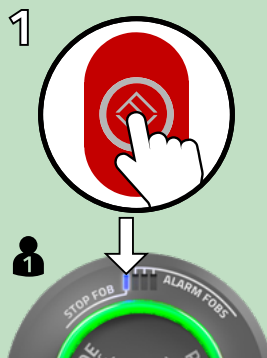

CONNECT THE FIRST FOB

Click the button on your xFOB to connect.

STOP FOB CONNECTED

When connecting the first xFOB it becomes the STOP FOB. The STOP FOB will automatically shut down the engine(s) if the pilot falls overboard and disconnect the all FOBS.

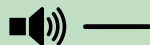

NOTE: Any combination of ALARM FOBS with or without STOP function can be connected. E.g. Connect a new ALARM FOB with only ALARM functionality by one click on the ALARM FOB, going directly to step 2.2. without first performing step 2.1. above, after a previous ALARM FOB with STOP function has been connected.

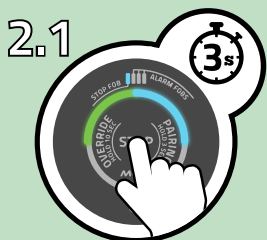

ACTIVATE STOP FUNCTION FOR THE NEXT CONNECTING ALARM FOB

Press and hold the button on the xHUB for 3 seconds to activate STOP function on the next connecting ALARM FOB. The xHUB lights shifts between green and blue.



CONNECT ALARM FOB WITH STOP FUNCTION

Immediately after releasing the button on the xHUB, click the button on the next xFOB to be connected as ALARM FOB with STOP function.

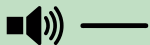

Repeat step 2.1 and 2.2 to connect successive ALARM FOBS with STOP function



DISCONNECT

Click the button on your xFOB to disconnect.



DISCONNECTING STOP FOB OR ALARM FOB WITH STOP FUNCTION

Disconnecting the STOP FOB or ALARM FOB with STOP function will shut down the engine(s) and disconnect all FOBS regardless of their connected state.

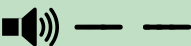

CONNECTING KILL SWITCH SIGNAL WIRES

MOBP17016

MOB+ xHUB has three kill switch signal wires. **Only two of the three wires should be used.** Connect the two signal wires to the existing kill switch wires in your boat. Most outboard engines have **Close to Stop (CS)** kill switch system and use **Gray and Orange** wire for connection. See wiring diagram below.

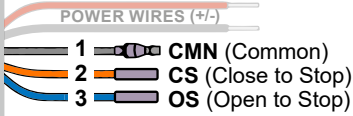

- 1 Common (CMN) - Grey Wire**
Use with Orange **or** Blue wire
- 2 Close to Stop (CS) - Orange Wire**
Use with Grey Wire
- 3 Open to Stop (OS) - Blue Wire**
Use with Grey Wire

⚠ Kill Switch Relay Max Current Tolerance: 5A continuously

! Before connecting the xHUB Signal Wires, you must verify which kill switch principle is used by your engine manufacturer. See section "CLOSE TO STOP / OPEN TO STOP" below in this manual if applicable. **After installation, verify functionality as in step 3 "Verify Installation" above.**

KEEP EXISTING OR MULTIPLE KILL SWITCH

Install the MOB+ inline with your existing kill switch or inline with multiple kill switches by connecting it in parallel (e.g. multiple helm positions with separate kill switches). The below picture shows an example with Close to Stop connection as on Mercury engines.

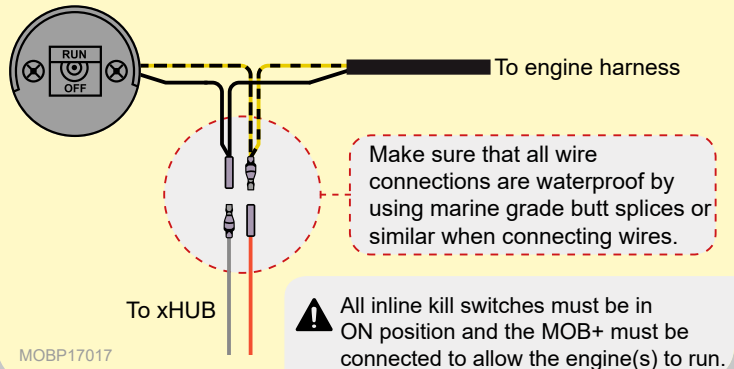

CONNECTING POWER (+/-)

MOBP17018

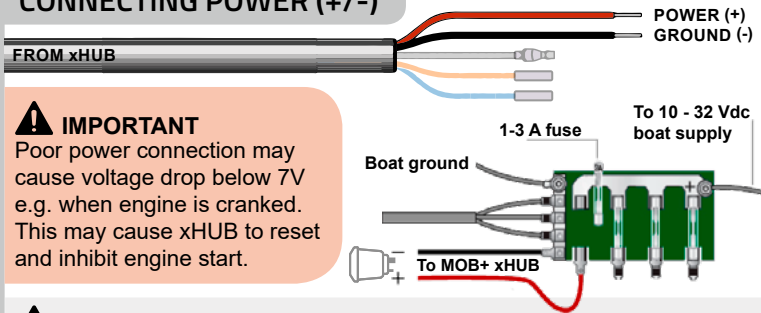

⚠ IMPORTANT
Poor power connection may cause voltage drop below 7V e.g. when engine is cranked. This may cause xHUB to reset and inhibit engine start.

⚠ RECOMMENDED
Wire the xHUB to a circuit with a power switch to avoid battery drainage. The xHUB has a power draw of 30mA in idle mode while connected to a power source.

! **Min. Voltage: 7V** - Below this voltage the unit will turn off and you will not be able to start your engine.
Max. Voltage: 32V Do not exceed this voltage because this can damage the MOB+ xHUB and void the warranty.

MECHANICAL SYSTEM OVERRIDE

MOBP17019

In the unlikely event that the MOB+ System stops functioning. Unplug the xHUB and plug the emergency cap into the cable to be able to drive your boat. The emergency cap is located on the cable supplied with the MOB+ xHUB.

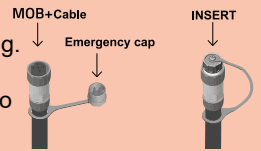

WATERPROOF CONNECTIONS

MOBP17020

Make sure that all wire connections are waterproof by using marine grade butt splices or similar when connecting wires.

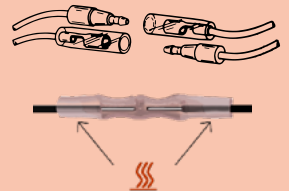

Splice Wire Dimension:
20-16 AWG / 0.5 - 1.5 mm²

CLOSE TO STOP / OPEN TO STOP

General wiring diagrams showing wiring connections for Close to Stop and Open to Stop kill switch principle.

Testing your kill switch principle

Test the kill switch principle by connecting a multimeter to both cables from the existing mechanical kill switch. Set multimeter to measure resistance and the kill switch is in the position which the engine will not run (cord is not inserted in the mechanical kill switch).

Close to 0 (zero) resistance: Close to stop (CS)

Infinite resistance measured: Open to stop (OS)

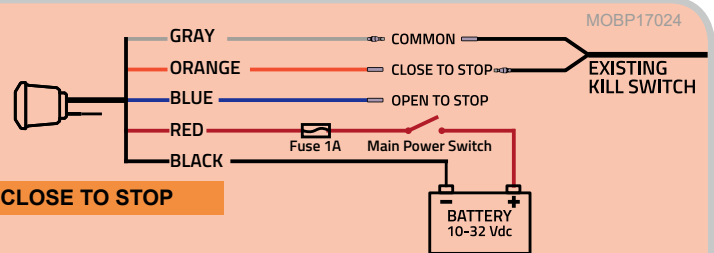
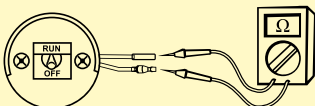

CLOSE TO STOP

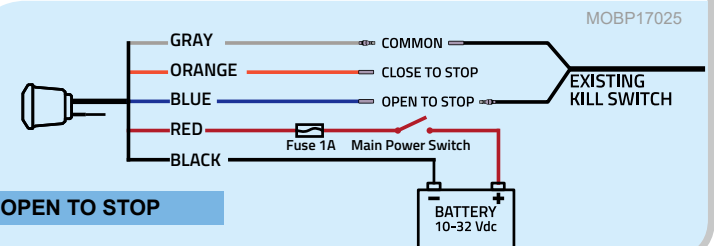

OPEN TO STOP

WIRING SECTION

MERCURY

IMPORTANT
Avoid cutting or modifying original kill switch wiring

RECOMMENDED
If keeping mechanical kill switch in place, connect MOB+ in parallel with mechanical kill switch to avoid potential danger from a non-functional mechanical kill switch.

RECOMMENDED
Make sure that all wire connections are waterproof by using marine grade butt splices or similar when connecting wires.

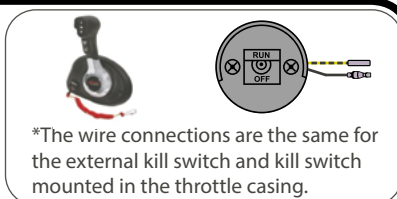
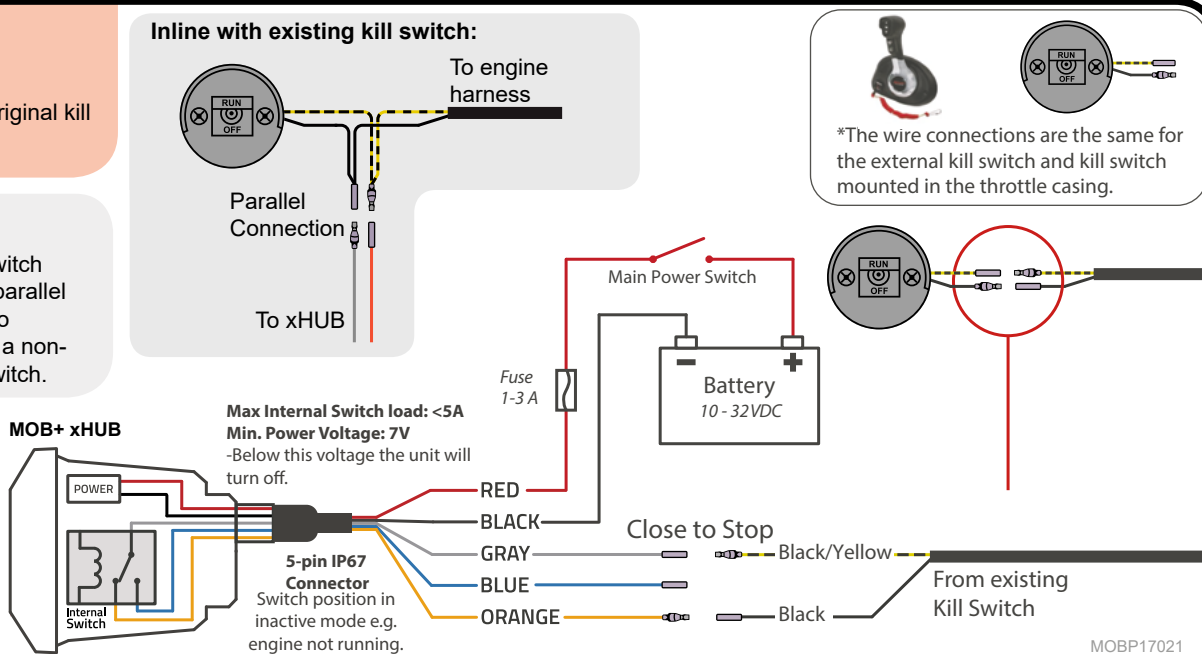

YAMAHA

IMPORTANT
Avoid cutting or modifying original kill switch wiring

RECOMMENDED
If keeping mechanical kill switch in place, connect MOB+ in parallel with mechanical kill switch to avoid potential danger from a non-functional mechanical kill switch.

RECOMMENDED
Make sure that all wire connections are waterproof by using marine grade butt splices or similar when connecting wires.

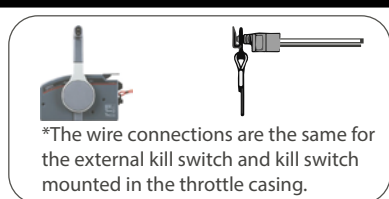
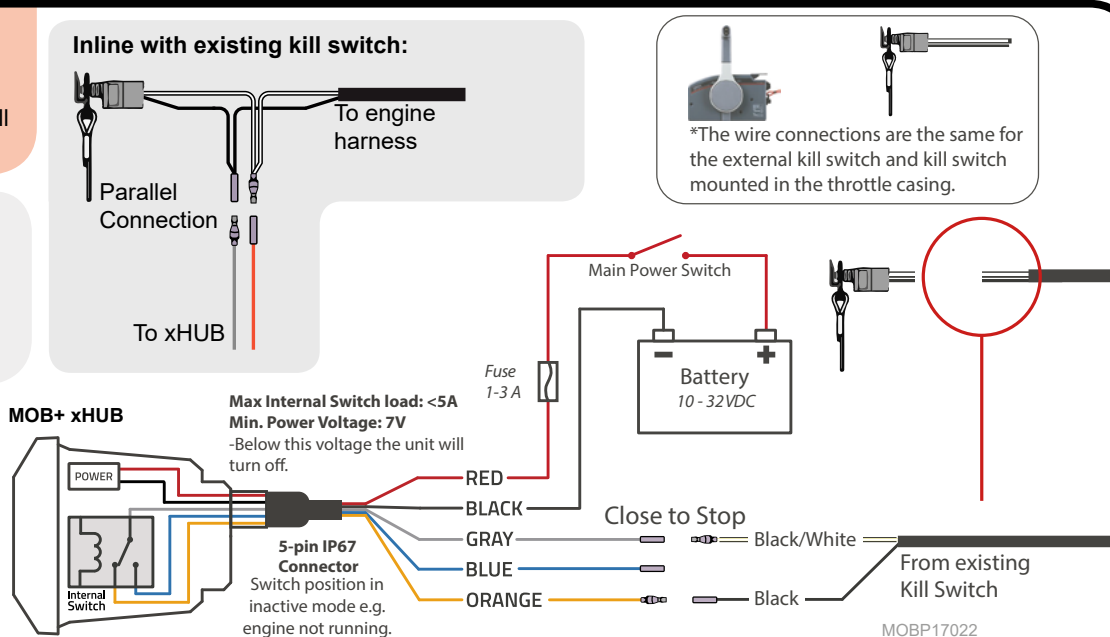

FOR OTHER ENGINE BRANDS SEE WWW.FELLMARINE.COM/SUPPORT

MOB+ MULTIPLE ENGINE HARNES (MOB+ MEH)

This product is designed to be used in conjunction with the MOB+ xHUB to stop multiple engines simultaneously for multiple outboard installations. The MOB+ xHUB should be installed prior to installation of this Multiple Engine Harness.

Part name: MOB+ Multiple Engine Harness MOBP17023
P/N: (F-A/N): 72.380.401
Availability: FELL Marine dealers and buy.fellmarine.com

IMPORTANT

- WHITE wire on MOB+ MEH is signal wire; each engines signal wire must be connected to the WHITE wire on the MOB+ MEH.
- BLACK wire on the MOB+ MEH is GND wire; each engines GND wire must be connected to the BLACK wire on the MOB+ MEH.
- Connect WHITE and BLACK wires in pairs as bundled on the MEH kit.

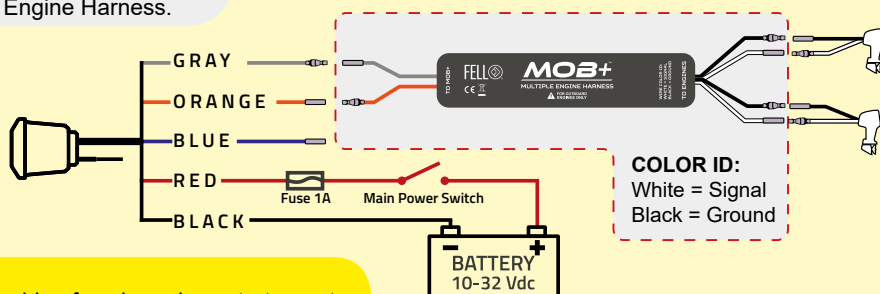

CAUTION
For multiple outboard installations, the black (-) battery cable of each engines starter motor ground circuit, MUST BE connected to each other by a common circuit (cable) capable of carrying the starting current of each engines starter motor. (i.e. A locally obtained battery cable connected between the negative (-) terminal of each outboards cranking battery.)

*Multiple Engine Harness kit includes User Manual, please read this carefully before installing this product.

Important information and caution

Read all instructions carefully before use of this product.

FELL Marine equipment and accessories are designed to the best industry standards for use in the recreational marine environment. Their design and manufacture conforms to the appropriate Electromagnetic Compatibility (EMC) regulations, but correct installation is required to ensure that performance is not compromised. Please see section EMC Installation Guidelines in the User Manual for optimum EMC conditions.

Within the wireless range MOB+ will not shut down the engine automatically e.g. if you fall in your boat within the wireless range the engine will not stop automatically. In this event, you can shut down the engine by pressing the button on your MOB+ xFOB or on the MOB+ xHUB. Always check your wireless range before use.

Make sure that the system is working properly before leaving the dock. Refer to the next page in this User Manual for instructions on how to use the system and information about normal system operations.

Always make sure to check the battery level sign on the xHUB before driving the boat. Confer with section xFOB Battery in this User Manual to check how many hours there are left of battery life on the xFOB.

Never attempt fast speed or dangerous maneuvers of the boat, especially if battery level is low on the xFOB. Battery depletion of xFOB can cause sudden engine stop and result in loss of control or maneuverability of the boat.

Never attempt any service of inside components in either the xHUB or the xFOB.



Voir www.fellmarine.com/support pour des informations importantes, consignes d'installation CEM, la garantie et exclusions en français.



Ver www.fellmarine.com/support para obtener información importante, pautas para la instalación de EMC la garantía y limitaciones de responsabilidad en Español.



Siehe www.fellmarine.com/support für wichtige Informationen, EMV-Installationsrichtlinien Gewährleistung und Haftungsausschlüsse in deutscher Sprache.

© FELL Technology AS, Nedre Storgate 46, N-3015, Drammen, Norway. FELL®, WIMEA®, WIMEA Protocol, MOB+, xHUB, xFOB, xTAG and its logos are trademarks of FELL Technology AS, its subsidiaries and affiliates. The shape and design of this product are a trademark of FELL Technology AS, subsidiaries and affiliates. NMEA®, NMEA 2000®, and the NMEA 2000 logo are registered trademarks of the National Marine Electronics Association. All other trademarks or registered trademarks are the property of their respective owners. Designed in Norway. Made in China and Taiwan. All rights reserved. Product features, appearances and specifications may be subject to change without notice. Read all instructions carefully before use. Visit www.fellmarine.com/support for complete Owner's Manual. Please retain this information for future reference.

For products sold in the US/CAN

Changes or modifications to the equipment not expressly approved by the party responsible for compliance could void the user's authority to operate the equipment.

This device complies with Part 15 of the FCC Rules. Operation is subject to the following two conditions: (1) this device may not cause harmful interference, and (2) this device must accept any interference received, including interference that may cause undesired operation.

Note: This equipment has been tested and found to comply with the limits for a Class B digital device, pursuant to part 15 of the FCC Rules. These limits are designed to provide reasonable protection against harmful interference in a residential installation. This equipment generates, uses and can radiate radio frequency energy and, if not installed and used in accordance with the instructions, may cause harmful interference to radio communications. However, there is no guarantee that interference will not occur in a particular installation. If this equipment does cause harmful interference to radio or television reception, which can be determined by turning the equipment off and on, the user is encouraged to try to correct the interference by one or more of the following measures:

—Reorient or relocate the receiving antenna.

—Increase the separation between the equipment and receiver.

—Connect the equipment into an outlet on a circuit different from that to which the receiver is connected.

—Consult the dealer or an experienced radio/TV technician for help.

MOB+ xHUB: This device complies with FCC RF radiation exposure limits set forth for an uncontrolled environment. The antenna used for this transmitter must be installed to provide a separation distance of at least 20 cm from all persons and must not be co-located or operating in conjunction with any other antenna or transmitter.

MOB+ xFOB: This device is exempted from FCC SAR testing since the RF Output Power is below the exemption limit.

California ONLY: Perchlorate Material - special handling may apply.

See: <http://www.dtsc.ca.gov/hazardouswaste/perchlorate>

Déclaration d'exposition aux radiations:

Cet équipement est conforme aux limites d'exposition aux rayonnements IC établies pour un environnement non contrôlé. Cet équipement doit être installé et utilisé avec un minimum de 20 cm de distance entre la source de rayonnement et votre corps.

Radiation Exposure Statement

This equipment complies with IC radiation exposure limits set forth for an uncontrolled environment. This equipment should be installed and operated with minimum distance 20 cm between the radiator & your body.

This device complies with Industry Canada licence-exempt RSS standard(s). Operation is subject to the following two conditions: (1) this device may not cause interference, and (2) this device must accept any interference, including interference that may cause undesired operation of the device. Le présent appareil est conforme aux CNR d'Industrie Canada applicables aux appareils radio exempts de licence. L'exploitation est autorisée aux deux conditions suivantes : (1) l'appareil ne doit pas produire de brouillage, et (2) l'utilisateur de l'appareil doit accepter tout brouillage radioélectrique subi, même si le brouillage est susceptible d'en compromettre le fonctionnement.

Disclaimer

Always boat responsibly. Before starting, know your boat and waterway rules. Always follow your boat manufacturer's procedures of operation. Never overload the boat and be sure to wear your life jacket at all times. Check your boat for all required safety equipment and never operate a boat under the influence of alcohol. Check your local weather forecast before leaving the dock and always provide a float plan to your marina, member of your family or friend.

In no event shall FELL Technology AS and its subsidiaries and/or its suppliers, agents or affiliates be liable for any direct, indirect, punitive, incidental, special consequential damages, to property or life, whatsoever arising out of or connected with the improper installation, misuse, improper maintenance, self-repair, or tampering of our products.

EMC Installation Guidelines

FELL equipment and accessories are designed to the best industry standards for use in the recreational marine environment. Their design and manufacture conforms to the appropriate Electromagnetic Compatibility (EMC) regulations, but correct installation is required to ensure that performance is not compromised.

The guidelines given here describe the conditions for optimum EMC performance, but it is recognized that it may not be possible to meet all of these conditions in all situations. To ensure the best possible conditions for EMC performance within the constraints imposed by any location, always ensure the maximum separation possible between different items of electrical equipment. For optimum EMC performance, it is recommended that wherever possible:

- FELL equipment and the cables connected to it are:
- At least 3 ft. (1 m) from any equipment transmitting or cables carrying radio signals e.g. VHF radios, cables and antennas. In the case of SSB radios, the distance should be increased to 7 ft. (2 m).
- More than 7 ft. (2 m) from the path of a radar beam. A radar beam can normally be assumed to spread 20 degrees above and below the radiating element.
- If possible the product is supplied from a separate battery from that used for engine start. Power supply voltages below the minimum specified for a product, and starter motor transients, can cause the product to reset. This will not damage the product, but may cause the loss of some information and may change the operating mode.
- FELL specified cables are used. Cutting and rejoining these cables can compromise EMC performance and must be avoided unless doing so is detailed in the installation manual.

Warranty, Important Product- and Safety Information

Failure to avoid the following potentially hazardous situations could result in an accident or collision resulting in death or serious injury.

Disclaimer

By using this device you agree upon all the following guidelines and information provided in this document. Read all instructions carefully before using this device. Always boat responsibly. Before starting, know your boat and waterway rules. Always follow your boat manufacturer's procedures of operation. Never overload the boat and be sure to wear your life jacket at all times. Check your boat for all required safety equipment and never operate a boat under the influence of alcohol. Check your local weather forecast before leaving the dock and always provide a float plan to your marina, member of your family or friend. In no event shall FELL and its subsidiaries and/or its suppliers, agents or affiliates be liable for any direct, indirect, punitive, incidental, special consequential damages, to property or life, whatsoever arising out of or connected with the improper installation, use, misuse, improper maintenance, self-repair, or tampering of our products.

Marine Operation Warnings

- You are responsible for the safe and prudent operation of your vessel. This device is a tool to enable you to enhance your safety while operating your vessel. It does not relieve you from the responsibility of safely operating your vessel. Avoid navigational hazards and never leave the helm unattended.
- Always drive the boat carefully and in accordance with local laws.
- Use this device only as a safety aid. This device does not replace the cord based kill switch, and should be used at your own discretion and responsibility, knowing that in the event that you fall in your vessel the system may not automatically shut down your engine.
- This device will shut down your engine and give an alarm signal when you are out of wireless range or falls into the water within 2 seconds. Within the wireless range this device will not shut down the engine automatically e.g. if you fall in your boat within the wireless range the engine will not stop automatically. In this event, you can shut down the engine by pressing the button on your MOB+ xFOB or on the MOB+ xHUB. Always check your wireless range before use. The wireless range in air may vary from 5 – 40 meters (15 – 120 feet) depending on the wireless environment surrounding your vessel.
- Make sure that the system is working properly before leaving the dock. Refer to the section Verify Installation in this User Manual for instructions on how to use the system and information about normal system operations.
- Always make sure to check the battery level sign on the xHUB before operating your vessel. Confer with section xFOB Battery in this User Manual to check how many hours there are left of battery life on the xFOB.
- Never attempt fast speed or dangerous maneuvers of the boat, especially if battery level is low on the xFOB. Battery depletion of xFOB can cause sudden engine stop and result in loss of control or maneuverability of the boat.
- Do not leave your xFOB in the boat unobserved, this to prevent easy theft of the boat if the ignition key is also situated in the vessel. Please refer to the engine manufacturer for information regarding ignition and starting procedure of the engine.

Other safety Considerations

Small parts contained in your device and its accessories may present a choking hazard to small children. Personal medical devices, such as pacemakers, may be sensitive to magnetic and electromagnetic fields. Since this device contains magnets and emits electromagnetic fields, they should be kept at least 30 cm from any personal medical device. If any interference is observed, consult with your physician before resuming use. Items with magnetically-stored data, such as credit cards and hard drives, may also be sensitive to magnetic or electromagnetic fields, and should not be placed near this device.

CE Declaration of Conformity

FELL equipment and accessories are designed to the best industry standards for use in the recreational marine environment. Their design and manufacture conforms to the appropriate Electromagnetic Compatibility (EMC) regulations, but correct installation is required to ensure that performance is not compromised. Please see section EMC Installation Guidelines in the User Manual for optimum EMC conditions. Products sold in the EU/EEA are in compliance with the essential requirements and other relevant provisions of R&TTE Directive 1999/5/EC.

CE SAR Compliance

For products sold in the EU/EEA this device meets the EU requirements (1999/519/EC) on the limitation of exposure of the general public to electromagnetic fields by way of health protection. The limits are part of extensive recommendations for the protection of the general public. These recommendations have been developed and checked by independent scientific organizations through regular and thorough evaluations of scientific studies. The unit of measurement for the European Council's recommended limit for mobile devices is the "Specific Absorption Rate" (SAR), and the SAR limit is 2.0 W/kg averaged over 10 gram of tissue. It meets the requirements of the International Commission on Non-Ionizing Radiation Protection (ICNIRP).

Wireless Safety and Compliance

Turn your wireless connection off in areas where wireless use is forbidden or when it may cause interference or danger. Some specific situations are described below. In general, you should not use your FELL devices with your wireless connection turned on any place you are not allowed to use a cellular device. To prevent possible interference with aircraft systems, aviation agencies require you to have permission from a crew member to use your device's wireless service. We do not recommend to use FELL devices when flying.

Battery Information

Standard battery used in this device from manufacturing is:

Panasonic – BATTERY LITHIUM COIN 3V 20MM CR2032. Lead free / RoHS compliant by exemption.

Manufacturer Part Number: CR2032L/BE.

Panasonic CR2032L/BE Specification Datasheet for battery can be found here: https://s3-eu-west-1.amazonaws.com/generalweb/productinfo/panasonic_cr2032_datasheet.pdf

Panasonic CR2032L/BE MSDS Safety Datasheet can be found here: https://s3-eu-west-1.amazonaws.com/generalweb/productinfo/panasonic_cr2032_productsafety.pdf

FELL recommend using the above battery when changing battery in MOB+ xFOB device, to ensure wireless connection quality and battery life performance.

Recycling

In some areas, the disposal of certain electronic devices is regulated. Make sure you dispose of or recycle all FELL devices in accordance with your local laws and regulations.

Other Electronic Devices

FELL devices generate, use, and radiate radio frequency (RF) energy and, if not used in accordance with its instructions, may cause interference to radio communications and electronic equipment, i.e. if hardware or software is being tampered with or the device has become broken. FELL devices are designed and manufactured to only communicate with FELL devices. External RF signals may affect improperly installed or inadequately shielded electronic operating systems, entertainment systems, and personal medical devices. While most modern electronic equipment is shielded from external RF signals, if in doubt, check with the manufacturer or contact FELL for support. For personal medical devices (such as pacemakers and hearing aids), consult with your physician or the manufacturer to determine if they are adequately shielded from external RF signals, showing this user guide to the respective physician or manufacturer. In the unlikely event that you experience interference with other electronic devices, please contact customer support on: www.fellmarine.com/support or contact the manufacturer of the respective electronic device. There are some places where RF signals could constitute a hazard, such as health care facilities, and construction sites. If you are not sure, look around for signs indicating that two-way radios or cell phones should be turned off.

Patent notice

The FELL devices and/or methods used in association with the FELL devices may be covered by one or more patents or pending patent applications.

FELL is a proud member of the following leading marine industry organizations:



Wireless System Powered By:



Limited Warranty

This FELL product is warranted to be free from defects in materials or workmanship for two years from the date of purchase. Within this period, FELL will, at its sole option, repair or replace any components that fail in normal use. Such repairs or replacements will be made at no charge to the customer for parts or labor, provided that the customer shall be responsible for any transportation cost. This warranty does not apply to: (i) cosmetic change, such as scratches, nicks and dents; (ii) consumable parts, such as batteries, unless product damage has occurred due to the defect in materials or workmanship; (iii) damage caused by accident, abuse, misuse, water, flood, fire, or other acts of nature or external causes; (iv) damage caused by service performed by anyone who is not an authorized service provider of FELL, or (v) damage to a product that has been modified or altered without the written permission of FELL, or (vi) damage to a product that has been connected to power and/or data cables that are not supplied by FELL. In addition, FELL reserves the right to refuse warranty claims against products or services that are obtained and/or used in contravention of the laws of any country. Repairs have 180 day warranty. If the unit sent in is still under its original warranty, then the new warranty is 180 days or to the end of the original two year warranty, depending on which is longer. For specific instructions about how to obtain warranty service for your device, please contact FELL support. THE WARRANTIES AND REMEDIES CONTAINED HEREIN ARE EXCLUSIVE AND IN LIEU OF ALL OTHER WARRANTIES EXPRESS, IMPLIED, OR STATUTORY, INCLUDING ANY LIABILITY ARISING UNDER ANY WARRANTY OF MERCHANTABILITY OR FITNESS FOR A PARTICULAR PURPOSE, STATUTORY OR OTHERWISE. THIS WARRANTY GIVES YOU SPECIFIC LEGAL RIGHTS, WHICH MAY VARY FROM STATE/COUNTRY TO STATE/COUNTRY. IN NO EVENT SHALL FELL, ITS SHAREHOLDERS, BOARD OF DIRECTORS, OR EXECUTIVE LEADERS BE LIABLE FOR ANY INCIDENTAL, SPECIAL, INDIRECT, OR CONSEQUENTIAL DAMAGES, WHETHER RESULTING FROM THE USE, MISUSE, OR INABILITY TO USE THIS PRODUCT OR FROM DEFECTS IN THE PRODUCT. SOME STATES/COUNTRIES DO NOT ALLOW THE EXCLUSION OF INCIDENTAL OR CONSEQUENTIAL DAMAGES, SO THE ABOVE LIMITATIONS MAY NOT APPLY TO YOU. SOME JURISDICTIONS DO NOT ALLOW LIMITATIONS ON HOW LONG A STATUTORY OR IMPLIED WARRANTY LASTS, SO THE ABOVE LIMITATION MAY NOT APPLY TO YOU. This limited warranty gives you specific rights. You may have additional rights under applicable law, and this limited warranty does not affect such rights. FELL retains the exclusive right to repair or replace (with a new or newly-overhauled replacement product) the device or software or offer a full refund of the purchase price at its sole discretion. SUCH REMEDY SHALL BE YOUR SOLE AND EXCLUSIVE REMEDY FOR ANY BREACH OF WARRANTY. To obtain warranty service, contact your local FELL authorized dealer or call FELL Support for shipping instructions and an Return Ticket Number. Securely pack the device and a copy of the original sales receipt, which is required as the proof of purchase for warranty repairs. Write the tracking number clearly on the outside of the package. Send the device, freight charges prepaid, to your nearest FELL address. See www.fellmarine.com to find your nearest address for return or contact your local FELL dealer.

ONLINE AUCTION PURCHASES: Products purchased through online auctions are not eligible for rebates or other special offers from FELL warranty coverage. Online auction confirmations are not accepted for warranty verification. To obtain warranty service, an original or copy of the sales receipt from the original retailer is required. FELL will not replace missing components from any package purchased through an online auction.

FOR INTERNATIONAL PURCHASES: A separate warranty may be provided by international distributors for devices purchased outside Norway or the United States depending on country. If applicable, this warranty is provided by the local in-country distributor and this distributor provides local service for your device. Distributor warranties are only valid in the area of intended distribution.

FOR AUSTRALIAN CONSUMERS: Our goods come with guarantees that cannot be excluded under the Australian Consumer Law. You are entitled to a replacement or refund for a major failure and for compensation for any other reasonably foreseeable loss or damage. You are also entitled to have the goods repaired or replaced if the goods fail to be of acceptable quality and the failure does not amount to a major failure. Goods presented for repair may be replaced by refurbished goods of the same type rather than being repaired. Refurbished parts may be used to repair the goods.

Warranty provider

FELL Technology AS Nedre Storgate 46, N-3015 Drammen, Norway
Org.No: 912 282 554 - Website: www.fellmarine.com - Tel: +47 32 82 82 80

Support: support@fellmarine.com

Additional information

www.fellmarine.com

www.fellmarine.com/support

Product contains CR2032 Lithium Metal Coin Cell Battery

Product category: Marine electronics

For products sold in EU/EEA/NZ

MOB+ xHUB **Model:** BU80115

MOB+ xFOB **Model:** GU80115

Tested and certified to comply with the CE Directive, R&TTE, RCM, R-NZ.

For products sold in AU

MOB+ xHUB **Model:** BU90115-AU

MOB+ xFOB **Model:** GU90115-AU

Tested and certified to comply with the RCM and FCC Standards.

R&TTE  **R-NZ**



For products sold in US/CA

MOB+ xHUB **Model:** BU90115 **FCC ID:** 2AFOZBU90115 **IC:** 20622-BU90115

MOB+ xFOB **Model:** GU90115 **FCC ID:** 2AFOZGU90115 **IC:** 20622-GU90115

Tested to comply with FCC standards.



WARNING: CHOKING HAZARD

Small parts. Not for children under 3 years



WARNING: KEEP AWAY FROM CHILDREN

Danger if swallowed.



Norway

FELL Technology AS

Nedre Storgate 46

N-3015, Drammen

www.fellmarine.com

mail@fellmarine.com

CE 0470



Designed in Norway, Printed in China