

FURUNO

OPERATOR'S MANUAL

MARINE RADAR

MODEL 1815

(Product Name: LCD RADAR)

 FURUNO ELECTRIC CO., LTD.



www.furuno.com

ECF

(Elemental Chlorine Free)

The paper used in this manual
is elemental chlorine free.

FURUNO ELECTRIC CO., LTD.

9-52 Ashihara-cho,
Nishinomiya, 662-8580, JAPAN

• FURUNO Authorized Distributor/Dealer

All rights reserved. Printed in Japan

Pub. No. OME-36660-D2

(ETMI) MODEL1815

A : FEB. 2017

D2 : JUL. 03, 2020



0 0 0 1 9 2 8 5 4 1 3

IMPORTANT NOTICES

General

- This manual has been authored with simplified grammar, to meet the needs of international users.
- The operator of this equipment must read and follow the descriptions in this manual. Wrong operation or maintenance can cancel the warranty or cause injury.
- Do not copy any part of this manual without written permission from FURUNO.
- If this manual is lost or worn, contact your dealer about replacement.
- The contents of this manual and equipment specifications can change without notice.
- The example screens (or illustrations) shown in this manual can be different from the screens you see on your display. The screens you see depend on your system configuration and equipment settings.
- Save this manual for future reference.
- Any modification of the equipment (including software) by persons not authorized by FURUNO will cancel the warranty.
- The following concern acts as our importer in Europe, as defined in DECISION No 768/2008/EC.
 - Name: FURUNO EUROPE B.V.
 - Address: Ridderhaven 19B, 2984 BT Ridderkerk, The Netherlands
- All brand and product names are trademarks, registered trademarks or service marks of their respective holders.

How to discard this product

Discard this product according to local regulations for the disposal of industrial waste. For disposal in the USA, see the homepage of the Electronics Industries Alliance (<http://www.eiae.org/>) for the correct method of disposal.

How to discard a used battery

Some FURUNO products have a battery(ies). To see if your product has a battery, see the chapter on Maintenance. Follow the instructions below if a battery is used. Tape the + and - terminals of battery before disposal to prevent fire, heat generation caused by short circuit.

In the European Union

The crossed-out trash can symbol indicates that all types of batteries must not be discarded in standard trash, or at a trash site. Take the used batteries to a battery collection site according to your national legislation and the Batteries Directive 2006/66/EU.

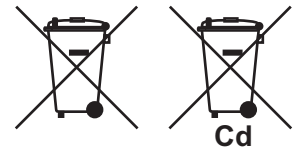

In the USA

The Mobius loop symbol (three chasing arrows) indicates that Ni-Cd and lead-acid rechargeable batteries must be recycled. Take the used batteries to a battery collection site according to local laws.

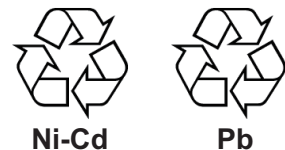

In the other countries

There are no international standards for the battery recycle symbol. The number of symbols can increase when the other countries make their own recycle symbols in the future.



SAFETY INSTRUCTIONS

Read these safety instructions before you operate or install the equipment.



WARNING

Indicates a condition that can cause death or serious injury if not avoided.



CAUTION

Indicates a condition that can cause minor or moderate injury if not avoided.



Warning, Caution



Prohibitive Action



Mandatory Action



WARNING

Radio Frequency Radiation Hazard

The radar antenna sends the electromagnetic radio frequency (RF) energy. This energy can be dangerous to you, especially your eyes. Do not look at the radiator or near the antenna when the antenna is rotating.

The distances at which RF radiation levels of 100 W/m², 50 W/m² and 10 W/m² exist are shown in the table.

Note: If the antenna unit is installed at a close distance in front of the wheel house, prevent the transmission in that area to protect passengers and crew from microwave radiation. Set the [Sector Blanks] in the [System] menu.

Distance to 100 W/m ² point	Distance to 50 W/m ² point	Distance to 10 W/m ² point
_____	_____	Worst case 85 cm



CAUTION

Observe the following compass safe distances to prevent deviation of a magnetic compass.

Unit	Standard	Steering
Display unit	0.45 m	0.30 m
Antenna unit	1.70 m	1.05 m



WARNING



Do not open the equipment.

The equipment uses high voltage that can cause electrical shock. Refer any repair work to a qualified technician.



Before turning on the radar, be sure no one is near the antenna.

Prevent the potential risk of being struck by the rotating antenna, which can result in serious injury or death.



If water leaks into the equipment or something is dropped into the equipment, immediately turn off the power at the switchboard.

Fire or electrical shock can result.



If the equipment is giving off smoke or fire, immediately turn off the power at the switchboard.

Fire or electrical shock can result.





Do not disassemble or modify the equipment.



Fire, electrical shock or serious injury can result.





Do not place operate the equipment with wet hands.

Electrical shock can result.

 WARNING	
	Use the correct fuse. Use of a wrong fuse can result in fire or damage to the equipment.
	Do not place liquid-filled containers on the equipment. Fire or electrical shock can result if a liquid spills into the equipment.

 CAUTION	
	The guard zone alarm is an effective aid to anti-collision. Its use does not relieve the operator of the responsibility to keep a vigilant watch on his or her surroundings.
	The data presented by this equipment is intended as a source of navigation information. The prudent navigator never relies exclusively on any one source of navigation information, for safety of vessel and crew.

Target Tracking (TT) safety information

 WARNING	
	The TT function is a valuable aid to navigation. However, the navigator must check all aids available to avoid collision. - The TT automatically tracks an automatically or manually acquired radar target and calculates its course and speed, indicating them with a vector. Since the data generated by the TT depends on the selected radar targets, the radar must be optimally tuned for use with the TT, to ensure required targets will not be lost or unnecessary targets, like sea returns and noise, will not be acquired and tracked. - A target is not always a landmass, reef, ship, but can also be returns from the sea surface and from clutter. As the level of clutter changes with the environment, the operator must correctly adjust the sea and rain clutter controls and the gain control so that the target echoes do not disappear from the radar screen.

 CAUTION	
The plotting accuracy and response of this TT meets IMO standards. Tracking accuracy is affected by the following:	
<ul style="list-style-type: none"> • Tracking accuracy is affected by course change. One to two minutes is required to restore vectors to full accuracy after an abrupt course change. (The actual amount depends on gyrocompass specifications.) • The amount of tracking delay is inversely proportional to the relative speed of the target. Delay is approx. 15-30 seconds for the higher relative speed; approx. 30-60 seconds for the lower relative speed. The following factors can affect accuracy: <ul style="list-style-type: none"> - Echo intensity - Radar transmission pulse length - Radar bearing error - Heading sensor error - Course change (own ship and targets) 	

Warning Label(s)

Warning label(s) is(are) attached to the equipment. Do not remove the label(s). If a label is missing or damaged, contact a FURUNO agent or dealer about replacement.



Name: Warning Sticker
Type: 03-129-1001-3
Code No.: 100-236-743-10

TFT display

The high quality TFT (Thin Film Transistor) LCD displays 99.99% of its picture elements. The remaining 0.01% may drop out or light. However, this is an inherent property of the TFT; it is not a sign of malfunction.

TABLE OF CONTENTS

FOREWORD	viii
SYSTEM CONFIGURATION	x
1. INSTALLATION	1-1
1.1 Equipment List	1-1
1.2 How to Install the Equipment	1-2
1.2.1 Display unit.....	1-2
1.2.2 Antenna unit.....	1-5
1.3 Wiring.....	1-10
1.4 Input Signal	1-13
1.4.1 NMEA I/O sentences.....	1-13
1.5 Initial Settings.....	1-14
1.5.1 How to select language.....	1-14
1.5.2 How to select radar application	1-16
1.5.3 Initial settings	1-16
1.6 Optional Equipment.....	1-19
1.6.1 External buzzer	1-19
2. OPERATION	2-1
2.1 Controls.....	2-1
2.2 How to Turn the Radar On/Off	2-2
2.3 TX/Standby	2-2
2.4 Display Indications	2-3
2.5 How to Adjust Display Brilliance, Panel Dimmer.....	2-4
2.6 Menu Description	2-4
2.7 Tuning	2-6
2.8 Display Modes.....	2-7
2.8.1 How to select the display mode	2-7
2.8.2 Description of display modes	2-8
2.9 How to Select the Range Scale	2-10
2.10 How to Adjust the Gain (sensitivity)	2-10
2.11 How to Reduce the Sea Clutter.....	2-11
2.12 How to Reduce the Rain Clutter.....	2-12
2.13 Cursor	2-13
2.14 How to Temporarily Erase the Heading Line	2-14
2.15 Interference Rejector.....	2-14
2.16 Noise Rejector.....	2-15
2.17 How to Measure the Range to a Target	2-15
2.17.1 How to adjust range ring brilliance	2-15
2.17.2 How to measure the range with a VRM	2-16
2.17.3 How to select VRM unit.....	2-17
2.18 How to Measure the Bearing to a Target	2-17
2.18.1 How to measure the bearing with an EBL.....	2-17
2.18.2 EBL reference	2-18
2.19 How to Measure the Range and Bearing Between Two Targets	2-19
2.20 Target Alarm	2-20
2.20.1 How to set a target alarm zone	2-20
2.20.2 How to stop the audio alarm	2-21
2.20.3 How to select the alarm type.....	2-21
2.20.4 How to sleep a target alarm temporarily	2-22
2.20.5 How to deactivate a target alarm	2-22
2.20.6 How to select the target strength which triggers a target alarm	2-22

2.20.7	How to turn the buzzer on/off	2-22
2.21	How to Off-center the Display.....	2-23
2.21.1	How to select the off-center mode.....	2-23
2.21.2	How to off-center the display	2-23
2.22	Zoom	2-24
2.22.1	Zoom reference	2-24
2.22.2	How to zoom	2-25
2.23	Echo Stretch	2-27
2.24	Target Trails	2-27
2.24.1	Trail time.....	2-27
2.24.2	Trail mode	2-28
2.24.3	Trail gradation	2-29
2.24.4	Trail color.....	2-29
2.24.5	Trail level	2-29
2.24.6	How to restart, stop the trails.....	2-29
2.24.7	Narrow trails	2-30
2.24.8	Own ship trail.....	2-30
2.24.9	How to erase all trails	2-31
2.25	How to Program the FUNC Key	2-31
2.26	Echo Average	2-32
2.27	Wiper	2-32
2.28	Display-Curve	2-33
2.29	Own Ship and Barge Mark	2-33
2.29.1	How to show the own ship mark.....	2-33
2.29.2	How to show the barge mark.....	2-34
2.30	Watchman	2-35
2.31	Alert Status	2-36
2.32	Color Selections	2-38
2.32.1	Preset colors	2-38
2.32.2	Custom colors	2-38
2.33	Echo Area.....	2-39
2.34	Initial Sub Menu.....	2-39
2.34.1	How to open the Initial sub menu	2-39
2.34.2	Description of Initial sub menu	2-40
2.35	Sector Blank	2-41
2.36	Other Menu Items.....	2-42
2.36.1	Brill/Color menu	2-42
2.36.2	Display menu.....	2-43
2.36.3	Echo menu	2-43
2.36.4	Units menu	2-44
2.37	Navigation Data	2-45
2.37.1	Navigation data during standby	2-45
2.37.2	Navigation data at the bottom of the screen.....	2-45
2.38	Waypoint Mark.....	2-46
2.39	How to Send the Target Position and Enter the Origin Mark.....	2-47
3.	HOW TO INTERPRET THE RADAR DISPLAY.....	3-1
3.1	General.....	3-1
3.1.1	Minimum and maximum ranges	3-1
3.1.2	Radar resolution	3-2
3.1.3	Bearing accuracy.....	3-3
3.1.4	Range measurement.....	3-3
3.2	False Echoes.....	3-3
3.2.1	Multiple echoes	3-3
3.2.2	Sidelobe echoes.....	3-4
3.2.3	Virtual image	3-4

TABLE OF CONTENTS

3.2.4	Shadow sector	3-5
3.3	SART (Search and Rescue Transponder)	3-6
3.3.1	SART description	3-6
3.3.2	General remarks on receiving SART	3-7
3.4	RACON	3-8
4.	TT OPERATION	4-1
4.1	Precautions	4-1
4.2	Controls for Use with TT	4-1
4.3	TT Display On/Off	4-2
4.4	TT Symbol Color	4-2
4.5	How to Acquire and Track the Targets.....	4-2
4.5.1	Manual acquisition	4-2
4.5.2	Automatic acquisition	4-3
4.6	How to Stop Tracking a TT	4-3
4.6.1	How to stop tracking a single target.....	4-3
4.6.2	How to stop tracking all targets	4-3
4.7	Lost Target.....	4-4
4.8	Vector Attributes.....	4-4
4.8.1	What is a vector?	4-4
4.8.2	Vector time and vector reference	4-5
4.8.3	Own ship vector	4-6
4.9	Past Position Display (target past position).....	4-6
4.10	TT Data	4-7
4.11	CPA/TCPA Alarm.....	4-8
4.12	Proximity Alarm	4-9
5.	AIS OPERATION	5-1
5.1	AIS Display On/Off	5-1
5.2	AIS Symbols.....	5-2
5.3	Activating, Sleeping Targets	5-3
5.4	AIS Target Data	5-4
5.5	How to Sort Targets	5-4
5.6	Display Range.....	5-5
5.7	How to Display the Targets within a Specific Sector.....	5-5
5.8	Number of Targets to Display	5-6
5.9	Vector Attributes.....	5-6
5.9.1	What is a vector?	5-6
5.9.2	Vector time and vector reference	5-6
5.10	Past Position Display (target past position).....	5-7
5.11	CPA/TCPA Alarm.....	5-8
5.12	Proximity Alarm	5-9
5.13	Lost Target.....	5-9
5.14	Symbol Color.....	5-10
5.15	How to Ignore Slow Targets.....	5-10
6.	GPS OPERATION.....	6-1
6.1	Navigator Mode.....	6-1
6.2	Datum.....	6-1
6.3	WAAS Setup	6-2
6.4	Satellite Monitor	6-3
6.5	Self Test.....	6-4
6.6	Cold Start.....	6-4

7. MAINTENANCE, TROUBLESHOOTING	7-1
7.1 Preventive Maintenance	7-2
7.2 Fuse Replacement	7-2
7.3 Magnetron Life.....	7-3
7.4 Simple Troubleshooting.....	7-3
7.5 Advanced-level Troubleshooting	7-4
7.6 Self Test	7-5
7.7 LCD Test	7-7
7.8 Radar Sensor Test	7-8
APPENDIX 1 MENU TREE	AP-1
APPENDIX 2 GEODETIC CHART LIST	AP-5
APPENDIX 3 DIGITAL INTERFACE	AP-7
APPENDIX 4 JIS CABLE GUIDE	AP-14
APPENDIX 5 RADIO REGULATORY INFORMATION	AP-15
APPENDIX 6 ALERT LIST.....	AP-17
SPECIFICATIONS	SP-1
PACKING LIST	A-1
OUTLINE DRAWINGS	D-1
INTERCONNECTION DIAGRAM	S-1
INDEX	IN-1

FOREWORD

A Word to the Owner of the MODEL1815 Marine Radar

Congratulations on your choice of the FURUNO MODEL1815 Marine Radar. We are confident you will see why the FURUNO name has become synonymous with quality and reliability.

Since 1948, FURUNO Electric Company has enjoyed an enviable reputation for innovative and dependable marine electronics equipment. This dedication to excellence is furthered by our extensive global network of agents and dealers.

Your equipment is designed and constructed to meet the rigorous demands of the marine environment. However, no machine can perform its intended function unless properly installed and maintained. Please carefully read and follow the operation and maintenance procedures set forth in this manual.

We would appreciate feedback from you, the end-user, about whether we are achieving our purposes.

Thank you for considering and purchasing FURUNO equipment.

Features

The main features are as shown below.

- The radar is operated with keys, knobs and a Cursorpad.
- Easy-to-view 8.4 inch LCD.
- Echo area display with full screen provides observation of a wider range around the vessel.
- User-programmable function key
- AIS data available with connection of FURUNO AIS Transponder/Receiver.

Program No.

Display unit: 0359375-01.**

Antenna unit: 0359367-01.**

**=Minor modification

CE declaration

With regards to CE declarations, please refer to our website (www.furuno.com) for further information about RoHS conformity declarations.

Radar function availability

The MODEL 1815 is available in two types, [River] (river use) and [Sea] (sea use). Some functions may not be available depending on the type selected. See the table below for function and availability.

Type and function availability

Function	Type		Paragraph, section reference
	River	Sea	
Automatic menu closure	Menu closes automatically when no operation is detected after 10 seconds.		
Effective radius dot count	240 dots		
Echo color	Select the echo display color, among yellow, green, orange, and multi-color		subsection 2.32.2
Echo color customizing	Can customize the echo display color.		subsection 2.36.1
Echo area	Select the display area from [Normal] or [Full Screen].		section 2.33
Text display	Can show or hide the base text indications.		subsection 2.36.2
Range preset	Select the radar ranges to use.		subsection 2.34.2
Unit defaults 1) range 2) speed	1) KM 2) km/h, m/s	1) NM 2) kn	subsection 2.36.4
Bearing scale	Graduation every 1°, 5°, 10°, 30°, no numeric indication, displayed in the effective radius		
VRM unit	Can set the VRM unit independently from the range unit.		subsection 2.17.3
Range unit	Can change the unit of range measurement.		subsection 2.36.4
AIS symbol color	Select the AIS symbol color from [Green], [Red], [Blue], [White] or [Black].		section 5.14
Vector reference	Select the display mode for the vector from [Relative] or [True].		subsection 4.8.2
TT number	Empty numbers numbered in ascending order		
Heading line erasure	Heading line, EBL, VRM, guard zone, etc. temporarily erased.		section 2.14

中文字型由北京字研技术开发中心提供

Note on Chinese font: The Chinese font (GB 18030) used in this equipment is DynaComware Corporation's bitmap font.

Conventions used in this manual

- Keys and controls are shown in boldface type. For example, the **MODE** key.
- Menu names and menu items are put in brackets. For example, the [Echo] menu.
- To select a menu, menu item or option, you press the ▲ or ▼ symbol on the Cursorpad. For the sake of brevity, we substitute “select” when it is necessary to use those symbols on the Cursorpad. For example, “Push ▲ or ▼ on the Cursorpad to select [Echo Stretch]”...is written in the manual as “Select [Echo Stretch]”...

SYSTEM CONFIGURATION

Basic configuration is shown below with solid line.

Equipment category

Antenna Unit: Exposed to the weather
 Other Equipment: Protected from the weather

- : Standard supply
- : Option or local supply

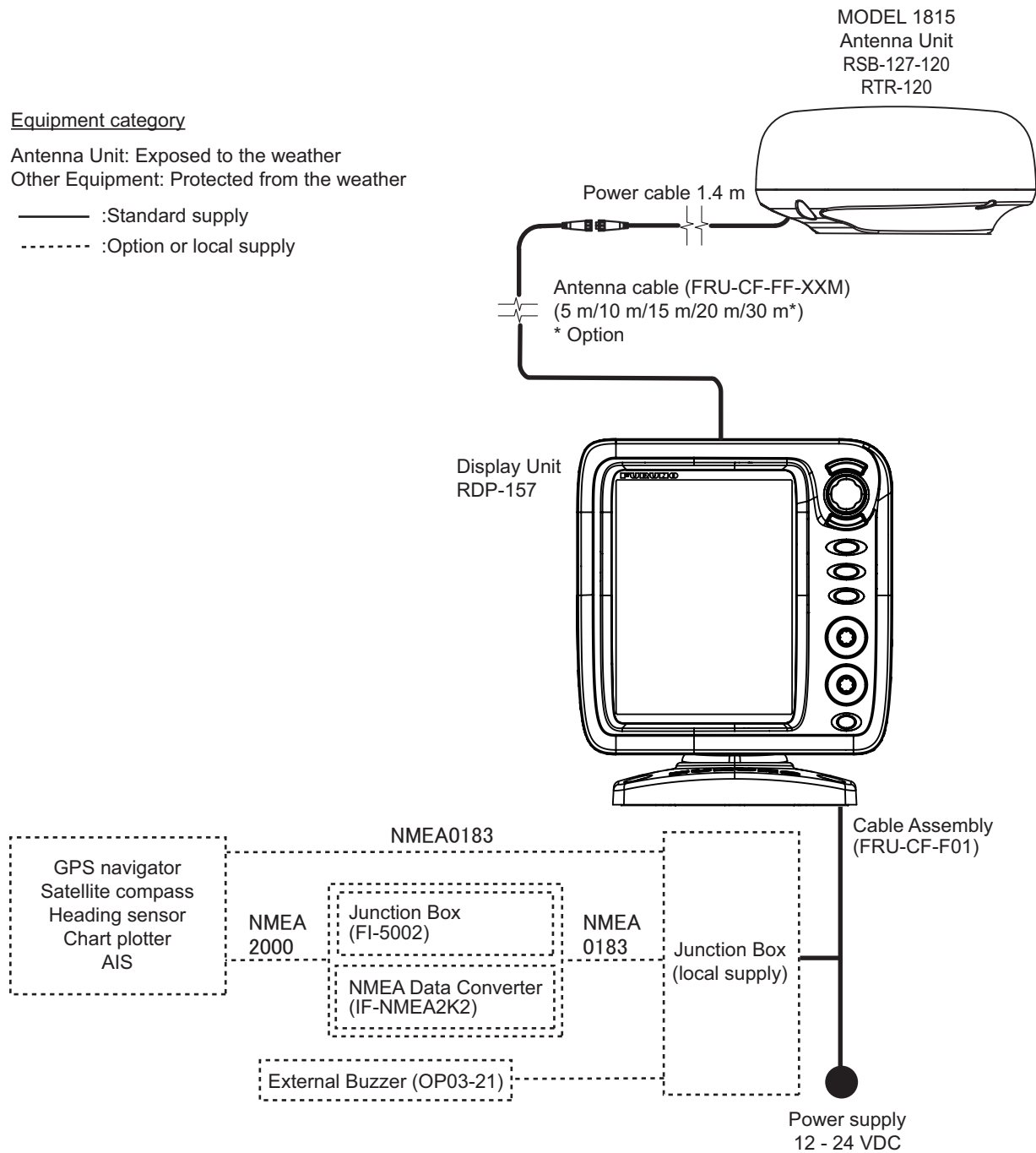

Standard System Configuration

MODEL 1815
Antenna Unit
RSB-127-120
RTR-120

Equipment category

Antenna Unit: Exposed to the weather
Other Equipment: Protected from the weather

———— : Standard supply
- - - - - : Option or local supply

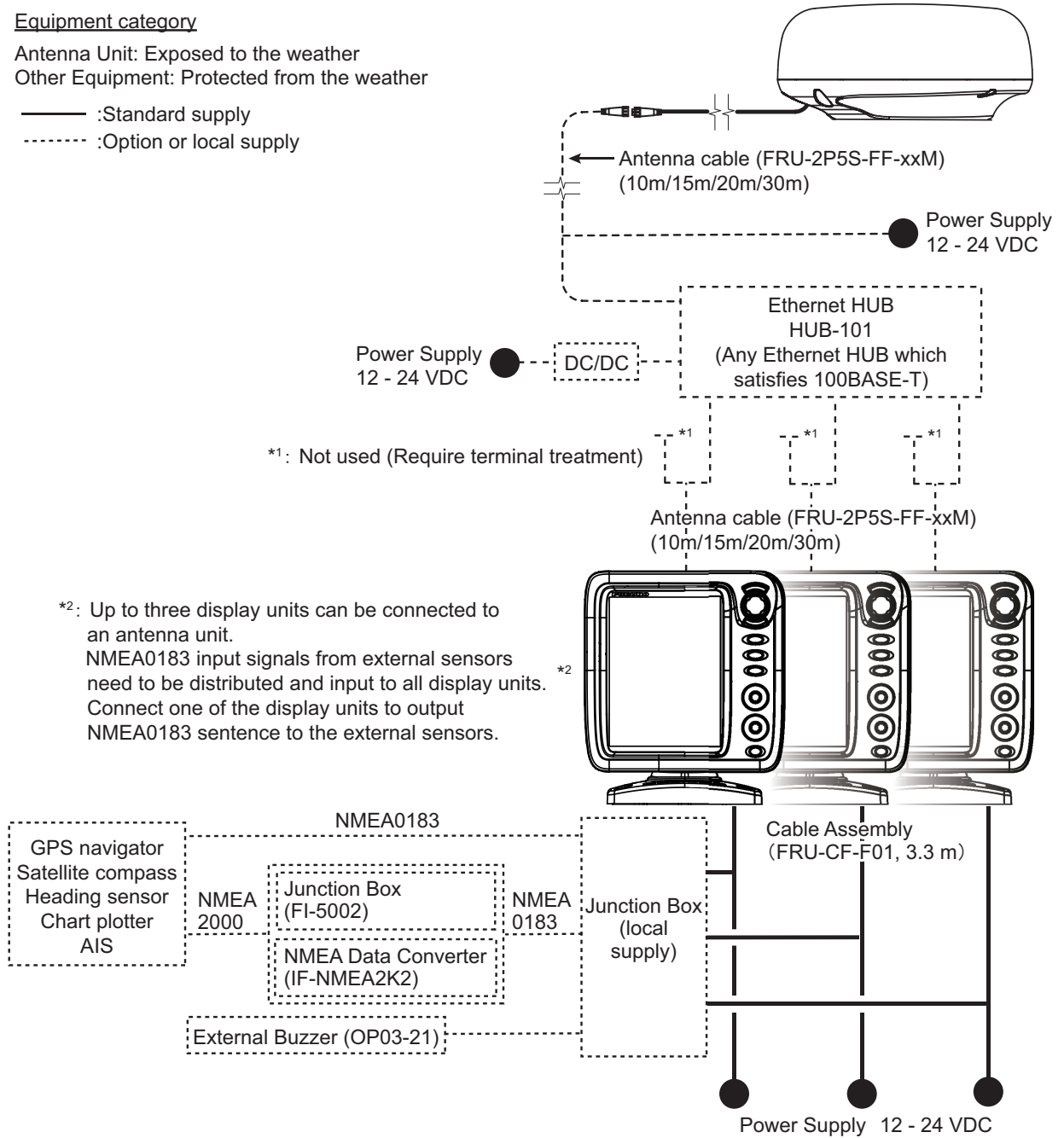

*2: Up to three display units can be connected to an antenna unit.
NMEA0183 input signals from external sensors need to be distributed and input to all display units.
Connect one of the display units to output NMEA0183 sentence to the external sensors.

System Configuration for connecting multiple display units

This page is intentionally left blank.

1. INSTALLATION

1.1 Equipment List

Standard supply

Name	Type	Code No.	Qty	Remarks
Display Unit	RDP-157	—	1	
Antenna Unit	RSB-127-120	—	1	
Installation Materials	CP03-35701	001-351-480	1	For antenna unit
	CP03-37501	001-492-650	1	For display unit
	CP03-37630	001-034-835	Select one	5 m cable
	CP03-37600	000-033-122		10 m cable
	CP03-37610	000-033-123		15 m cable
	CP03-37620	000-033-124		20 m cable
Spare Parts	SP03-19301	001-534-920	1	Fuse for display unit
Accessories	FP03-12501	001-492-680	1	For display unit

Optional supply

Name	Type	Code No.	Qty	Remarks
Radome Mounting Bracket	OP03-209	001-078-350	1	For fixing antenna to mast
External Buzzer	OP03-21	000-030-097	1	
NMEA Data Converter	IF-NMEA2K2	000-020-510	1	
Junction Box	FI-5002	000-010-765	1	
Cable Assy.	FRU-CF-FF-05M	001-496-040	Select one	5 m cable
	FRU-CF-FF-10M	001-489-540		10 m cable
	FRU-CF-FF-15M	001-489-550		15 m cable
	FRU-CF-FF-20M	001-489-560		20 m cable
	FRU-CF-FF-30M	001-464-270		30 m cable
Flush Mount Kit	OP03-242	001-464-280	1	
Cable Assy.*	FRU-2P5S-FF-10M-A	001-512-610	Select one	10 m cable
	FRU-2P5S-FF-15M-A	001-512-630		15 m cable
	FRU-2P5S-FF-20M-A	001-512-670		20 m cable
	FRU-2P5S-FF-30M-A	001-513-500		30 m cable
Ethernet HUB*	HUB-101	000-011-762	1	

*: Required for connecting multiple display units to an antenna unit.

1.2 How to Install the Equipment

1.2.1 Display unit



The display unit can be installed on a desktop or flush mounted in a console. Do not install the unit on the overhead or a bulkhead. Select a suitable location for the unit considering the following points:

- Select a location where the controls can be easily operated.
- Locate the unit away from the direct wind from air conditioners.
- The temperature range in the mounting location should be -15°C to 55°C (5°F to 55°F).
- Locate the unit away from devices that emit active gas.
- The mounting location must be well ventilated.
- Select a location where vibration and shock are minimal.
- A magnetic compass will be affected if the display unit is placed too close to the compass. Observe the compass safe distances in the safety instructions to prevent interference to the compass.
- Locate the unit away from direct sunlight to prevent heat build up inside the cabinet and condensation in the display.
- Keep the unit away from water and water splash. (The unit complies with waterproofing specification IPX5.)

Desktop mount

Fasten the unit to the mounting location as shown below. For mounting dimensions, see the outline drawing at the back of this manual.

1. Fix the hanger assembly to a desktop with four self-tapping screws ($\phi 5 \times 25$, supplied). Be sure to follow the recommended maintenance space show in the outline drawing. Insufficient space may damage the connectors when disconnecting and reconnecting them.
2. Loosely screw the knob into the hanger assembly.

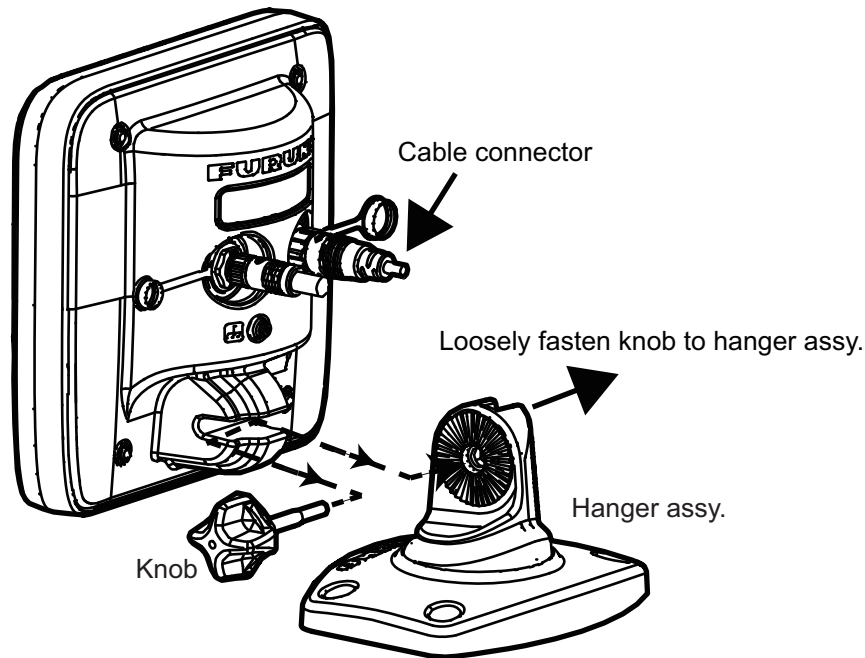

3. Set the channel in the display unit to the hanger assembly.
4. Adjust the angle of the display unit for comfortable viewing angle.
Note: Do not tilt the unit 90-degree backward or forward. The cable connector may be damaged if it contacts the bracket.
5. Tighten the knob.
6. Attach the hard cover to the display unit to protect the unit when it is not in use.

1. INSTALLATION

Flush mount (in a console)

The flush mount kit (option) is required to mount the unit in a console. Select a flat mounting location, and install the unit as shown below.

Note: It is recommended to set up a dedicated breaker when flush mounting the unit, since it will be difficult to disconnect cables after the unit is installed.

1. Using the paper template (supplied), make a cutout in the mounting location.
2. Unfasten four washer head screws on the rear of the display unit to remove the hanger cover and the cover sponge.

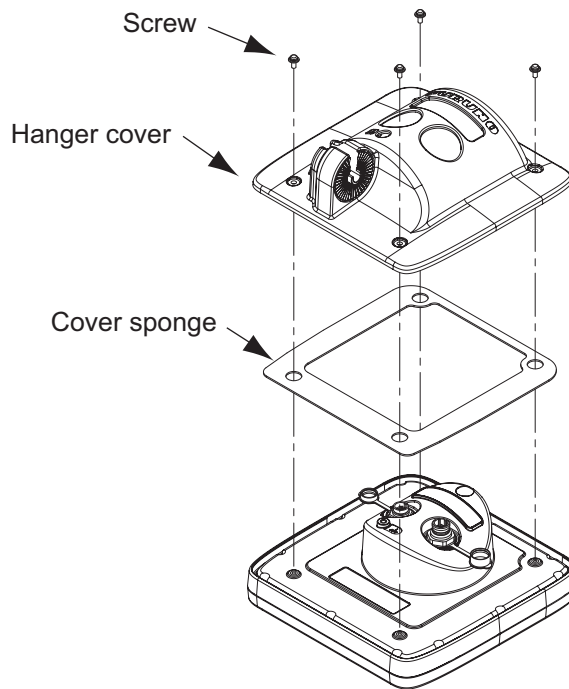

3. Set the flush mounting sponge (supplied) to the display unit.
4. Screw four threaded rods (supplied) to the display unit.
5. Set the display unit to the cutout.
6. Fasten the display unit from behind with four sets of flat washers, spring washers and wing nuts (supplied).

1.2.2 Antenna unit

Select a mounting location for the antenna unit considering the following points.

- Install the unit on a common mast, radar mast, etc.
- Install the antenna unit on a solid location, for example radar arch or on a mast on a platform. (For sailboats, a mounting bracket is optionally available.) You must put the antenna unit where there is a good complete view. Make sure that no part of the superstructure is within the scanning beam. Any obstruction causes shadow sectors. For example, a mast with a diameter smaller than the horizontal beam width causes only a small blind sector. A horizontal spreader or crosstrees in the same horizontal plane creates a large obstruction. Install the antenna unit above a horizontal spreader or crosstrees.

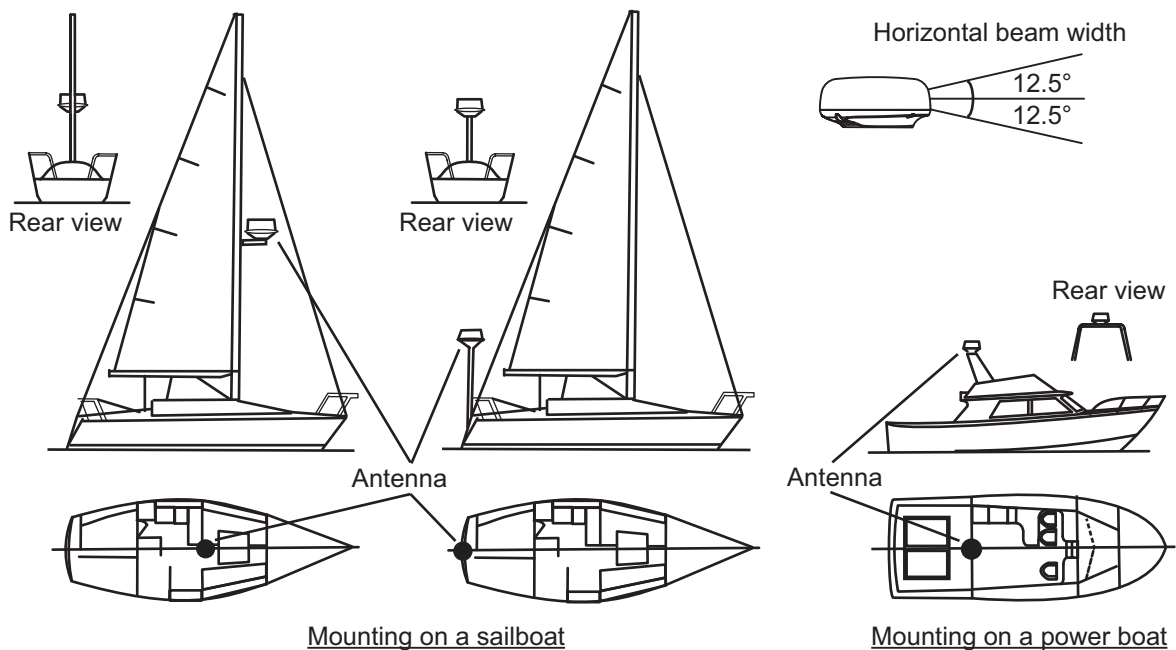

- To avoid electrical interference, do not run the antenna cable near other electrical equipment. Also do not run the cable in parallel to power cables.
- Do not install the unit where its motor noise may affect crew or passengers.
- As much as possible install the unit on the ship's centerline, to prevent misplacement of echoes (wrong bearing) on the display.
- Make sure the mounting location does not allow water to accumulate at the mounting platform.
- A magnetic compass will be affected if the display unit is placed too close to the compass. Observe the compass safe distances in the safety instructions to prevent interference to the compass.
- Do not paint the radome.
- Be sure to follow the recommended maintenance space shown in the outline drawing at the back of this manual.
- If the unit is installed on a large vessel observe the following points.
 - The antenna cable comes in lengths of 5 m/10 m/15 m/20 m (30 m optionally available). Consider the length of the cable when selecting a mounting location.
 - Keep the unit away from smoke and exhaust stacks. Hot air affects antenna performance. Hot air can also damage the unit. The temperature at the mounting location should not exceed 55°C(131°F).

1. INSTALLATION

Tools and materials for mounting

Name	Usage
Electric drill	Drill holes for mounting. Drill bit: $\phi 11$ mm
Hexagonal wrench	Fastening bolts: Diagonal: 6 mm
Silicon sealant	For coating exposed parts of bolts

How to mount the antenna unit

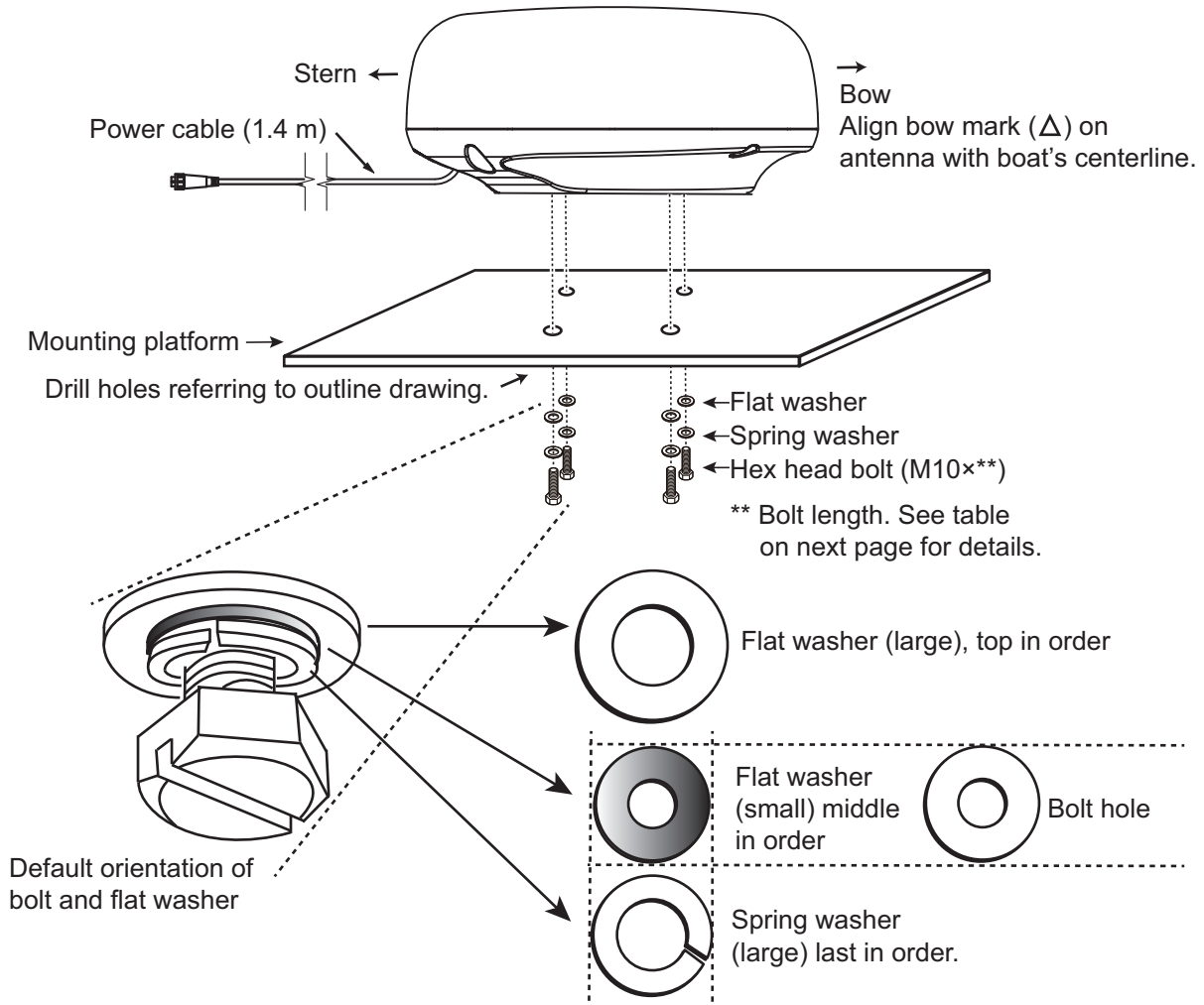

Note: The outer diameter of the small flat washer is the same size as the bolt hole. If the radome is put upside down with only the small flat washer and hex bolt in place, the hex bolt and flat washer may protrude into the radome and damage the RT unit. For this reason, DO NOT put the radome upside down when carrying the radome.

- From the bottom of the radome, remove spring washers (M10), flat washers (M10) and hex head bolts (M10×**).
 **: The length of the hex head bolt depends on the thickness of the platform.
 See the table below for platform thickness and bolt to use.

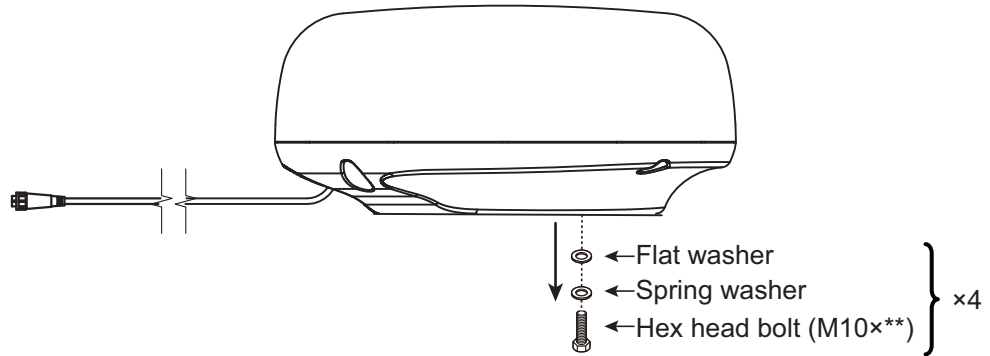

- Use the mounting template (supplied) to mark the location of fixing holes in the mounting platform. Be sure to drill the holes parallel with the bow.
- Lay the antenna unit on the mounting platform with the bow mark(△) on the antenna unit facing the bow.
- Use hex bolts*, flat washers and spring washers (removed at step 1) to fasten the radar sensor to the platform. The torque for the bolts must be 19.6 to 24.5 Nm. Apply marine sealant (local supply) to hex bolt, flat washer and spring washer as shown below.

*See the figure below to determine the bolt length to use.

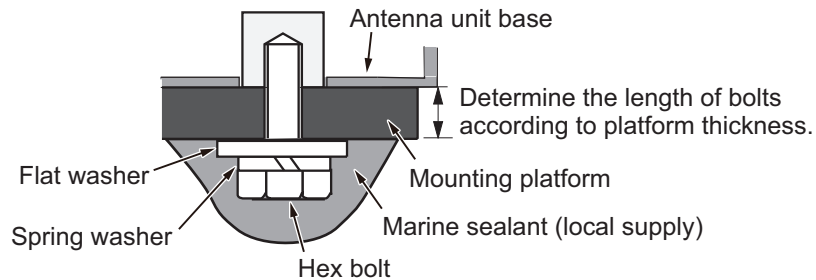

Platform thickness	Bolt size to use
5 mm or less	M10×20
6 to 10 mm	M10×25
More than 10 mm	Local supply

- Connect the power cable to the antenna unit.

1. INSTALLATION

How to connect the cable assy. to the antenna unit

Observe the following guidelines for connecting the cable assy. to the antenna unit.

- Do not fasten the cable to the hull.
- Using a cable tie, fasten the cable to the mast, etc. at the neck of each connector.
- If the cable is passed through a mast on a sailboat, be sure the cable does not touch ropes (sheet, halyard, etc.).
- The connectors must not strike any part of the vessel by wind, etc.
- The load applied to the connectors must not be more than their own weight.
- The cable must be fixed so no tension is applied to the connectors. To prevent tension, make a loop in the cable close to the sensor and tie the loop with cable ties, as in the figure below.

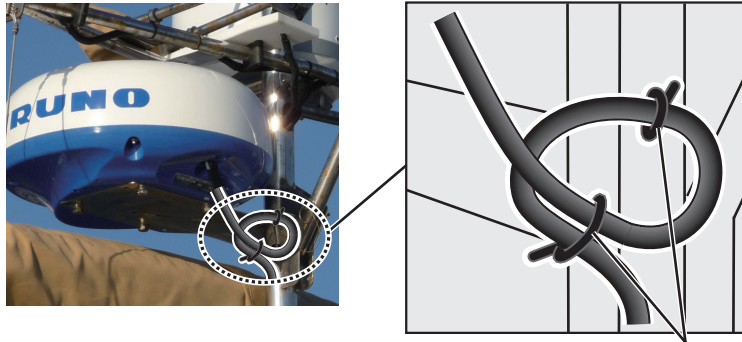

Loop cable and tie the loop with cable ties. (Min. bending radius: 80 mm)

- Wrap the junction of the connectors and the connectors with self vulcanizing tape for waterproofing.

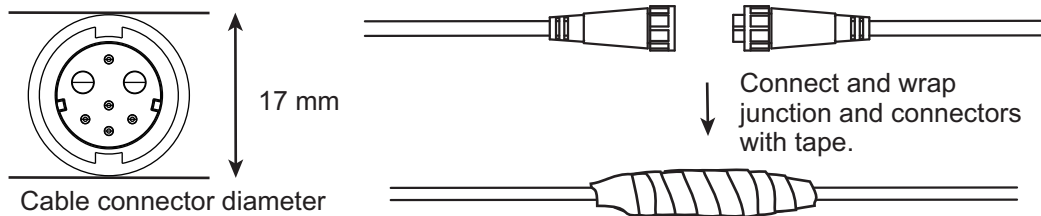

How to use the radome mounting bracket (option)

The optional radome mount lets you fasten the radar sensor to a mast on a sailboat. Refer to the outline drawing at the back of this manual.

Name, Type: Radome Mount, OP03-209

Code No.: 001-078-350

Name	Type	Code No.	Qty
Mounting plate	03-018-9001-0	100-206-740-10	1
Support plate (1)	03-018-9005-0	100-206-780-10	1
Support plate (2)	03-018-9006-0	100-206-790-10	1
Bracket (1)	03-028-9101-1	100-206-812-10	1
Bracket (2)	03-028-9102-2	100-206-822-10	1
Fixing plate	03-028-9103-1	100-206-832-10	2
Hex bolt w/washer	M8×20 SUS304	000-162-955-10	10
Hex bolt w/washer	M4×12 SUS304	000-162-956-10	4

How to assemble the bracket:

1. Fasten the fixing plates to the brackets (1) and (2) with four M4×12 hex bolts.
2. Fit brackets (1) and (2) loosely with support plates (1) and (2) using four M4×12 hex bolts, so that the gap between the brackets can be adjusted.
3. Place the mounting plate on the brackets and fix the plate loosely with four M8×20 hex bolts.

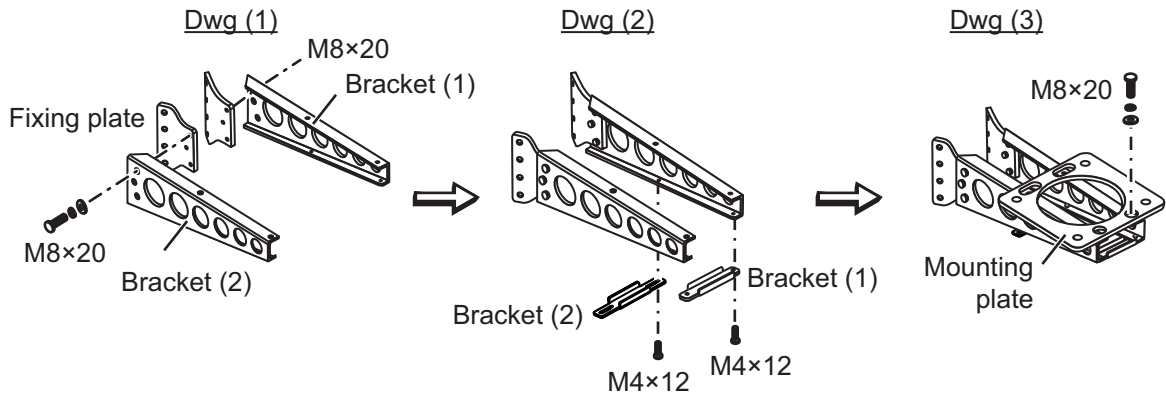
**How to fasten the bracket to the mast:**

1. Drill eight holes of 6.5 mm into the mast. Fasten the bracket to the mast with eight stainless steel rivets (local supply) whose diameter is 6.4 mm.
2. Tighten the bolts on the bracket.
3. Fasten the antenna unit to the bracket with bolts (M10×25).

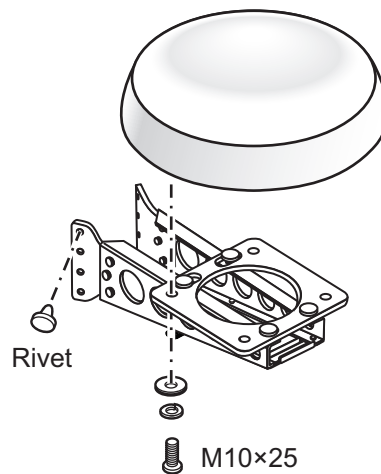

1.3 Wiring

Use the supplied cable FRU-CF-F01 to connect a satellite compass, heading sensor, GPS navigator, external buzzer, and power supply to the 12-24 VDC/NMEA connector.

Connect the antenna cable (FU-CF-FF-xxM (available in lengths of 5 m/10 m/15 m/20 m; 30 m optionally available) to the antenna port. See the interconnection diagram at the back of this manual for details. Leave slack in the cable to ease maintenance.

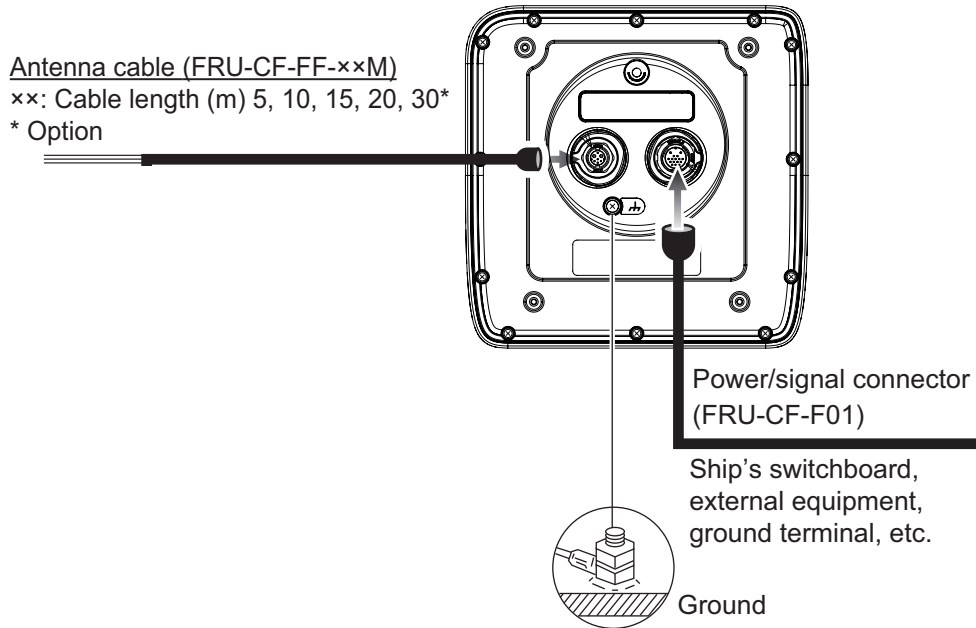

Note 1: The display unit comes with connector caps. Use the caps to cover the connectors whenever the display unit is removed from the boat.

Note 2: Cut unused wires and wrap them with vinyl tape to keep them from touching one another.

Note 3: Use care when disconnecting cables to prevent damage to their connectors.

Note 4: When an NMEA equipment uses ± 12 V supplied from this equipment, do not connect the cable earth of the signal line of that equipment (for example, satellite compass) to 12 V-P(+)/12 V_M(-).

Note 5: Do not shorten the supplied cable.

Connector	Color	Remarks
1	DC-P-IN(+)	Red
2	DC-M-IN(-)	Black
3	TD1-A	White
4	TD1-B	Blue
5	RD1-H	Yellow
6	RD1-C	Light Green
7	TD2-A	White / Orange
8	TD2-B	Blue / Orange
9	RD2-H	Yellow / Orange
10	RD2-C	Light Green / Orange
11	RD3-H	Yellow / Gray
12	RD3-C	Light Green / Gray

Connector		Color	Remarks
13	12V-P(+)	Red / White	Power output, 12 VDC
14	12V-M(-)	Black / White	
15	EXT-BUZZ-EN	Purple	External buzzer
16	SHIELD	Black	Drain wire, (Connect to ground terminal of ship's switchboard.)

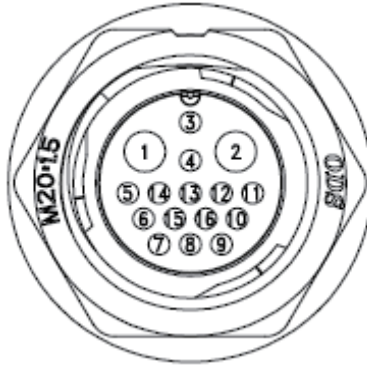

Ground





CAUTION

Do not fail to ground the display unit.

If the ground is poor or there is no ground, the radar and other equipment may pick up interference.

Grounding guidelines:

- The ground wire (local supply) should be 2sq or higher.
- The length of the ground wire should be as short as possible.
- For an FRP vessel, fasten a 20 cm×30 cm earthing plate to the outside of the boat's hull and attach the ground wire to a bolt on the plate.
- Attach a closed-end lug () to the ground wire. Do not use an open-end lug ().
- External equipment whose signal line is connected to ground cannot be directly connected to this equipment if the positive polarity of the vessel's DC power is connected to ground.

How to connect the display unit to the power supply

Connect the cable assy. to the power supply (12 - 24 VDC) as shown below.

- **Red cable:** Connect to the positive (+) terminal.
- **Black cable:** Connect to the negative (-) terminal.

1. INSTALLATION

- **Black cable:** Shield wire. Connect to ground.

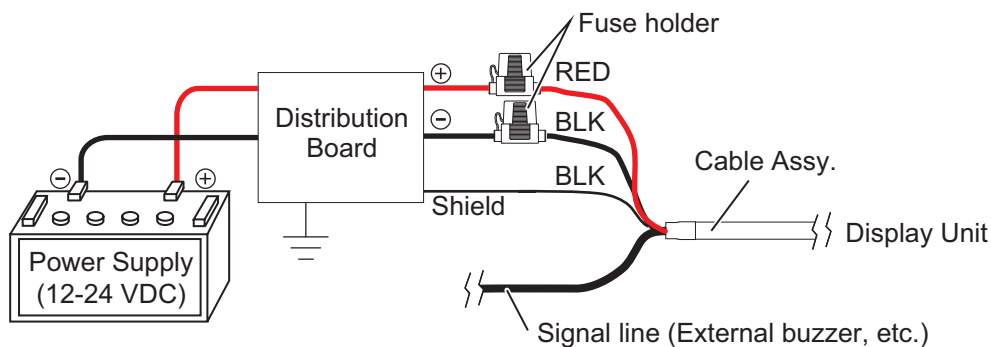

Note: This equipment cannot be used with a power supply whose voltage is greater than 24 VDC.

For connecting multiple display units

When connecting multiple display units, please refer to the system configurations on page xi. Connect the antenna cable (FRU-2P5S-FF-xxM (available in lengths of 10 m/ 15 m/20 m/ 30 m) to the antenna port. See the guidelines on page 1-8 and the inter-connection diagram at the back of this manual for details. Leave slack in the cable to ease maintenance.

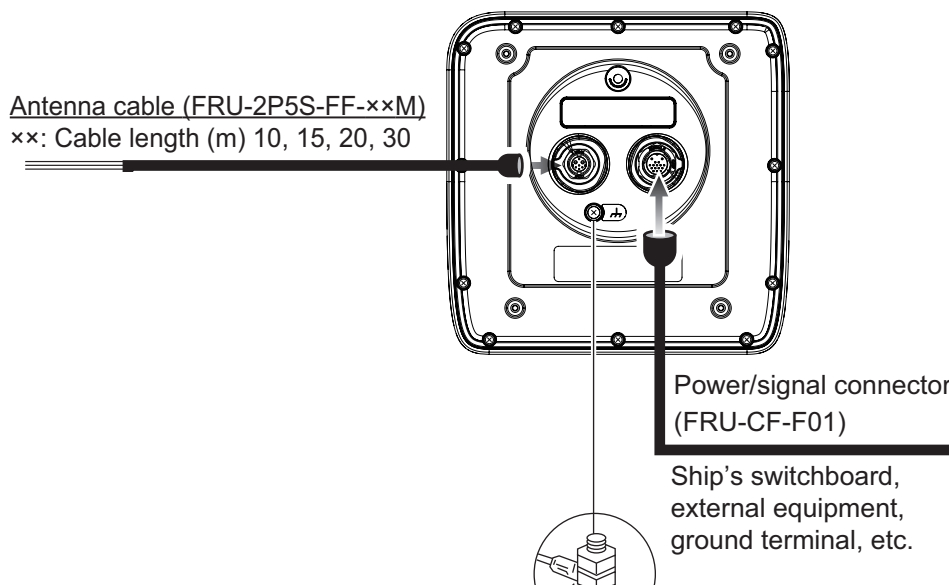

Check the following points when connecting other display units.

- Up to three display units can be connected to a radar scanner.
- Two cables, between the radar scanner and an Ethernet HUB, and between the Ethernet HUB and the display units are required.
- NMEA0183 input signals from external sensors need to be distributed and input to all display units.
- Connect one of the display units to output NMEA0183 sentence to the external sensors. The display unit is the main unit. (The sub display units cannot output NMEA0183 sentence to the external sensors.)

Note 1: Do not connect to the NAVnet series network.

Note 2: The cable(s) between the display unit and ethernet hub carries the direct current from ship's main (12 VDC - 24 VDC). Grounding is required for those cables.

1.4 Input Signal

This radar accepts input signals in NMEA format. Three NMEA ports are provided for input signals, and the method of sentence handling is common to all ports.

1.4.1 NMEA I/O sentences

NMEA1/NMEA2 Input Sentence

- Baud rate: 4800/38400
- NMEA 0183 (IEC 61162-2)

Sentence	Description
ALR	Set alarm state
BWC	Bearing and distance to waypoint-Great Circle
BWR	Bearing and distance to waypoint - Rhumb Line
DBT	Depth Below Transducer
DPT	Depth
DTM	Data Reference
GGA	Global Positioning System Fix Data
GLL	Geographic Position
GNS	GNSS Fix Data
GSA	GNSS DOP and Active Satellites
GSV	GNSS Satellites in View
HDG	Heading, Deviation & Variation
HDM	Heading, Magnetic
HDT	Heading True
MTW	Water Temperature
MWV	Wind Speed and Angle
RMB	Recommended Minimum Specific Navigation Information
RMC	Recommended Minimum Specific GNSS Data
THS	True Heading and Status
TTM	Tracked Target Message
VDM	AIS VHF Data-link Message
VHW	Water Speed and Heading
VTG	Course Over Ground & Ground Speed
VWR	Wind relative Bearing and Velocity
VWT	True Wind Speed and Angle
XTE	Cross-Track Error, Measured
ZDA	Time & Date
ALR	Set alarm state
BWC	Bearing and distance to waypoint - Great Circle
BWR	Bearing and distance to waypoint - Rhumb Line
DBT	Depth Below Transducer
DPT	Depth

NMEA3 (HDG) Input Sentence

Sentence	Description
HDG	Heading, Deviation & Variation
HDM	Heading, Magnetic
HDT	Heading True

1. INSTALLATION

Sentence	Description
THS	True Heading and Status
VHW	Water Speed and Heading

NMEA1/NMEA2 Output Sentence

Sentence	Description
ACK	Acknowledge Alarm
RSD	Radar System Data
TLL	Target Latitude and Longitude
TTM	Tracked Target Message

1.5 Initial Settings

1.5.1 How to select language

Language selection at initial start up

At the first power on after installation or whenever the memory is cleared, the language selection screen appears. Select your language as shown below. The default language is English.

1. Press the () key on the display unit to turn on the power. The splash screen appears followed by the language selection screen.

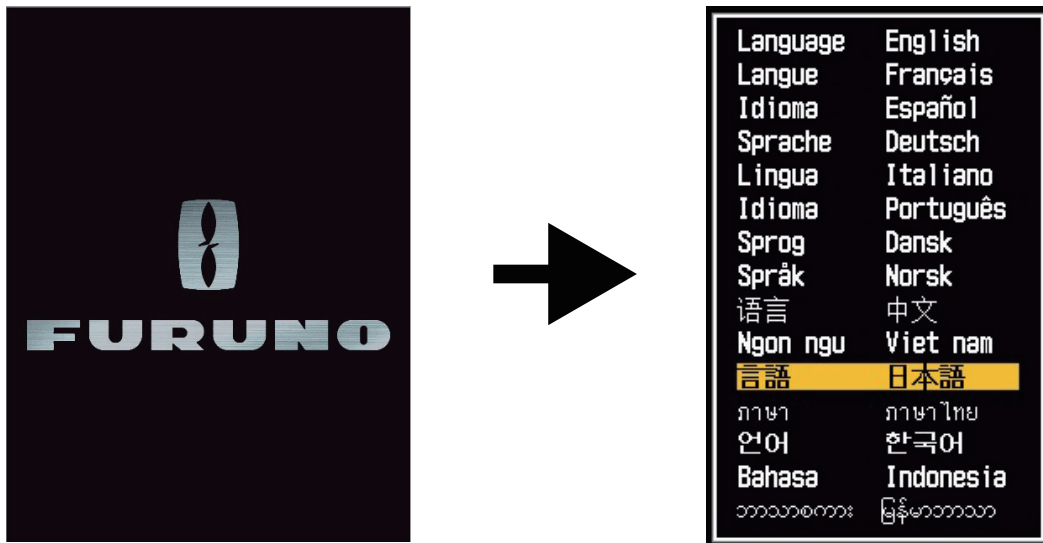

2. Operate the Cursorpad (▲ or ▼) to select the language of your choice then press the **ENTER** key.

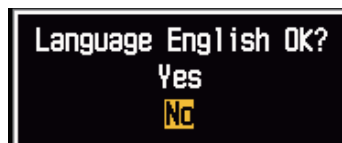

3. Push ▲ on the Cursorpad to select [Yes] then press the **ENTER** key.
4. Press the **MENU/ESC** key to close the menu.

Language selection from the menu

1. Press the () key on the display unit to turn on the power.
2. Press the **MENU/ESC** key to show the menu.
3. Do the following to access the [Factory] menu.
 - 1) Select [Factory], then press the **ENTER** key.
 - 2) While pressing and holding the **MENU/ESC** key, press the **ALARM** key five times to unlock the [Installation] menu.

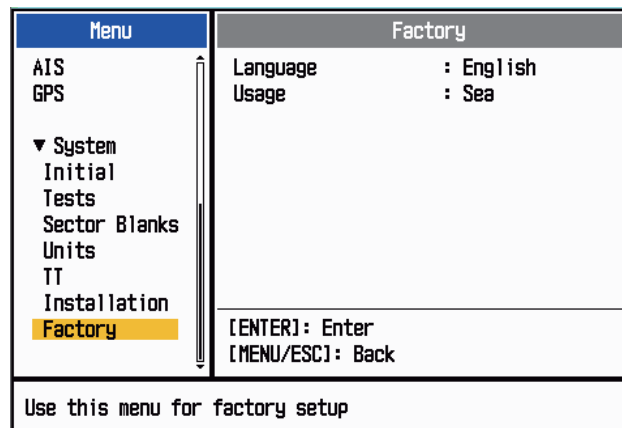

4. Select [Language], then press the **ENTER** key.



5. Select your language, then press the **ENTER** key.
6. Press the **MENU/ESC** key to close the menu.

1.5.2 How to select radar application

The radar application setting automatically changes the unit of range measurement and other settings.

1. Press the **MENU/ESC** key to show the menu.
2. Do the following to access the [Factory] menu.
 - 1) Select [Factory], then press the **ENTER** key.
 - 2) While pressing and holding the **MENU/ESC** key, press the **ALARM** key five times to unlock the [Installation] menu.

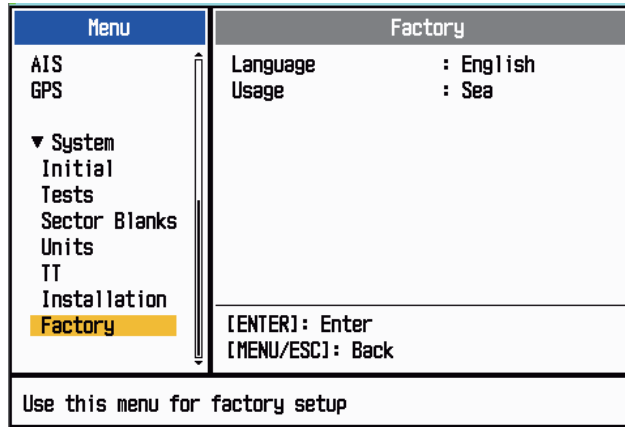

3. Select [Usage], then press the **ENTER** key.
4. Select [River] or [Sea] as appropriate, then press the **ENTER** key.
5. Press the **MENU/ESC** key to close the menu.



1.5.3 Initial settings

1. Press the **MENU/ESC** key to show the menu.
2. Select [Installation], then press the **ENTER** key.

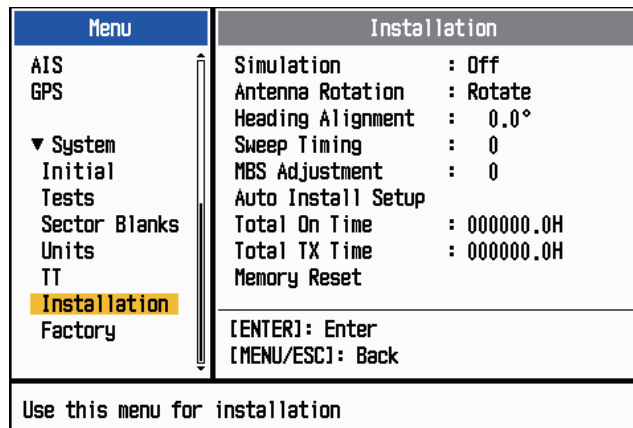

3. While pressing and holding the **MENU/ESC** key, press the **ALARM** key five times to unlock the [Installation] menu.
4. Select the item to set, then press the **ENTER** key.
5. Select the option required, then press the **ENTER** key.
6. After setting all items, press the **MENU/ESC** key to close the menu.

Item description

- **[Simulation]:** Normally, set to [Off.] To view the demonstration picture, select [On].
- **[Antenna Rotation]:** Select [Rotate] to rotate the antenna and transmit radar pulses. The [Stop] setting, which transmits radar pulses without rotating the antenna, is for use by the service technician.
- **[Heading Alignment]:** You have installed the antenna unit so that the unit faces toward the bow. A target at the front of the boat and aligned with the bow must appear on the heading line (zero degrees). If the target does not appear on the heading line, do the procedure shown below to adjust the heading.
 1. Set ship heading toward an acceptable target (for example, ship at anchor or buoy) at a range between 0.125 and 0.25 nautical mile.
 2. Transmit the radar at the range of 0.25 nautical mile and measure the bearing of that target relative to ship heading with an EBL.
 3. Open the [Installation] menu and select [Heading Adjust].
 4. Press the **ENTER** key to show the heading adjustment window.
 5. Press **▲** or **▼** to set the value measured at the above step 2. Check that the target appears on the heading line.
 6. Press the **ENTER** key to finish.
- **[Sweep Timing]:** This adjustment gives correct radar performance on short ranges. The radar measures the time required for a transmitted echo to go to the target and return to the source. The received echo appears on the display according to the measured time. The sweep must start from the center of the display. A trigger pulse created in the display unit goes to the antenna unit through the signal cable to activate the transmitter (magnetron). The time taken by the signal to move to the antenna unit changes, according to the length of the signal cable. During this period, the display unit must wait before the radar starts the sweep. When the display unit is not adjusted correctly, the echoes from a straight object will not appear as a straight line. The target appears "pushed" or "pulled" near the picture center. The range to objects are shown at wrong distances.

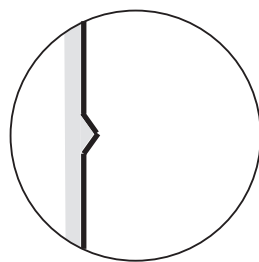

(1) Target pulled

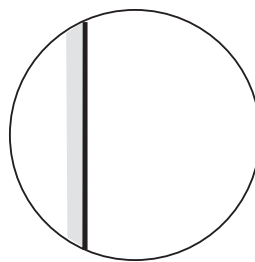

(2) Correct

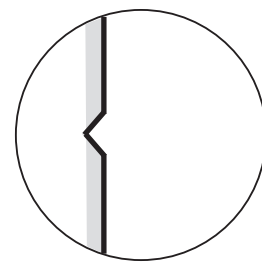

(3) Target pushed outward

1. Transmit on the shortest range, then adjust the gain and the A/C SEA.
2. Visibly select a target that creates a straight line (harbor wall, straight piers).
3. Open the [Installation] menu and select [Timing Adjust].
4. Press the **ENTER** key to show the timing adjustment window.
5. Press **▲** or **▼** to make straight the target selected at step 2, then press the **ENTER** key to finish.

1. INSTALLATION

- **[Main Bang Suppression]**: Reduce the main bang (black hole at center of screen), which appears at the display center on short ranges, as follows.
 1. Open the [Installation] menu and select [MBS Adjust].
 2. Press the **ENTER** key to show the MBS adjustment window.
 3. Press **▲** or **▼** on the Cursorpad so that the main bang is reduced.
 4. Press the **ENTER** key to finish.
- **How to automatically set the equipment**: The tuning, timing, and video can be automatically adjusted as follows.

Note: Before doing this procedure, transmit the radar more than 10 minutes on a long range and check that [Sector Blank] is [Off].

 1. Transmit on the maximum range.
 2. Open the [Installation] menu and select [Auto Initial Setup], then press the **ENTER** key.
 3. Press **▲** on the Cursorpad to select [Yes], then press the **ENTER** key.

The tuning adjustment begins automatically, and the message "Tuning adjusting" appears during tuning adjustment. After the tuning adjustment is completed, the timing and video are adjusted in that order, showing appropriate status messages. After all adjustments are completed, the window disappears. If the result for any item is not best for your conditions, manually adjust the item according to the procedure in this section.
- **[Total On Time]**: You can set the total on time as shown below.
 1. Open the [Installation] menu and select [Total On Time].
 2. Press the **ENTER** key.
 3. Press **▲** or **▼** on the Cursorpad to set value. The range is 000000.H to 999999.9 H.
 4. Press the **ENTER** key to finish.
- **[Total TX Time]**: You can set the total TX time as shown below.
 1. Open the [Installation] menu and select [Total TX Time].
 2. Press the **ENTER** key.
 3. Press **▲** or **▼** on the Cursorpad to set value. The range is 000000.H to 999999.9 H.
 4. Press the **ENTER** key to finish.
- **[Memory Clear]**: The memory clear feature restores all settings to default, including the default settings for the antenna connected to LAN.
 1. Open the [Installation] menu and select [Memory Clear].
 2. Press the **ENTER** key.
 3. Press **▲** or **▼** on the Cursorpad to select [Yes], then press the **ENTER** key.
 4. Press the **ENTER** key to finish.

1.6 Optional Equipment

1.6.1 External buzzer

The external buzzer alerts you to violation of the guard zone in a remote location. Connect the buzzer to the display unit as shown below, using the external buzzer installation kit.

External Buzzer Installation Kit

Type: OP03-31, Code No.: 000-030-097

	Name	Type	Code No.	Qty	Remarks
1	Buzzer	PKB42SWH2940	000-153-221-10	1	Connector at both ends
2	Cable Tie	CV-70N	000-162-185-10	5	
3	Heat Shrink Tube	3×0.25 BLK	—	1	
4	Double-sided Tape	25×25×T0.91MM	000-173-188-10	1	25 m×25 mm

As shown in the illustration below, cut the connector from the end of the cables. Fabricate the cables as shown, then connect the cables to the terminal board (local supply).

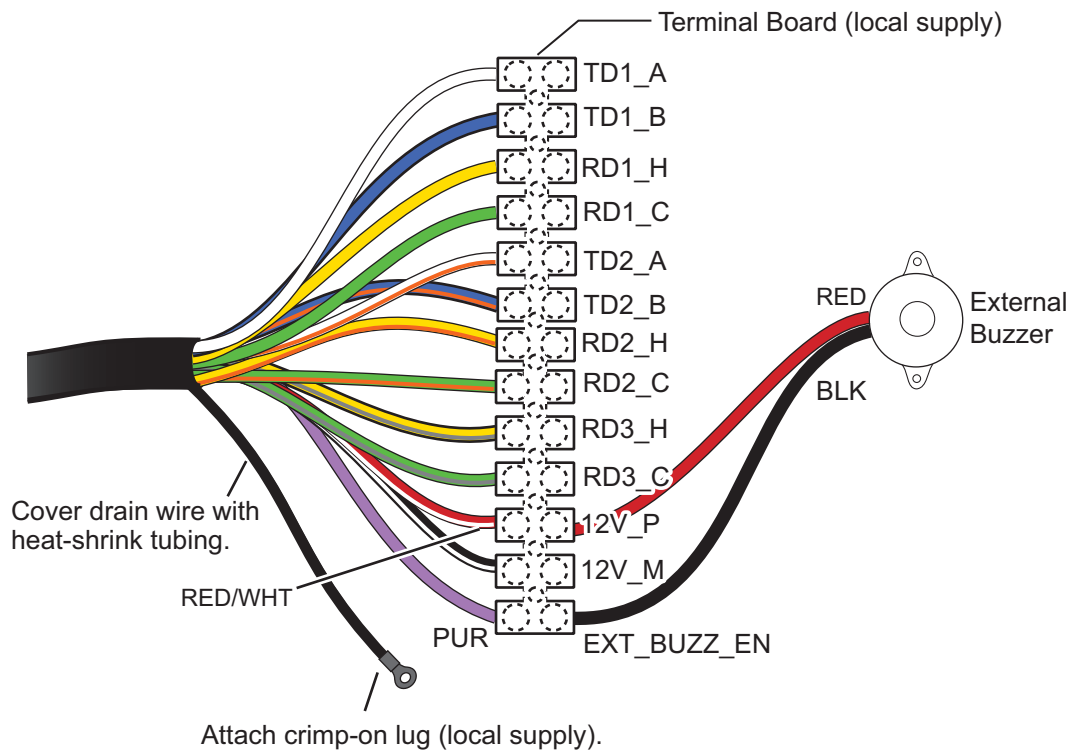

1. INSTALLATION



This page is intentionally left blank.

2. OPERATION

2.1 Controls

Display unit

The display unit has six keys, two knob controls and a Cursorpad that control the radar. When you correctly do an operation, the unit beeps once. If the operation is incorrect, the unit beeps three times.

	Control	Description
	MENU/ESC	<ul style="list-style-type: none"> • Open/close the menu. • Cancel selection (setting).
	Cursorpad	<ul style="list-style-type: none"> • Select menu items and options. • Move the cursor.
	ENTER	<ul style="list-style-type: none"> • Save selected menu option. • Acquire target to track its movement. • Select TT or AIS target to display its data.
	MODE	Show the [Mode] window to access various functions.
	ALARM	Set the target alarm, which checks for targets in the area you select.
	FUNC	Do the function assigned to this key.
	RANGE (PUSH FOR GAIN)	Rotate: Select the detection range. Push: Show the window for adjustment of gain, sea clutter, and rain clutter.
	DATA BOX	Select the data box to display (at the bottom of the screen).
		Short push: <ul style="list-style-type: none"> • Turn on the power. • Adjust the brilliance of the display and the control panel. • Switch the radar between standby and TX. Long push: Turn off the power.

2.2 How to Turn the Radar On/Off

Press the  key to turn on the radar. To turn off the radar, press and hold down the key until the screen turns off.



When you turn on the power, the initialization screen appears followed by the splash screen. The ROM and RAM are tested and if those are normal, the standby screen appears approx. 5 sec. later, and the time remaining for magnetron warm-up (approx. 90 seconds) is counted down on the screen. **If the ROM and RAM test result shows NG (No Good), contact your dealer for instruction.**

2.3 TX/Standby

After the magnetron has warmed, the indication [ST-BY] appears at the screen center. The radar is now ready to transmit radar pulses. The standby screen is available in two types, normal and nav (navigation data). See section 2.37.

To switch between TX and standby, push the  key to show the [Brill/Panel] window.

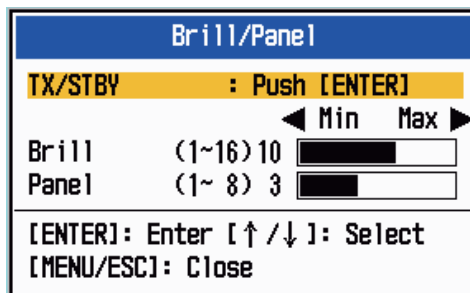

The cursor is selecting [TX/STBY]. Press the **ENTER** key to transmit the radar pulses and put the radar in standby alternately. The antenna rotates in transmit and is stopped in standby. Because the magnetron ages with use, set the radar in stand-by when you are not using the radar, to extend the life of the magnetron.

Note: The display unit supplies “standby power” to the antenna unit when the display unit is turned off. If use of the radar is not required for an extended period, shut off the radar at the breaker. The antenna unit’s current consumption with the display unit turned off is 0.8A for 12 VDC and 0.4A for 24 VDC.

2.4 Display Indications

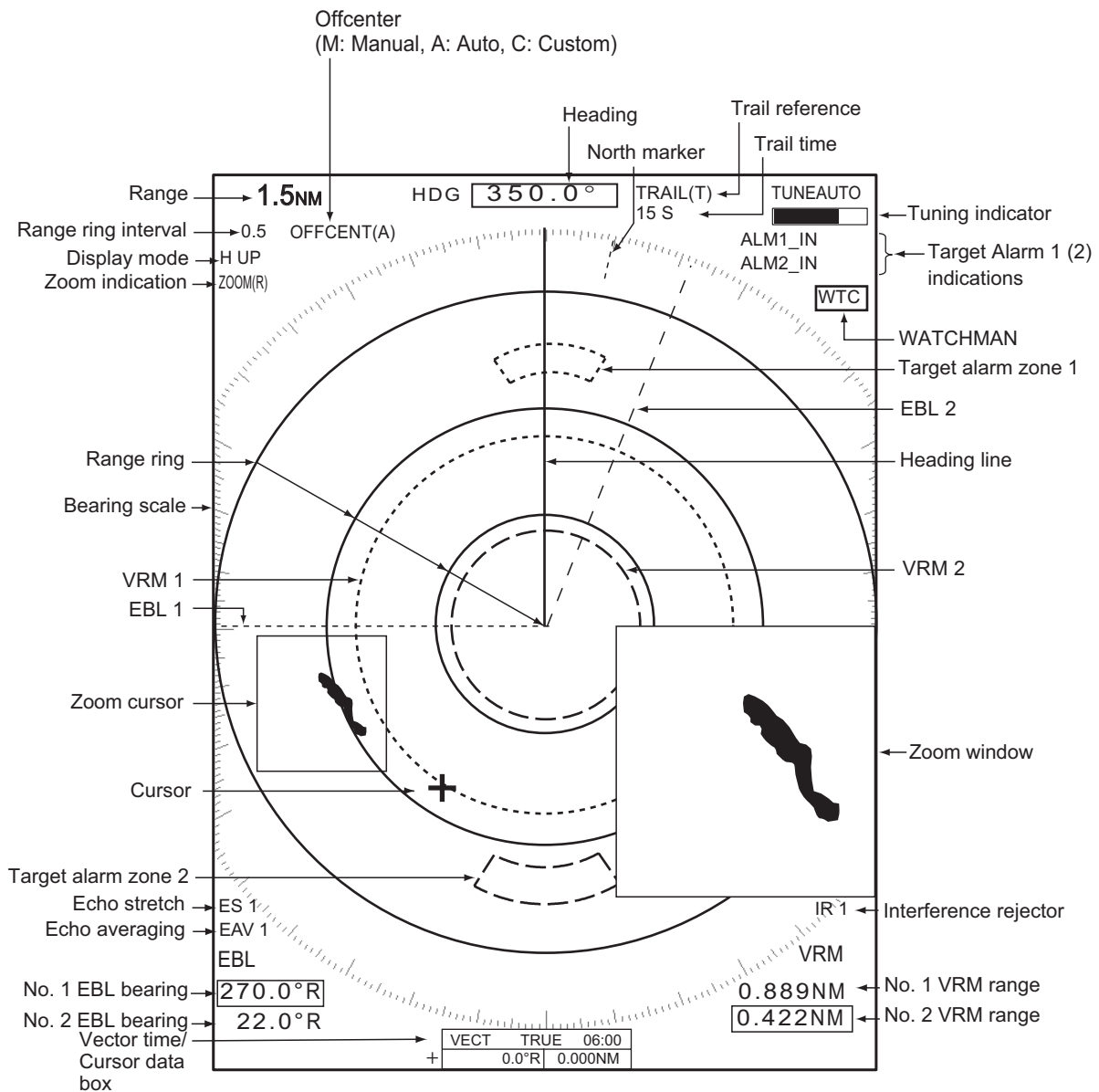

NAV data box

Various navigation data can be shown below the Vector time/Cursor data box. Use the **DATA BOX** knob to select a data display. The example below shows nav data (NAV position on **DATA BOX** knob).

OWN SHIP		+ CURSOR		WAYPOINT	
LAT	34°56.123N	LAT	34°56.123N	BRG	14.8°
LON	135°34.567E	LON	135°34.567E	RNG	0.876NM
SPEED	12.3KN	TTG	00:00	TTG	00:00

2.5 How to Adjust Display Brilliance, Panel Dimmer

You can adjust the display brilliance and panel dimmer as follows:

1. Press the  key to show the [Brill/Panel] window.

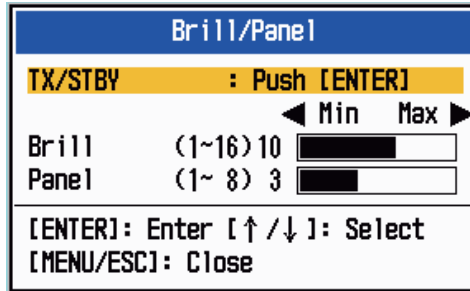

2. Use the Cursorpad to select [Brill] or [Panel] as required.
3. Use the Cursorpad to adjust. (For brilliance, you can also use the  key.)
4. Press the **MENU/ESC** key to close the window.

2.6 Menu Description

This MODEL 1815 series has 14 menus and 7 sub menus. Below is the basic procedure for menu operation.

1. Press the **MENU/ESC** key to open the menu.

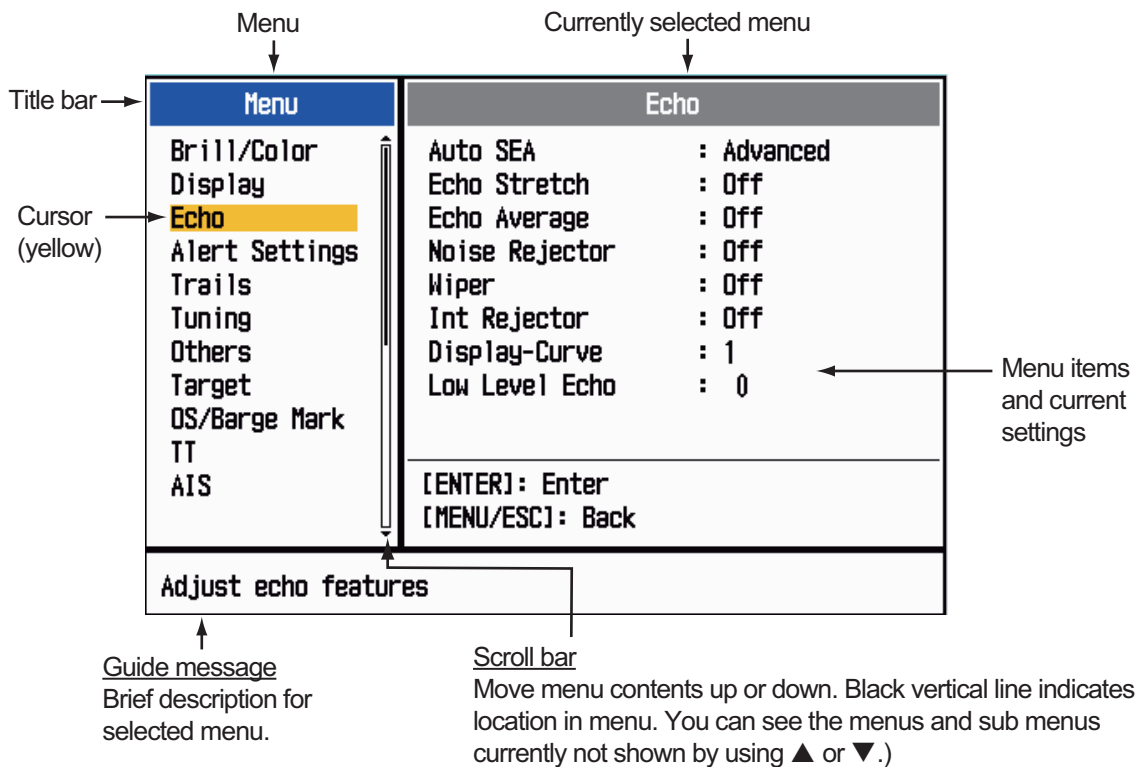

- Select a menu or a sub menu. The cursor (yellow) in the Menu column highlights the menu currently selected. The menu items in the right window change according to the menu selected.

Menu description

[**Brill/Color**]: Adjust the brilliance and color.

[**Display**]: Set up the display-related features.

[**Echo**]: Adjust the echo features.

[**Alert Settings**]: Customize the user settings.

[**Trails**]: Process trails of the radar targets.

[**Tuning**]: Adjust the radar tuning.

[**Others**]: Set up other items.

[**Target**]: Set up the targets configuration.

[**OS/Barge Mark**]: Set up the own ship mark and barge mark.

[**TT**]: Set up the TT (Target Tracking).

[**AIS**]: Set up the AIS.

[**GPS**]: Set up GP-320B (Black-Box GPS).

[**System**]:

- [**Initial**]: Initial settings.

- [**Tests**]: System diagnostic and LCD test.

- [**Sector Blanks**]: Prevent the transmission in a certain area.

- [**Units**]: Set up units of measurement.

- [**TT**]: Set up TT system. For the installer. Do not change the settings.

- [**Installation**] and [**Factory**]: For installation.

- Press the **ENTER** key to switch the control to the menu items column. The cursor in the menu column now turns gray and the cursor in the menu items column is yellow.

To switch control from the menu items column to the menu column, use the **MENU/ESC** key. The color of the title bar of the active column is blue and the inactive column is gray.

- Select a menu item, then press the **ENTER** key. A window with options for the related menu item appears.



Display Color options

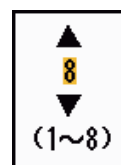

Echo Brill setting window

- Use **▲** or **▼** on the Cursorpad to select an option or set a numeric value.
- Press the **ENTER** key to save your selection. To close the window without saving, press the **MENU/ESC** key.
- Press the **MENU/ESC** key to close the menu.

2.7 Tuning

In default, the radar receiver can be tuned automatically after turning the radar to TX. If you require fine tuning in manual, do the following:

1. Set the radar in transmit state, then select the maximum range with the **RANGE** knob.
2. Press the **MENU/ESC** key to open the menu.
3. Select [Tuning], then press the **ENTER** key.

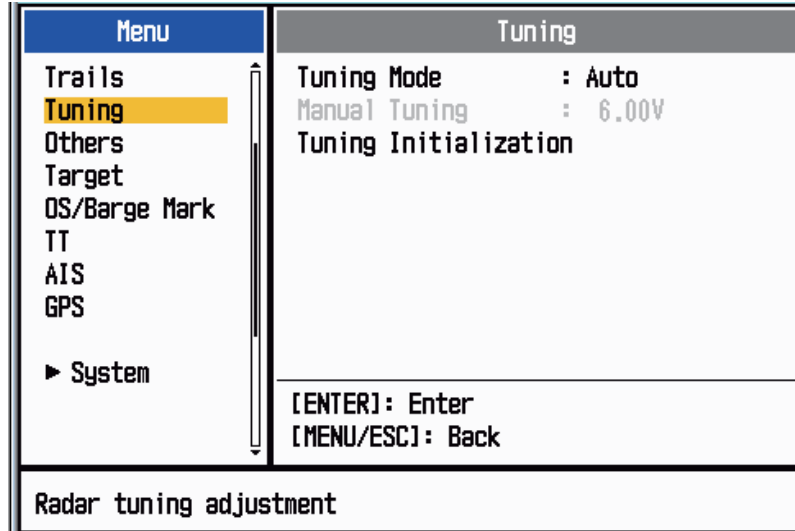

4. Select [Tuning Mode], then press the **ENTER** key.
5. Select [Manual], then press the **ENTER** key.
6. Select [Manual Tuning], then press the **ENTER** key to show the manual tuning setting window.

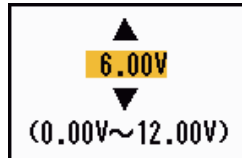

7. Use the Cursorpad to adjust the tuning while you look at the tuning bar at the upper-right corner of the display. The best tuning point is where the tuning bar moves to maximum value. The vertical bar on the tuning bar shows the tuning voltage.
8. Press the **ENTER** key.
9. Press the **MENU/ESC** key to close the menu.

Note: If the automatic tuning does not give the correct tuning, run the [Tuning Initialization] again.

2.8 Display Modes

This radar has the display modes shown below. All modes except head up require a heading signal. The true motion mode additionally requires position data.

Relative Motion (RM) displays

- [Head Up] ([H UP]): Heading is at the top of the screen.
- [Course Up] ([C UP]): The heading line positions to the course bearing at the moment the course up mode is selected. The bearing scale rotates accordingly.
- [North Up] ([N UP]): North is the reference direction; bearing scale is fixed.
- [True View]: Ship's bow is at the top of the screen. The picture is redrawn in real time.

True Motion (TM) displays

- [True Motion] (TM)

2.8.1 How to select the display mode

1. Press the **MENU/ESC** key to open the menu.
2. Select [Display], then press the **ENTER** key.

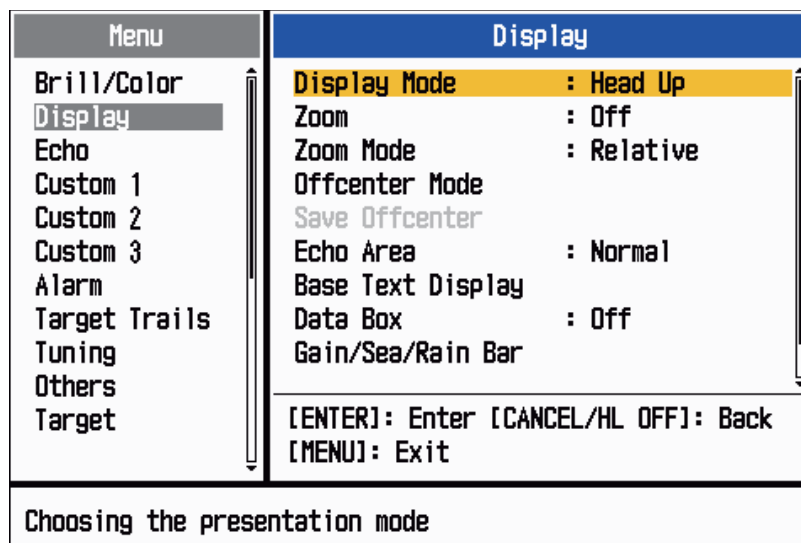

3. Select [Display Mode], then press the **ENTER** key.

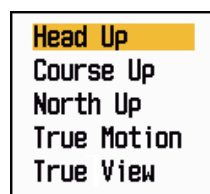

4. Select a display mode, then press the **ENTER** key.
5. Press the **MENU/ESC** key to close the menu.

Note 1: The display mode is automatically switched to head up if the heading signal becomes lost.

Note 2: All modes except head up require a heading signal in AD-10 format or NMEA format. If the heading signal is lost, the mode is changed to head up and the north

2. OPERATION

mark disappears. The display for heading is XXX.X and the alarm sounds. The message "GYRO" (AD-10 format data) or "NMEA_HDG" (NMEA format data) appears in the alarm message display. To stop the audio alarm, press any key. When the heading signal is restored, check the heading. The numeric value is displayed at the heading indication when the heading signal is restored.

2.8.2 Description of display modes

Head up mode

A display without azimuth stabilization in which the line that connects the center with the top of the display indicates your heading. Targets are shown at their measured distances and their directions relative to your heading. The short dotted line on the bearing scale is the north mark.

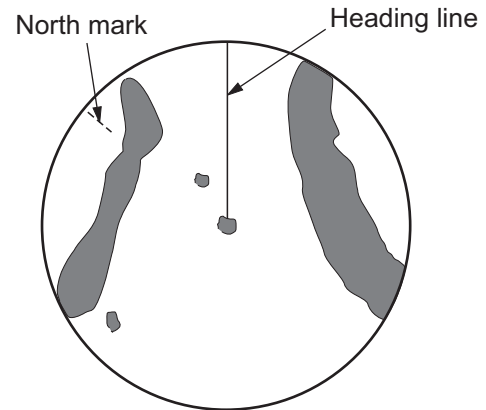

Course up mode

The radar picture is stabilized and displayed with the currently selected course at the top of the screen. When you change the heading, the heading line moves with the course selected. If you select a new course, select the course up mode again to display the new course at the top of the display.

Targets are shown at their measured distances and their directions relative to the set course, which is at the 0-degree position.

The heading line moves according to the yawing and any course change.

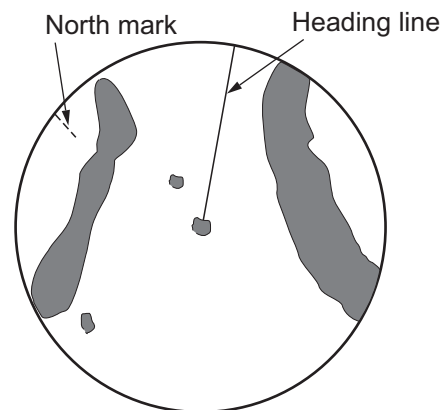

North up mode

Targets are shown at their measured distances and their true (compass) directions from your ship. North is at the top of the screen. The heading line changes its direction according to your heading.

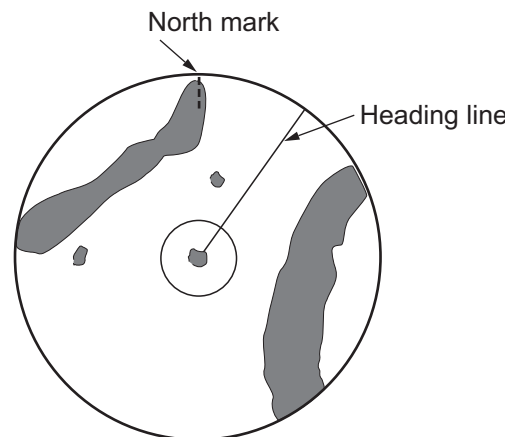

True motion mode

Your ship and other objects in motion move with their true courses and speed. All fixed targets, like landmasses, appear as fixed echoes in ground stabilized TM.

When your ship reaches a point that is 75% of the radius of the display, the position is reset. The ship appears at 75% radius opposite to the extension of the heading line on the display center. You can manually reset your ship symbol with the off-center feature.

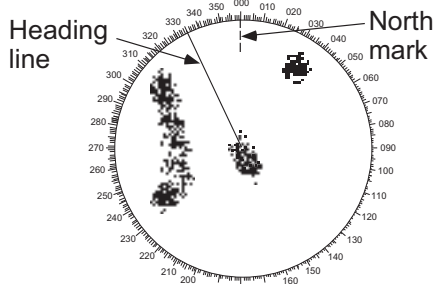
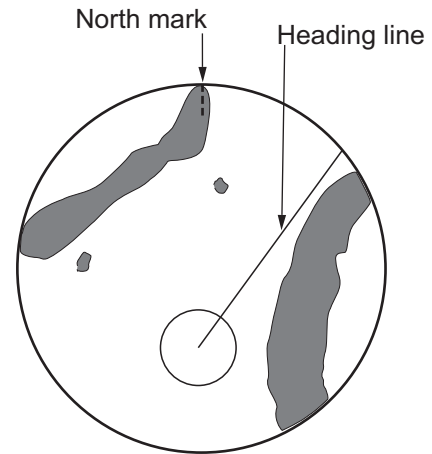

(a) True motion is selected

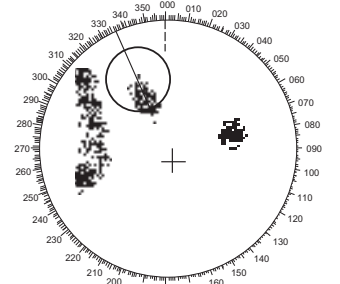

(b) Your ship has reached a point 75% of display radius

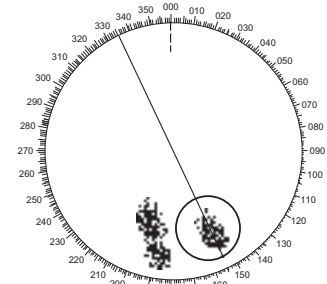

(c) Your ship is automatically reset to 75% of display radius

True view mode

The echoes move in real time depending on the change of the heading of your ship. Heading line is at the top of the screen. When the heading signal is lost, this function is not available and the display mode automatically changes to the head up mode. The [Wiper] is not available in this mode.

Note: The wiper feature is inoperative when the true view mode is in use.

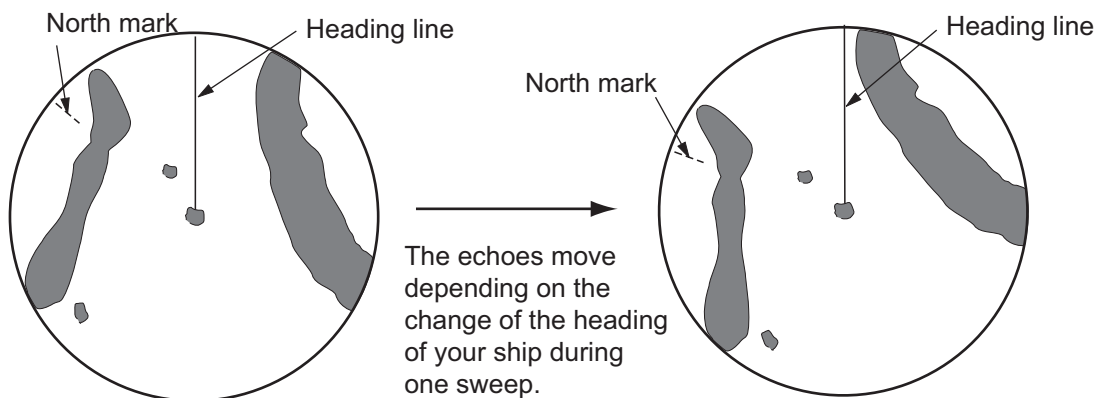

2.9 How to Select the Range Scale

The selected range scale, range ring interval and pulse length are shown at the top left corner on the screen. When an objective target comes closer, reduce the range scale so that a target appears in 50-90% of the display radius.

Rotate the **RANGE** knob to select range, clockwise (+ side) to enlarge the target, or counterclockwise (- side) to shrink the target.

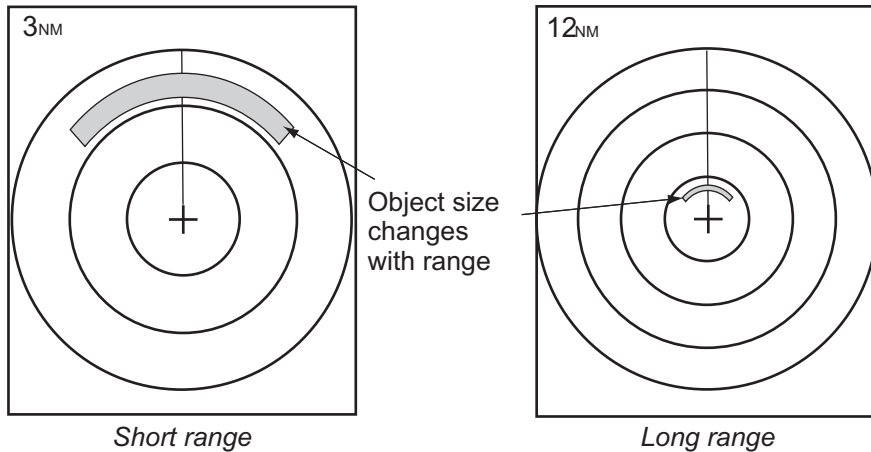

2.10 How to Adjust the Gain (sensitivity)

The gain control adjusts the sensitivity of the receiver for the best reception. The gain can be adjusted automatically or manually.

1. Push the **RANGE** knob to show the [GAIN/SEA/RAIN] window. (This window closes if there is no operation within 10 seconds.)

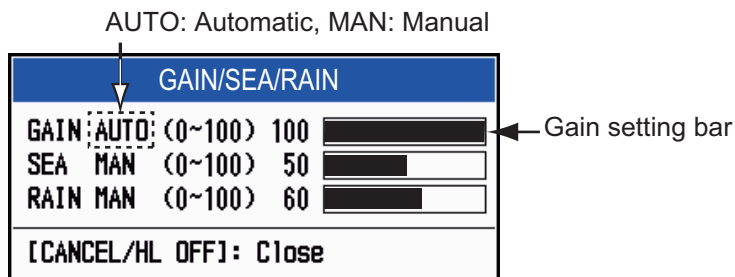

2. The cursor is selecting [GAIN]. Press the **ENTER** key to show [GAIN AUTO] or [GAIN MAN] as required. For manual adjustment, see the section below.
3. Press the **MENU/ESC** key to close the window.

Manual adjustment of gain

1. Rotate the **RANGE** knob (or use ◀ or ▶ on the Cursorpad) to adjust the gain so that weak noise appears on all of the screen. If the gain is too low, weak echoes are erased. If the gain is too high, the background noise hides weak targets.
2. Press the **MENU/ESC** key to close the window.

2.11 How to Reduce the Sea Clutter

The reflected echoes from the waves appear around your ship and have the name "sea clutter". The sea clutter extends according to the height of waves and antenna above the water. When the sea clutter hides the targets, use the sea clutter function to reduce the clutter, either manually or automatically.

How to select the sea clutter adjustment method

1. Press the **RANGE** knob to show the [GAIN/SEA/RAIN] window. (This window closes if there is no operation within 10 seconds.)

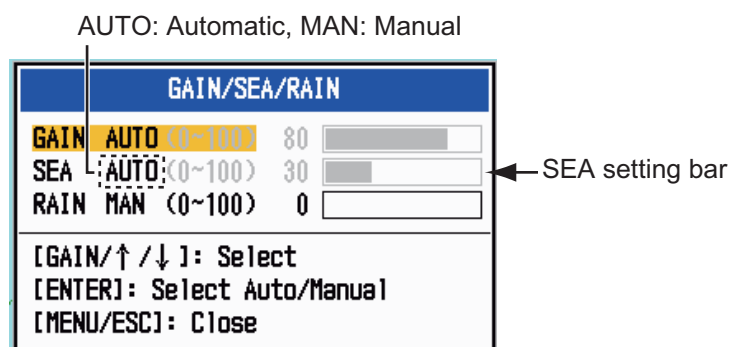

2. Select [SEA]. Press the **ENTER** key to show [SEA AUTO] or [SEA MAN] as required. For manual adjustment, see the section below.
3. Press the **MENU/ESC** key to close the window.

Manual adjustment of sea clutter

1. Rotate the **RANGE** knob (or use ◀ or ▶ on the Cursorpad) to adjust the sea clutter.

Note: When the sea clutter is properly adjusted, the clutter is broken into small dots, and small targets become identified. If the setting is not enough, targets are hidden in the clutter. If the setting is higher than necessary, both sea clutter and targets disappear from the display. Normally adjust the knob until the clutter has disappeared to leeward, but a small amount of the clutter is visible windward.

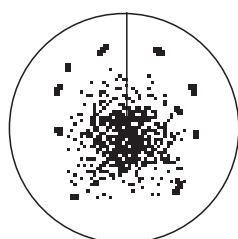

Sea clutter at screen center

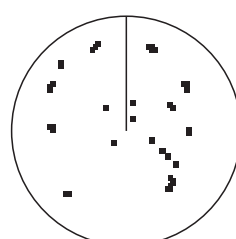

SEA control adjusted; sea clutter reduced

2. Press the **MENU/ESC** key to close the window.

How to select the automatic sea clutter adjustment method

The automatic sea clutter adjustment is available in two types for optimal automatic adjustment according to the situation. Select the required method as shown below.

1. Press the **MENU/ESC** key to open the menu.
2. Select [Echo], then press the **ENTER** key.

2. OPERATION

3. Select [Auto SEA], then press the **ENTER** key.
4. Select [Coastal] or [Advanced] then press the **ENTER** key. The window for GAIN/SEA/RAIN indicator appears for confirmation.
[Advanced]: Discriminate land echoes from sea reflections to suppress only sea reflections. The degree of sea clutter reduction is smaller than [Coastal]. Use this mode for general use.
[Coastal]: Suppress both land and sea clutter. Useful when cruising along a coastline.
5. Press the **MENU/ESC** key to close the window.
6. Press the **MENU/ESC** key to close the menu.



2.12 How to Reduce the Rain Clutter

The reflections from the rain or snow appear on the screen. These reflections have the name "rain clutter". When the rain clutter is strong, targets in the rain clutter are hidden in the clutter. Reflections from the rain clutter are easily identified from true targets by their wool-like appearance.

The rain clutter function works like the sea clutter function, adjusting the receiver sensitivity, but in longer range. If the setting is high, the rain clutter is more reduced. The rain control breaks the continuous display of rain or snow reflections into a random pattern. When the rain clutter hides the targets, adjust the rain clutter (automatic or manual) to reduce the clutter.

How to select the rain clutter adjustment method

1. Push the **RANGE** knob to show the [GAIN/SEA/RAIN] window. (This window closes if there is no operation within 10 seconds.)

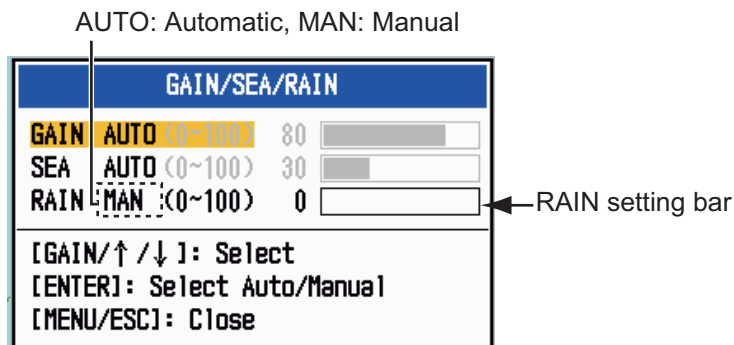

2. Select [RAIN]. Press the **ENTER** key to show [RAIN AUTO] or [RAIN MAN] as required. For manual adjustment, see the section below.
3. Press the **MENU/ESC** key to close the window.

Manual adjustment of rain clutter

1. Rotate the **RANGE** knob (or use ◀ or ▶ on the Cursorpad) to adjust the rain clutter.
2. Press the **MENU/ESC** key to close the window.

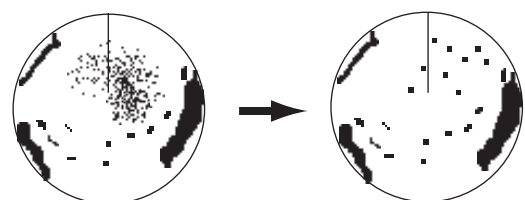

Rain clutter near center of screen

RAIN control adjusted; rain clutter reduced

2.13 Cursor

The cursor functions to find the range and bearing (default function) to a target or the latitude and longitude position of a target. Use the Cursorpad to position the cursor and read the cursor data at the screen bottom.

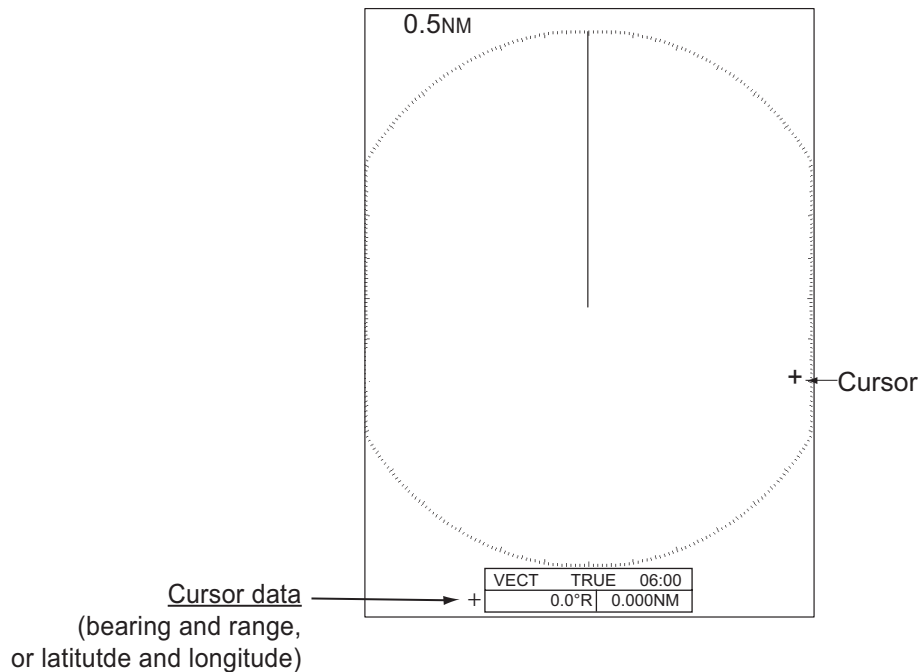

How to select cursor data type

You can show the cursor data as range and bearing (from your ship to the cursor) or latitude and longitude. Position and heading signal are required.

1. Press the **MENU/ESC** key to open the menu.
2. Select [Others], then press the **ENTER** key.

Menu	Others
Brill/Color	F1 Setup : Gain Mode
Display	F2 Setup : Sea Mode
Echo	F3 Setup : A/C Auto
Custom 1	WPT Mark : Off
Custom 2	EBL Reference : Relative
Custom 3	VRM Unit : NM
Alarm	Cursor Position : Rng/Brg
Target Trails	
Tuning	
Others	
Target	
[ENTER]: Enter [CANCEL/HL OFF]: Back [MENU]: Exit	
Choosing the function assigned to [F1]	

3. Select [Cursor Data], then press the **ENTER** key.
4. Select [RNG/BRG] or [LAT/LON] then press the **ENTER** key.
(When the navigation data is displayed, cursor latitude and longitude position cannot be displayed.)
5. Press the **MENU/ESC** key to close the menu.

RNG/BRG
LAT/LON

2.14 How to Temporarily Erase the Heading Line

The heading line is a line from your ship position to the outer edge of the radar display area, and indicates the heading of your ship in all display modes. The heading line appears at zero degrees on the bearing scale in head up and true view modes. The heading line changes the orientation depending on the ship orientation in north up and true motion modes and when the course is changed in the course up mode.

In some cases, the heading line may hide a object. To erase the heading line to view an object hidden by the line, press the **MENU/ESC** key. The heading line and the range rings are temporarily erased. Release the key to redisplay the line and rings.

2.15 Interference Rejector

Radar interference can occur when your ship is near the radar of another ship that operates on the same frequency band with your radar. The interference shows on the screen as many bright dots. The dots can be random or in the shape of dotted lines that run from the center to the edge of the display. You can identify the interference from the normal echoes, because the interference does not appear in the same location at the next antenna rotation. When this feature is turned on, "IR 1", "IR 2" or "IR 3" appears at the lower-right corner.

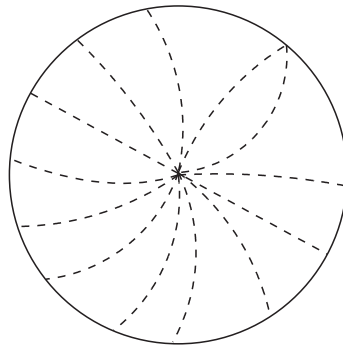

1. Press the **MENU/ESC** key to open the menu.
2. Select [Echo], then press the **ENTER** key.
3. Select [Int Rejector], then press the **ENTER** key.
4. Select [Off] or [On] then press the **ENTER** key.
5. Press the **MENU/ESC** key to close the menu.



Note: When there is no interference, turn off the interference rejector so you do not miss the small targets.

2.16 Noise Rejector

White noise can appear on the screen as random "marks". You can reduce this noise as follows:

1. Press the **MENU/ESC** key to open the menu.
2. Select [Echo], then press the **ENTER** key.
3. Select [Noise Rejector], then press the **ENTER** key.
4. Select [Off] or [On] then press the **ENTER** key.
5. Press the **MENU/ESC** key to close the menu.



2.17 How to Measure the Range to a Target

You can measure the range to a target in three methods. the fixed range rings, the cursor (if set to measure range and bearing), and the VRM (Variable Range Marker).

Use the fixed range rings to get a rough estimate of the range to a target. The fixed range rings are the concentric solid circles about your ship. The number of rings changes with the selected range scale. The interval of the range ring is displayed at the upper-left corner of the screen. Count the number of rings between the center of the display and the target. Check the range ring interval and measure the distance of the echo from the nearest ring.

2.17.1 How to adjust range ring brilliance

1. Press the **MENU/ESC** key to open the menu.
2. Select [Brill/Color], then press the **ENTER** key.

Menu	Brill/Color
Brill/Color	Echo Brill : 8
Display	Rings Brill : 4
Echo	Mark Brill : 4
Custom 1	HL Brill : 4
Custom 2	Character Brill : 4
Custom 3	View Position : Center
Alarm	Display Color : Custom
Target Trails	Echo Color : Yellow
Tuning	Background Color : Black
Others	
Target	
[ENTER]: Enter [CANCEL/HL OFF]: Back [MENU]: Exit	
Adjusting echo brilliance	

3. Select [Rings Brill], then press the **ENTER** key.
4. Select an option, then press the **ENTER** key. [4] is the brightest. [Off] turns off the range rings.
5. Press the **MENU/ESC** key to close the menu.

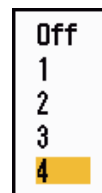

2.17.2 How to measure the range with a VRM

There are two VRMs, No. 1 and No. 2. The VRMs are dashed rings so that you can identify the rings from the fixed range rings. You can identify VRM 1 from VRM 2 by different lengths of dashes. The dashes of the No. 1 VRM are shorter than those of the No. 2 VRM.

1. Press the **MODE** key to show the [Mode] window.

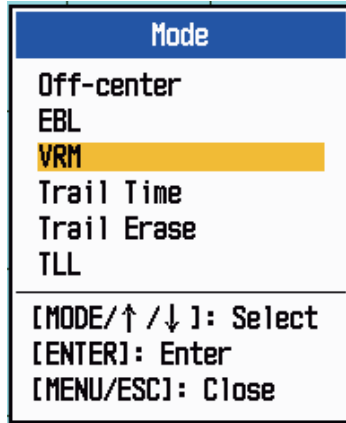

2. Select [VRM] then press the **ENTER** key.
3. Select [VRM 1] or [VRM 2] as required, then press the **ENTER** key. The corresponding VRM indication appears at the bottom right corner, inside a rectangle.
4. Use the Cursorpad to align the VRM with the inner edge of the target. Read the distance at the lower-right corner of the screen. The size of the VRM ring changes in proportion to the selected range scale.
5. To anchor the VRM, press the **ENTER** key. To reactivate the VRM, select it from the [Mode] window.
6. To erase a VRM, press the **MODE** key to open the [Mode] window, select [VRM], then select the VRM to erase. Press the **MENU/ESC** key to erase the VRM and its indication. (If a VRM's indication is already in a rectangle, simply press the **MENU/ESC** key to erase the VRM and its indication.)

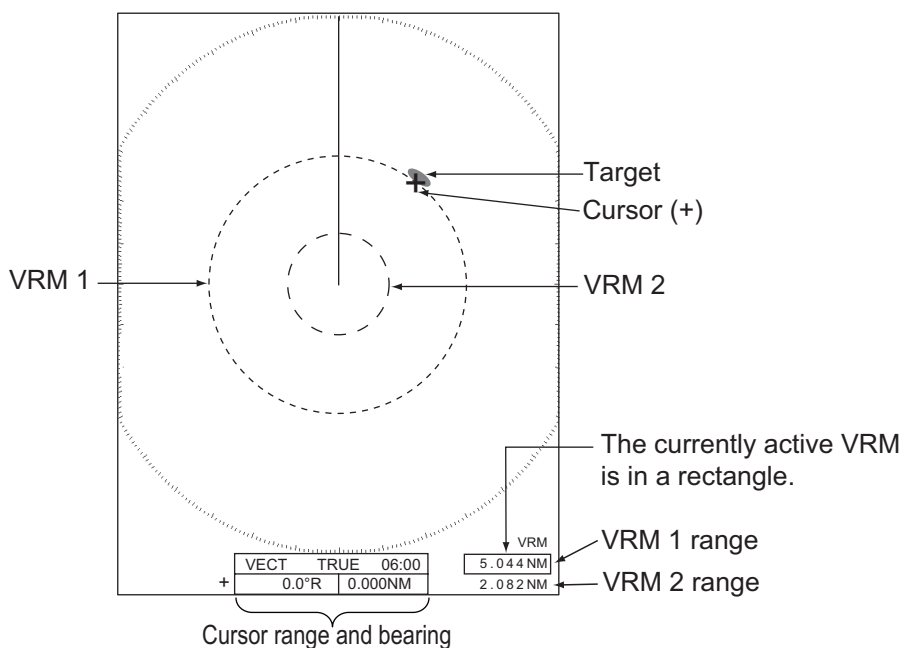

2.17.3 How to select VRM unit

You can select the unit of measurement used by the VRM. The selections are nautical miles (NM), kilometers (KM), statute miles (SM) or kiloyard (KYD). The cursor range unit is also changed when the VRM unit is changed.

1. Press the **MENU/ESC** key to open the menu.
2. Select [Others], then press the **ENTER** key.
3. Select [VRM Unit], then press the **ENTER** key.

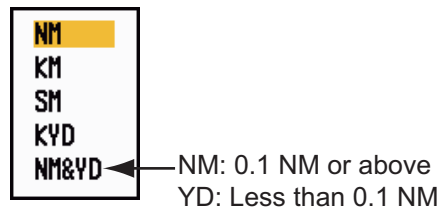

4. Select the unit, then press the **ENTER** key.
5. Press the **MENU/ESC** key to close the menu.

2.18 How to Measure the Bearing to a Target

Use the Electronic Bearing Line (EBL) to take a bearing of a target. There are two EBLs, No. 1 and No. 2. Each EBL is a straight dashed line from the center of the screen to the edge. The dashes of the No. 1 EBL are shorter than those of the No. 2 EBL.

2.18.1 How to measure the bearing with an EBL

1. Press the **MODE** key to show the [Mode] window.
2. Select [EBL] then press the **ENTER** key.
3. Select [EBL 1] or [EBL 2] as required, then press the **ENTER** key. The EBL indication appears at the bottom left corner, inside a rectangle.
4. Use the Cursorpad to place the EBL through the center of the target. Read the distance at the bottom left corner of the screen. The cursor on the EBL provides an estimate of the range to a target.
5. To anchor the EBL, press the **ENTER** key. To re-activate the EBL, select it from the [Mode] window.

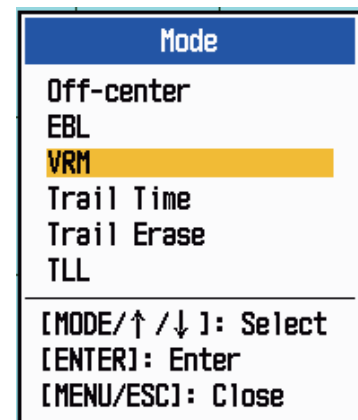

6. To erase a EBL, press the **MODE** key to open the [Mode] window, select [EBL], then select the EBL to erase. Press the **MENU/ESC** key to erase the EBL and its indication. (If a EBL's indication is already in a rectangle, simply press the **MENU/ESC** key to erase the EBL and its indication.)

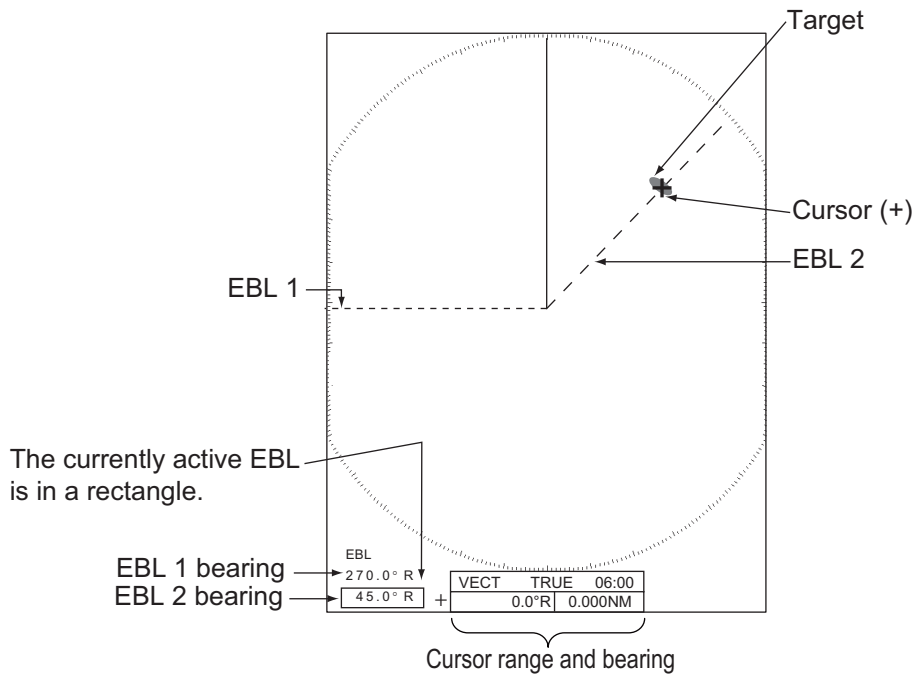

2.18.2 EBL reference

"R" (relative) follows the EBL indication if the bearing is relative to the heading of your ship. "T" (true) follows the EBL indication if the bearing is in reference to the north. You can select relative or true in the head up and true view modes. The bearing indication is true in all other modes. True bearing requires a heading sensor.

1. Press the **MENU/ESC** key to open the menu.
2. Select [Others], then press the **ENTER** key.
3. Select [EBL Reference], then press the **ENTER** key.

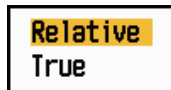

4. Select [Relative] or [True] then press the **ENTER** key.
5. Press the **MENU/ESC** key to close the menu.

2.19 How to Measure the Range and Bearing Between Two Targets

You can move the origin of the EBL to measure the range and bearing between two targets.

1. Press the **MODE** key.
2. Select [EBL], followed by [EBL 1], then press the **ENTER** key.
3. Use the Cursorpad to put the cursor on the center of the target A.
4. Press the **MODE** key, and the origin of the EBL moves to the cursor position.
5. Use the Cursorpad to put the cursor on the center of the target B, then press the **ENTER** key.
6. Press the **MODE** key, select [VRM] followed by [VRM 1], then press the **ENTER** key
7. Use the Cursorpad to set the VRM on the inner edge of the target B.
8. Read the bearing and range indications at the bottom of the screen.

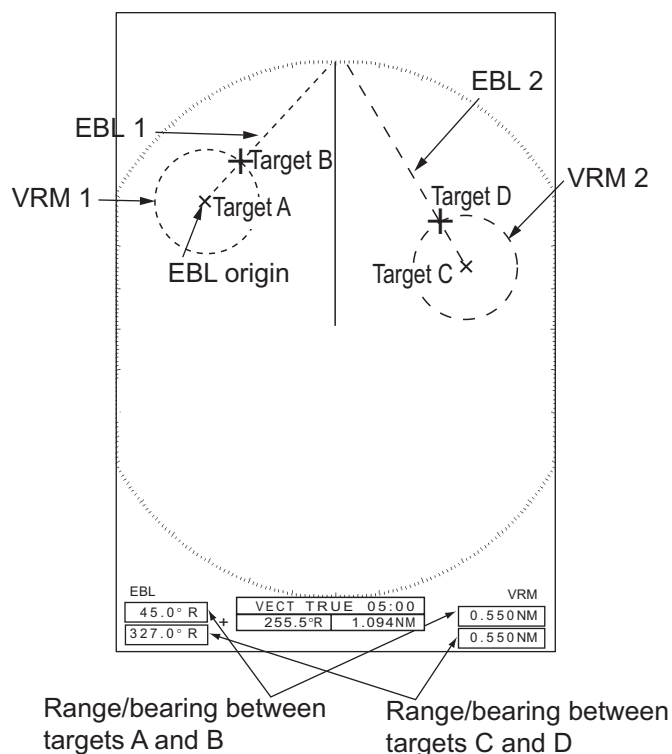

The range and bearing to another target (C and D in the figure above) can be measured using [EBL 2] and [VRM 2].

To cancel this function, turn off the EBL and VRM.

2.20 Target Alarm

The target alarm looks for targets (ship, landmass, etc.) in the area you set. Audiovisual alarms are released when a target enters (or exits) the alarm area.

 CAUTION
<ul style="list-style-type: none"> • Do not depend on the alarm as the only means to detect possible collision situations. • Adjust the A/C SEA, A/C RAIN and GAIN controls correctly so that the alarm system does not miss the target echoes.

2.20.1 How to set a target alarm zone

The following procedure shows you how to set a target alarm zone.

1. Press the **ALARM** key to activate ALARM 1 or ALARM 2. Press the **ALARM** key to change the active ALARM between No. 1 and No. 2. The indication of the currently active ALARM is in a rectangle at the upper-right corner of the screen.
2. Use the Cursorpad to move the cursor to the position A, then press the **ENTER** key.
3. Move the cursor to the position B, then press the **ENTER** key. The rectangle that shows alarm status indication at the upper-right corner of the screen disappears.

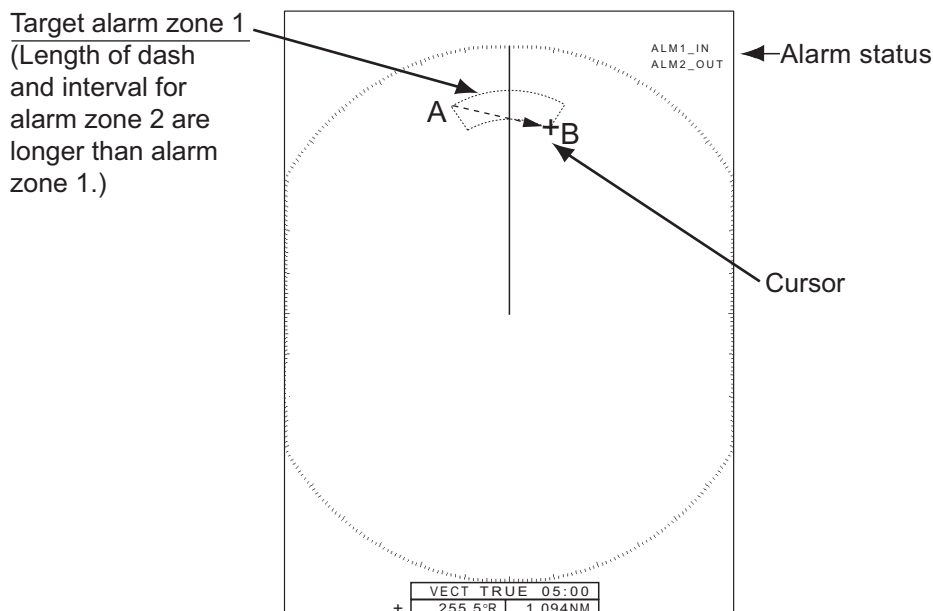

Note 1: To set a 360-degree guard zone, set the position B in the same bearing as the position A.

Note 2: When the target alarm zone is not within the range in use, the indication "ALM1(or 2)_RNG" replaces "ALM1(or 2)_IN(or OUT)" in the alarm status area. (When the target alarm zone is within the range of full off-centering, the indication does not change.) Select a range which displays the target alarm zone.

2.20.2 How to stop the audio alarm

When a target enters (or exits) the target alarm zone, the target flashes and the alarm sounds. The alarm message appears at the bottom of the screen. To stop the audio alarm, press any key. When the target enters (or exits) the target alarm zone again, the audio alarm sounds.

2.20.3 How to select the alarm type

You can set the target alarm to activate against targets entering or exiting the alarm zone.

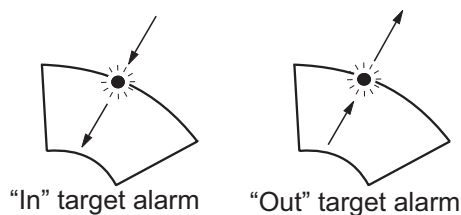

1. Press the **MENU/ESC** key to open the menu.
2. Select [Alert Settings], then press the **ENTER** key.

Menu	Alarm
Brill/Color	Target Alarm 1 : In
Display	Target Alarm 2 : In
Echo	Alarm Level : Med
Custom 1	Watchman : Off
Custom 2	Panel Buzzer : On
Custom 3	External Buzzer : On
Alarm	Alarm Status
Target Trails	
Tuning	
Others	
Target	
[ENTER]: Enter [CANCEL/HL OFF]: Back [MENU]: Exit	
Choosing the type (in/out) of target alarm 1	

3. Select [Target Alarm 1] or [Target Alarm 2] then press the **ENTER** key.
4. Select [In] or [Out].
 [In]: The alarm sounds against targets entering a target alarm zone.
 [Out]: The alarm sounds against targets exiting a target alarm zone.
5. Press the **ENTER** key followed by the **MENU/ESC** key.



2.20.4 How to sleep a target alarm temporarily

When you do not require a target alarm temporarily, you can sleep the target alarm. The alarm zone remains on the screen, but any targets that enter (or exit) the alarm zone do not trigger the audio and visual alarms.

1. Press the **ALARM** key to select the ALARM 1 or ALARM 2 indication at the upper-right corner on the screen. The selected indication is in a rectangle.
2. Press the **MENU/ESC** key. The alarm indication now shows "ALM1(or 2)_ACK".

To activate a sleeping target alarm zone, press the **ALARM** key to select the ALARM 1 or ALARM 2, then press the **ENTER** key. The alarm indication then changes to "ALM1(or 2)_IN(or OUT)".

2.20.5 How to deactivate a target alarm

1. Press the **ALARM** key to select the ALARM 1 or ALARM 2 indication at the upper-right corner on the screen. The selected indication is in a rectangle.
2. Press the **MENU/ESC** key. The alarm indication now shows "ALM1(or 2)_ACK".
3. Press the **ALARM** key. The alarm indication "ALM1(or 2)_ACK" is shown in a dashed-line rectangle.
4. Press the **MENU/ESC** key. The target alarm zone and the alarm indication are erased from the screen.

2.20.6 How to select the target strength which triggers a target alarm

You can select the target strength which triggers the target alarm as follows:

1. Press the **MENU/ESC** key to open the menu.
2. Select [Alarm], then press the **ENTER** key.
3. Select [Alarm Level], then press the **ENTER** key.
4. Select the echo strength level, among [Low], [Med] and [High].
5. Press the **ENTER** key followed by the **MENU/ESC** key.



2.20.7 How to turn the buzzer on/off

You can turn on/off the panel buzzer or external buzzer for target alarms. The panel buzzer is for this equipment. The external buzzer is for the optional buzzer, which is connected to this equipment to give the target alarm at a remote location.

1. Press the **MENU/ESC** key to open the menu.
2. Select [Alarm], then press the **ENTER** key.
3. Select [Panel Buzzer] (or [External Buzzer] for optional buzzer), then press the **ENTER** key.
4. Select [On] or [Off] then press the **ENTER** key.
5. Press the **MENU/ESC** key to close the menu.



2.21 How to Off-center the Display

You can off-center your ship position to expand the view field without selecting a larger range scale. The display can be off-centered manually, or automatically according to speed of the ship.

Note: Off-centering is not available in the true motion mode.

2.21.1 How to select the off-center mode

1. Press the **MENU/ESC** key to open the menu.
2. Select [Display], then press the **ENTER** key.
3. Select [Off-center mode], then press the **ENTER** key.

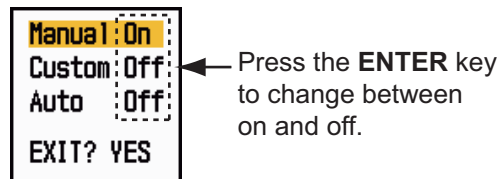

4. Select [Manual], [Custom] or [Auto] then press the **ENTER** key. Press the **ENTER** key again to change between on and off.
5. After setting all options, Select [EXIT? YES], then press the **ENTER** key.
6. Press the **MENU/ESC** key to close the menu.

2.21.2 How to off-center the display

The off-center features shifts own position according to the off-center mode selected.

The mode selected from the menu appears at top left corner of the display, when the off-center feature is activated - "OFFCENT(M)" (Manual), "OFFCENT(C)" (Custom) or "OFFCENT(A)" (Auto).

Manual off-center

You can move your ship position to the current cursor position on all modes except true motion, within 75% of the available display area.

1. Put the cursor on the position where to off-center the display.
2. Press the **MODE** key, select [Off-center], then press the **ENTER** key.

The indication "OFFCENT(M)" appears at the top left corner

Custom off-center

You can move your ship position to the position which you preset. Follow the procedure shown below to register the cursor position. Then, the display is off-centered by the amount set here, when you activate the off-center function.

1. Turn off the off-center display.
2. Put the cursor on the position where to off-center the display.

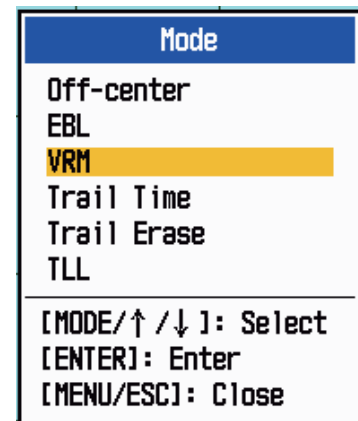

2. OPERATION

3. Press the **MODE** key, select [Off-center], then press the **ENTER** key.
4. Press the **MENU/ESC** key to open the menu.
5. Select [Display], then press the **ENTER** key.
6. Select [Save Offcenter], then press the **ENTER** key. The message "Complete" appears.
7. Press any key to close the message window.
8. Press the **MENU/ESC** key to close the menu.

The indication "OFFCENT(M)" appears at the top left corner

Automatic off-center

The amount of automatic move is calculated according to speed of the ship. The maximum amount is 75% of the range in use. The formula to calculate automatic shift is shown below.

$$\frac{\text{Speed of ship}}{\text{Offcenter speed setting}} \times 0.75 = \text{Amount of move (\%)}$$

If the offcenter speed setting is 15 knots and the speed of the ship is 10 knots, for example, the amount of move at the stern of your ship will be 50% of the available display area.

How to select offcenter speed

1. Press the **MENU/ESC** key to open the menu.
2. Select [Initial] sub menu in [System] menu, then press the **ENTER** key.
3. Select [Offcenter Speed], then press the **ENTER** key.
4. Select the speed to use, then press the **ENTER** key.
5. Press the **MENU/ESC** key to close the menu.

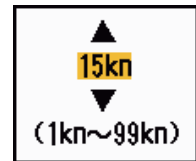

2.22 Zoom

The zoom function expands the length and width of a selected target as much as twice its normal size, in the zoom window. You select the target to zoom with the zoom cursor. The selected target is zoomed in the zoom window.

TT and AIS symbols can be displayed in the zoom window, but are not zoomed. You can process TT and AIS targets that are in the zoom window, in the same method as on the normal radar display.

2.22.1 Zoom reference

There are three types of zoom.

[Relative]: The zoom cursor is fixed to the range and bearing from your ship.

[True]: The zoom cursor is fixed to set geographical position.

[Target]: The zoom cursor is fixed to the zoomed AIS or TT target.

1. Press the **MENU/ESC** key to open the menu.
2. Select [Display], then press the **ENTER** key.

3. Select [Zoom Reference], then press the **ENTER** key.
4. Select [Relative], [True] or [Target] then press the **ENTER** key.
Note: True zoom mode requires a heading signal and position data.
5. Press the **MENU/ESC** key to close the menu.

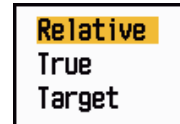

2.22.2 How to zoom

Relative or True zoom mode

1. Use the Cursorpad to put the cursor on the position desired.
2. Press the **MENU/ESC** key to open the menu.
3. Select [Display], then press the **ENTER** key.
4. Select [Zoom], then press the **ENTER** key.
5. Select [On], then press the **ENTER** key.
The ZOOM indication appears at the upper-left corner on the screen.
The zoom window and the zoom cursor also appear (see the illustration on the next page). To quit the zoom, select [Off] instead of [On], then press the **ENTER** key.

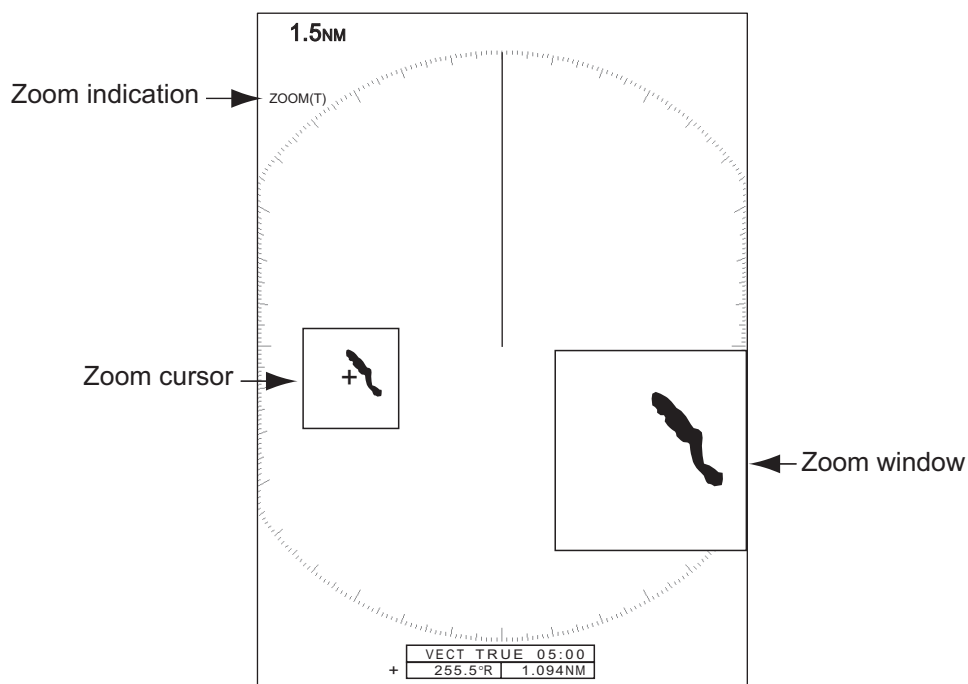

6. Press the **MENU/ESC** key to close the menu.

2. OPERATION

Target (AIS, TT) zoom mode

The TT or AIS target as below can be displayed in the zoom window:

TT: The symbol is enlarged twice its normal size. AIS: The symbol is enclosed in a broken square. (The symbol is not enlarged.)

The zoom cursor moves with the TT or AIS target.

Note: If neither TT nor AIS targets are selected, the message "NO TARGET." appears. Press any key to erase the message.

1. Press the **MENU/ESC** key to open the menu.
2. Select [Display], then press the **ENTER** key.
3. Select [Zoom], then press the **ENTER** key.
4. Select [On], then press the **ENTER** key.

The ZOOM indication appears at the upper-left corner on the screen. The zoom window and the zoom cursor also appear (see the following illustration). To quit the zoom, select [Off] instead of [On], then press the **ENTER** key.

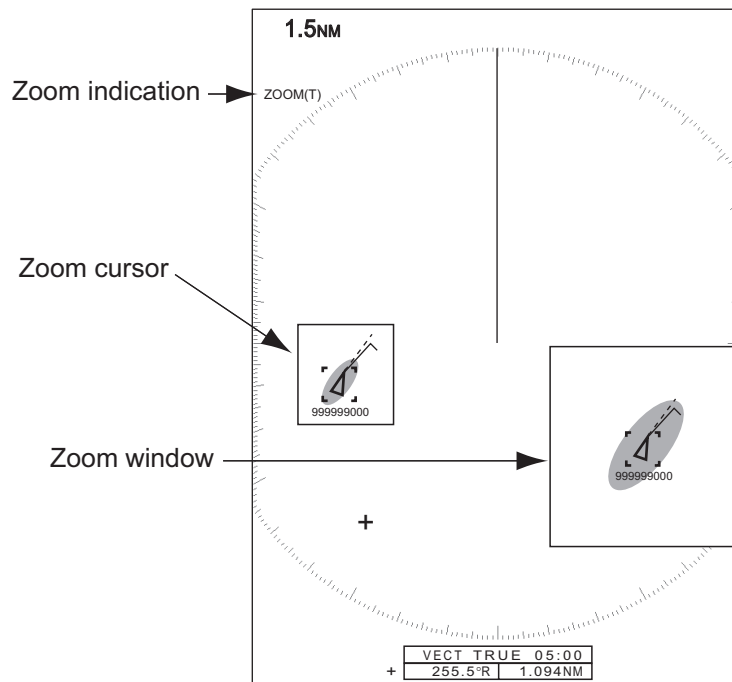

*Target zoom mode
(example: AIS)*

5. Press the **MENU/ESC** key to close the menu.

2.23 Echo Stretch

The echo stretch feature enlarges the targets in the range and bearing directions to make the targets easier to see. This feature is available on any range. There are three levels of echo stretch, [1], [2] and [3]. [3] enlarges the targets the most.

Note: The echo stretch magnifies the targets, sea and rain clutters, and radar interference. Correctly adjust the sea clutter, rain clutter and radar interference before you activate the echo stretch.

1. Press the **MENU/ESC** key to open the menu.
2. Select [Echo], then press the **ENTER** key.
3. Select [Echo Stretch], then press the **ENTER** key.
4. Select an echo stretch option, then press the **ENTER** key.
5. Press the **MENU/ESC** key to close the menu. When the echo stretch is active, "ES 1 (2, or 3)" appears at the lower-left corner on the display.

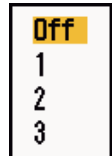

2.24 Target Trails

The trails of the radar targets can be shown simulated in afterglow to check target movement. The target trails are selected for either relative or true. True motion trails require a heading signal and position data.

2.24.1 Trail time

1. Press the **MODE** key to open the [Mode] window.
2. Select [Trail Time], then press the **ENTER** key.

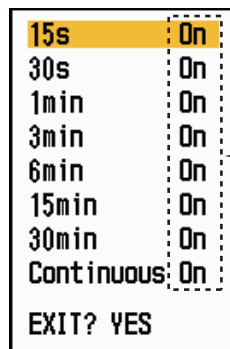

Press the **ENTER** key to change between on and off.

3. Select a time, then press the **ENTER** key.
4. Press the **MENU/ESC** key to close the menu.

The selected time appears at the top right corner.

2.24.2 Trail mode

You can display the echo trails in true or relative motion.

The selected trail mode and trail time appear at the top right corner.

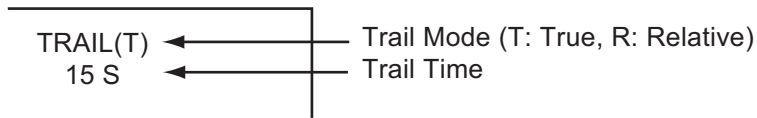

True mode

The true trails show true target movements according to their over-the-ground speeds and courses. The stationary targets do not show the trails. The true trails require a heading signal and position data.

Relative mode

The relative trails show other ships' movements relative to your ship. The stationary targets also show the trails.

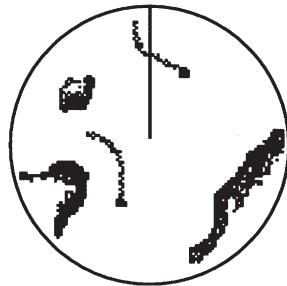

True target trails

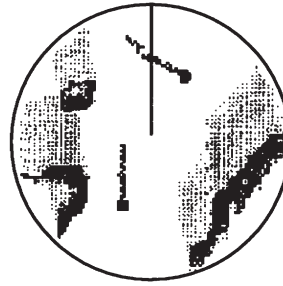

Relative target trails

To select the trail mode, do the following:

1. Press the **MENU/ESC** key to open the menu.
2. Select [Target Trails], then press the **ENTER** key.
3. Select [Mode], then press the **ENTER** key.
4. Select [Relative] or [True] then press the **ENTER** key.
5. Press the **MENU/ESC** key to close the menu.

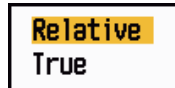

2.24.3 Trail gradation

Trails can be shown in single or multiple gradation. Multiple gradation fades the gradation over time.

1. Press the **MENU** key to open the menu.
2. Select [Target Trails], then press the **ENTER** key.
3. Select [Gradation], then press the **ENTER** key.
4. Select [Single] or [Multi] then press the **ENTER** key.

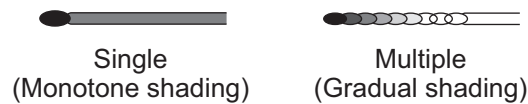

5. Press the **MENU** key to close the menu.

2.24.4 Trail color

You can select the color for trails as follows:

1. Press the **MENU** key to open the menu.
2. Select [Target Trails], then press the **ENTER** key.
3. Select [Color], then press the **ENTER** key.
4. Select a color, then press the **ENTER** key.
5. Press the **MENU** key to close the menu.



2.24.5 Trail level

You can select which target strength to display.

1. Press the **MENU/ESC** key to open the menu.
2. Select [Target Trails], then press the **ENTER** key.
3. Select [Level], then press the **ENTER** key.
4. Select [1], [2] or [3] then press the **ENTER** key.
 - [1]: Display the trails for all targets (including weak targets).
 - [2]: Display the trails for medium-to-strong level targets.
 - [3]: Display the trails for only strong targets.
5. Press the **MENU/ESC** key to close the menu.



2.24.6 How to restart, stop the trails

When the range is changed while the trail feature is active, trails within the previous range scale can be stopped and restarted.

1. Press the **MENU** key to open the menu.
2. Select [Target Trails], then press the **ENTER** key.
3. Select [Restart], then press the **ENTER** key.



2. OPERATION

4. Select [Off] or [On] then press the **ENTER** key.
[Off]: The previous trails data are saved when the range is changed. The trails are not restarted and the saved trails are not updated. When you return the range scale to the previous range scale, the saved trails are displayed and updated.
[On]: The previous trails are zoomed in or out depending on the changed scale and updated.

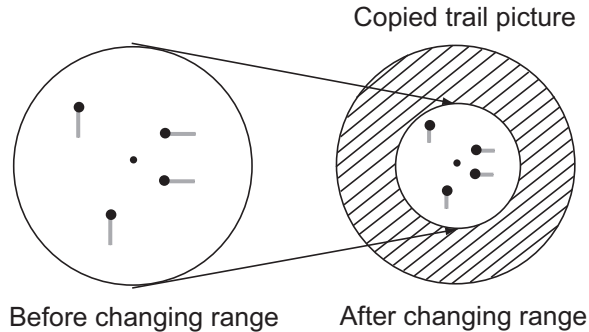

Note: If the newly selected range is less than or equal to 1/4 of the previous range, trails are erased. If the newly selected range is longer than the previous range, the previous trails are left to be displayed.

5. Press the **MENU** key to close the menu.

2.24.7 Narrow trails

You can display the target trails in thin trails. When there are many targets on the screen, you can separate trails close to one another with this function.

1. Press the **MENU/ESC** key to open the menu.
2. Select [Target Trails] then press the **ENTER** key.
3. Select [Narrow], then press the **ENTER** key.
4. Select [Off] or [On] then press the **ENTER** key.
5. Press the **MENU/ESC** key to close the menu.



2.24.8 Own ship trail

You can show the trail of your ship as follows:

1. Press the **MENU/ESC** key to open the menu.
2. Select [Target Trails], then press the **ENTER** key.
3. Select [Own Ship], then press the **ENTER** key.
4. Select [Off], [1] or [2] then press the **ENTER** key.
[Off]: Hide the trail of your ship.
[1]: Show the trail of your ship.
[2]: Show the trail of your ship, but hide the trail of sea clutter near your ship.
5. Press the **MENU/ESC** key to close the menu.

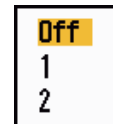

2.24.9 How to erase all trails

All trails can be erased by the methods shown below. A beep sounds upon completion of the erasure.

Erase all trails from the menu

1. Press the **MENU/ESC** key to open the menu.
2. Select [Target Trails], then press the **ENTER** key.
3. Select [Trail Erase], then press the **ENTER** key.
4. You are asked if you are sure to erase all trails. Press **▲** on the Cursorpad to select [Yes] then press the **ENTER** key.

Erase all trails with the MODE key

Press the **MODE** key to show the mode options. Select [Trail Erase], then press the **ENTER** key.

2.25 How to Program the FUNC Key

The **FUNC** key can be programmed to do the function you assign.

Function key operation

Press the **FUNC** key to do the function assigned to the key. Press the key successively to change the setting.

How to change a function key program

1. Press the **MENU/ESC** key to open the menu.
2. Select [Others], then press the **ENTER** key.
3. Select [FUNC Setup], then press the **ENTER** key.
4. Scroll through the list to select a function, then press the **ENTER** key. Below are the available functions. The default function is [Trail Time].

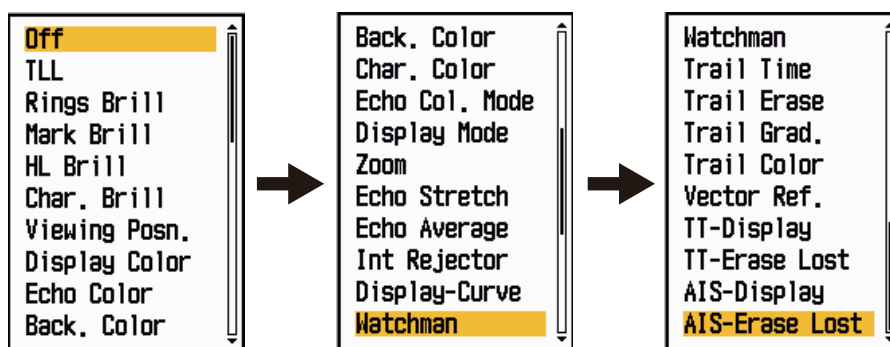

5. Press the **MENU/ESC** key to close the menu.

2.26 Echo Average

To identify true target echoes from the sea clutter, echoes are averaged over successive picture frames. If an echo is solid and stable, the echo is shown in its normal intensity. The brilliance of sea clutter is reduced to easily identify true targets from the sea clutter.

Note 1: Do not use the echo average function under heavy pitching and rolling. You can lose a target.

Note 2: This feature requires a heading signal and position data. When either signal becomes lost, echo average is deactivated.

To correctly use the echo average function, first reduce the sea clutter:

1. Press the **MENU/ESC** key to open the menu.
2. Select [Echo], then press the **ENTER** key.
3. Select [Echo Average], then press the **ENTER** key.
4. Select an echo averaging option, then press the **ENTER** key.

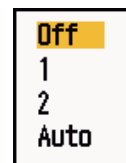

[Off]: Deactivate the echo average.

[1]: Identify true targets from the sea clutter and reduce the brilliance of unstable echoes.

[2]: Identify true targets from the sea clutter that you cannot reduce the brilliance with setting 1.

[Auto]: Identify true targets from the sea clutter. Detect far and unstable targets.

5. Press the **MENU/ESC** key to close the menu. The selected echo average ("EAV 1", "EAV 2" or "EAV(A)") appears at the lower-left corner of the display.

2.27 Wiper

The wiper feature automatically reduces the brilliance of unwanted weak signals (noise, sea clutter, rain clutter, etc.) and unnecessary signals, like radar interference, to clear the picture of unnecessary echoes. The result of wiper depends on the wiper setting used and whether echo averaging is turned on or off, as described below.

Echo averaging and wiper states and wiper effect

Echo average setting	Wiper Setting	
	Wiper 1	Wiper 2
Off	Processing content A	
On (1, 2, Auto)	Processing content A	Processing content B

Processing content A: The brilliance of unnecessary weak echoes, like noise and radar interference, is reduced to clear the picture. The difference between wiper 1 and 2 is that brilliance is lowered more slowly in 1.

Processing content B: Echo averaging is automatically turned on from off when the wiper feature is turned on. You can see how the picture changes with the echo averaging turned off and turned on.

To activate the wiper feature, do the following:

1. Press the **MENU/ESC** key to open the menu.

2. Select [Echo], then press the **ENTER** key.
3. Select [Wiper], then press the **ENTER** key.
4. Select [1] or [2] then press the **ENTER** key.
5. Press the **MENU/ESC** key to close the menu.



Note: This function is not available when the [Display Mode] is [True View].

2.28 Display-Curve

You can change the characteristics curve to reduce unwanted weak echoes (sea reflections, etc.). Select [1], [2] or [3] depending on conditions when unwanted weak echoes hide wanted targets.

1. Press the **MENU/ESC** key to open the menu.
2. Select [Echo], then press the **ENTER** key.
3. Select [Display-Curve], then press the **ENTER** key.
4. Select [1], [2] or [3] then press the **ENTER** key.
 - [1]: Reduce weak echoes.
 - [2]: Normal use
 - [3]: Display weaker echoes in stronger color compared to [1].

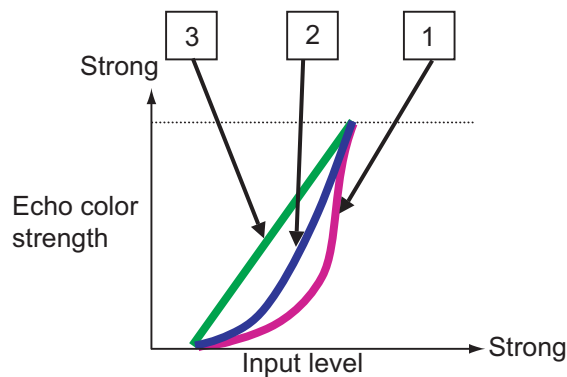

Display curve

5. Press the **MENU/ESC** key to close the menu.

2.29 Own Ship and Barge Mark

This section shows you how display and set up the own ship and barge marks.

2.29.1 How to show the own ship mark

1. Press the **MENU/ESC** key to open the menu.
2. Select [OS/Barge Mark], then press the **ENTER** key.
3. Select [OS Mark], then press the **ENTER** key.
4. Select [On], then press the **ENTER** key.



2. OPERATION

5. Select [OS Length] then press the **ENTER** key.
6. Set the length of own ship then press the **ENTER** key.
7. Select [OS Width] then press the **ENTER** key.
8. Set the width of own ship then press the **ENTER** key.
9. Press the **MENU/ESC** key to close the menu.



The own ship mark appears on the display, scaled according to the length and width entered here.



2.29.2 How to show the barge mark

The length and breadth of the total barge size can be displayed as a simple rectangle on the radar display. Up to five rows of barges and nine barges per row can be shown.

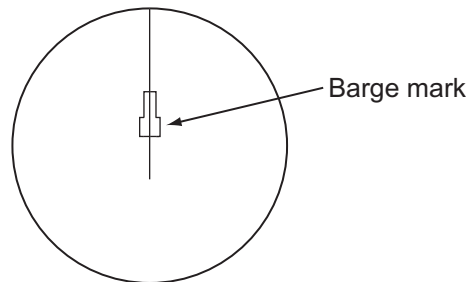

Note: Turn on [OS Mark] in the [OS/Barge Mark] menu to enable display of barge marks.

1. Press the **MENU/ESC** key to open the menu.
2. Select [OS/Barge Mark], then press the **ENTER** key.
3. Select [Barge Mark], then press the **ENTER** key.
4. Select [On], then press the **ENTER** key.
5. Select [Barge Position] then press the **ENTER** key.
6. Select [Bow] or [Stern], then press the **ENTER** key.

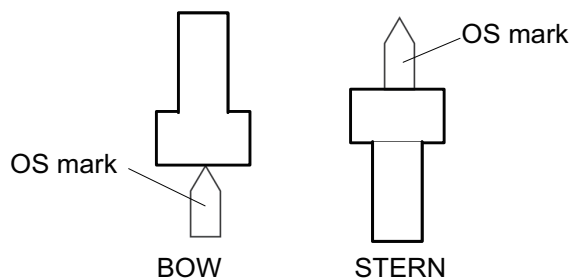

7. Select [Barge Length] then press the **ENTER** key.

8. Set the length of the barge, then press the **ENTER** key.
9. Select [Barge Beam] then press the **ENTER** key.
10. Select [Barge Arrangement], then press the **ENTER** key.

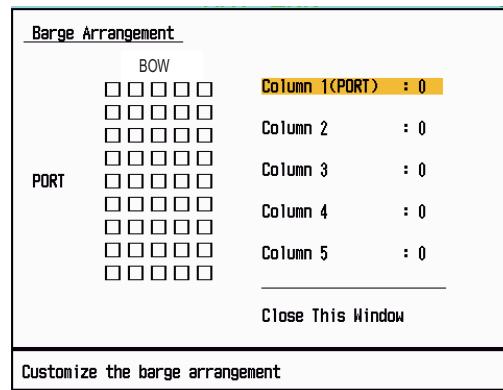

11. The cursor is selecting [Column1(PORT)]. Press the **ENTER** key.
12. Set the number of barges in the port column.
13. Set other columns similar to how you did in steps 11 and 12.
14. After setting all required columns, select [Close This Window], then press the **ENTER** key.
15. Press the **MENU/ESC** key to close the menu.

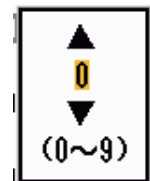

2.30 Watchman

The Watchman sounds the buzzer to tell the operator to check the radar display. The radar transmits for one minute and then goes into standby for the selected time interval. If the target alarm is active and a target is found in the alarm zone, Watchman is cancelled, and the radar transmits continuously.

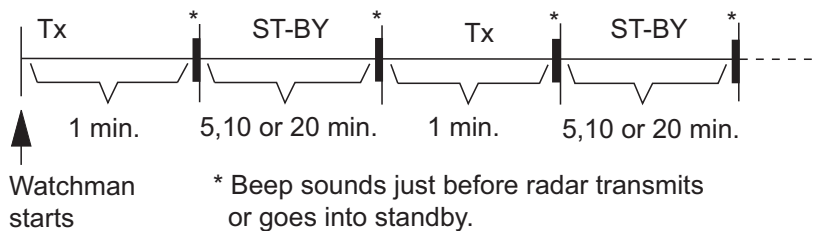

In standby, the timer near the <WATCH> label at the center of the screen counts down the remaining time until the transmission. When the set time interval has passed, the audio alarm sounds, the timer disappears and the radar transmits for one minute. After one minute, the audio alarm sounds and the watch alarm timer again begins the count-down sequence.

If you press the **STBY/TX** key before the set time interval comes, the radar goes into transmission.

Do the following to activate the Watchman:

1. Press the **MENU/ESC** key to open the menu.
2. Select [Alarm], then press the **ENTER** key.

2. OPERATION

3. Select [Watchman], then press the **ENTER** key.

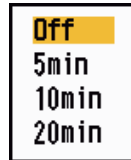

4. Select [Off] or a time ([5min], [10min] or [20min]) then press the **ENTER** key.
5. Press the **MENU/ESC** key to close the menu.

To turn off watchman, select [Off] at step 4.

2.31 Alert Status

The alert status window shows all currently violated alarms and system messages.

Note: The alert status window is not automatically displayed when an alarm occurs.

1. Press the **MENU/ESC** key to open the menu.
2. Select [Alert Settings], then press the **ENTER** key.
3. Select [Alert Status], then press the **ENTER** key.

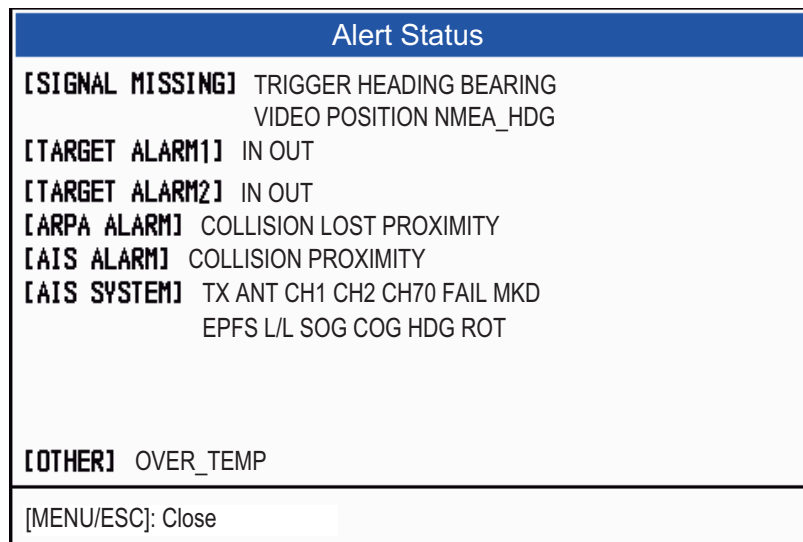

Alert Status display

4. Press the **MENU/ESC** key to close the [Alert Status] display.
5. Press the **MENU/ESC** key to close the menu.

See the next page for a list of alert status messages and their meanings.

Alert category	Meaning
SIGNAL MISSING*	
TRIGGER	Trigger signal lost
HEADING	Heading signal lost
BEARING	Bearing signal lost
VIDEO	Video signal lost
POSITION	NMEA format position data lost
NMEA_HDG	NMEA format heading signal lost
ANT_ERR	No data from antenna unit for one minute
TARGET ALARM1(2)	
IN	An echo has entered a target alarm zone.
OUT	An echo has exited a target alarm zone.
TT ALARM	
COLLISION	CPA and TCPA of an TT target is less than CPA and TCPA alarm settings.
LOST	Acquired TT target becomes lost.
PROXIMITY	The range to an TT target is less than the user-set proximity alarm range.
AIS ALARM	
COLLISION	CPA and TCPA of an AIS target is less than CPA and TCPA alarm settings.
LOST	AIS target becomes lost.
PROXIMITY	The range to an AIS target is less than the user-set proximity alarm range.
AIS SYSTEM*	
TX	TX stopped or TX error
ANT	Antenna VSWR problem
CH1	TDM2 RX1 board problem
CH2	TDM2 RX2 board problem
CH70	RX channel 70 problem
FAIL	System failure
UTC	UTC sync invalid
MKD	Minimum input device lost
GNSS	Internal/external GNSS position mismatch
NAV_STATUS	NAV status incorrect
HDG_OFFSET	Heading sensor offset
SART	Active AIS-SART
EPFS	Navigator (GPS, etc.) problem
L/L	Position data lost
SOG	Speed data lost
COG	Course data lost
HDG	Heading data lost
ROT	Rate of turn data lost
OTHER*	
OVER_TEMP	The temperature of the equipment is more than the specified value.

*: Have a qualified technician check the equipment.

2.32 Color Selections

2.32.1 Preset colors

This radar is preset with color combinations that provide best viewing in daytime, nighttime and twilight. Below are the default color settings for each display item and display color setting.

Display item, color design and color

Display item	Day	Night	Twilight	Custom
Characters	Black	Red	Green	Green
Range rings, marks	Green	Red	Green	Green
Echo	Yellow	Green	Green	Yellow
Background	White	Black	Blue	Black

1. Press the **MENU** key to open the menu.
2. Select [Brill/Color], then press the **ENTER** key.
3. Select [Display Color], then press the **ENTER** key.
4. Select the color design, then press the **ENTER** key.
5. Press the **MENU** key to close the menu.



2.32.2 Custom colors

The custom color design lets you select preferred echo, background, characters, range rings and marks colors. Select [Custom] in the [Display Color] menu item (see subsection 2.32.1) to use the user selected echo, background, characters, range rings and marks colors.

1. Press the **MENU/ESC** key to open the menu.
2. Select [Brill/Color], then press the **ENTER** key.
3. Select [Echo Color], then press the **ENTER** key.
4. Select an echo color, then press the **ENTER** key. [Multi] displays echoes in colors of red, yellow and green according to descending echo strength.
5. Select [Background Color], then press the **ENTER** key.
6. Select a background color, then press the **ENTER** key.
7. Select [Character Color], then press the **ENTER** key.
8. Select a character color (including range rings and marks), then press the **ENTER** key.
9. Press the **MENU/ESC** key to close the menu.



2.33 Echo Area

You can select the display area from [Normal] or [Full Screen].

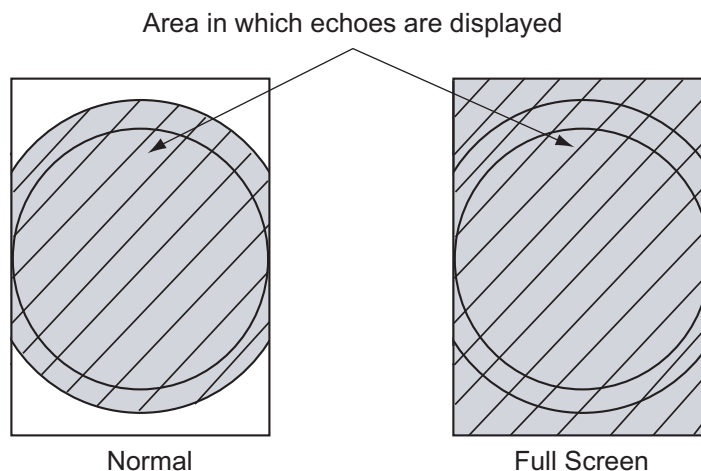

1. Press the **MENU/ESC** key to open the menu.
2. Select [Display], then press the **ENTER** key.
3. Select [Echo Area], then press the **ENTER** key.
4. Select [Normal] or [Full Screen] then press the **ENTER** key.
5. Press the **MENU/ESC** key to close the menu.

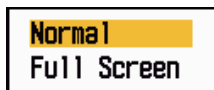

2.34 Initial Sub Menu

The [Initial] sub menu in the [System] menu contains items that allow you to customize your radar to meet your needs.

2.34.1 How to open the Initial sub menu

1. Press the **MENU** key to open the menu.
2. Select [Initial], then press the **ENTER** key.

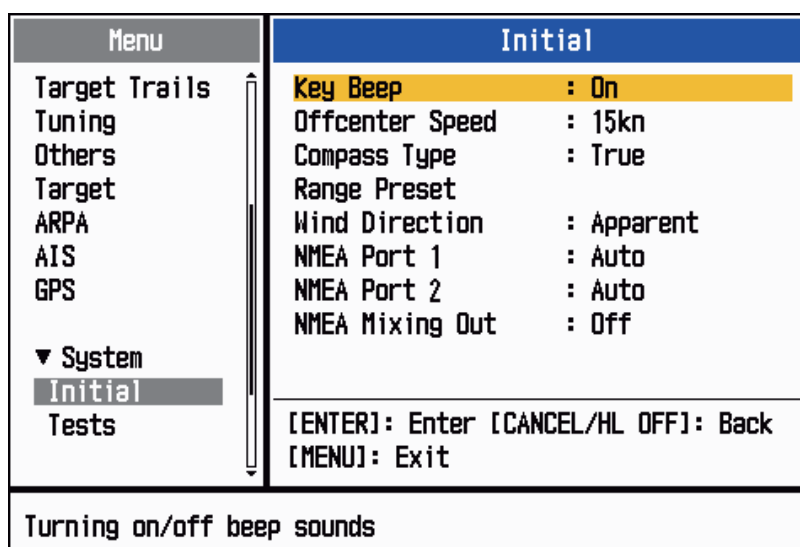

2.34.2 Description of Initial sub menu

[Key Beep]: When a key is pressed, a beep sounds. You can turn on or off this beep.

[Off-center Speed]: Set the speed of your ship to calculate amount of your ship's off-center. The setting range is 1-99 (kn).

[Compass Type]: Select the type of bearing sensor connected to the radar; [True] (gyrocompass, satellite compass) or [Magnetic] (magnetic compass).

[Range Preset]: You can select the radar ranges. Select a range, then press the **ENTER** key to switch on and off. At least two ranges must be turned on. The maximum range available depends on the radar model. 0.0625 is not available in KM (kilometers).

0.0625	On
0.125	On
0.25	On
0.5	On
0.75	On
1	Off
1.5	On
1.6	Off
2	Off
3	On
3.2	Off
4	Off
6	On
8	Off
12	On
16	Off
24	On
32	Off
36	On
48	Off
64	Off
Exit?	Yes

NM (nautical miles)

0.0625	Off
0.125	On
0.25	On
0.5	On
0.75	On
1	Off
1.5	On
1.6	Off
2	Off
3	On
3.2	Off
4	Off
6	On
8	Off
12	On
16	Off
24	On
32	Off
36	On
48	Off
64	Off
Exit?	Yes

KM (kilometers)

0.0625	On
0.125	On
0.25	On
0.5	On
0.75	On
1	Off
1.5	On
1.6	Off
2	Off
3	On
3.2	Off
4	Off
6	On
8	Off
12	On
16	Off
24	On
32	Off
36	On
48	Off
64	Off
Exit?	Yes

SM (statute miles)

[Wind Direction]: Wind direction is shown as [Apparent] or [True].

[NMEA Port 1]: Set the baud rate of the equipment connected to Port 1 ([Auto], [4800], or [38400] (bps)). [Auto] provides automatic detection of baud rate from 4800, 9600, 19200 or 38400 (bps).

[NMEA Port 2]: Same function as Port 1 but for Port 2.

[NMEA Mixing Out]: Data input to Port 1 may be output from Port 2 mixed with data output to Port 2. Select [On] to use this feature.

2.35 Sector Blank

You must prevent the transmission in some areas to protect passengers and crew from microwave radiation. Also, if the reflections of echoes from the mast appear on the screen, you must prevent the transmission in that area. You can set two sectors.

1. Press the **MENU/ESC** key to open the menu.
2. Select [Sector Blanks], then press the **ENTER** key.
3. Select [Sect-Blank 1 (or 2) Status], then press the **ENTER** key.
4. Select [On], then press the **ENTER** key.
5. Select [Sect-Blank 1 (or 2) Start], then press the **ENTER** key.
6. Set the start point of the sector, then press the **ENTER** key.
7. Select [Sect-Blank 1 (or 2) End], then press the **ENTER** key.
8. Set the end point of the sector, then press the **ENTER** key.
 - Note 1:** You can not set the sector more than 180 degrees.
 - Note 2:** You can not set the total width of sector 1 and sector 2 more than 270 degrees.
9. Press the **MENU/ESC** key to close the menu.

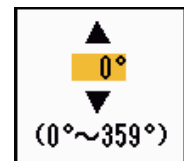
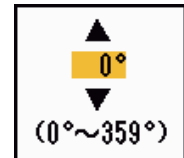

As shown in the following illustration, dashed lines mark the start and end points of the sector.

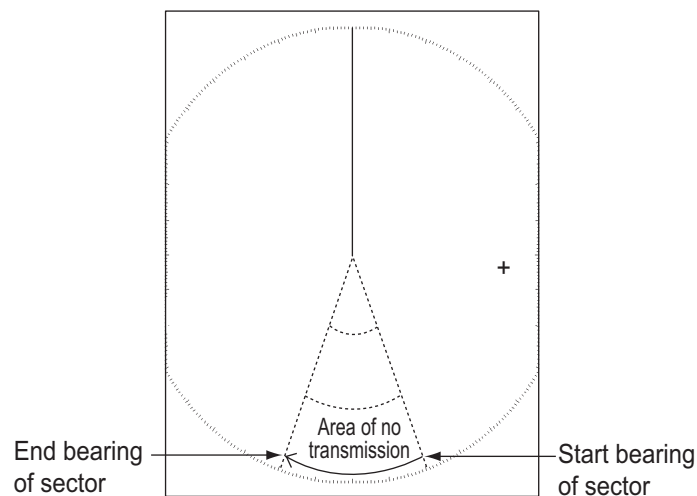

2.36 Other Menu Items

This section describes the menu items not previously described.

2.36.1 Brill/Color menu

[Echo Brill]: Adjust the brilliance of echoes.

[Ring Brill]: Adjust the brilliance of the range rings.

[Mark Brill]: Adjust the brilliance of all marks.

[HL Brill]: Adjust the brilliance of the heading line.

[Character Brill]: Adjust the brilliance of all characters.

[Viewing Position]: You can select the angle from where you see the screen.

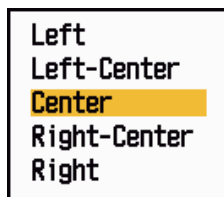

[Menu Transparency]: You can select the degree of transparency of the menu window so the menu window does not hide the echo display. [4] is the greatest degree of transparency. [Off] functions to hide the echo display behind the menu window completely.



Note: Alpha blending technology is used for transparency effects.

[Echo Color Mode]: You can select the color palette from [System] or [Custom]. [System] is the preset color palette and [Custom] is the color palette you can set yourself. This function is not available in the [IEC] or [Russian-River] mode.



[Custom Echo Color]: You can customize the echo color with the following two methods. This function is not available in the [IEC] or [Russian-River] mode.

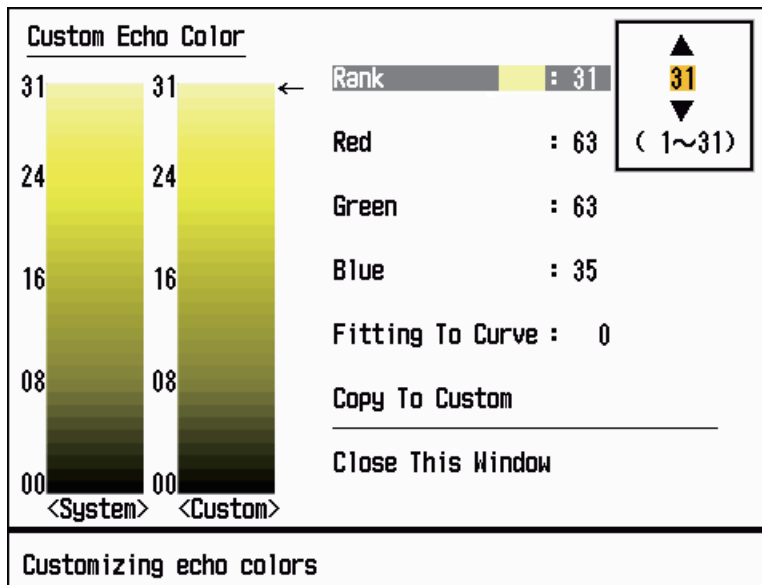

Custom Echo Color setting window

Method 1: 1) Select the echo rank to change on the [Rank] (setting range: 1 - 31).

2) Set the RGB values for selected echo rank on the [Red], [Green] and [Blue] (setting range: 0 - 63).

Method 2: 1) Select 31 on the [Rank].

2) Set the RGB values for 31 echo rank on the [Red], [Green] and [Blue] (setting range: 0 - 63).

3) Interpolate the RGB values between the maximum rank and minimum rank on the [Fitting To Curve] with the following curves (setting range: -20 to 20).

Setting range > 0: Logarithmic curve, useful to emphasize the weak echoes.

Setting range = 0: Straight line

Setting range < 0: Exponential curve, useful to emphasize the strong echoes.

[Copy To Custom]: Copy the color palette from [System] to [Custom].

2.36.2 Display menu

[Text Display]: You can select on/off for the text indications of the following items on the display. The settings on this function are used when you set [Echo Area] to [Full Screen] on the [Display] menu. This function is not available in the [IEC] or [Russian-River] mode.

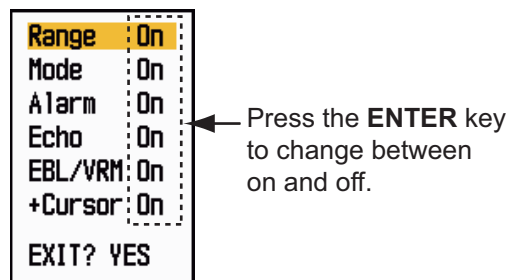

The text indications set to off appear when you operate any key. The indications disappear when there is no key operation for 10 seconds.

[STBY Display]: Set what to show on the standby display.

- [Normal]: Display "ST-BY" at the screen center.

- [Nav]: Display navigation data.

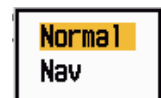

2.36.3 Echo menu

[Color Erase]: Erase the lower echo color whose level is set here. Set a large value to display only the stronger echoes.

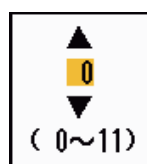

2.36.4 Units menu

You can select the unit of measurement for range, ship speed, depth, temperature and wind speed on the [Units] sub menu in the [System] menu. You can not open this sub menu in normal operation. To open this menu, select [Units], hold the **MENU/ESC** key, then press the **ALARM** key five times.

Menu	Units
Target	Range Unit : NM
ARPA	Ship Speed Unit : kn
AIS	Depth Unit : ft
GPS	Temperature Unit : °F
	Wind Speed Unit : kn
▼ System	
Initial	
Tests	
Sector Blanks	
Units	
Installation	[ENTER]: Enter [CANCEL/HL OFF]: Back [MENU]: Exit

Choosing an unit of range

[Range Unit]: NM, KM, SM

[Ship Speed Unit]: kn, km/h, mph

[Depth Unit]: m, ft, fa, pb, HR

[Temperature Unit]: °C, °F;

[Wind Speed Unit]: kn, km/h, mph, m/s

2.37 Navigation Data

2.37.1 Navigation data during standby

The navigation data is shown in standby when [STBY Display] on the [Display] menu is set to [Nav]. Appropriate sensors are required to display the data.

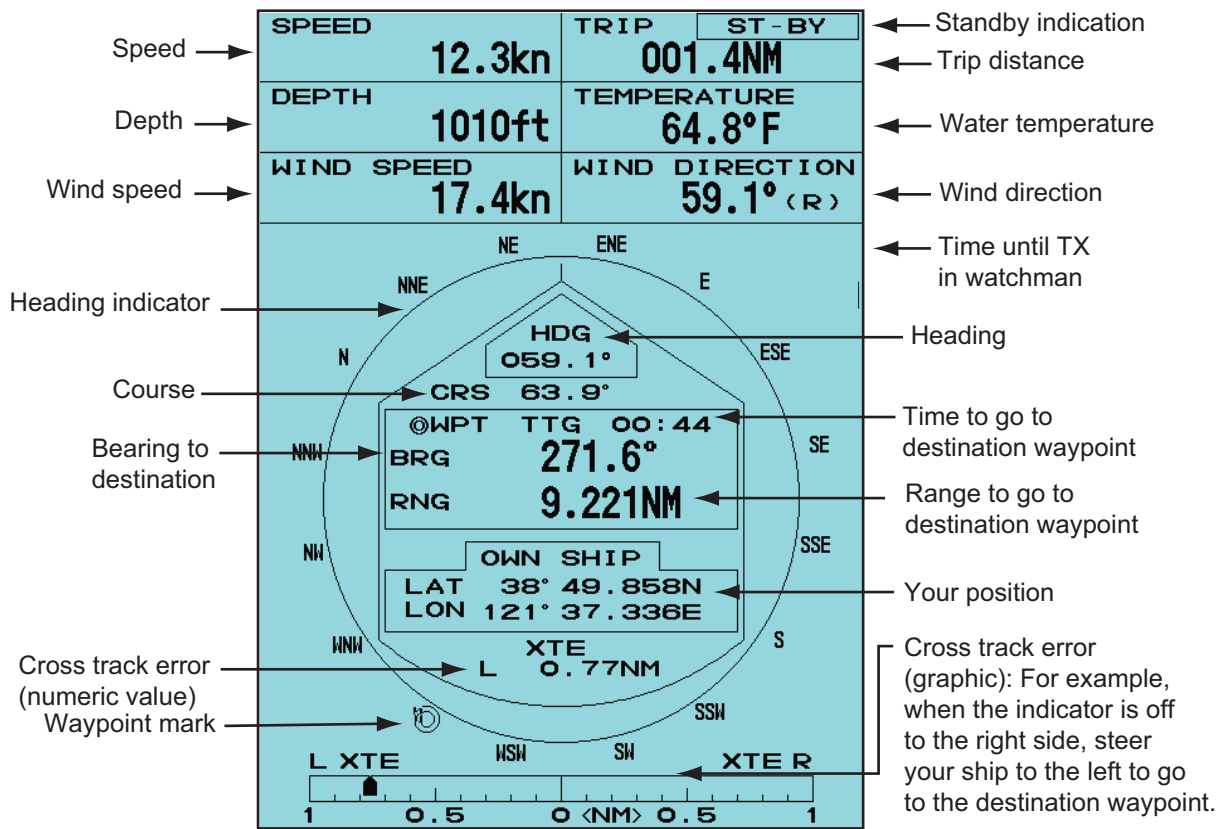

2.37.2 Navigation data at the bottom of the screen

Navigation data can be displayed at the bottom of the screen. The figure below shows the navigation data display

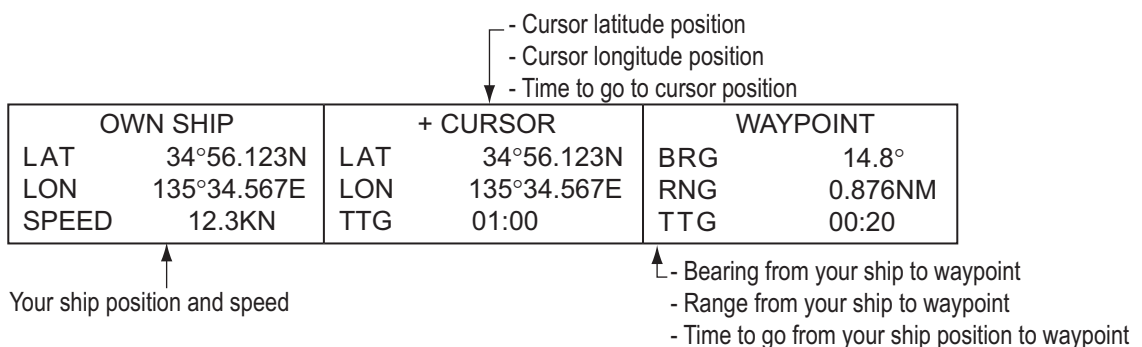

To show or hide the navigation data at the bottom of the screen, operate the **DATA BOX** knob to select [OFF], [NAV], [TGT] or [ALL].

[OFF]: Turn off the data box display.

[NAV]: Navigation data

[TGT]: TT and AIS data (see section 4.10, section 5.4.)

[ALL]: Navigation data plus TT and AIS target data

2.38 Waypoint Mark

The waypoint mark shows the location of the destination waypoint set on a navigation plotter. The heading signal or course data are required. You can turn on/off the waypoint mark as follows:

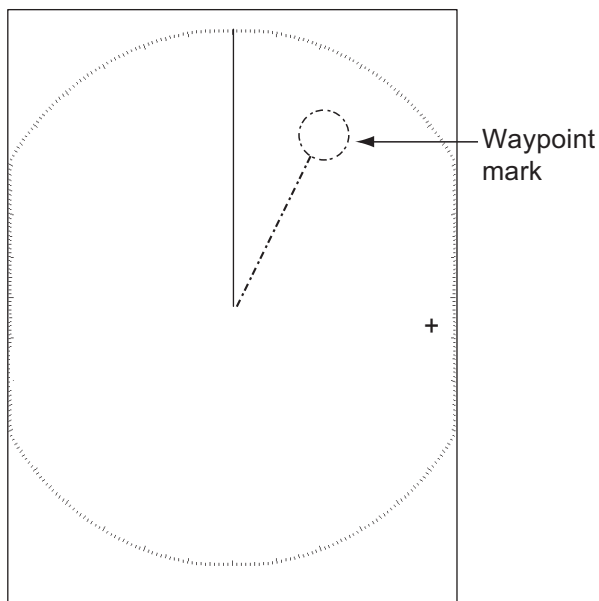

1. Press the **MENU/ESC** key to open the menu.
2. Select [Others], then press the **ENTER** key.
3. Select [WPT Mark], then press the **ENTER** key.



4. Select [Off] or [On] then press the **ENTER** key.
5. Press the **MENU/ESC** key to close the menu.

2.39 How to Send the Target Position and Enter the Origin Mark

The **TLL** function sends the cursor position to a chart plotter and put an origin mark () at the cursor position on the radar. Use the Cursorpad to put the cursor on a target. Press the **MODE** key to open the [Mode] window, select [TLL] then press the **ENTER** key. You can enter up to 20 origin marks on the radar display. When the capacity for origin marks is reached, the oldest mark is erased to make room for the latest mark, to keep a maximum of 20 marks. To erase a mark, put the cursor on the mark, then press the **MENU/ESC** key.

TLL mode

You can select how to handle TLL position.

1. Press the **MENU/ESC** key to open the menu.
2. Select [Others], then press the **ENTER** key.
3. Select [TLL Mode], then press the **ENTER** key.



4. Select [TLL Output], [Origin Mark] or [Both] then press the **ENTER** key.
 - [**TLL Output**]: Send the latitude and longitude of the cursor position to a chart plotter. (Position and heading signal are required.)
 - [**Origin Mark**]: Enter an origin mark at the cursor position on the radar display. (Position and heading signal are required.)
 - [**Both**]: Send the target position to a chart plotter and enter an origin mark on the radar display.
5. Press the **MENU/ESC** key to close the menu.

Note: All origin marks are deleted and not saved when the power is turned off.

2. OPERATION

This page is intentionally left blank.

3. HOW TO INTERPRET THE RADAR DISPLAY

3.1 General

3.1.1 Minimum and maximum ranges

Minimum range

The minimum range is defined by the shortest distance at which, using a scale of 0.0625 or 0.125 nm, a target having an echoing area of 10 m² is shown separate from the point representing the antenna position.

The minimum range depends on the pulse length, antenna height, and signal processing (like main bang suppression and digital quantization). Use a shorter range scale as far as it gives favorable definition or clarity of picture. This MODEL1815 meets the requirements of IEC 62252 5.14.1 (Class A).

Maximum range

The maximum detection range, R_{max}, varies depending on the height of the antenna, the height of the target above the sea, the size, shape and material of the target, and the atmospheric conditions.

Under normal atmospheric conditions, the maximum range is equal or a little shorter than the optical horizon. The radar horizon is longer than the optical one by approximately 6% because of the diffraction property of the radar signal. The R_{max} is shown in the following formula.

$$R_{\max} = 2.2 \times (\sqrt{h_1} + \sqrt{h_2})$$

where R_{max}: radar horizon (nautical miles)

h1: antenna height (m)

h2: target height (m)

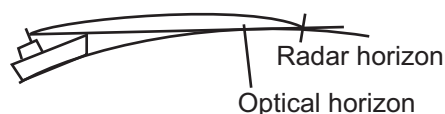

If the height of the antenna is 9 m and the height of the target is 16 m, the maximum radar range is;

$$R_{\max} = 2.2 \times (\sqrt{9} + \sqrt{16}) = 2.2 \times (3 + 4) = 15.4 \text{ nm}$$

Note: The detection range is reduced by precipitation (which absorbs the radar signal).

3.1.2 Radar resolution

The bearing resolution and range resolution are important in radar resolution.

Bearing resolution

The bearing resolution is the ability of the radar to display the echoes received from two targets at the same range as the separate echoes. The bearing resolution is proportional to the antenna length and the wavelength.

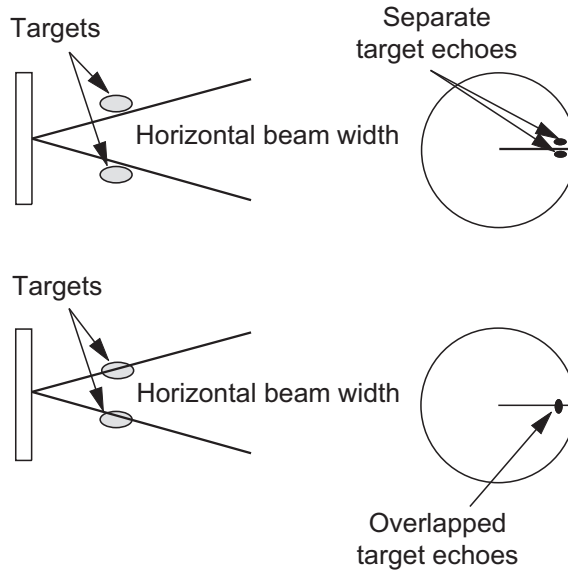

Range resolution

The range resolution is the ability to display the echoes received from two targets on the same bearing as separate echoes. The range resolution is determined by only pulse length.

The test targets used to determine the range and bearing resolution are radar reflectors that have an echoing area of 10 m².

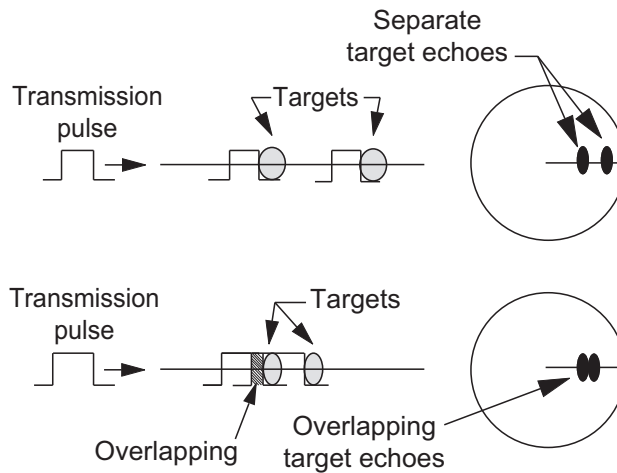

3.1.3 Bearing accuracy

One of the most important features of the radar is how accurately the bearing of a target can be measured. The accuracy of bearing measurement depends on the narrowness of the radar beam. The bearing is taken relative to the heading of the ship. Correct adjustment of the heading line at installation is important to get accurate bearings. To minimize the error when you measure the bearing of a target, put the target echo at the extreme position on the screen by selecting a suitable range.

3.1.4 Range measurement

Measurement of the range to a target is important function of the radar. There are three methods of measuring range: the fixed range rings, the Variable Range Marker (VRM), and the cursor (if set to measure range and bearing). The fixed range rings appear on the screen with a given interval and provide a rough estimate of the range to a target. The diameter of VRM is increased or decreased so that the marker touches the inner edge of the target. The VRM is a more accurate range measurement than the fixed range rings.

3.2 False Echoes

The echo signals can appear on the screen at positions where there is no target or disappear when there are targets. These false echoes are shown below.

3.2.1 Multiple echoes

Multiple echoes occur when a transmitted pulse returns from a solid object like a large ship, bridge, or breakwater. A second, a third or more echoes can be seen on the display at double, triple or other multiples of the actual range of the target as shown below. You can reduce and remove the multiple reflection echoes with the sea clutter function.

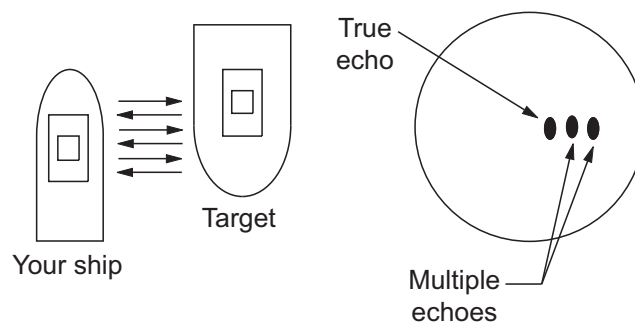

3.2.2 Sidelobe echoes

When the radar pulse is transmitted, some radiation escapes on each side of the beam, called "sidelobes". If a target is where a target can be detected by the sidelobes as well as the mainlobe, the side echoes can be shown on both sides of the true echo at the same range. Sidelobes show normally only on short ranges and from strong targets. You can reduce the sidelobes with the sea clutter function.

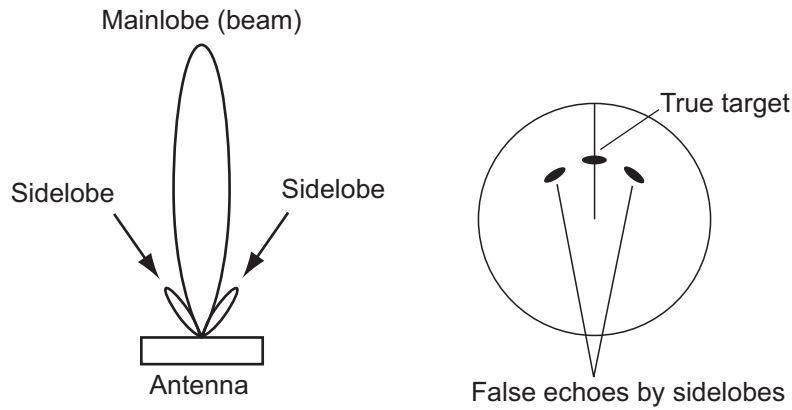

3.2.3 Virtual image

A large target close your ship can appear at two positions on the screen. One of them is the true echo reflected by the target. The other is a false echo which is caused by the mirror effect of a large object on or close your ship as shown in the following figure. If your ship comes close to a large metal bridge, for example, a false echo can temporarily appear on the screen.

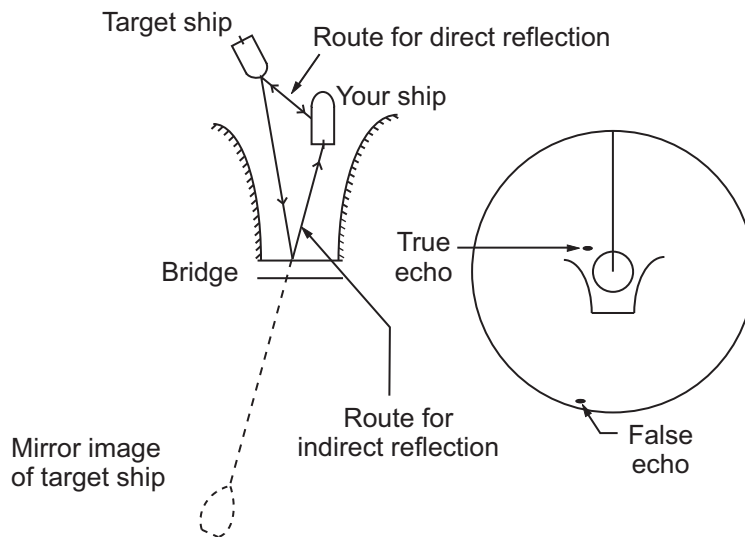

3.2.4 Shadow sector

Funnels, stacks, masts, or derricks near the antenna interrupt the radar beam, and a non-detecting sector can occur. Targets can not be detected within this sector.

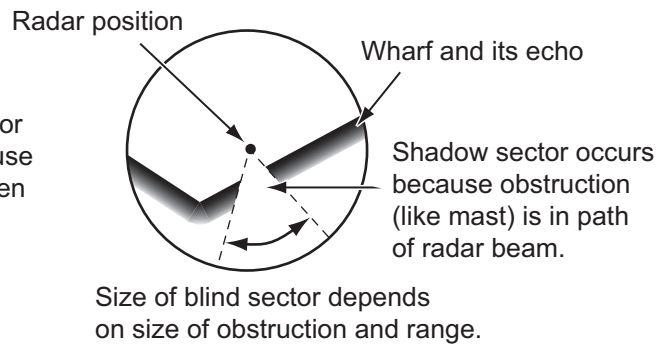
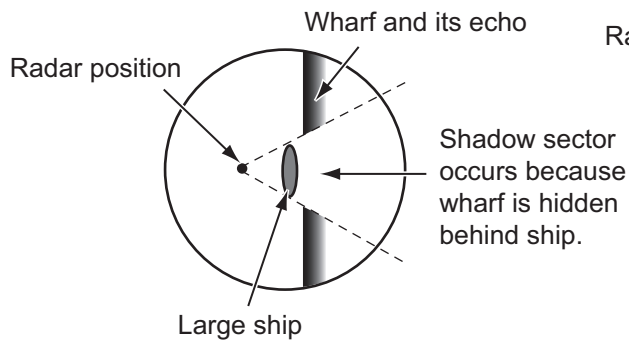

3.3 SART (Search and Rescue Transponder)

3.3.1 SART description

When any X-band radar reaches within a range of approximately 8 nm, a Search and Rescue Transponder (SART) sends a response to the radar signal. The transmitter signal of response is 12-sweeps signal between 9,500 MHz to 9,200 MHz. The time of slow sweep signal is $7.5 \mu\text{s}$ and the time of fast sweep signal is $0.4 \mu\text{s}$. When the radar receives this SART signal, a line of 12 dots appears. When the position of SART is distant, the radar display shows only slow sweep signals like the illustration of screen A.

When the radar reaches the SART within approximately 1 nm, the radar display can also show the 12 responses of fast sweep signals like the illustration of screen B. The position of the SART is the closest position of the radar echoes.

Screen A: When SART is distant

Screen B: When SART is close

Lines of 12 dots are displayed in concentric arcs.

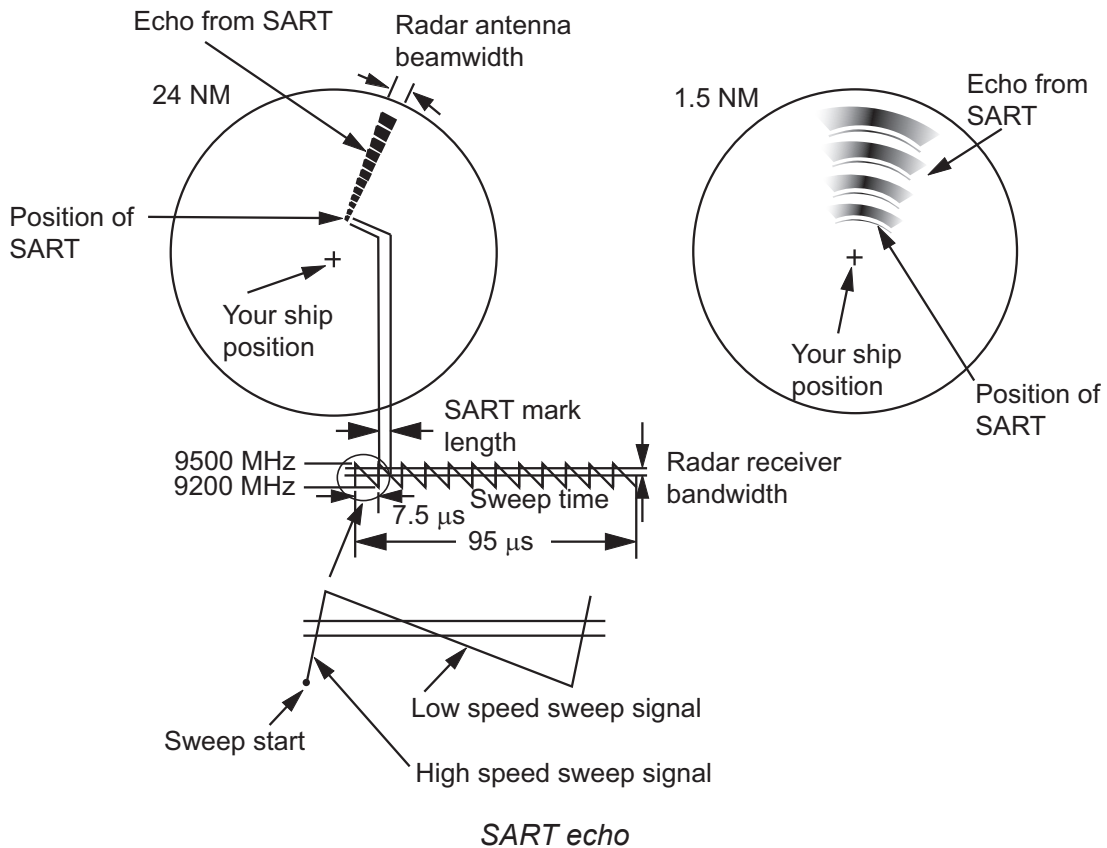

3.3.2 General remarks on receiving SART

SART range errors

When the SART is at a range greater than approximately 1 nm, the first dot is displayed at 0.64 nm beyond the true position of the SART. When the range closes so that the fast sweep responses are seen also, the first range echoes are displayed at 150 m beyond the true position.

Range scale

When you find the SART position, do as follows:

1. Use the **RANGE** key to set the range scale to 6 nm or 12 nm.
2. Turn off [Int Rejector].

SART display

To display only the SART echo clearly on the radar screen, reduce the tuning on manual mode. The normal radar echoes get weak, however, the SART echoes remain. Your ship comes close to the SART, the arc for the SART display becomes larger. Most of the radar screen becomes fuzzy. Adjust the sea clutter and gain to display the necessary screen.

3.4 RACON

A RACON is a radar beacon which emits radar-receivable signals in the radar frequency spectrum (X- or S-band). There are several signal formats; in general, the RACON signal appears on the radar screen as a rectangular echo originating at a point just beyond the position of the radar beacon. It has a Morse coded pattern. Note that the position on the radar display is not accurate.



Echoes on the radar screen

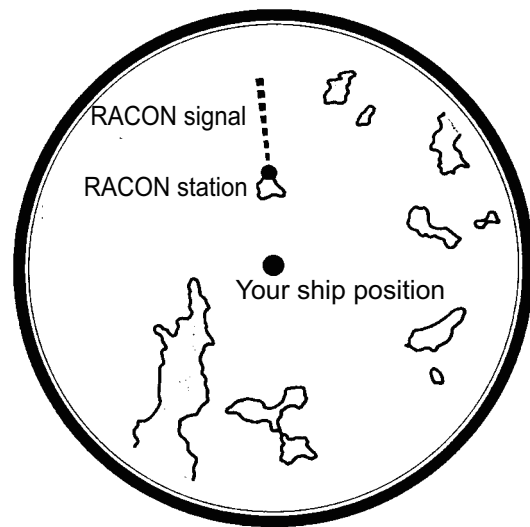



Echo description

4. TT OPERATION

The TT (Tracked Target) feature manually or automatically acquires and tracks ten targets. Once a target is acquired, a target is automatically tracked within 0.1 to 16 nm.

4.1 Precautions

 CAUTION
<p>Do not depend on one navigation device for the navigation of the ship. The navigator must check all aids available to confirm position. Electronic aids are not a replacement for basic navigation principles and common sense.</p> <ul style="list-style-type: none">· The TT automatically tracks an automatically or manually acquired radar target and calculates its course and speed, indicating them by a vector. Since the data from the auto plotter depend on the selected radar targets, the radar must be optimally tuned for use with the auto plotter, to ensure required targets will not be lost or unnecessary targets like sea returns and noise will not be acquired and tracked.· A target is not always a landmass, reef, ship, but can be returns from the sea surface and clutter. As the level of clutter changes with the environment, the operator must correctly adjust the rain clutter, sea clutter and gain controls so that the target echoes do not disappear from the radar screen.

 CAUTION
<p>The plotting accuracy and response of this TT meets IMO standards. The tracking accuracy is affected by the following:</p> <ul style="list-style-type: none">· The tracking accuracy is affected by course change. One to two minutes is required to restore vectors to full accuracy after a sudden course change. (The actual amount depends on gyrocompass specifications.)· The amount of tracking delay is inversely proportional to the relative speed of the target. Delay is on the order of 15-30 seconds for high relative speed; 30-60 seconds for low relative speed.
<p>The display accuracy is affected by the following:</p> <ul style="list-style-type: none">· Echo intensity· Pulse width of radar transmission· Radar bearing error· Gyrocompass error· Course change (your ship or target)

4.2 Controls for Use with TT

ENTER key: Acquire cursor-selected target. Display data for tracked target (in the data box at the bottom of the screen).

MENU/ESC key: (1) Remove data of cursor-selected tracked target from the data box. (2) Stop tracking the cursor-selected target (when its data is not displayed in the data box). (3) Access the [Target] and [TT] menus for TT operations.

Cursorpad: Select a target to acquire (or cancel the tracking). Select a target to show (or remove) target data.

4.3 TT Display On/Off

You can turn the TT display on or off. The system continuously tracks TT regardless of this setting.

1. Press the **MENU/ESC** key to open the menu.
2. Select [TT], then press the **ENTER** key.
3. Select [Display], then press the **ENTER** key.
4. Select [Off] or [On], then press the **ENTER** key.
5. Press the **MENU/ESC** key to close the menu.



4.4 TT Symbol Color

You can select the TT symbol color from Green, Red, Blue, White or Black.

1. Press the **MENU/ESC** key to open the menu.
2. Select [TT], then press the **ENTER** key.
3. Select [Color], then press the **ENTER** key.
4. Select the color, then press the **ENTER** key.
5. Press the **MENU/ESC** key to close the menu.



Note: Symbols can not be shown in the same color as the background color.

4.5 How to Acquire and Track the Targets

Ten targets are acquired and tracked manually or automatically.

4.5.1 Manual acquisition

You can acquire up to ten TT. When the automatic acquisition ([Auto Acquisition] on the [TT] menu) is set to on, you can manually acquire up to five targets.

1. Use the Cursorpad to put the cursor on the target to acquire.
2. Press the **ENTER** key.

The TT symbol changes over time as below. A vector, which indicates the motion direction of the target, appears shortly after acquisition.

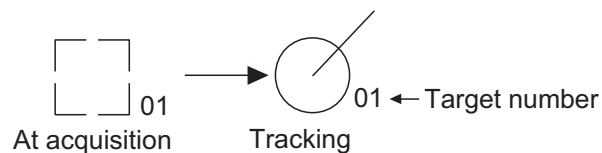

Target number

A maximum of ten targets can be acquired and tracked. When a target is lost and a new target is acquired and tracked, it is assigned the youngest empty target number.

4.5.2 Automatic acquisition

When you set an automatic acquisition area, the TT can acquire up to five targets automatically.

The automatic acquisition area is 2.0 to 2.5 nm in range and $\pm 45^\circ$ on either side of the heading line in bearing. When you change the automatic acquisition to manual acquisition, targets being tracked in automatic acquisition are continuously tracked.

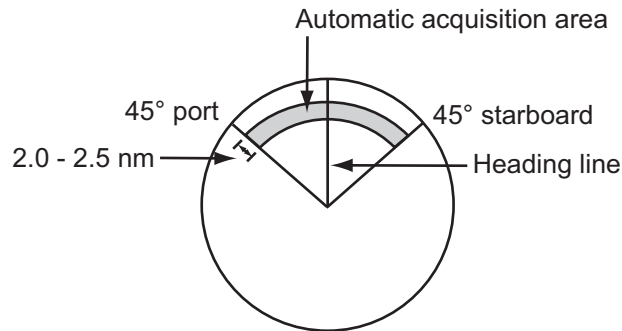

1. Press the **MENU/ESC** key to open the menu.
2. Select [TT], then press the **ENTER** key.
3. Select [Auto Acquisition], then press the **ENTER** key.
4. Select [On], then press the **ENTER** key.
5. Press the **MENU/ESC** key to close the menu.



4.6 How to Stop Tracking a TT

When ten targets have been acquired, no more acquisition occurs unless targets are cancelled. If you acquire additional targets, you must cancel one or more individual targets, or all targets. Use one of the following procedures.

4.6.1 How to stop tracking a single target

1. Use the Cursorpad to put the cursor on the target to cancel the tracking.
2. Press the **MENU/ESC** key to cancel the tracking and erase the TT symbol. The unit beeps twice and the symbol is erased from the screen.

4.6.2 How to stop tracking all targets

1. Press the **MENU/ESC** key to open the menu.
2. Select [TT], then press the **ENTER** key.
3. Select [All Cancel], then press the **ENTER** key.
4. Use the Cursorpad (\blacktriangle) to select [Yes], then press the **ENTER** key. All symbols are erased from the screen and the long beep sounds.
5. Press the **MENU/ESC** key to close the menu.

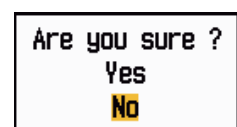

4.7 Lost Target

When the system detects a lost TT, the audio alarm sounds and the alarm message "LOST" appears. The target symbol becomes a flashing square like the following illustration. When the system detects the target again, the target symbol becomes a normal symbol.



To erase a lost TT symbol, put the cursor on the symbol, then press the **MENU/ESC** key. If you leave a lost target symbol flashing, the symbol disappears after one minute.

You can remove all lost TT from the screen as follows:

1. Press the **MENU/ESC** key to open the menu.
2. Select [TT], then press the **ENTER** key.
3. Select [Erase Lost Targets], then press the **ENTER** key.

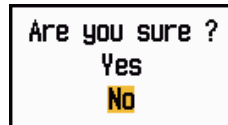

4. Use the Cursorpad (**▲**) to select [Yes], then press the **ENTER** key. All lost targets symbols are erased from the screen and the long beep sounds.
5. Press the **MENU/ESC** key to close the menu.

4.8 Vector Attributes

4.8.1 What is a vector?

A vector is a line extending from a tracked target. A vector shows speed and course of the target. The top of a vector shows estimated position of the target after the selected vector time elapses. If you extend the vector length (time), you can evaluate the risk of collision with any target.

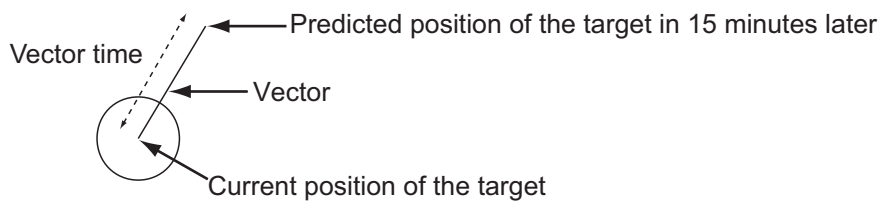

4.8.2 Vector time and vector reference

1. Press the **MENU/ESC** key to open the menu.
2. Select [Target], then press the **ENTER** key.

Menu	Target
Display	Vector Time : 6min
Echo	Vector Reference : True
Custom 1	History Dots : 5
Custom 2	History Interval : 1min
Custom 3	CPA : Off
Alarm	TCPA : 1min
Target Trails	Proximity : Off
Tuning	
Others	
Target	
ARPA	
	[ENTER]: Enter [CANCEL/HL OFF]: Back [MENU]: Exit
Adjusting a vector time to be displayed	

Target menu

3. Select [Vector Time], then press the **ENTER** key.



4. Select time, then press the **ENTER** key.
5. Select [Vector Reference], then press the **ENTER** key.
6. Select [Relative] or [True] then press the **ENTER** key.

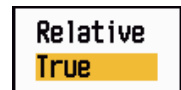

[Relative]: Other ships' vectors are displayed relative to your ship. This mode helps find targets on a collision course. If a ship is on a collision course with your ship, the vector of a ship points toward your ship position.

[True]: Your ship's and other ships' vectors are displayed at their true motions. This mode helps discriminate between moving and stationary targets.

7. Press the **MENU/ESC** key to close the menu.

Note: The functions of the [Target] menu are shared by TT and AIS.

4.8.3 Own ship vector

The vector of own ship is shown as an arrow from your ship position. The vector of own ship is shown on the following conditions:

- Select [True] on the menu item [Vector Reference] on the [Target] menu.

Note: The vector of own ship is shown in the same color as the TT symbol color.

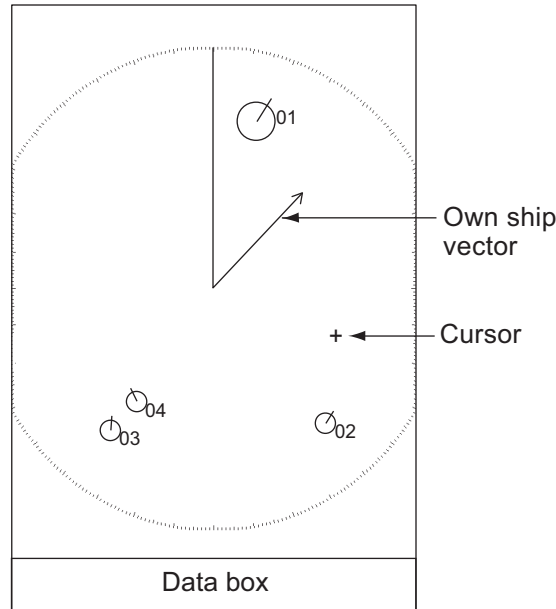

4.9 Past Position Display (target past position)

This radar can display time-spaced dots (maximum ten dots) that mark the past positions of any TT. You can evaluate actions of a target by the spacing between dots. Below are examples of dot spacing and target movement.

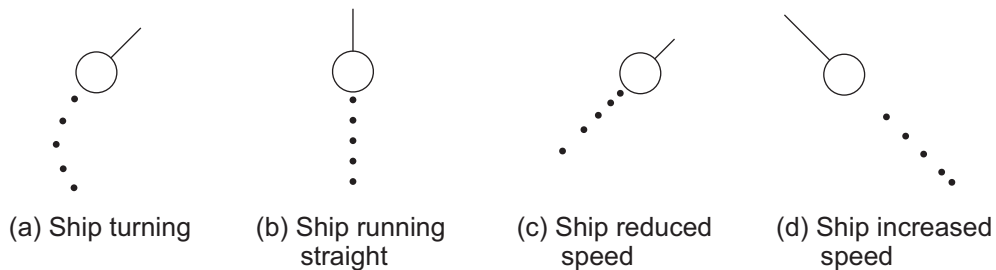

You can select the number of past position dots to display and the time interval to display the dots.

1. Press the **MENU/ESC** key to open the menu.
2. Select [Target], then press the **ENTER** key.
3. Select [Past Positions], then press the **ENTER** key.



4. Select number of past position dots to display (5 or 10) or select [Off] to turn off the history display.
5. Press the **ENTER** key.
6. Select [Past Posn Interval], then press the **ENTER** key.
7. Select the time interval, then press the **ENTER** key.
8. Press the **MENU/ESC** key to close the menu.

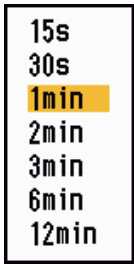

4.10 TT Data

You can show TT data at the bottom of the screen. Set the **DATA BOX** knob to the [Target] (TT data) or [All] (TT data + nav data) position.

1. Use the Cursorpad to put the cursor on an TT.
2. Press the **ENTER** key to show the data of the target.

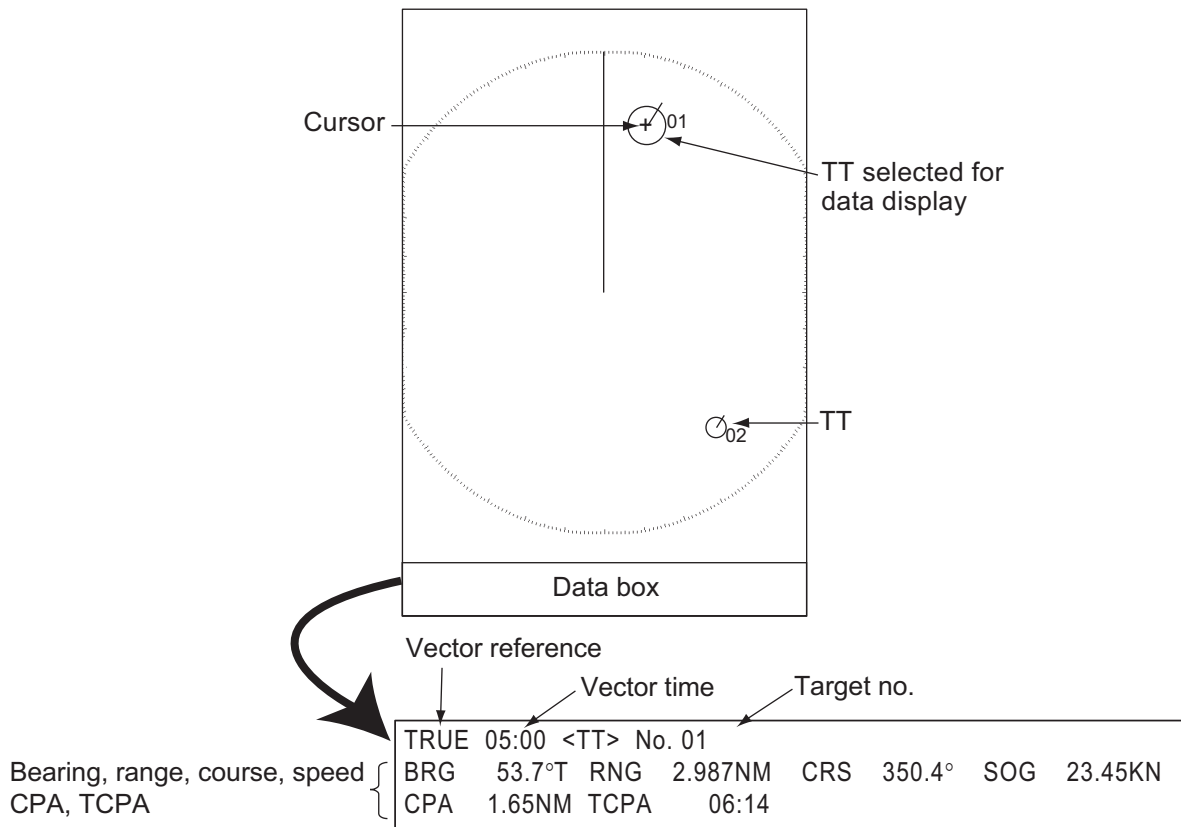

TT data

The symbol for the selected TT is enlarged double to distinguish from other symbols.

To remove the data of a target from a data box, put the cursor on the corresponding target symbol, then press the **MENU/ESC** key.

4.11 CPA/TCPA Alarm

Set CPA (Closest Point of Approach) alarm range and TCPA (predicted Time to CPA) alarm time to alert you to targets that can be on a collision course. When CPA and TCPA of any TT become less than the preset CPA and TCPA alarm settings, the audio alarm sounds. The alarm message "COLLISION" appears. The target symbol changes to a dangerous target symbol (triangle) and flashes with its vector. You can stop the audio alarm with any key. The flashing of the triangle stops when the tracked TT is not in the CPA and TCPA alarm setting. The TT continuously monitors CPA and TCPA of all TT.

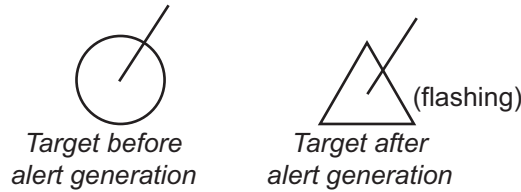

This feature helps identify targets that can be on a collision course. Correctly adjust the gain, sea clutter and rain clutter.

CAUTION

Do not depend on the CPA/TCPA alarm as the only method to detect the risk of collision. The navigator is not released of the responsibility to keep visual caution for collision situations, whether or not the radar or other plotting aid is in use.

1. Press the **MENU/ESC** key to open the menu.
2. Select [Target], then press the **ENTER** key.
3. Select [CPA], then press the **ENTER** key.

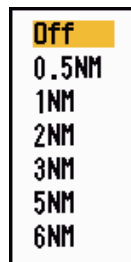

CPA options

4. Select CPA distance, then press the **ENTER** key.

5. Select [TCPA], then press the **ENTER** key.

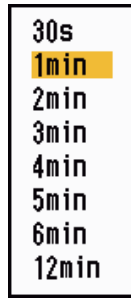

TCPA options

6. Select TCPA, then press the **ENTER** key.
7. Press the **MENU/ESC** key to close the menu.

4.12 Proximity Alarm

The proximity alarm alerts you when a TT is within the range you set. (The setting is commonly shared between TT and AIS. See section 5.12.) The audio alarm sounds and the alarm message "PROXIMITY" appears. The target symbol changes to a dangerous target symbol and flashes with its vector. Press any key to stop the audio alarm. The flashing continues until the target is not within the range set, the alarm range is changed to exclude the target, or the proximity alarm is deactivated.



1. Press the **MENU/ESC** key to open the menu.
2. Select [Target], then press the **ENTER** key.
3. Select [Proximity], then press the **ENTER** key.

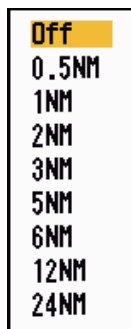

Proximity options

4. Select the range, then press the **ENTER** key.
5. Press the **MENU/ESC** key to close the menu.

4. TT OPERATION

This page is intentionally left blank.

5. AIS OPERATION

Connected to the FURUNO AIS Transponders FA-170, FA-150, FA-100, FA-50, or the AIS Receiver FA-30, the MODEL 1815 can show the name, position and other navigation data of the nearest 100 AIS transponder-equipped ships.

This radar accepts position data fixed by WGS-84 geodetic datum. Set the datum to WGS-84 on the GPS navigator connected to this radar, if this radar is connected to the FURUNO GPS Navigator GP-320B.

Controls for Use with AIS

ENTER key: (1) Activate the cursor-selected target, (2) Display data for selected active target (in the data box at the bottom of the screen).

MENU/ESC key: Remove data of cursor-selected AIS target from the data box. Sleep cursor-selected target (when its data is not displayed in the data box). Access the [Target] and [AIS] menu.

Cursorpad: Select a target to activate (or sleep). Select a target to show (or remove) target data.

5.1 AIS Display On/Off

You can turn the AIS display on or off. With the display turned off, the system continues processing AIS targets if the AIS transponder is turned on.

1. Press the **MENU/ESC** key to open the menu.
2. Select [AIS], then press the **ENTER** key.











Menu	AIS
Display	Display : Off
Echo	Color : Green
Alert Settings	Number of Targets : 30
Trails	Sort By : Range
Tuning	Range : 24.0NM
Others	Sector Start : 340°
Target	Sector End : 20°
OS/Barge Mark	Ignore Slow Targets : 5.0kn
TT	Erase Lost Targets
AIS	[ENTER]: Enter
GPS	[MENU/ESC]: Back
Show/hide AIS targets	

3. Select [Display], then press the **ENTER** key.
4. Select [Off] or [On] then press the **ENTER** key.
 [Off]: All AIS symbols are erased from the screen.
 [On]: AIS function is active, and a maximum of 100 target symbols are shown.
5. Press the **MENU/ESC** key to close the menu.



5.2 AIS Symbols

When the AIS is turned on, AIS targets are displayed with AIS symbol as below.

Target type	Symbol	Description
Sleeping target		Sleeping target
Activated target		Activated target. Heading line and ROT are shown. Ground tracking speed and course are shown with vector.
Dangerous target		A target whose distance, CPA and TCPA are less than corresponding alarm settings.
Lost target		A target for which no data has been received within a certain period. The symbol flashes.
Selected target		A target selected to show its target data.
Aid to navigation (AtoN)	 (Physical)  (Virtual)	
AIS base station		Always shown on the screen.
SART aircraft		Always shown on the screen.
AIS-SART		Always shown on the screen.

Note: The AIS symbols are momentarily erased after the screen is redrawn when the heading is changed in the head up mode.

5.3 Activating, Sleeping Targets

When you change a sleeping target to an activated target, a vector shows the course and speed of that target. You can easily judge the target movement by the length and pointing direction of the vector.

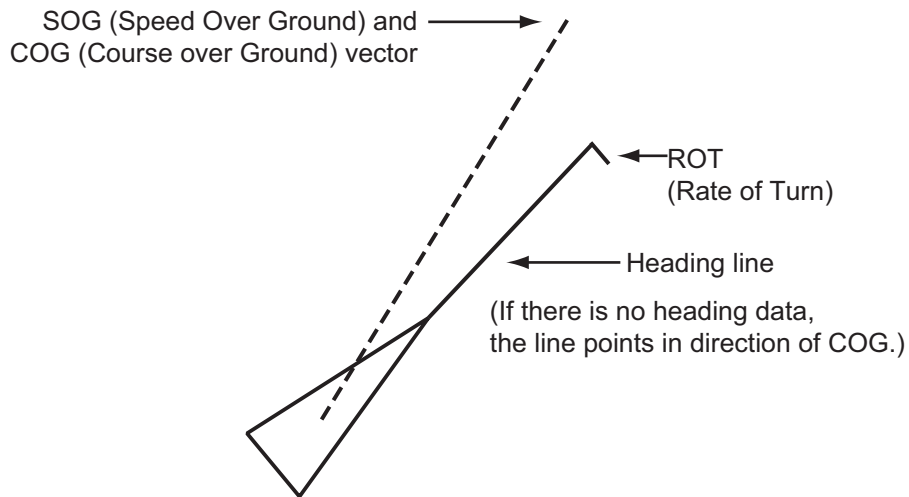

When there are many activated targets on the screen, an activated target may hide radar images or TT. You can sleep an activated target to unhide image or TT.

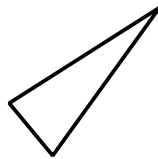

To activate a target: Put the cursor on the target, then press the **ENTER** key.

To sleep a target: Put the cursor on the target, then press the **MENU/ESC** key.

5.4 AIS Target Data

You can show AIS target data at the bottom of the screen. Set the **DATA BOX** knob to the [Target] (AIS data) or [All] (AIS data + nav data) position.

1. Use the Cursorpad to put the cursor on an activated target.
2. Press the **ENTER** key to show the data of the target.

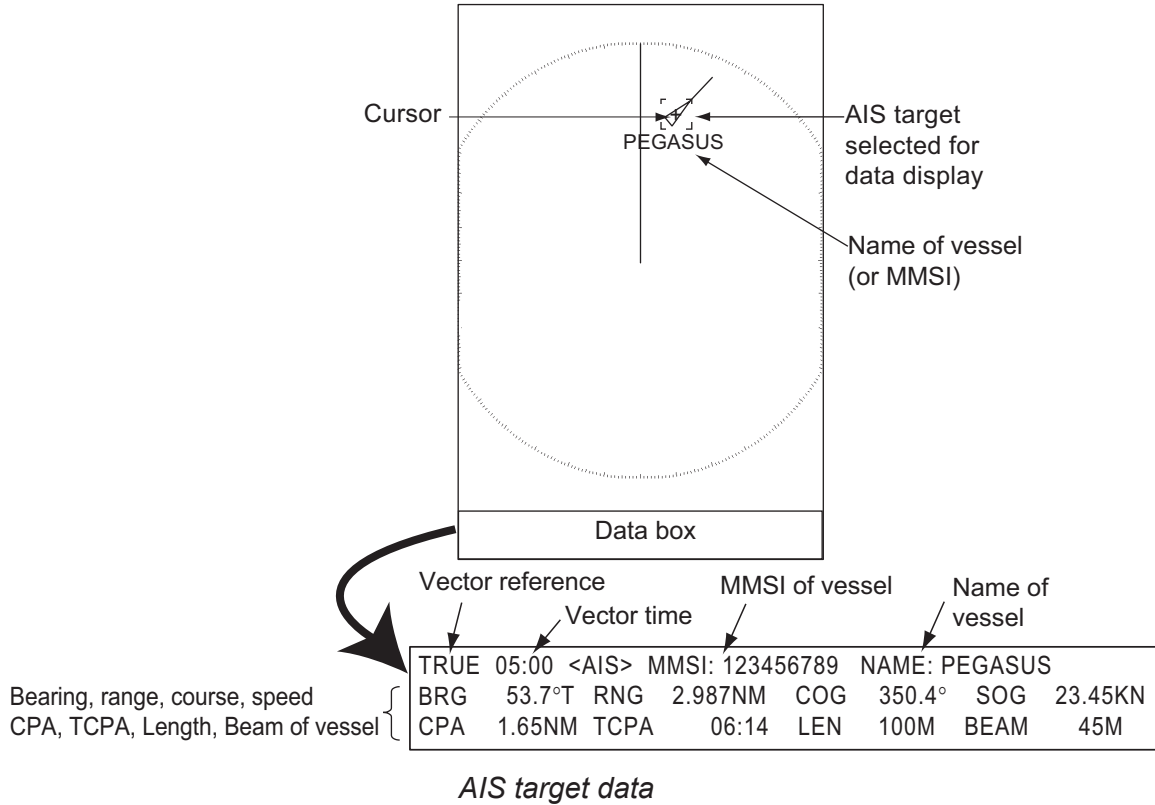

To remove the target data from a data box, put the cursor on the corresponding target symbol, then press the **MENU/ESC** key.

5.5 How to Sort Targets

You can sort the AIS targets received from the AIS transponder by range from your ship, by sector, by CPA or TCPA.

1. Press the **MENU/ESC** key to open the menu.
2. Select [AIS], then press the **ENTER** key.
3. Select [Sort By], then press the **ENTER** key.
4. Select sorting method, then press the **ENTER** key.
 - [Range]: Sort targets within the display range set (see section 5.6), from nearest to furthest.
 - [Sector]: Sort targets within the display sector set (see section 5.7) and within 24 nm, from nearest to furthest.
 - [CPA]: Sort targets within 24 nm by CPA, from closest to furthest.
 - [TCPA]: Sort targets within 24 nm by TCPA, from earliest time to latest time.
5. Press the **MENU/ESC** key to close the menu.

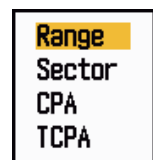

5.6 Display Range

You can set the AIS system to show only those AIS targets within the range you set. The setting range is 0.1-36 nm. Actual range depends on the AIS Transponder. If the target sorting method is selected to [Range], the target data within the range set here is transmitted to this radar.

1. Press the **MENU/ESC** key to open the menu.
2. Select [AIS], then press the **ENTER** key.
3. Select [Range], then press the **ENTER** key.
4. Set the display range, then press the **ENTER** key.
5. Press the **MENU/ESC** key to close the menu.

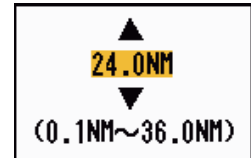

Note: The unit of measurement for range is NM.

5.7 How to Display the Targets within a Specific Sector

You can display AIS targets only within a specific sector. If the target sorting method is selected to [Sector], the target data within the sector set here is transmitted to this radar.

1. Press the **MENU/ESC** key to open the menu.
2. Select [AIS], then press the **ENTER** key.
3. Select [Sector Start], then press the **ENTER** key.
4. Set the start point for the sector, then press the **ENTER** key.
5. Select [Sector End], then press the **ENTER** key.
6. Set the end point for the sector, then press the **ENTER** key.
7. Press the **MENU/ESC** key to close the menu.

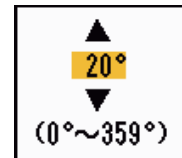
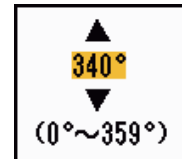

5.8 Number of Targets to Display

You can select the maximum number of AIS targets to display. The setting value is 10 to 100. When the screen becomes cluttered with AIS targets, you can limit the number of AIS targets to show. Targets are selected and displayed according to sort method. (see section 5.5).

1. Press the **MENU/ESC** key to open the menu.
2. Select [AIS], then press the **ENTER** key.
3. Select [Number of Targets], then press the **ENTER** key.
4. Select the number of targets to display, then press the **ENTER** key.
5. Press the **MENU/ESC** key to close the menu.

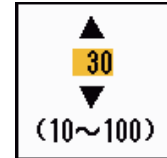

5.9 Vector Attributes

5.9.1 What is a vector?

A vector is a line extending from a tracked target. A vector shows speed and course of the target. The top of a vector shows estimated position of the target after the selected vector time elapses. If you extend the vector length (time), you can evaluate the risk of collision with any target.

5.9.2 Vector time and vector reference

1. Press the **MENU/ESC** key to open the menu.
2. Select [Target], then press the **ENTER** key.
3. Select [Vector Time], then press the **ENTER** key.



4. Select time, then press the **ENTER** key.
5. Select [Vector Reference], then press the **ENTER** key.
6. Select [Relative] or [True] then press the **ENTER** key.

[Relative]: Other ships' vectors are displayed relative to your ship. This mode helps find targets on a collision course. If a ship is on a collision course with your ship, the vector of a ship points toward your ship position.

[True]: Your ship's and other ships' vectors are displayed at their true motions. This mode helps discriminate between moving and stationary targets.
7. Press the **MENU/ESC** key to close the menu.



5.10 Past Position Display (target past position)

This radar can display time-spaced dots (maximum ten dots) that marks the past positions of any tracked AIS target. You can evaluate actions of a target by the spacing between dots. Below are examples of dot spacing and target movement.

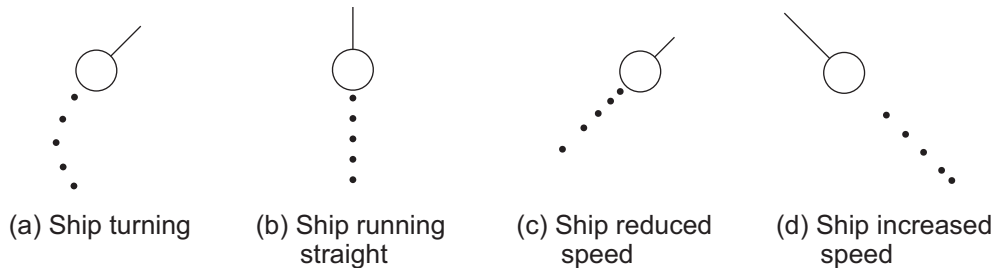

You can select the number of history dots to display and the time interval to display the history dots.

1. Press the **MENU/ESC** key to open the menu.
2. Select [Target], then press the **ENTER** key.
3. Select [Past Positions], then press the **ENTER** key.
4. Select number of past position dots to display (5 or 10) or select [Off] to turn off the past position display.
5. Press the **ENTER** key.
6. Select [Past Posn Interval], then press the **ENTER** key.
7. Select time interval, then press the **ENTER** key.
8. Press the **MENU/ESC** key to close the menu.

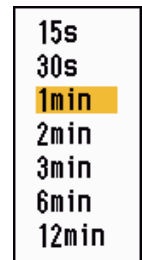

5.11 CPA/TCPA Alarm

Set CPA (Closest Point of Approach) alarm range and TCPA (predicted Time to CPA) alarm time to alert you to targets that can be on a collision course. When CPA and TCPA of any AIS target (including a sleeping target) become less than the preset CPA and TCPA alarm settings, the audio alarm sounds. The alarm message "COLLISION" appears. The target symbol changes to a dangerous target symbol (red) and flashes with its vector. You can stop the audio alarm and flashing with any key. The dangerous target symbol is displayed until the AIS target is not in the CPA and TCPA alarm setting. The AIS continuously monitors CPA and TCPA of all AIS targets.

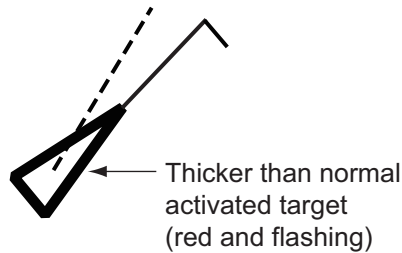

This feature helps identify targets that can be on a collision course.

1. Press the **MENU/ESC** key to open the menu.
2. Select [Target], then press the **ENTER** key.
3. Select [CPA], then press the **ENTER** key.

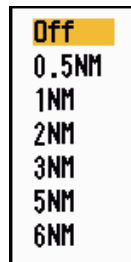

4. Select CPA distance, then press the **ENTER** key.
5. Select [TCPA], then press the **ENTER** key.



6. Select TCPA time, then press the **ENTER** key.
7. Press the **MENU/ESC** key to close the menu.

5.12 Proximity Alarm

The proximity alarm alerts you when an AIS target is within the range you set. The audio alarm sounds and the alarm message "PROXIMITY" appears. The target symbol changes to a dangerous target symbol (red) and flashes with its vector. Press any key to stop the audio alarm and flashing. The dangerous target symbol is displayed until the target is not within the range set, the alarm range is changed to exclude the target, or the proximity alarm is deactivated.

1. Press the **MENU/ESC** key to open the menu.
2. Select [Target], then press the **ENTER** key.
3. Select [Proximity], then press the **ENTER** key.

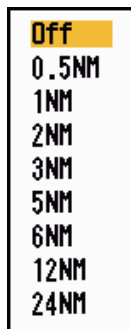

4. Select the range, then press the **ENTER** key.
5. Press the **MENU/ESC** key to close the menu.

5.13 Lost Target

When AIS data is not received from a target at fixed interval (3-5* report intervals), the target symbol changes to the lost target symbol (flashing). No audio or visual alarm is given for a lost target.



* The interval at which AIS data is sent depends on speed of the AIS transponder. For detailed information, refer to the Operator's Manual for the AIS transponder.

You can remove all lost AIS targets from the display as follows:

1. Press the **MENU/ESC** key to open the menu.
2. Select [AIS], then press the **ENTER** key.
3. Select [Erase Lost Targets], then press the **ENTER** key.

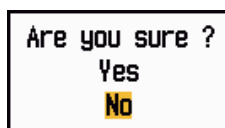

4. Use the Cursorpad (▲) to select [Yes], then press the **ENTER** key. All lost targets symbols are erased from the screen and the long beep sounds.
5. Press the **MENU/ESC** key to close the menu.

5.14 Symbol Color

You can select the AIS symbol color among Green, Red (unavailable in the [IEC] or [Russian-River] purpose), Blue, White or Black.

1. Press the **MENU/ESC** key to open the menu.
2. Select [AIS], then press the **ENTER** key.
3. Select [Color], then press the **ENTER** key.



4. Select the color, then press the **ENTER** key.
5. Press the **MENU/ESC** key to close the menu.

Note: Symbols can not be shown in the same color as the background color.

5.15 How to Ignore Slow Targets

You can prevent activation of the CPA/TCPA alarm against AIS targets that are traveling at a speed lower than set here. The AIS symbols are not affected by this setting.

1. Press the **MENU/ESC** key to open the menu.
2. Select [AIS], then press the **ENTER** key.
3. Select [Ignore Slow Targets], then press the **ENTER** key.

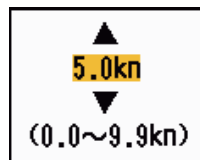

4. Set speed (0.0 - 9.9 kn), then press the **ENTER** key.
5. Press the **MENU/ESC** key to close the menu.

6. GPS OPERATION

If the FURUNO GPS Navigator GP-320B is connected to this radar, you can set GP-320B from this radar.

6.1 Navigator Mode

1. Press the **MENU/ESC** key to open the menu.
2. Select [GPS], then press the **ENTER** key.
3. Select [Mode], then press the **ENTER** key.
4. Select [GPS] or [WAAS] then press the **ENTER** key.
5. Press the **MENU/ESC** key to close the menu.



6.2 Datum

Select the type of datum which matches the paper charts you use for navigation. Select [WGS-84] if the radar is connected to an AIS Transponder.

1. Press the **MENU/ESC** key to open the menu.
2. Select [GPS], then press the **ENTER** key.
3. Select [Datum], then press the **ENTER** key.
4. Select the type of datum, then press the **ENTER** key. If you selected [WGS-84] or [Tokyo], go to step 7. For [Other], go to the next step.
5. Select [Datum Number], then press the **ENTER** key.
6. Select the datum number, then press the **ENTER** key. (See Appendix 2.)
7. Press the **MENU/ESC** key to close the menu.

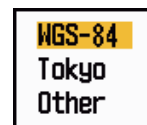

6.3 WAAS Setup

Geostationary satellites, the type used with WAAS, provide more accurate position data when compared to GPS. These satellites can be tracked automatically or manually. Auto tracking automatically searches for the best geostationary satellite from your current position.

1. Press the **MENU/ESC** key to open the menu.
2. Select [GPS], then press the **ENTER** key.
3. Select [WAAS], then press the **ENTER** key.
4. Select [Auto] or [Manual] then press the **ENTER** key. If you selected [Auto], go to step 7. For [Manual], go to the next step.
5. Select [WAAS No], then press the **ENTER** key.
6. Select WAAS number, then press the **ENTER** key. (The setting range is 120 - 158. Refer to the following table.)
7. Press the **MENU/ESC** key to close the menu.



Provider	Satellite type	Longitude	Satellite No.
WAAS	Inmarsat-3-F4 (AOR-W)	142°W	122
	Inmarsat-3-F3 (POR)	178°E	134
	Intelsat Galaxy XV	133°W	135
	TeleSat Anik F1R	107.3°W	138
EGNOS	Inmarsat-3-F2 (AOR-E)	15.5°W	120
	Artemis	21.5°E	124
	Inmarsat-3-F5 (IOR-W)	25°E	126
MSAS	MTSAT-1R	140°E	129
	MTSAT-2	145°E	137

6.4 Satellite Monitor

The Satellite Monitor provides the information about GPS and WAAS satellites. See your GPS navigator's owner's manual for detailed information.

1. Press the **MENU/ESC** key to open the menu.
2. Select [GPS], then press the **ENTER** key.
3. Select [Satellite Monitor], then press the **ENTER** key.

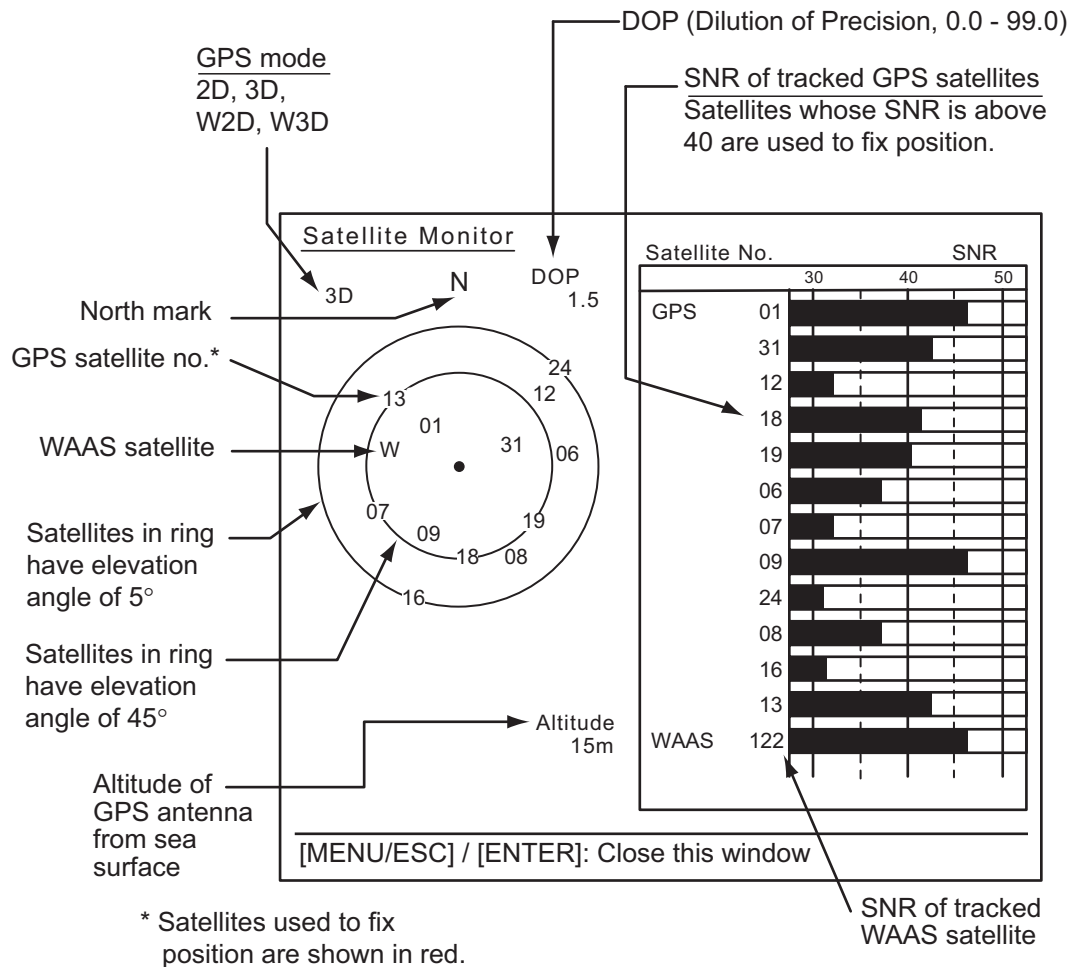

4. Press the **ENTER** key to close only the satellite monitor display.

6.5 Self Test

1. Press the **MENU/ESC** key to open the menu.
2. Select [GPS], then press the **ENTER** key.
3. Select [Self Test], then press the **ENTER** key.

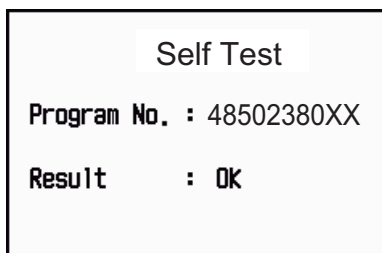

XX: Program No.
(Program No. subject to change depending on GPS Navigator.)

Self Test display

[**Program No.**]: 10 digit number

[**Result**]: The result of the test, [OK] or [NG] (No Good). If NG appears, try the self test again. If it appears again, contact your dealer for advice.

4. Press the **MENU/ESC** key to close the menu.

6.6 Cold Start

Cold start, which clears the Almanac from the GPS receiver, should be done in the following conditions:

- The GPS receiver has not been powered for a long time.
- The ship has moved far away from the previous fixing position (e.g., more than 500 km).
- Other reason that prevents the receiver from finding its position within five minutes after you turn on the power.



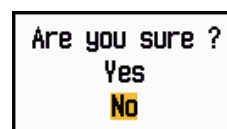

To do cold start, do the following:

1. Press the **MENU/ESC** key to open the menu.
2. Select [GPS], then press the **ENTER** key.
3. Select [Cold Start], then press the **ENTER** key.
4. Use the Cursorpad (**▲**) to select [Yes], then press the **ENTER** key. A long beep sounds at the completion of the cold start. (To stop cold start, press the **MENU/ESC** key instead of the **ENTER** key.)
5. Press the **MENU/ESC** key to close the menu.



7. MAINTENANCE, TROUBLE-SHOOTING

This chapter has information about maintenance and troubleshooting that the user can follow to care for the equipment.

 WARNING	
	ELECTRICAL SHOCK HAZARD Do not open the equipment. Only qualified personnel can work inside the equipment.
	Turn off the power before you service the antenna unit. Post a warning sign near the power switch indicating that the power should be left off while you are servicing the antenna unit.
	Prevent the potential risk of being struck by the rotating antenna and exposure to RF radiation hazard.
	When you work on the antenna unit, wear a safety belt and hard hat. Serious injury or death can result if a person falls from the radar antenna mast.

NOTICE
Do not apply paint, anti-corrosive sealant or contact spray to plastic parts or equipment coating. Those items contain products that can damage plastic parts and equipment coating.

7.1 Preventive Maintenance

Regular maintenance helps keep your equipment in good condition and prevents future problems. Check the items shown in the table below to help keep your equipment in good condition for years to come.

Maintenance

Interval	Item	Check point	Remedy
When necessary	LCD	Dust on the LCD	Remove the dust from the LCD with the tissue paper and an LCD cleaner. To remove dirt or salt, use the LCD cleaner. Change the tissue paper often so as not to scratch the LCD.
3 to 6 months	Ground terminal on display unit	Check for tight connection and rust.	Tighten or replace as necessary.
	Display unit connectors	Check for tight connection.	Tighten if the connectors are loosened.
	Exposed nuts and bolts on the antenna unit	Check for corroded or loosened bolts.	Clean and repaint as necessary. Use sealing compound instead of paint.
	Antenna radiator	Check for dirt and cracks on the radiator surface.	Clean radiator surface with freshwater-moistened cloth. Do not use plastic solvents to clean.

7.2 Fuse Replacement

The fuse on the power cable protects the equipment from overcurrent and equipment fault. If the fuse blows, find the cause before you replace the fuse. Use the correct fuse. A wrong fuse can damage the equipment. If the fuse blows again, contact your dealer for advice.

WARNING

Use the correct fuse.

A wrong fuse can damage the equipment and cause fire.

Type	Code No.	Remarks
FRU-2P5S-FU-5A-B	000-168-869-10	12-24 VDC

7.3 Magnetron Life

The life expectancy of the magnetron is approx. 5,000 hours. The performance of a magnetron decreases over time, causing lower-than-normal signal strength and loss of echoes. If you feel the signal strength is low, contact your dealer about replacement of the magnetron.

Part	Type	Code No.	Estimated life
Magnetron	E3571	000-146-867-11	Approx. 5,000 hours

7.4 Simple Troubleshooting

This section provides simple troubleshooting procedures which the user can follow to restore normal operation. If you cannot restore normal operation, do not check inside the unit. Have a qualified technician check the equipment.

Simple troubleshooting

Problem	Remedy
You cannot turn on the power.	<ul style="list-style-type: none"> • Check for blown fuse. • Check that the power connector is fastened. • Check for corrosion on the power cable connector. • Check for damaged power cable. • Check battery for correct voltage output.
There is no response when a key is pressed.	Turn the power off and on, then try operating the key again. If you do not get a response, the key is damaged. Contact your dealer for instructions.
Nothing displayed after pressing  key.	<ul style="list-style-type: none"> • Check that the antenna cable is fastened. • Check if correct radar source is set.
The power is on and you operated the power key to transmit. The marks and characters appear, but no echoes appear.	Check that the antenna cable is fastened.
Tuning is correctly adjusted, but sensitivity is poor.	The magnetron may be faulty. Contact your dealer about replacement of the magnetron.
Displayed image stops and does not update.	<ul style="list-style-type: none"> • Check that the antenna cable is fastened. • Reboot the display unit.
You can change the range, but the radar picture does not change.	Reset the power.
Poor discrimination in range because of many echoes from waves.	Adjust the sea clutter.
The true motion presentation is not working correctly.	<ul style="list-style-type: none"> • Check that the setting of [Display Mode] in the [Display] menu is set to [True Motion]. • Check if the heading and position data are input and correct.
The range rings are not displayed.	Check that the setting of [Rings Brill] in the [Brill/Color] menu is set to other than [Off].

Problem	Remedy
Target is not tracked correctly because of sea clutter.	Adjust the sea clutter and rain clutter.
After switching to transmit (TX), the system switches back to stand-by (STBY).	<ul style="list-style-type: none"> • Check that the antenna cable is fastened. • Turn off the power, wait for a few seconds and reboot.

7.5 Advanced-level Troubleshooting

This section provides hardware and software troubleshooting procedures for the qualified serviceman.

Advanced-level troubleshooting

Problem	Probable cause or check points	Remedy
Power cannot be turned on.	<ol style="list-style-type: none"> 1) Mains voltage/polarity 2) Power supply board 	<ol style="list-style-type: none"> 1) Correct the wiring and input voltage. 2) Replace power supply board.
Brilliance adjusted but no picture.	<ol style="list-style-type: none"> 1) MAIN Board 	<ol style="list-style-type: none"> 1) Replace the MAIN board.
Antenna not rotating.	<ol style="list-style-type: none"> 1) Antenna drive mechanism 	<ol style="list-style-type: none"> 1) Replace the antenna drive mechanism.
Gain is maximum and sea clutter is minimum. Marks and indications appear but no noise or echo.	<ol style="list-style-type: none"> 1) Signal cable between antenna and display unit 2) IF-SPU Board 	<ol style="list-style-type: none"> 1) Check continuity and isolation of coaxial cable. 2) Replace IF-SPU Board. Check coax line MIC and IF-SPU board for tight connection. If connection is good, replace IF-SPU board.
Marks, indications and noise appear but echoes do not. (Own ship is not shown.)	<ol style="list-style-type: none"> 1) Magnetron 2) MD-PWR Board 3) IF-SPU Board 	<ol style="list-style-type: none"> 1) Select max. range, then check magnetron current. If current is below rated value, replace magnetron. 2) Replace MD-PWR Board. 3) Replace IF-SPU board.
The picture has "frozen".	<ol style="list-style-type: none"> 1) Heading sensor inside antenna unit 2) MAIN board 	<ol style="list-style-type: none"> 1) Check connection between IF-SPU board and heading sensor. 2) Replace MAIN board. 3) Turn radar off and on.
Radar is correctly tuned but sensitivity is poor.	<ol style="list-style-type: none"> 1) Dirt on radiator face 2) Deteriorated magnetron 3) Detuned MIC 	<ol style="list-style-type: none"> 1) Clean the radiator. 2) Check the magnetron current with radar on max. range. If the current is below normal, magnetron may be defective. Replace the magnetron. 3) Restore default tuning. Replace MIC.
Range picture does not change when range is changed.	<ol style="list-style-type: none"> 1) MAIN Board 2) SPU board 	<ol style="list-style-type: none"> 1) Replace MAIN Board. 2) Turn radar off and on.

Problem	Probable cause or check points	Remedy
Range rings are not displayed.	1) Adjust their brilliance on the [Brill/Color] menu. 2) MAIN Board	1) Replace associated circuit board if unsuccessful. 2) Replace MAIN Board.

7.6 Self Test

The self test checks the system for correct operation. This test is for use by service technicians, but the user can do this test to provide the service technician with information.

1. Press the **MENU/ESC** key to open the menu.
2. Select [Tests], then press the **ENTER** key.
3. Select [Self Test], then press the **ENTER** key.

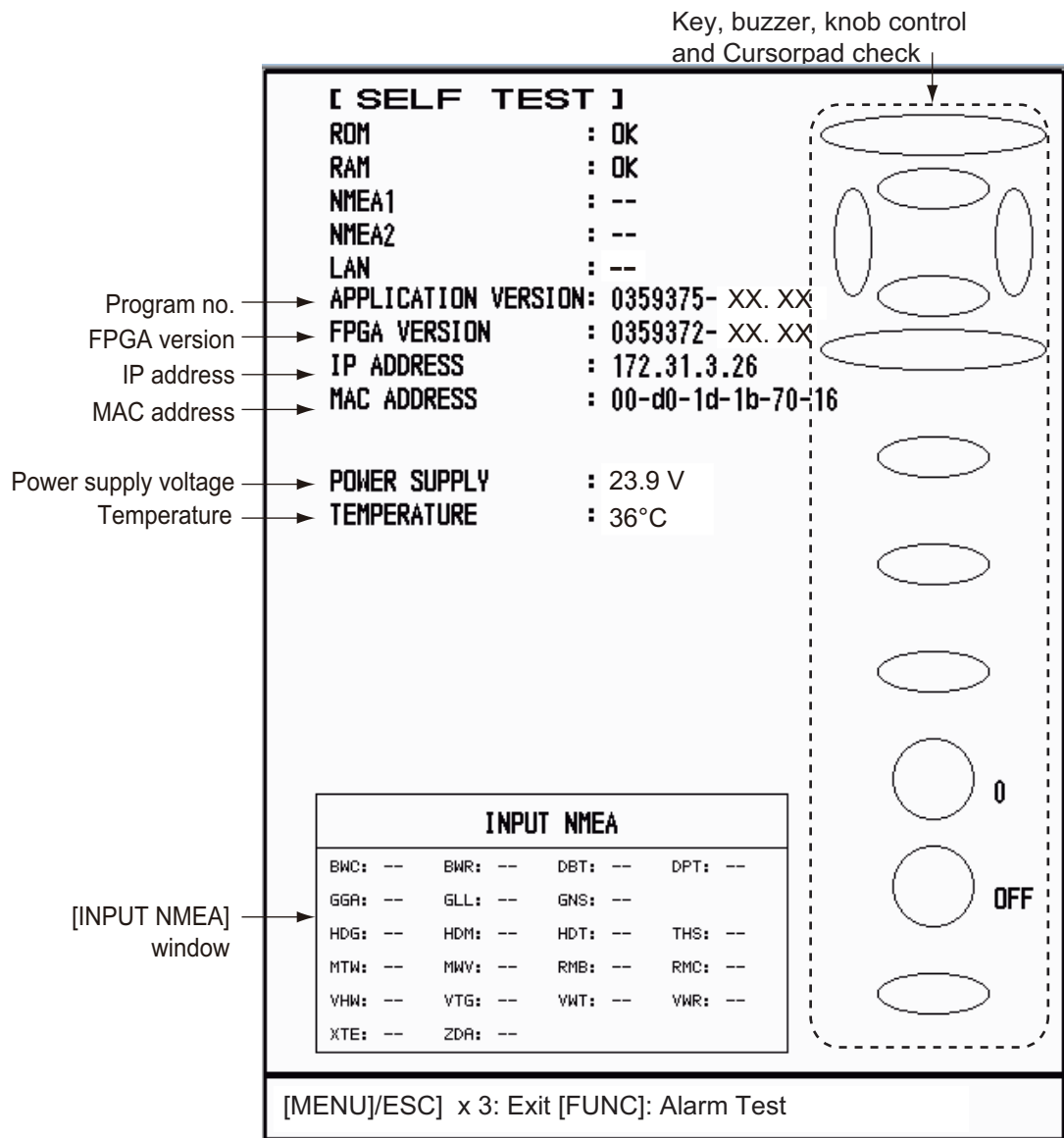

XX.XX: Program version no.

Test results

- [ROM], [RAM]: The results of the ROM and RAM test are displayed as [OK] or [NG] (No Good).
- [LAN]: The results of the LAN test are displayed as [OK] or [--]. This test requires a special checker. [--] indicates the checker is not connected.
- [NMEA1], [NMEA2]: The results of the ports NMEA1 and NMEA2 are displayed as OK or [--]. Ports NMEA1 and NMEA2 require a special connector to test them. [--] appears when the connector is not connected. If [--] appears when the connector is connected, contact your dealer for advice.
- [APPLICATION VERSION], [FPGA VERSION]: The program numbers and program version numbers (XX.XX) are displayed.
- [TEMPERATURE]: Temperature of the equipment is shown.
- [INPUT NMEA] window: The state of all the NMEA sentences being input to this radar is shown as OK or "- -". ("- -". ("- -". ("- -" indicates no input.) Sentences are updated every second.

Key check

Press each key one by one. A key's on-screen location becomes green if the key is normal.

Cursorpad check

Press each arrow on the Cursorpad one by one. The on-screen location is colored green if the pressed arrow is normal.

Buzzer check

Press the **FUNC** key to test the panel buzzer or external buzzer. To stop the buzzer, press the **FUNC** key again.

Knob control check

Rotate each control knob. The digit (0 to 100) to the right of the control icon increments or decrements with control operation. Push each knob. The knob corresponding on-screen circle changes in green if the knob is normal.

Data display check

Rotate the **DATA BOX** knob. The display shows [OFF], [NAV], [TGT] or [ALL] at each control position.

4. Press the **MENU/ESC** key three times to close the test results.
5. Press the **MENU/ESC** key to close the menu.

7.7 LCD Test

1. Press the **MENU/ESC** key to open the menu.
2. Select [Tests], then press the **ENTER** key.
3. Select [LCD Test], then press the **ENTER** key.

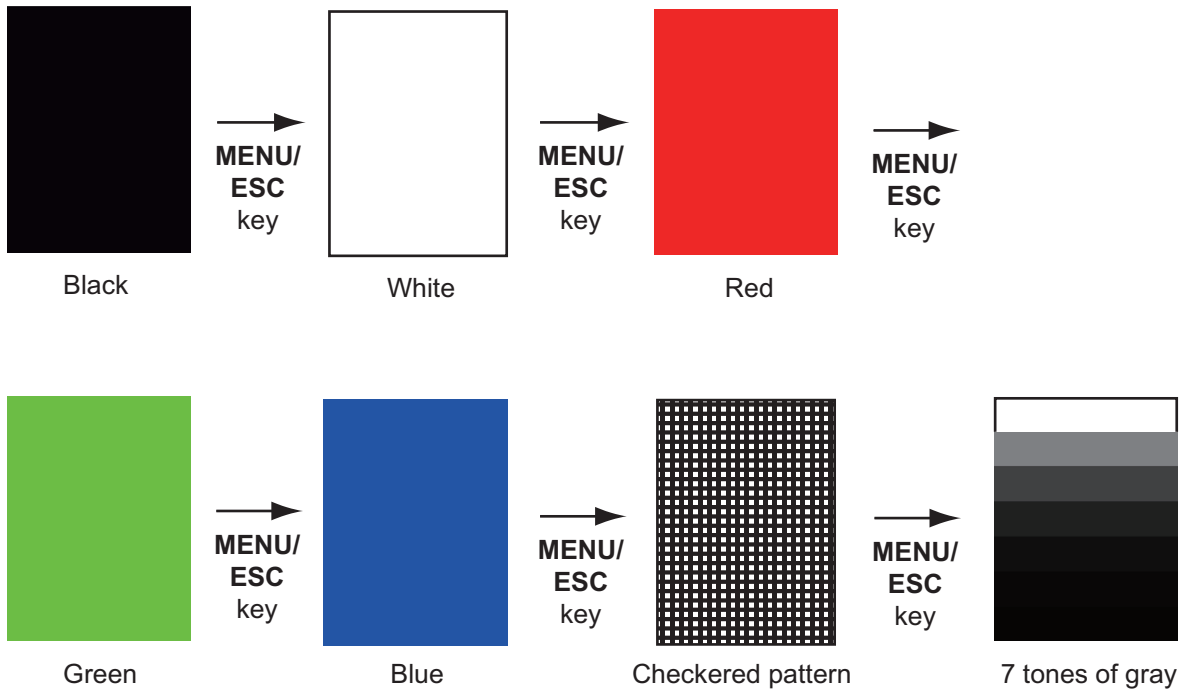

4. Press the **MENU/ESC** key several times to close the menu.

Note: You can adjust the screen brilliance with the  key during the test.

7.8 Radar Sensor Test

This test checks the antenna unit (RSB-127-120) for proper operation.

1. Press the **MENU/ESC** key to open the menu.
2. Select [Tests], then press the **ENTER** key.
3. Select [Radar Sensor Test], then press the **ENTER** key.

```

[ RADAR SENSOR TEST ]
BOOTER VERSION      : 0359366- XX. XX
APPLICATION VERSION: 0359367- XX. XX
FPGA VERSION       : 0359368- XX. XX
IP ADDRESS         : 172. 31. 3. 27
MAC ADDRESS        : 00-d0-1d-0f-ac-79
ROM                : OK
RAM                : OK
TX-HV              : 349.7 V
5V                 : 5.0 V
12V                : 12.4 V
ANTENNA STATUS     : OK
HEADING PULSE      : OK
TX TRIGGER         : OK
VIDEO STATUS       : OK
ANTENNA ROTATION   : 23.8 rpm
TUNING VOLTAGE     : 5.0 V
TUNE INDICATOR     : 7
TOTAL ON TIME      : 3.7 H
TOTAL TX TIME      : 1.3 H
MAGNETRON MONITOR  : 0.3 V

TT ECHO            : 0
TT LAND ECHO       : 0

[MENU/ESC]: Exit

```

XX: Program no.

4. Press the **MENU/ESC** key three times to close the test screen.

APPENDIX 1 MENU TREE

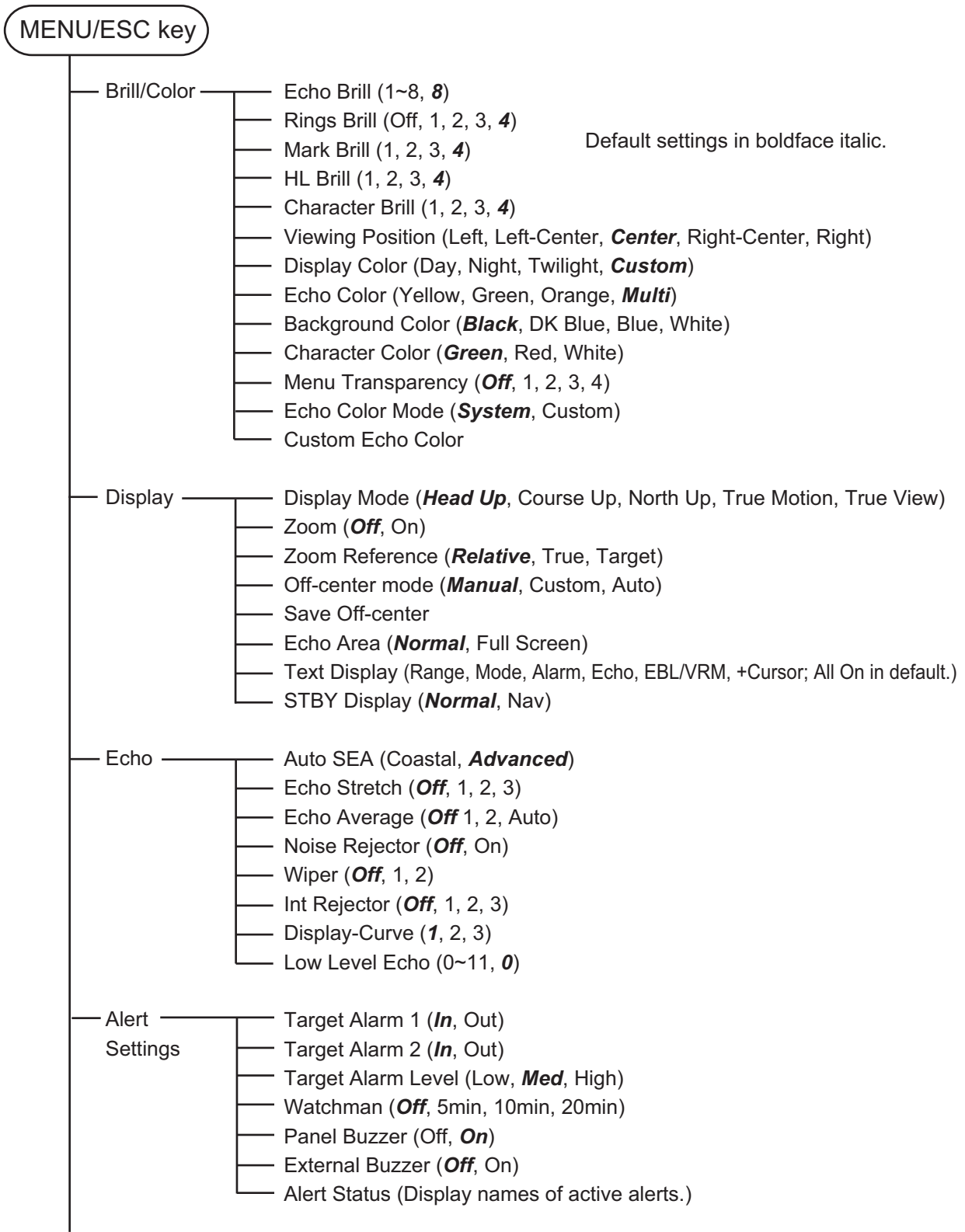

(Continued on next page)

APPENDIX 1 MENU TREE

(Continued from previous page)

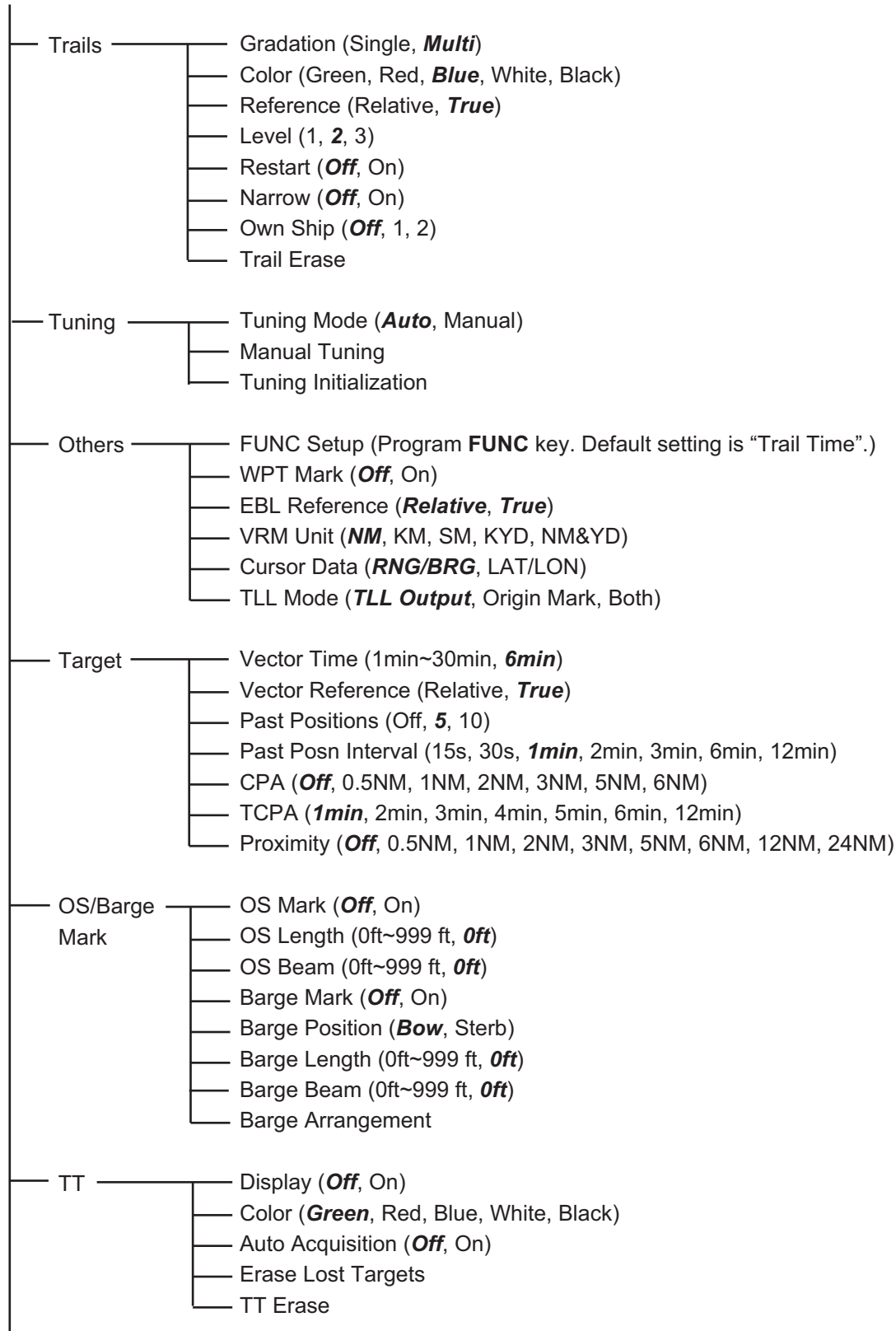

(Continued on next page)

(Continued from previous page)

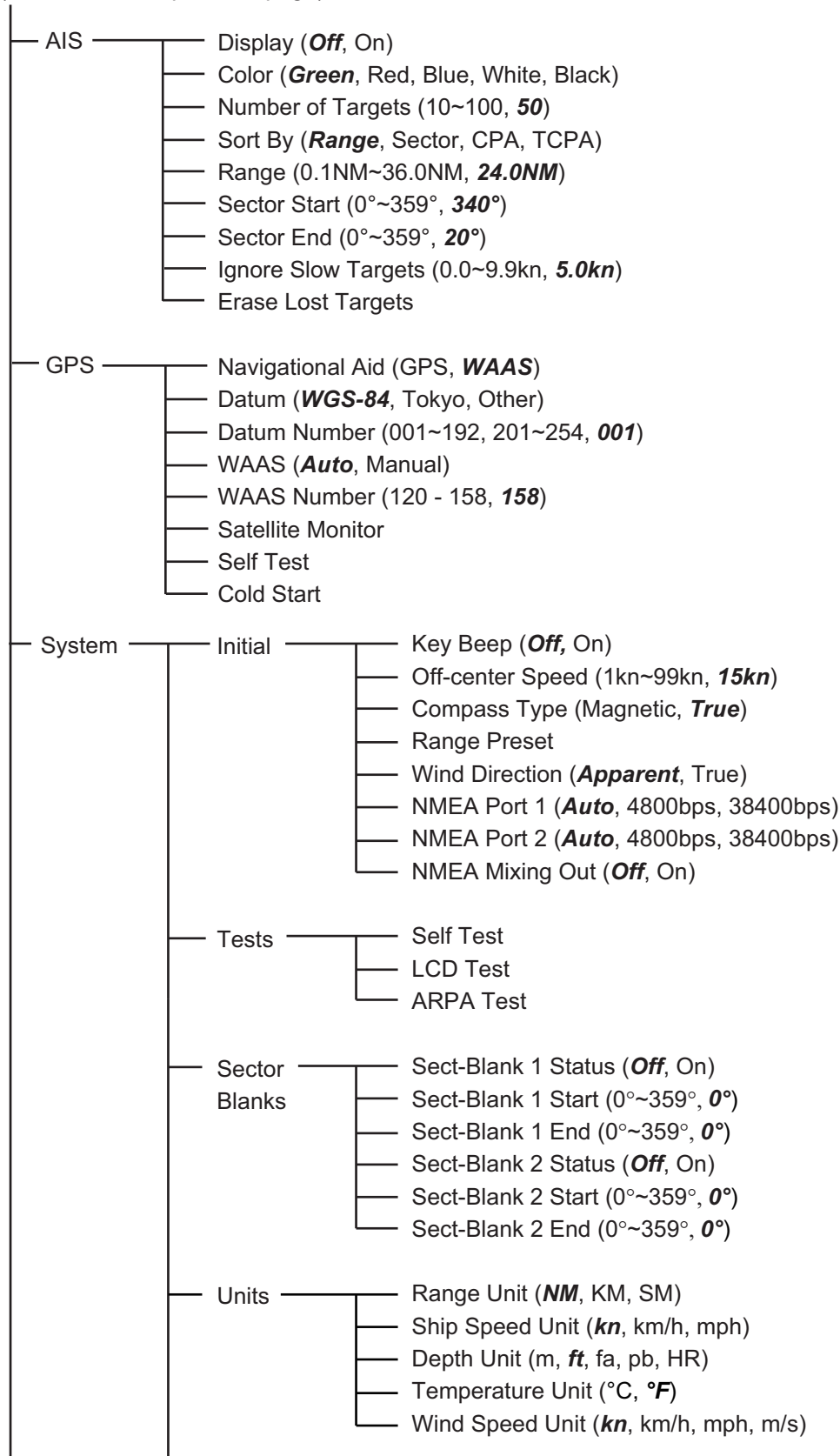

(Continued on next page)

APPENDIX 1 MENU TREE

(Continued from previous page)

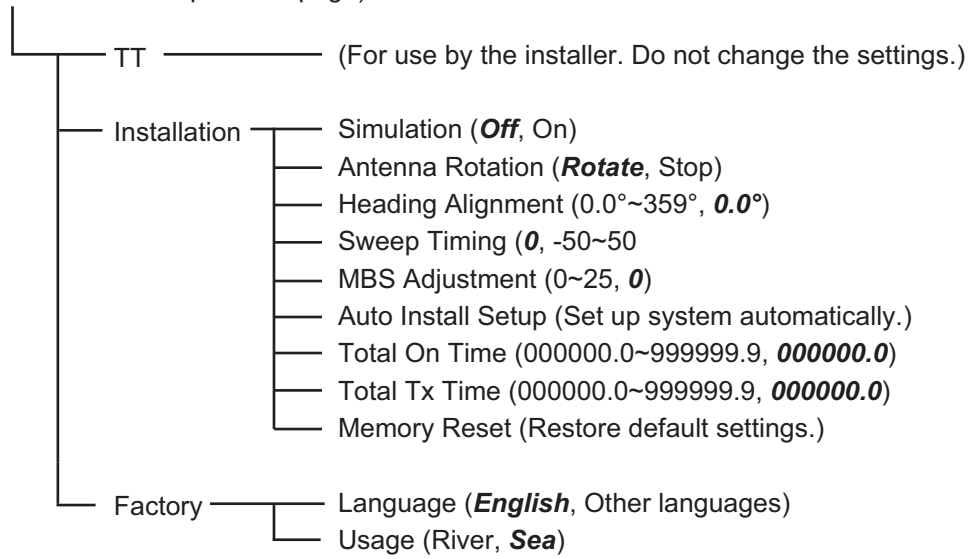

APPENDIX 2 GEODETIC CHART LIST

001: WGS84		
002: WGS72		
003: TOKYO	: Mean Value (Japan, Korea & Okinawa)	
004: NORTH AMERICAN 1927	: Mean Value (CONUS)	
005: EUROPEAN 1950	: Mean Value	
006: AUSTRALIAN GEODETIC 1984	: Australia & Tasmania	
007: ADINDAN-MN	: Mean Value (Ethiopia & Sudan)	
008: ADINDAN-E	: Ethiopia	
009: ADINDAN-MA	: Mali	
010: ADINDAN-SE	: Senegal	
011: ADINDAN-SU	: Sudan	
012: AFG	: Somalia	
013: AIN EL ABD 1970	: Bahrain Is.	
014: ANNA 1 ASTRO 1965	: Cocos Is.	
015: ARC 1950-MN	: Mean Value	
016: ARC 1950-B	: Botswana	
017: ARC 1950-L	: Lesotho	
018: ARC 1950-M	: Malawi	
019: ARC 1950-S	: Swaziland	
020: ARC 1950-ZR	: Zaire	
021: ARC 1950-ZM	: Zambia	
022: ARC 1950-ZB	: Zimbabwe	
023: ARC 1960-MN	: Mean Value (Kenya & Tanzania)	
024: ARC 1960-K	: Kenya	
025: ARC 1960-T	: Tanzania	
026: ASCENSION IS. 1958	: Ascension Is.	
027: ASTRO BEACON "E"	: Iwo Jima Is.	
028: ASTRO B4 SOR. ATOLL	: Tern Is.	
029: ASTRO POS 71/4	: St. Helena Is.	
030: ASTRONOMIC STATION 1952	: Marcus Is.	
031: AUSTRALIAN GEODETIC 1966	: Australia & Tasmania	
032: BELLEVUE (IGN)	: Efate & Erromango Is.	
033: BERMUDA 1957	: Bermuda Is.	
034: BOGOTA OBSERVATORY	: Columbia	
035: CAMPO INCHAUSPE	: Argentina	
036: CANTON IS. 1966	: Phoenix Is.	
037: CAPE	: South Africa	
038: CAPE CANAVERAL	: Mean Value (Florida & Bahama Is.)	
039: CARTHAGE	: Tunisia	
040: CHATHAM 1971	: Chatham Is. (New Zealand)	
041: CHUUA ASTRO	: Paraguay	
042: CORREGO ALEGRE	: Brazil	
043: DJAKARTA (BATAVIA)	: Sumatra Is. (Indonesia)	
044: DOS 1968	: Gizo Is. (New Georgia Is.)	
045: EASTER IS. 1967	: Easter Is.	
046: EUROPEAN 1950-WE	: Western Europe	
047: EUROPEAN 1950-CY	: Cyprus	
048: EUROPEAN 1950-EG	: Egypt	
049: EUROPEAN 1950-ESC	: England, Scotland, Channel & Shetland Is.	
050: EUROPEAN 1950-EIS	: England, Ireland, Scotland & Shetland Is.	
051: EUROPEAN 1950-GR	: Greece	
052: EUROPEAN 1950-IR	: Iran	
053: EUROPEAN 1950-SA	: Italy, Sardinia	
054: EUROPEAN 1950-SI	: Italy, Sicily	
055: EUROPEAN 1950-NF	: Norway & Finland	
056: EUROPEAN 1950-PS	: Portugal & Spain	
057: EUROPEAN 1979	: Mean Value	
058: GANDAJIKA BASE	: Republic of Maldives	
059: GEODETIC DATUM 1949	: New Zealand	
060: GUAM 1963	: Guam Is.	
061: GUX 1 ASTRO	: Guadalcanal Is.	
062: HJORSEY 1955	: Iceland	
063: HONG KONG 1963	: Hong Kong	
064: INDIAN-TV	: Thailand & Vietnam	
065: INDIAN-BIN	: Bangladesh, India & Nepal	
066: IRELAND 1965	: Ireland	
067: ISTS 073 ASTRO 1969	: Diego Garcia	
068: JOHNSTON IS. 1961	: Johnston Is.	
069: KANDAWALA	: Sri Lanka	
070: KERGUELEN IS.	: Kerguelen Is.	
071: KERTAU 1948	: West Malaysia & Singapore	
072: LA REUNION	: Mascarene Is.	
073: L. C. 5 ASTRO	: Cayman Brac Is.	
074: LIBERIA 1964	: Liberia	
075: LUZON	: Philippines (excl. Mindanao Is.)	
076: LUZON-M	: Mindanao Is.	
077: MAHE 1971	: Mahe Is.	
078: MARCO ASTRO	: Salvage Islands	
079: MASSAWA	: Eritrea (Ethiopia)	
080: MERCHICH	: Morocco	
081: MIDWAY ASTRO 1961	: Midway Is.	
082: MINNA	: Nigeria	
083: NAHRWAN-O	: Masirah Is. (Oman)	
084: NAHRWAN-UAE	: United Arab Emirates	
085: NAHRWAN-SA	: Saudi Arabia	
086: NAMIBIA	: Namibia	
087: MAPARIMA, BWI	: Trinidad & Tobago	
088: NORTH AMERICAN 1927WU	: Western United States	
089: NORTH AMERICAN 1927EU	: Eastern United States	
090: NORTH AMERICAN 1927AK	: Alaska	
091: NORTH AMERICAN 1927BH	: Bahamas (excl. San Salvador Is.)	
092: NORTH AMERICAN 1927SS	: Bahamas, San Salvador Is.	
093: NORTH AMERICAN 1927CN	: Canada (incl. Newfoundland Is.)	
094: NORTH AMERICAN 1927AB	: Alberta & British Columbia	
095: NORTH AMERICAN 1927EC	: East Canada	
096: NORTH AMERICAN 1927MO	: Manitoba & Ontario	
097: NORTH AMERICAN 1927NE	: Northwest Territories & Saskatchewan	
098: NORTH AMERICAN 1927YK	: Yukon	
099: NORTH AMERICAN 1927CZ	: Canal Zone	
100: NORTH AMERICAN 1927CR	: Caribbean	
101: NORTH AMERICAN 1927CA	: Central America	
102: NORTH AMERICAN 1927CU	: Cuba	
103: NORTH AMERICAN 1927GR	: Greenland	
104: NORTH AMERICAN 1927MX	: Mexico	
105: NORTH AMERICAN 1983AK	: Alaska	
106: NORTH AMERICAN 1983CN	: Canada	
107: NORTH AMERICAN 1983CS	: CONUS	
108: NORTH AMERICAN 1983MX	: Mexico, Central America	
109: OBSERVATORIO 1966	: Corvo & Flores Is. (Azores)	
110: OLD EGYPTIAN 1930	: Egypt	
111: OLD HAWAIIAN-MN	: Mean Value	
112: OLD HAWAIIAN-HW	: Hawaii	
113: OLD HAWAIIAN-KA	: Kauai	
114: OLD HAWAIIAN-MA	: Maui	
115: OLD HAWAIIAN-OA	: Oahu	
116: OMAN	: Oman	
117: ORDNANCE SURVEY OF GREAT BRITAIN 1936-NM	: Mean Value	
118: ORDNANCE SURVEY OF GREAT BRITAIN 1936-E	: England	
119: ORDNANCE SURVEY OF GREAT BRITAIN 1936-IM	: England, Isle of Man & Wales	
120: ORDNANCE SURVEY OF GREAT BRITAIN 1936-SSI	: Scotland & Shetland Is.	
121: ORDNANCE SURVEY OF GREAT BRITAIN 1936-WL	: Wales	
122: PICO DE LAS NIVIAS	: Canary Is.	
123: PITCAIRN ASTRO 1967	: Pitcairn Is.	
124: PROVISIONS SOUTH CHILEAN 1963: South Chile (near 53°S)		
125: PROVISIONAL SOUTH AMERICAN 1956MN: Mean Value		
126: PROVISIONAL SOUTH AMERICAN 1956BO: Bolivia		
127: PROVISIONAL SOUTH AMERICAN 1956NC: Chile-Northern Chile (near 19°S)		
128: PROVISIONAL SOUTH AMERICAN 1956SC: Chile-Southern Chile (near 43°S)		
129: PROVISIONAL SOUTH AMERICAN 1956CO: Columbia		
130: PROVISIONAL SOUTH AMERICAN 1956EC: Ecuador		
131: PROVISIONAL SOUTH AMERICAN 1956GY: Guyana		
132: PROVISIONAL SOUTH AMERICAN 1956PR: Peru		
133: PROVISIONAL SOUTH AMERICAN 1956VN: Venezuela		
134: PUERTO RICO	: Puerto Rico & Virgin Is.	
135: QATAR NATIONAL	: Qatar	
136: QORNOQ	: South Greenland	
137: ROME 1940	: Sardinia Is.	
138: SANTA BRAZ	: Sao Miguel, Santa Maria Is. (Azores)	
139: SANTO (DOS)	: Espirito Santo Is.	
140: SAPPER HILL 1943	: East Falkland Is.	
141: SOUTH AMERICAN 1969MN	: Mean Value	
142: SOUTH AMERICAN 1969AG	: Argentina	
143: SOUTH AMERICAN 1969BO	: Bolivia	
144: SOUTH AMERICAN 1969BR	: Brazil	
145: SOUTH AMERICAN 1969CH	: Chile	
146: SOUTH AMERICAN 1969CO	: Columbia	
147: SOUTH AMERICAN 1969EC	: Ecuador	
148: SOUTH AMERICAN 1969GY	: Guyana	
149: SOUTH AMERICAN 1969PA	: Paraguay	
150: SOUTH AMERICAN 1969PR	: Peru	
151: SOUTH AMERICAN 1969TT	: Trinidad & Tobago	
152: SOUTH AMERICAN 1969VZ	: Venezuela	
153: SOUTH ASIA	: Singapore	
154: SOUTHEAST BASE	: Porto Santo & Madeira Is.	
155: SOUTHWEST BASE	: Faial, Graciosa, Pico, Sao Jorge & Terceira Is.	
156: TIMBALAI 1948	: Brunei & East Malaysia (Sarawak & Sabah)	
157: TOKYO JP	: Japan	
158: TOKYO KP	: Korea	
159: TOKYO OK	: Okinawa	
160: TRISTAN ASTRO 1968	: Tristan da Cunha	
161: VITI LEVU 1916	: Viti Levu Is. (Fiji Is.)	
162: WAKE-ENIWETOK 1960	: Marshall Is.	
163: ZANDERIJ	: Surinam	
164: BUKIT RIMPAH	: Bangka & Belitung Is. (Indonesia)	
165: CAMP AREA ASTRO	: Camp Mcmurdo Area, Antarctica	
166: G. SEGARA	: Kalimantan Is. (Indonesia)	
167: HERAT NORTH	: Afghanistan	
168: HU-TZU-SHAN	: Taiwan	
169: TANANARIVE OBSERVATORY 1925	: Madagascar	
170: YACARE	: Uruguay	
171: RT-90	: Sweden	
172: TOKYO	: Mean Value (Japan, Korea & Okinawa)	
173: AIN EL ABD 1970	: Bahrain Is.	
174: ARC 1960	: Mean Value (Kenya, Tanzania)	
175: ARS-A	: Kenya	

APPENDIX 2 GEODETIC CHART LIST

176: ARS-B	: Tanzania	221: INDIAN 1960	: Con Son Is. (Vietnam)
177: ASCENSION IS. 1958	: Ascension Is.	222: INDIAN 1975	: Thailand
178: CAPE CANAVERAL	: Mean Value (Florida & Bahama Is.)	223: INDONESIAN 1974	: Indonesia
179: EASTER IS. 1967	: Easter Is.	224: CO-ORDINATE SYSTEM 1937 OF ESTONIA	: Estonia
180: EUROPEAN 1950	: Portugal & Spain	225: EUROPEAN 1950	: Malta
181: JHONSTON IS. 1961	: Jhonston Is.	226: EUROPEAN 1950	: Tunisia
182: NAHRWAN	: Saudi Arabia	227: S-42 (PULKOVO 1942)	: Hungary
183: NAPARIMA, BWI	: Trinidad & Tobago	228: S-42 (PULKOVO 1942)	: Poland
184: NORTH AMERICAN 1927	: Caribbeen	229: S-42 (PULKOVO 1942)	: Czechoslovakia
185: OLD HAWAIIAN	: Oahu	230: S-42 (PULKOVO 1942)	: Latvia
186: SAPPER HILL 1943	: East Falkland Is.	231: S-42 (PULKOVO 1942)	: Kazakhstan
187: TIMBALAI 1948	: Brunei & East Malaysia (Sarawak & Sabah)	232: S-42 (PULKOVO 1942)	: Albania
188: TOKYO	: Japan	233: S-42 (PULKOVO 1942)	: Romenia
189: TOKYO	: South Korea	234: S-JTSK	: Czechoslovakia
190: TOKYO	: Okinawa	235: NORTH AMERICAN 1927	: East of 180W
191: WAKE-ENIWETOK 1960	: Marshall Is.	236: NORTH AMERICAN 1927	: West of 180W
192: HU-TZU-SHAN	: Taiwan	237: NORTH AMERICAN 1983	: Aleutian Is.
201: ADINDAN	: Burkina Faso	238: NORTH AMERICAN 1983	: Hawaii
202: ADINDAN	: Cameroon	239: SOUTH AMERICAN 1969	: Baltra, Galapagos Is.
203: ARC 1950	: Burundi	240: ANTIGUA IS. ASTRO 1943	: Antigua, Leeward Is.
204: AYABELLE LIGHTHOUSE	: Djibouti	241: DECEPTION IS.	: Deception Is., Antarctica
205: BISSAU	: Guinea-Bissau	242: FORT THOMAS 1955	: Nevis, St. Kitts, Leeward Is.
206: DABOLA	: Guinea	243: ISTS 061 ASTRO 1968	: South Georgia Is.
207: EUROPEAN 1950	: Tunisia	244: MONTSERRAT IS. ASTRO 1958	: Montserrat, Leeward Is.
208: LEIGON	: Ghana	245: FEUNION	: Mascarene Is.
209: MINNA	: Cameroon	246: AMERICAN SAMOA 1962	: American Samoa Is.
210: M'PORALOKO	: Gebon	247: INDONESIAN 1974	: Indonesia
211: NORTH SAHARA 1959	: Algeria	248: KUSAIE ASTRO 1951	: Caroline Is., Fed. States of Micronesia
212: POINT58	: Mean Solution (Burkina Faso & Niger)	249: WAKE Is. ASTRO 1952	: Wake Atoll
213: POINTE NOIRE 1948	: Congo	250: EUROPEAN 1950	: Iraq, Israel, Jordan, Kuwait, Lebanon, Saudi Arabia, and Syria
214: SIERRA LEONE 1960	: Sierra Leone	251: HERMANNSKOGEL	: Yugoslavia (Prior to 1990) Slovenia, Croatia, Bosnia and Herzegovina, Serbia
215: VOIROL 1960	: Algeria	252: INDIAN	: Pakistan
216: AIN EL ABD 1970	: Saudi Arabia	253: PULKOVO 1942	: Russia
217: INDIAN	: Bangladesh	254: VOIROL 1874	: Tunisia/Algeria
218: INDIAN	: India & Nepal		
219: INDIAN 1954	: Thailand		
220: INDIAN 1960	: Vietnam (near 16N)		

APPENDIX 3 DIGITAL INTERFACE

Input Sentences

NMEA1/NMEA2 ports:

ALR, BMC, BMR, DBT, DPT, GGA, GLL, GNS, GSA, GSV, HDG, HDM, HDT, MTW, MWV, RMB, RMC, THS, TTM, VDM, VHW, VTG, VWR, VWT, XTE, ZDA

NMEA3(HDG) port:

HDG, HDM, HDT, THS, VHW

Output Sentences

NMEA1/NMEA2 ports:

ACK, RSD, TLL, TTM

NMEA3(HDG) port:

No output sentence.

FURUNO Proprietary Sentences

Input: PFEC (GPast, GPstd, GPtst, GPwav, DRtnm, DRtsm, idfnc, pireq)

Output: PFEC (GPclr, GPint, GPpsp, GPset, GPtrq, GPwas, idatr, idfnc, pidat)

Data Sentences

Input: PFEC (GPast, GPstd, GPtst, GPwav, DRtnm, DRtsm, idfnc, pireq)

Output: PFEC (GPclr, GPint, GPpsp, GPset, GPtrq, GPwas, idatr, idfnc, pidat)

Sentence Description

ALR-Set Alarm State

\$**ALR,Hhmmss.ss,xxx,A,A,c—c,*hh<CR><LF>

1 2 3 4 5

1. Time of alarm condition change, UTC (000000.00 to 240001.00)
2. Unique alarm number (identifier) at alarm source (000 to 999)
3. Alarm condition (A=threshold exceeded, V=not exceeded)
4. Alarm acknowledge state (A=acknowledged, V=not acknowledged)
5. Alarm description text (alphanumeric)

BMC-Bearing and Distance to Waypoint-Great Circle

\$ GPBWC,hhmmss.ss,IIII.II, a,IIII.II,a,yyy.y,T, yyy.y,M,yyy.y,N,c--c,A,*hh<CR><LF>

1 2 3 4 5 6 7 8 9 10 11 12 13

1. UTC of observation (000000.00 to 240001.00)
2. Waypoint latitude (0.00000 to 9000.00000)
3. N/S
4. Waypoint longitude (0.00000 to 18000.00000)
5. E/W
6. Bearing, degrees true (0.00 to 360.00)
7. Unit, True
8. Bearing, degrees (0.00 to 360.00)
9. Unit, Magnetic
10. Distance, nautical miles (0.000 to 10000)
11. Unit, N
12. Waypoint ID (Max. 13 characters)
13. Mode Indicator (A=Autonomous D=Differential S=Simulator)

APPENDIX 3 DIGITAL INTERFACE

BWR-Bearing Waypoint to Waypoint

\$ GPBWR,hhmmss.ss,IIII.II,a,IIII.II,a,yyy.y,T,yyy.y,M,yyy.y,N,c--c,A,*hh<CR><LF>
1 2 3 4 5 6 7 8 9 10 11 12 13

1. UTC of observation (000000.00 to 240001.00)
2. Waypoint latitude (0.00000 to 9000.00000)
3. N/S
4. Waypoint longitude (0.00000 to 18000.00000)
5. E/W
6. Bearing, degrees true (0.00 to 360.00)
7. Unit, True
8. Bearing, degrees (0.00 to 360.00)
9. Unit, Magnetic
10. Distance, nautical miles (0.000 to 10000)
11. Unit, N
12. Waypoint ID (Max. 13 characters)
13. Mode Indicator (A=Autonomous D=Differential S=Simulator)

DBT-Depth Below Transducer

\$**DBT,xxxx.x,f,xxxx.x,M,xxxx.x,F,*hh<CR><LF>
1 2 3 4 5 6

1. Water depth (0.00 to 99999.99)
2. feet
3. Water depth (0.00 to 99999.99)
4. Meters
5. Water depth (0.00 to 99999.99)
6. Fathoms

DPT-Depth

\$**DPT,x.x,x.x,x.x,*hh<CR><LF>
1 2 3

1. Water depth relative to the transducer, meters (0.00 to 99999.99)
2. Offset from transducer, meters (-99.99 to 99.99)
3. Minimum range scale in use (no use)

GGA-Global Positioning System (GPS) Fix Data

\$**GGA,hhmmss.ss,IIII.II,a,yyyyy.yyy,a,x,xx,x.x,x.x,M,x.x,M,x.x,xxxx,*hh<CR><LF>
1 2 3 4 5 6 7 8 9 10 11 12 13 14

1. UTC of position (no use)
2. Latitude (0.00000 to 9000.00000)
3. N/S
4. Longitude (0.00000 to 18000.00000)
5. E/W
6. GPS quality indicator (1 to 5, 8)
7. Number of satellite in use (00 to 99)
8. Horizontal dilution of precision (0.00 to 999.99)
9. Antenna altitude above/below mean sea level (-999.99 to 9999.99)
10. Unit, m
11. Geoidal separation (-999.99 to 9999.99)
12. Unit, m
13. Age of differential GPS data (0 to 99)
14. Differential reference station ID (0000 to 1023)

GLL-Geographic Position - Latitude/Longitude

```
$**GLL,lll.lll,a,yyyyy.yyy,a,hmmss.ss,a,x,*hh<CR><LF>
```

1. Latitude (0.00000 to 9000.00000)
2. N/S
3. Longitude (0.00000 to 18000.00000)
4. E/W
5. UTC of position (no use)
6. Status (A=data valid V=data invalid)
7. Mode indicator (A=Autonomous D=Differential S=Simulator)

GNS-GNSS Fix Data

```
$**GNS,hmmss.ss,lll.lll,a,llll.lll,a,c--c,xx,x.x,x.x,x.x,x.x,x.x,x.x,a*hh<CR><LF>
```

1. UTC of position (no use)
2. Latitude (0.00000 to 9000.00000)
3. N/S
4. Longitude (0.00000 to 18000.00000)
5. E/W
6. Mode indicator
N=No fix A=Autonomous D=Differential P=Precise R=Real Time Kinematic
F=Float RTK E=Estimated Mode M=Manual Input Mode S=Simulator Mode
7. Total number of satellites in use (00 to 99)
8. HDOP (0.0 to 999.99)
9. Antenna altitude, meters (-999.99 to 9999.99)
10. Geoidal separation (-999.99 to 9999.99)
11. Age of differential data (0 to 999)
12. Differential reference station ID (0000 to 1023)
13. Navigational status indicator

GSA-GNSS DOP and Active Satellites

```
$--GSA,a,x,xx,xx,xx,xx,xx,xx,xx,xx,xx,xx,xx,x.x,x.x,x.x,*hh<CR><LF>
```

1. Mode (M=manual, forced to operate in 2=2D 3=3D mode
A=automatic, allowed to automatically switch 2D/3D)
2. Mode (1=fix not available 2=2D 3=3D)
3. ID number of satellites used in solution (01 to 96, null)
4. PDOP (0.00 to 999.99)
5. HDOP (0.00 to 999.99)
6. VDOP (0.00 to 999.99)

GSV-GNSS Satellites in View

```
$**GSV,x,x,xx,xx,xx,xxx,xx,.....,xx,xx,xxx,xx,*hh<CR><LF>
```

1. Total number of messages (1 to 9)
2. Message number (1 to 9)
3. Total number of satellites in view (01 to 99)
4. Satellite ID number (01 to 96)
5. Elevation, degrees (00 to 90)
6. Azimuth, degrees true (000 to 359)
7. SNR(C/No) (00 to 99(dB-Hz), null when not tracking)
8. Second and third SVs
9. Fourth SV

APPENDIX 3 DIGITAL INTERFACE

HDG-Heading, Deviation and Variation

\$**HDG,x.x,x.x,a,x.x,a*hh<CR><LF>
1 2 3 4 5

1. Magnetic sensor heading, degrees (0.00 to 360.00)
2. Magnetic deviation, degrees (0.0 to 180.00)
3. E/W
4. Magnetic variation, degrees (0.0 to 180.00)
5. E/W

HDM-Heading, Magnetic

\$**HDM,x.x,M*hh<CR><LF>
1 2

1. Heading, degrees (0.00 to 360.00)
2. Magnetic (M)

HDT-Heading, True

\$**HDT,xxx.x,T*hh<CR><LF>
1 2

1. Heading, degrees (0.00 to 360.00)
2. True (T)

MWV-Wind Speed and Angle

\$**MWV,x.x,a,x.x,a,A*hh<CR><LF>
1 2 3 4 5

1. Wind angle, degrees (0 to 350)
2. Reference (R/T)
3. Wind speed (0.00 to 9999.99)
4. Wind speed units (K=km/h M=m/s N=nm)
5. Status (A=Valid V=Not valid)

MTW-Water Temperature

\$**MTW,x.x,C<CR><LF>
1

1. Water temperature, degrees C (-9.999 to 99.999)

RMB-Recommended Minimum Specific Navigation Information

```
$GPRMB,A,x.x,L,CCCC,CCCC,xxxx.xx,a,xxxxxx.xx,a,xxx.x,xxx,xx.x,A,a*hh <CR><LF>
      1 2 3 4      5      6 7      8 9 10 11 12 13 14
```

1. Data status (A=Data valid, V=Navigation receiver warning)
2. Cross track error (NM) (0.00 to 9.99)
3. Direction to steer (L/R)
4. Origin waypoint ID
5. Destination waypoint ID
6. Destination waypoint latitude (0.0000 to 9000.000)
7. N/S
8. Destination waypoint longitude (0.0000 to 18000.000)
9. E/W
10. Range to destination, nautical miles (0.000 to 10000)
11. Bearing to destination, degrees true (0.0 to 359.9)
12. Destination closing velocity, knots (-99.9 to 99.9)
13. Arrival status (A=Arrival circle entered or perpendicular passed, V=Not entered/passed)
14. Mode indicator (A= Autonomous D= Differential mode E=Estimated (dead reckoning mode) M=Manual input mode S= Simulator N=Data not valid)

RMC-Recommended Minimum Specific GNSS Data

```
**RMC,hhmmss.ss,A,lll.ll,a,yyyy.yy,a,x.x,x.x,ddmmyy,x.x,a,a*hh<CR><LF>
      1 2 3 4      5      6 7 8      9      10 11 12 13
```

1. UTC of position fix (000000 - 235959)
2. Status (A=data valid, V=navigation receiver warning)
3. Latitude (0000.00000 - 9000.0000)
4. N/S
5. Longitude (0000.00000 - 18000.0000)
6. E/W
7. Speed over ground, knots (0.00 - 99.94)
8. Course over ground, degrees true (0.0 - 360.0)
9. Date (010100 - 311299)
10. Magnetic variation, degrees E/W (0.00 - 180.0/NULL)
11. E/W
12. Mode indicator (A= Autonomous mode D= Differential mode S= Simulator
F=Float RTK P=Precise R=Real time kinematic E=Estimated (DR) M=Manual)
13. Navigational status indication (S=Safe C=Caution U=Unsafe V=Navigational status not valid)

THS-True Heading and Status

```
**THS,xxx.x,a*hh<CR><LF>
      1 2
```

1. Heading, degrees True (0.00 to 360.00)
2. Mode indicator (A=Autonomous E=Estimated M=Manual input
S=Simulator V=Data not valid)

APPENDIX 3 DIGITAL INTERFACE

TTM-Tracked Target Message

\$**TTM,05,12.34,23.4,R,45.67,123.4,T,1.23,8.23,N,c--c,T,R,hhmmss.ss,M*hh<CR><LF>
1 2 3 4 5 6 7 8 9 10 11 12 13 14 15

1. Target number (00 to 999)
2. Target distance from own ship (0.000 - 99.999)
3. Bearing from own ship,degrees (0.0 - 359.9)
4. True or Relative (T)
5. Target speed (0.00 - 999.99, null)
6. Target course, degrees (0.0 - 359.9, null)
7. True or Relative
8. Distance of closet point of approach (0.00 - 99.99, null)
9. Time to CPA, min., "-" increasing (-99.99 - 99.99, null)
10. Speed/distance units (N=nm)
11. Target name (null)
12. Target status (L=Lost Q=Acquiring T=Tracking)
13. Reference target (R, NULL otherwise)
14. UTC of data (null)
15. Type of acquisition (A=Automatic M=Manual)

VDM-AIS VHF Data-Link Message

!**VDM,x,x,x,x,s--s,x,*hh<CR><LF>
1 2 3 4 5 6

1. Total number of sentences needed to transfer the message (1 to 9)
2. Message sentence number (1 to 9)
3. Sequential message identifier (0 to 9, NULL)
4. AIS channel Number (A or B)
5. Encapsulated ITU-R M.1371 radio message (1 - 63 bytes)
6. Number of fill-bits (0 to 5)

VHW-Water Speed and Heading

\$GPVHW,x.x,T,x.x,M,x.x,N,x.x,K,*hh <CR><LF>
1 2 3 4 5 6 7 8

1. Heading, degrees (0.0 to 359.9, null)
2. T=True (fixed)
3. Heading, degrees (0.0 to 359.9, null)
4. M=Magnetic (fixed)
5. Speed, knots (0.0 to 9999.9)
6. N=Knots (fixed)
7. Speed, knots (0.0 to 9999.9)
8. K=km/hr (fixed)

VTG-Course Over Ground and Ground Speed

\$GPVTG,x.x,T,x.x,M,x.x,N,x.x,K,a,*hh <CR><LF>
1 2 3 4 5 6 7 8 9

1. Course over ground, degrees (0.0 to 359.9)
2. T=True (fixed)
3. Course over ground, degrees (0.0 to 359.9)
4. M=Magnetic (fixed)
5. Speed over ground, knots (0.00 to 9999.9)
6. N=Knots (fixed)
7. Speed over ground (0.00 to 9999.9)
8. K=km/h (fixed)
9. Mode indicator (A=Autonomous, D=Differential E=Estimated (dead reckoning)
M=Manual input S=Simulator N=Data not valid)

VWR-Wind Relative Bearing and Velocity

\$**VWR,x.x,x,x.x,N,x.x,M,x.x,K<CR><LF>
 1 2 3 4 5 6 7 8

1. Measured wind angle relative to the vessel, degrees (0.0 to 180.0)
2. L=Left semicircle, R=Right semicircle
3. Velocity, knots (0.0 to 9999.9)
4. Unit (N, fixed)
5. Velocity (0.0 to 999.9)
6. Unit (M, fixed)
7. Velocity, km/h
8. Unit (K, fixed)

VWT-True Wind Speed and Angle

\$**VWT,x.x,x,x.x,N,x.x,M,x.x,K<CR><LF>
 1 2 3 4 5 6 7 8

1. Measured wind angle relative to the vessel, degrees (0.0 to 180.0)
2. L=Left semicircle, R=Right semicircle
3. Velocity, knots (0.0 to 9999.9)
4. Unit (N, fixed)
5. Velocity (0.0 to 999.9)
6. Unit (M, fixed)
7. Velocity, km/h
8. Unit (K, fixed)

XTE-Cross-Track Error, Measured

\$**XTE,A,A,x.x,a,N,a,*hh<CR><LF>
 1 2 3 4 5 6

1. Status: A=data valid V=LORAN C blink or SNR warning
2. Status: V=LORAN C blink or SNR warning
3. Magnitude of cross-track error (0.0000 - 9.9999)
4. Direction to steer, L/R
5. Units, nautical miles (fixed)
6. Mode indicator (A=Autonomous mode D=Differential mode S=Simulator mode)

ZDA-Time and Date

\$GPZDA,hhmmss.ss,xx,xx,xxxx,xx,xx<CR><LF>
 1 2 3 4 5 6

1. UTC (000000 to 235959)
2. Day (01 to 31)
3. Month (01 to 12)
4. Year (UTC, 0000 to 9999)
5. Local zone, hours (-13 to ±13)
6. Local zone, minutes (00 to ±59)

APPENDIX 4 JIS CABLE GUIDE

Cables listed in the manual are usually shown as Japanese Industrial Standard (JIS). Use the following guide to locate an equivalent cable locally.

JIS cable names may have up to 6 alphabetical characters, followed by a dash and a numerical value (example: DPYC-2.5).

For core types D and T, the numerical designation indicates the *cross-sectional Area (mm²)* of the core wire(s) in the cable.

For core types M and TT, the numerical designation indicates the *number of core wires* in the cable.

1. Core Type

- D: Double core power line
- T: Triple core power line
- M: Multi core
- TT: Twisted pair communications (1Q=quad cable)

2. Insulation Type

- P: Ethylene Propylene Rubber

3. Sheath Type

- Y: PVC (Vinyl)

4. Armor Type

- C: Steel

5. Sheath Type

- Y: Anticorrosive vinyl sheath

6. Shielding Type

- S: All cores in one sheath
- S: Individually sheathed cores
- SLA: All cores in one shield, plastic tape w/aluminum tape
- SLA: Individually shielded cores, plastic tape w/aluminum tape



DPYCY



TPYCY

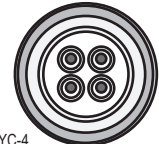

MPYC-4

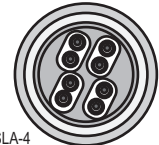

TTYCSLA-4

EX: ^{1 2 3 4 5 6} TTYCYSLA - 4
 Designation type | # of twisted pairs

EX: ^{1 2 3 4} MPYC - 4
 Designation type | # of cores

The following reference table lists gives the measurements of JIS cables commonly used with Furuno products:

Type	Area	Core Diameter	Cable Diameter	Type	Area	Core Diameter	Cable Diameter
DPYC-1.5	1.5mm ²	1.56mm	11.7mm	TTYCS-1	0.75mm ²	1.11mm	10.1mm
DPYC-2.5	2.5mm ²	2.01mm	12.8mm	TTYCS-1T	0.75mm ²	1.11mm	10.6mm
DPYC-4	4.0mm ²	2.55mm	13.9mm	TTYCS-1Q	0.75mm ²	1.11mm	11.3mm
DPYC-6	6.0mm ²	3.12mm	15.2mm	TTYCS-4	0.75mm ²	1.11mm	16.3mm
DPYC-10	10.0mm ²	4.05mm	17.1mm	TTYCSLA-1	0.75mm ²	1.11mm	9.4mm
DPYCY-1.5	1.5mm ²	1.56mm	13.7mm	TTYCSLA-1T	0.75mm ²	1.11mm	10.1mm
DPYCY-2.5	2.5mm ²	2.01mm	14.8mm	TTYCSLA-1Q	0.75mm ²	1.11mm	10.8mm
DPYCY-4	4.0mm ²	2.55mm	15.9mm	TTYCSLA-4	0.75mm ²	1.11mm	15.7mm
MPYC-2	1.0mm ²	1.29mm	10.0mm	TTYCY-1	0.75mm ²	1.11mm	11.0mm
MPYC-4	1.0mm ²	1.29mm	11.2mm	TTYCY-1T	0.75mm ²	1.11mm	11.7mm
MPYCSLA-4	1.0mm ²	1.29mm	11.4mm	TTYCY-1Q	0.75mm ²	1.11mm	12.6mm
MPYC-7	1.0mm ²	1.29mm	13.2mm	TTYCY-4	0.75mm ²	1.11mm	17.7mm
MPYC-12	1.0mm ²	1.29mm	16.8mm	TTYCY-4S	0.75mm ²	1.11mm	21.1mm
TPYC-1.5	1.5mm ²	1.56mm	12.5mm	TTYCY-4SLA	0.75mm ²	1.11mm	19.5mm
TPYC-2.5	2.5mm ²	2.01mm	13.5mm	TTYCYS-1	0.75mm ²	1.11mm	12.1mm
TPYC-4	4.0mm ²	2.55mm	14.7mm	TTYCYS-4	0.75mm ²	1.11mm	18.5mm
TPYCY-1.5	1.5mm ²	1.56mm	14.5mm	TTYCYSLA-1	0.75mm ²	1.11mm	11.2mm
TPYCY-2.5	2.5mm ²	2.01mm	15.5mm	TTYCYSLA-4	0.75mm ²	1.11mm	17.9mm
TPYCY-4	4.0mm ²	2.55mm	16.9mm				

APPENDIX 5 RADIO REGULATORY INFORMATION

USA-Federal Communications Commission (FCC)

This device complies with part 15 of the FCC Rules. Operation is subject to the following two conditions: (1) This device may not cause harmful interference, and (2) this device must accept any interference received, including interference that may cause undesired operation.

Any changes or modifications not expressly approved by the party responsible for compliance could void the user's authority to operate the equipment.

Caution: Exposure to Radio Frequency Radiation.

This equipment complies with FCC radiation exposure limits set forth for an uncontrolled environment and meets the FCC radio frequency (RF) Exposure Guidelines in Supplement C to OET65.

This equipment should be installed and operated keeping the radiator at least 85cm or more away from person's body.

This device must not be co-located or operating in conjunction with any other antenna or transmitter.

Canada-Industry Canada (IC)

This device complies with RSS 210 of Industry Canada.

Operation is subject to the following two conditions:

- (1) This device may not cause interference, and
- (2) This device must accept any interference, including interference that may cause undesired operation of this device.

L'utilisation de ce dispositif est autorisée seulement aux conditions suivantes:

- (1) il ne doit pas produire de brouillage et
- (2) l'utilisateur du dispositif doit être prêt à accepter tout brouillage radioélectrique reçu, même si ce brouillage est susceptible de compromettre le fonctionnement du dispositif.

Caution: Exposure to Radio Frequency Radiation.

This equipment complies with IC radiation exposure limits set forth for an uncontrolled environment and meets RSS-102 of the IC radio frequency (RF) Exposure rules. This equipment should be installed and operated keeping the radiator at least 85cm or more away from person's body.

Cet équipement est conforme aux limites d'exposition aux rayonnements énoncées pour un environnement non contrôlé et respecte les règles d'exposition aux fréquences radioélectriques (RF) CNR-102 de l'IC. Cet équipement doit être installé et utilisé en gardant une distance de 85 cm ou plus entre le dispositif rayonnant et le corps.

To reduce potential radio interference to other users, the antenna type and its gain should be so chosen that the equivalent isotropically radiated power (EIRP) is not more than that required for successful communication.

APPENDIX 6 ALERT LIST

This radar outputs alert information in ALR format. When the alert status changes from OFF (no alert) to ON (error), an alert pop-up appears and the audio alarm sounds.

- The alert pop-up can be erased and the audio alarm silenced by pressing any key.
- The alert pop-up and the audio alarm are generated whenever an alarm condition occurs or re-occurs. This condition continues until all the causes for an alert are removed or the alert(s) are acknowledged.
- When multiple alerts are generated simultaneously, and there is no alert acknowledgement, the audio alarm continues to sound no matter even if an alert condition has gone. Also, the pop-up remains displayed and the latest alert appears in the pop-up
- When there is no alert acknowledgment, the audio alarm continues until the condition causing the alert(s) is removed. The pop-up remains displayed.
- When multiple alerts are generated simultaneously, press any key to acknowledge all alerts.
- To indicate that multiple alerts have been generated simultaneously, the pop-up shows “(!)” after the alert name, as in the example below.

[SIGNAL MISSING] POSITION (!)

SIGNAL MISSING ALERTS

This radar releases an audiovisual alarm against missing signals.

- [SIGNAL MISSING] TRIGGER
The trigger signal from the antenna unit is missing.

[SIGNAL MISSING] TRIGGER

- [SIGNAL MISSING] HEADING
The heading signal from the antenna unit is missing.

[SIGNAL MISSING] HEADING

- [SIGNAL MISSING] BEARING
The bearing signal from the antenna unit is missing.

[SIGNAL MISSING] BEARING

- [SIGNAL MISSING] VIDEO
The video signal from the antenna unit is missing.

[SIGNAL MISSING] VIDEO

- [SIGNAL MISSING] POSITION
NMEA position data is missing.

[SIGNAL MISSING] POSITION

APPENDIX 6 ALERT LIST

- [SIGNAL MISSING] NMEA HDG
NMEA heading signal is missing.

[SIGNAL MISSING] NMEA HDG

- [SIGNAL MISSING] ANT ERR
No communication with antenna unit for one minute.

[SIGNAL MISSING] ANT ERR

TARGET ALARM 1 / TARGET ALARM 2 ALERTS

This radar releases an audiovisual alarm against a target that enters (or exits) the target alarm zone.

- IN
A target is entering the target alarm zone.

[TARGET ALARM 1] IN

- OUT
A target is exiting the target alarm zone.

[TARGET ALARM 1] OUT

TT ALERTS

The audiovisual alarm is given against TT in the following cases.

- COLLISION
A tracked target whose CPA and TCPA are lower than those set for the CPA and TCPA alarm.

[TT ALARM] COLLISION

- LOST
A tracked target has become lost.

[TT ALARM] LOST

- PROXIMITY
A target is within the range set for the proximity alarm.

[TT ALARM] PROXIMITY

AIS ALERTS

This radar releases an audiovisual alarm against AIS targets in the following cases.

- COLLISION

A AIS target whose CPA and TCPA are lower than the those set for the CPA/TCPA alarm.

[AIS ALARM] COLLISION

- PROXIMITY

A target is within the range set for the proximity alarm.

[AIS ALARM] PROXIMITY

- TARGET FULL

The capacity for AIS targets has been reached.

[AIS ALARM] TARGET FULL

AIS SYSTEM ALERTS

This radar releases an audiovisual alarm when it receives an alert (ALR sentence) from the connected AIS transponder. These alerts are as shown in the table below.

ALR No.	Error	Error message
ALR No. 1 Alert	TX error	[AIS SYSTEM] TX
ALR No. 2 Alert	Antenna standing wave abnormality	[AIS SYSTEM] ANT
ALR No. 3 Alert	RX channel 1 (RX1) error	[AIS SYSTEM] CH1
ALR No. 4 Alert	RX channel 2 (RX2) error	[AIS SYSTEM] CH2
ALR No. 5 Alert	RX channel 70 (DSC) error	[AIS SYSTEM] CH70
ALR No. 6 Alert	System failure	[AIS SYSTEM] FAIL
ALR No. 7 Alert	Operating without synchronizing with UTC	[AIS SYSTEM] UTC
ALR No. 8 Alert	Loss of minimum input device (MKD)	[AIS SYSTEM] MKD
ALR No. 9 Alert	Position mismatch between internal GNSS and external GNSS	[AIS SYSTEM] GNSS
ALR No. 10 Alert	Nav status is incorrect	[AIS SYSTEM] NAV_STATUS
ALR No. 11 Alert	Inconsistent with COG and HDG data	[AIS SYSTEM] HDG_OFFSET
ALR No. 14 Alert	Received AIS-SART (emergency info)	[AIS SYSTEM] SART
ALR No. 25 Alert	Loss of EPFS position-fixing device	[AIS SYSTEM] EPFS
ALR No. 26 Alert	Loss of position data	[AIS SYSTEM] L/L
ALR No. 29 Alert	Loss of speed data	[AIS SYSTEM] SOG
ALR No. 30 Alert	Loss of course data	[AIS SYSTEM] COG
ALR No. 32 Alert	Loss of heading data	[AIS SYSTEM] HDG
ALR No. 35 Alert	Loss of ROT data	[AIS SYSTEM] ROT

OTHER

- High Temperature
The audiovisual alarm is given when the temperature in the display unit rises above the temperature limit.

[OTHER] OVER_HEAT

**SPECIFICATIONS OF MARINE RADAR
MODEL1815**

1 ANTENNA UNIT

- 1.1 Antenna type Patch array
- 1.2 Radiator length 18-inch
- 1.3 Horizontal beam width 5.2°
- 1.4 Vertical beam width 25°
- 1.5 Sidelobe -20 dB or less (within ±20° of main-lobe)
-25 dB or less (outside ±20° of main-lobe)
- 1.6 Rotation 24 rpm

2 TRANSCEIVER MODULE (CONTAINED IN ANTENNA UNIT)

- 2.1 Tx frequency 9410±30 MHz
- 2.2 Radiation type P0N
- 2.3 Output power 4 kW
- 2.4 Duplexer Ferrite circulator
- 2.5 Intermediate frequency 60 MHz
- 2.6 Range scale, Pulse length (PL) and Pulse repetition rate (PRR)

Range (NM)	PL (μs)	PRR (Hz approx.)
0.0625 to 0.5	0.08	360
0.75 to 2	0.3	360
3 to 36	0.8	360

- 2.7 Minimum range 25 m
- 2.8 Range resolution 25 m
- 2.9 Range accuracy 1 % of range in use or 0.01 NM, whichever is greater
- 2.10 Bearing resolution 5.2°
- 2.11 Bearing accuracy ±1°

3 DISPLAY UNIT

- 3.1 Screen type 8.4-inch color LCD, 640 (V) x 480 (H) dots, VGA
- 3.2 Effective radar diameter 128 mm
- 3.3 Brightness 0.27 to 600 cd/m² typical (16 steps)
- 3.4 Range scales and Ring interval

Range scale (NM)	0.0625	0.125	0.25	0.5	0.75	1	1.5	2	3	4	6	8	12	16	24	36
Ring interval (NM)	0.03125	0.0625	0.125	0.125	0.25	0.25	0.5	0.5	1	1	2	2	3	4	6	12
Number of rings	2	2	2	4	3	4	3	4	3	4	3	4	4	4	4	3

- 3.5 Marks Heading line, Bearing scale, Range ring, Tuning indicator, Cursor, North mark, Variable range marker (VRM), Electric bearing line (EBL), Target alarm zone, Zoom window, Waypoint mark*, Origin mark*
- 3.6 Alphanumeric indication Range, Range ring interval, Display mode (H UP/ C UP/ N UP/ TM/ TRUE VIEW), Off-center (OFFCENT (M/A/C)), Heading data*, Target trails, Tuning indicator, Target alarms, Echo stretch (ES),

Echo average (EAV), Electric bearing line (EBL), Vector time*, Range and bearing to cursor or cursor position*, Interference rejecter (IR), Auto anti-clutter (A/C Auto), Variable range marker (VRM), Navigation data*(position, speed, course), TT/AIS/ships target data*

*: external data required

4 INTERFACE

4.1	Number of ports	
	NMEA	3 ports (IEC61162-2, I/O: 2, I: 1)
	Contact closure	1 port (output for external buzzer, 0.3 A max.)
4.2	Data sentences	
	Input	ALR, BWC, BWR, DBT, DPT, DTM, GGA, GLL, GNS, GSA, GSV, HDG, HDT, HDM, MTW, MWV, RMB, RMC, THS, TTM, VDM, VHW, VTG, VWR, VWT, XTE, ZDA
	Output	ACK, RSD, TLL, TTM

5 POWER SUPPLY

5.1	Antenna unit	12-24 VDC (10.8-31.2 V): 2.0-1.0 A (stand-by: 0.8-0.4 A)
5.2	Display unit	12-24 VDC (10.8-31.2 V): 1.2-0.6 A (antenna unit not connected)

6 ENVIRONMENTAL CONDITIONS

6.1	Ambient temperature	
	Antenna unit	-25°C to +55°C (storage: -30°C to +70°C)
	Display unit	-15°C to +55°C (storage: -30°C to +70°C)
6.2	Relative humidity	95% or less at +40°C
6.3	Degree of protection	
	Antenna unit	IP26
	Display unit	IP56
6.4	Vibration	IEC 60945 Ed.4

7 UNIT COLOR

7.1	Antenna unit	N9.5 (cover), PANTONE2945C (bottom)
7.2	Display unit	N2.5

PACKING LIST
MODEL1815-**-0

03HU-X-9860 -0 1/1
A-1

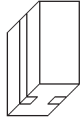
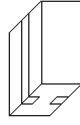
N A M E	O U T L I N E	D E S C R I P T I O N / C O D E N o.	Q ' T Y
ユニット			
空中線部箱詰 ANTENNA UNIT COMPLETE SET		RSB-127-120 000-034-791-00	1
指示部箱詰 DISPLAY UNIT COMPLETE SET		RDP-157-** 000-034-793-00 **	1



コート番号末尾の[**]は、選用品の代表コードを表します。
CODE NUMBER ENDING WITH "**" INDICATES THE CODE NUMBER OF REPRESENTATIVE MATERIAL

(略図の寸法は、参考値です。 DIMENSIONS IN DRAWING FOR REFERENCE ONLY.)

C3666-Z10-A

PACKING LIST
MODEL1815-E-5-MIK

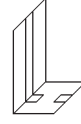
03HU-X-9864 -1 1/1
A-2



N A M E	O U T L I N E	D E S C R I P T I O N / C O D E N o.	Q ' T Y
ユニット			
空中線部箱詰 ANTENNA UNIT COMPLETE SET		RSB-127-120-MIJ 000-034-958-00	1
指示部箱詰 DISPLAY UNIT COMPLETE SET		RDP-157-E-MIK 000-034-956-00	1
工事材料			
ケーブル(クシビ)		FRU-CF-FF-05M 000-194-354-10	1

(略図の寸法は、参考値です。 DIMENSIONS IN DRAWING FOR REFERENCE ONLY.)

C3666-Z14-B

PACKING LIST
MODEL1815-**-5

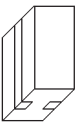
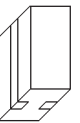
03HU-X-9865 -0 1/1
A-3

NAME	OUTLINE	DESCRIPTION/CODE No.	Q'TY
ユニット			
空中線部箱詰		RSB-127-120	1
ANTENNA UNIT COMPLETE SET		000-034-791-00	
指示部箱詰		RDP-157-*	1
DISPLAY UNIT COMPLETE SET		000-034-793-00 **	
工事材料			
ケーブル(クミビ)		FRU-OF-FF-05M	1
CABLE ASSEMBLY		000-194-354-10	



コード番号末尾の[**]は、選用品の代表コードを表します。
CODE NUMBER ENDING WITH "**" INDICATES THE CODE NUMBER OF REPRESENTATIVE MATERIAL

(略図の寸法は、参考値です。DIMENSIONS IN DRAWING FOR REFERENCE ONLY.)

C3666-Z15-A

PACKING LIST
MODEL1815-**-10

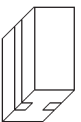
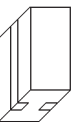
03HU-X-9861 -0 1/1
A-4

NAME	OUTLINE	DESCRIPTION/CODE No.	Q'TY
ユニット			
空中線部箱詰		RSB-127-120	1
ANTENNA UNIT COMPLETE SET		000-034-791-00	
指示部箱詰		RDP-157-*	1
DISPLAY UNIT COMPLETE SET		000-034-793-00 **	
工事材料			
ケーブル(クミビ)		FRU-OF-FF-10M	1
CABLE ASSEMBLY		000-192-825-10	

コード番号末尾の[**]は、選用品の代表コードを表します。
CODE NUMBER ENDING WITH "**" INDICATES THE CODE NUMBER OF REPRESENTATIVE MATERIAL



(略図の寸法は、参考値です。DIMENSIONS IN DRAWING FOR REFERENCE ONLY.)

C3666-Z11-A

PACKING LIST

MODEL1815-**-15

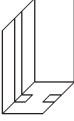
03HU-X-9862 -0 1/1
A-5

NAME	OUTLINE	DESCRIPTION/CODE No.	Q'TY
ユニット			
空中線部箱詰		RSB-127-120	1
ANTENNA UNIT COMPLETE SET		000-034-791-00	
指示部箱詰		RDP-157-*	1
DISPLAY UNIT COMPLETE SET		000-034-793-00 **	
工事材料			
ケーブル(クミビ)		FRU-OF-FF-15M	1
CABLE ASSEMBLY		000-192-826-10	

コード番号末尾の[**]は、選用品の代表コードを表します。
CODE NUMBER ENDING WITH "**" INDICATES THE CODE NUMBER OF REPRESENTATIVE MATERIAL



(略図の寸法は、参考値です。 DIMENSIONS IN DRAWING FOR REFERENCE ONLY.)

C3666-Z12-A

PACKING LIST

MODEL1815-**-20

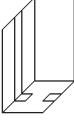
03HU-X-9863 -0 1/1
A-6

NAME	OUTLINE	DESCRIPTION/CODE No.	Q'TY
ユニット			
空中線部箱詰		RSB-127-120	1
ANTENNA UNIT COMPLETE SET		000-034-791-00	
指示部箱詰		RDP-157-*	1
DISPLAY UNIT COMPLETE SET		000-034-793-00 **	
工事材料			
ケーブル(クミビ)		FRU-OF-FF-20M	1
CABLE ASSEMBLY		000-192-827-10	

コード番号末尾の[**]は、選用品の代表コードを表します。
CODE NUMBER ENDING WITH "**" INDICATES THE CODE NUMBER OF REPRESENTATIVE MATERIAL

(略図の寸法は、参考値です。 DIMENSIONS IN DRAWING FOR REFERENCE ONLY.)

C3666-Z13-A

PACKING LIST
RSB-127-120

03HU-X-9858 -0 1/1

A-8

NAME	UNIT	OUTLINE	DESCRIPTION/CODE No.	QTY
ユニット 空中線部	UNIT			
ANTENNA UNIT			RSB-127-120 000-034-792-00	1
工事材料	INSTALLATION MATERIALS			
工事材料			CP03-35701 001-314-480-00	1
図書	DOCUMENT			
型紙			E32-01314-* 000-178-948-1*	1
TEMPLATE				

(略図の寸法は、参考値です。DIMENSIONS IN DRAWING FOR REFERENCE ONLY.)

ON

C3666-Z08-A

PACKING LIST
RDP-157

A-7

03HU-X-9859 -1 1/1

NAME	UNIT	OUTLINE	DESCRIPTION/CODE No.	QTY
ユニット 指示部	UNIT			
DISPLAY UNIT			RDP-157-* 000-034-796-00 **	1
予備品	SPARE PARTS			
予備品			SP03-19301 001-534-920-00	1
SPARE PARTS				
付属品	ACCESSORIES			
付属品			FP03-12501 001-492-680-00	1
ACCESSORIES				
工事材料	INSTALLATION MATERIALS			
工事材料			CP03-37501 001-492-650-00	1
INSTALLATION MATERIALS				
図書	DOCUMENT			
取扱説明書			OM*-36660-* 000-192-853-1* **	1
OPERATOR'S MANUAL				
操作要領書(多言語)			MLG-36660-* 000-192-856-1*	1 (*1)
OPERATOR'S GUIDE (MLG)				
操作要領書(中)			NZS-36660-* 000-192-857-1*	1 (*1)
OPERATOR'S GUIDE (NZS)				
操作要領書(和)			OSJ-36660-* 000-192-855-1*	1 (*1)
OPERATOR'S GUIDE (JP)				

1.コード番号末尾の[*]**は、選択品の代表コードを載します。
CODE NUMBER ENDING WITH "*"** INDICATES THE CODE NUMBER OF REPRESENTATIVE MATERIAL.
2.(*1)は、それぞれ仕様選択品を表します。
(*1)INDICATE SPECIFICATION SELECTIVE ITEM.

(略図の寸法は、参考値です。DIMENSIONS IN DRAWING FOR REFERENCE ONLY.)



KR

C3666-Z09-B

A-10

FURUNO

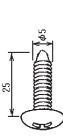
CODE NO.	001-492-650-00	03HU-X-9403 -1
TYPE	CP03-37501	1/1

工事材料表	略図	型名/規格	数量	用途/備考
INSTALLATION MATERIALS	OUTLINE	DESCRIPTIONS	QTY	REMARKS
番号 NO.	名称 NAME			
1	+1777777777 1/2 SELF-TAPPING SCREW	 5X25 SUS304 CODE NO. 000-162-610-10	4	
2	ケーブル組立 CABLE ASSEMBLY	 FRU-OF-F01 CODE NO. 000-192-828-11	1	

A-9

FURUNO

SHIP NO.	SPARE PARTS LIST FOR	U S E	REMARKS/CODE NO.	SETS PER VESSEL
CODE NO.	001-351-470-00	03HP-X-9301 -1	1/1	
TYPE	SP03-17901	BOX NO. P		

ITEM NO.	NAME OF PART	OUTLINE	DWG. NO. OR TYPE NO.	QUANTITY		REMARKS/CODE NO.
				WORKING PER SET	SPARE PER VES	
1	E3-X FUSE		FRU-2P5S-FU-5A-B	1	2	000-168-869-10
MFR'S NAME	FURUNO ELECTRIC CO., LTD.			DWG NO.	C3637-P01-B	1/1

(略図の寸法は、参考値です。 DIMENSIONS IN DRAWING FOR REFERENCE ONLY.)
 型式/コード番号が2原の場合、下原より上原に代わる過渡期品であり、どちらが入っています。 なお、品質は変わりません。
 TWO TYPES AND CODES MAY BE LISTED FOR AN ITEM. THE LOWER PRODUCT MAY BE SHIPPED IN PLACE OF THE UPPER PRODUCT. QUALITY IS THE SAME.

(略図の寸法は、参考値です。 DIMENSIONS IN DRAWING FOR REFERENCE ONLY.)
 FURUNO ELECTRIC CO., LTD.
 KR
 C3666-M03-B

CODE NO.	001-492-680-00	03HU-X-9502-0	1/1
TYPE	FP03-12501		

付属品表

ACCESSORIES

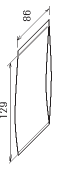
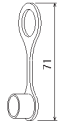
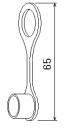
番号 NO.	名称 NAME	略図 OUTLINE	型名/規格 DESCRIPTIONS	数量 QTY	用途/備考 REMARKS
1	液晶クリーニング LCD CLEANING CLOTH		02-195-1082-2 CODE NO. 100-332-692-10	1	
2	コネクタキャップ CONNECTOR CAP		FRU-CAP-CF CODE NO. 000-192-823-10	1	
3	コネクタキャップ CONNECTOR CAP		FRU-CAP-FF CODE NO. 000-192-824-10	1	

(略図の寸法は、参考値です。 DIMENSIONS IN DRAWING FOR REFERENCE ONLY.)

FURUNO ELECTRIC CO., LTD.



KR

C3666-F02-A

CODE NO.	001-351-480-00	03HN-X-9404-0	1/1
TYPE	CP03-35701		

工事材料表

INSTALLATION MATERIALS

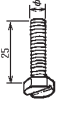
番号 NO.	名称 NAME	略図 OUTLINE	型名/規格 DESCRIPTIONS	数量 QTY	用途/備考 REMARKS
1	平ねり皿金 FLAT WASHER		M10 SUS304 CODE NO. 000-167-232-10	4	
2	バネ皿金 SPRING WASHER		M10 SUS304 CODE NO. 000-167-233-10	4	
3	六角穴付 六角 HEX BOLT (SLOTTED HEAD)		M10X25 SUS304 CODE NO. 000-162-883-10	4	

型式/コード番号が2取の場合、下取より上取に代わる通達部品であり、どちらが入っています。なお、品質は変わりません。
TWO TYPES AND CODES MAY BE LISTED FOR AN ITEM. THE LOWER PRODUCT MAY BE SHIPPED IN PLACE OF THE UPPER PRODUCT.
QUALITY IS THE SAME. DIMENSIONS IN DRAWING FOR REFERENCE ONLY.)

FURUNO ELECTRIC CO., LTD.

C3637-M01-A



表1 TABLE 1

寸法区分 (mm) DIMENSION	公差 (mm) TOLERANCE
L ≤ 50	±1.5
50 < L ≤ 100	±2.5
100 < L ≤ 500	±3

- 注記 1) 指定外の寸法公差は表1による。
 2) # 印寸法は最小サービスマウント間寸法とする。
 3) 取付用ネジはトラスタツピンネジ呼び径5×2.5を使用のこと。
- NOTE 1. TABLE 1 INDICATES TOLERANCE OF DIMENSIONS WHICH IS NOT SPECIFIED.
 2. #: MINIMUM SERVICE CLEARANCE.
 3. USE TAPPING SCREWS Ø5x2.5 FOR FIXING THE UNIT.

DRAWN	2/Sep/2016	I. YAMASAKI	TITLE	RDP-157
CHECKED	2/Sep/2016	H. MAKI	名称	指示部 (卓上装備)
APPROVED	8/Sep/2016	H. MAKI	外寸図	
SCALE	1/4	MODEL1815	NAME	DISPLAY UNIT (TABLETOP MOUNT)
DATE	2.2	REF.No.	03-192-100G-2	OUTLINE DRAWING

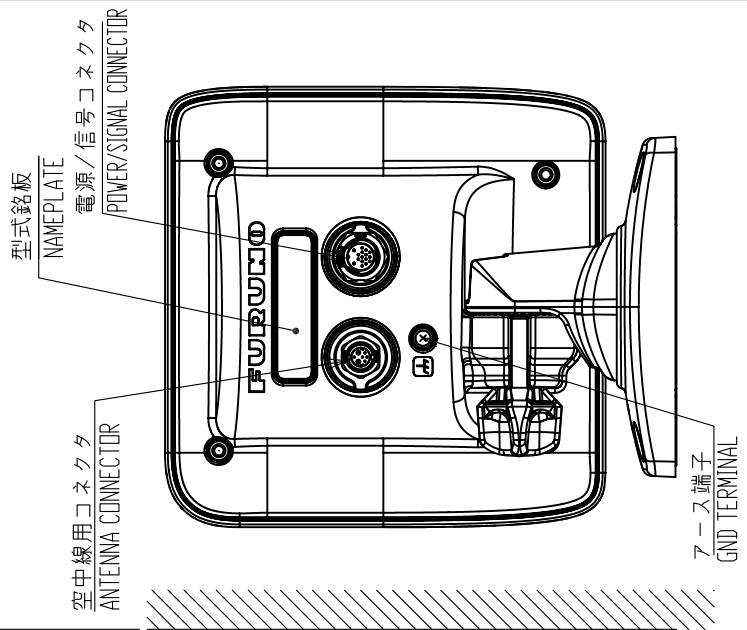
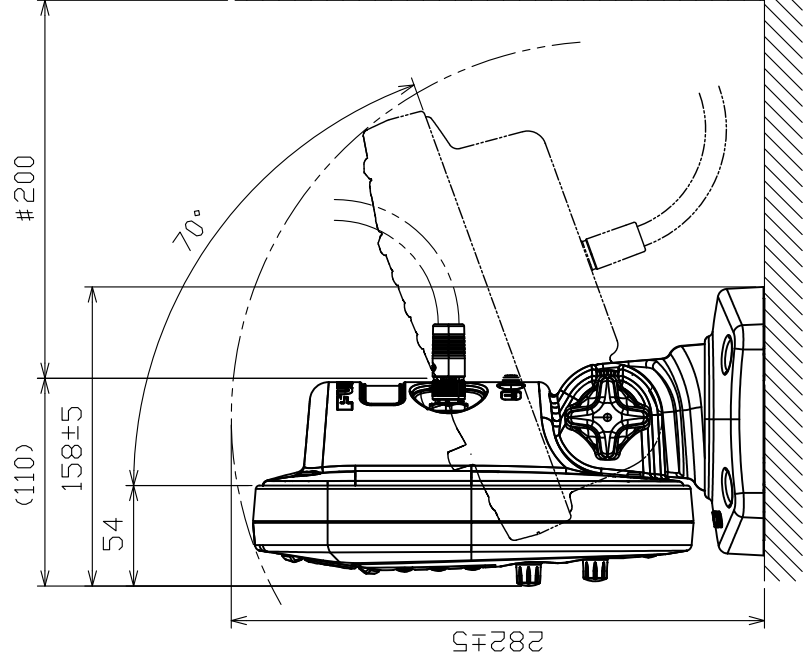
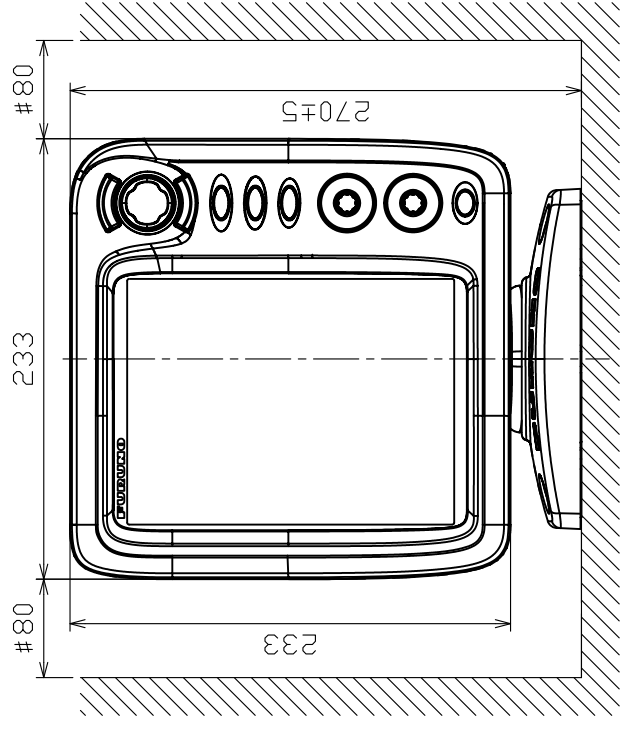
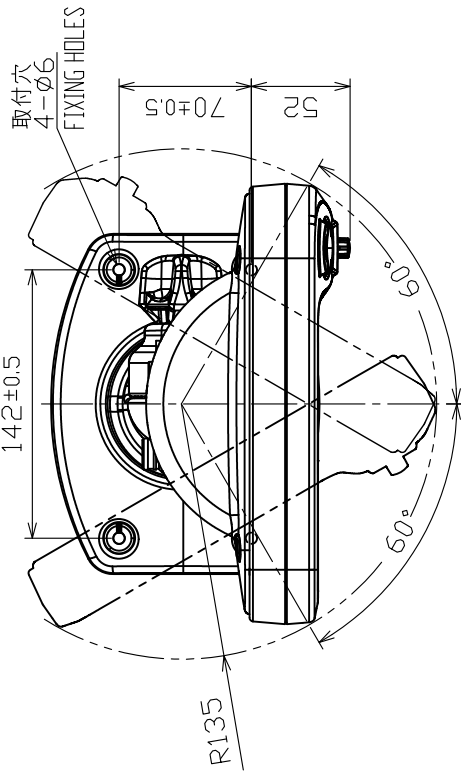

表1 TABLE 1

寸法区分 (mm) DIMENSION	公差 (mm) TOLERANCE
$L \leq 50$	± 1.5
$50 < L \leq 100$	± 2.5
$100 < L \leq 500$	± 3

DRAWN	2/Sep/2016	I.YAMASAKI	TITLE	RDP-157
CHECKED	2/Sep/2016	H.MAKI	名称	指示部 (埋込装備)
APPROVED	8/Sep/2016	H.MAKI	外寸図	
SCALE	1/4	1.7	NAME	DISPLAY UNIT (FLUSH MOUNT)
THICK	C3666-002-A	REF.No.	03-192-110G-2	OUTLINE DRAWING

- 注記 1) 指定外の寸法公差は表1による。
 2) #印寸法は最小サービスマウント用寸法とする。
 3) 取付はM4×50寸切りボルト、M4平座金・バネ座金・蝶ナットを使用のこと。
- NOTE 1. TABLE 1 INDICATES TOLERANCE OF DIMENSIONS WHICH IS NOT SPECIFIED.
 2. # MINIMUM SERVICE CLEARANCE.
 3. USE M4x50 STUD BOLTS AND M4 P.W./S.W./WING NUTS FOR FIXING THE UNIT.

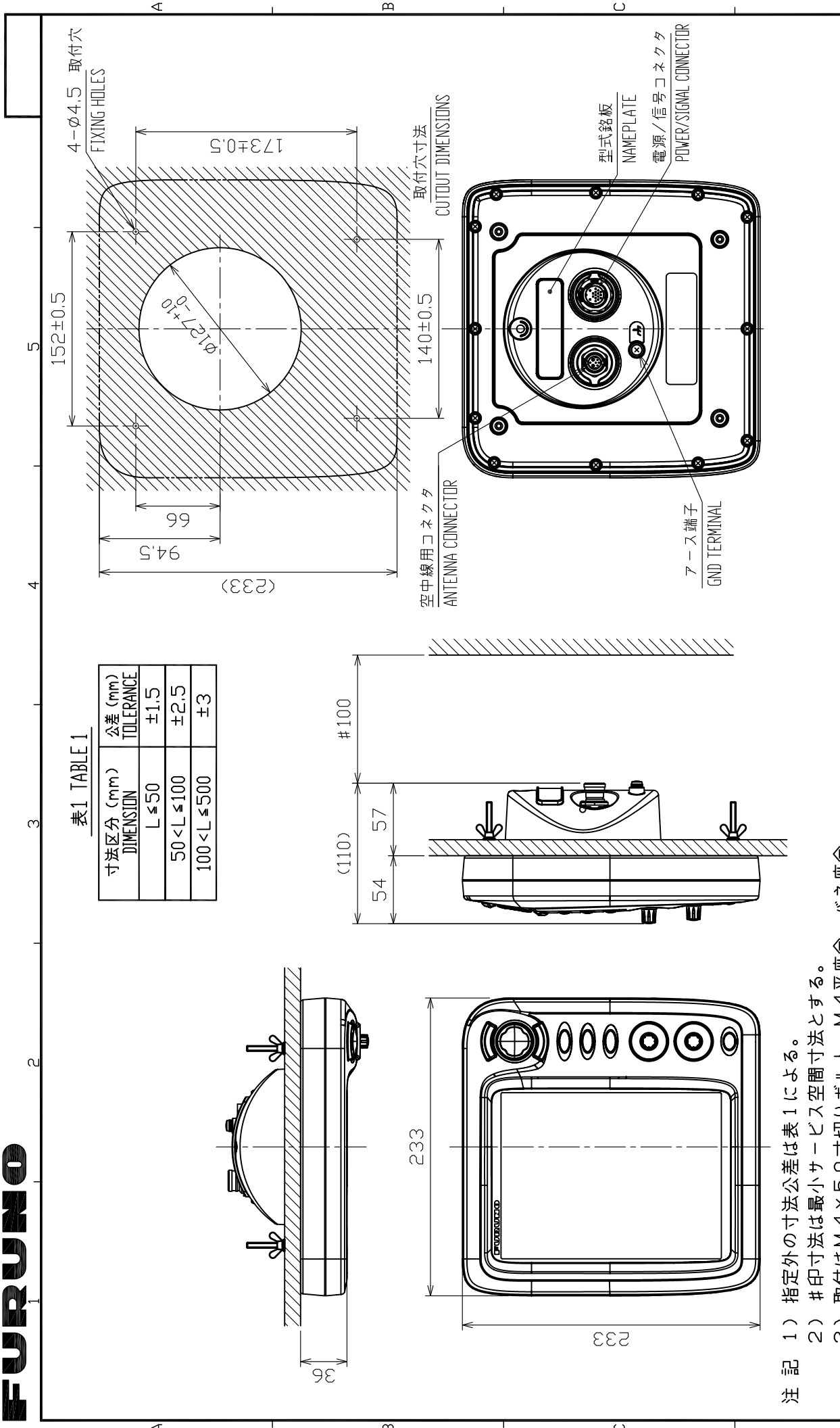
表 1 TABLE 1

寸法区分 (mm) DIMENSION	公差 (mm) TOLERANCE
$L \leq 50$	± 1.5
$50 < L \leq 100$	± 2.5
$100 < L \leq 500$	± 3

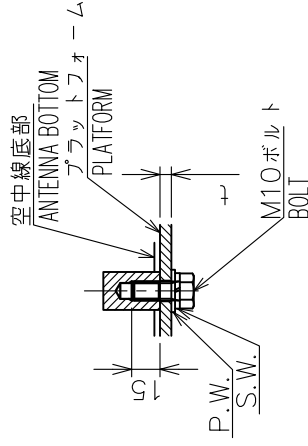
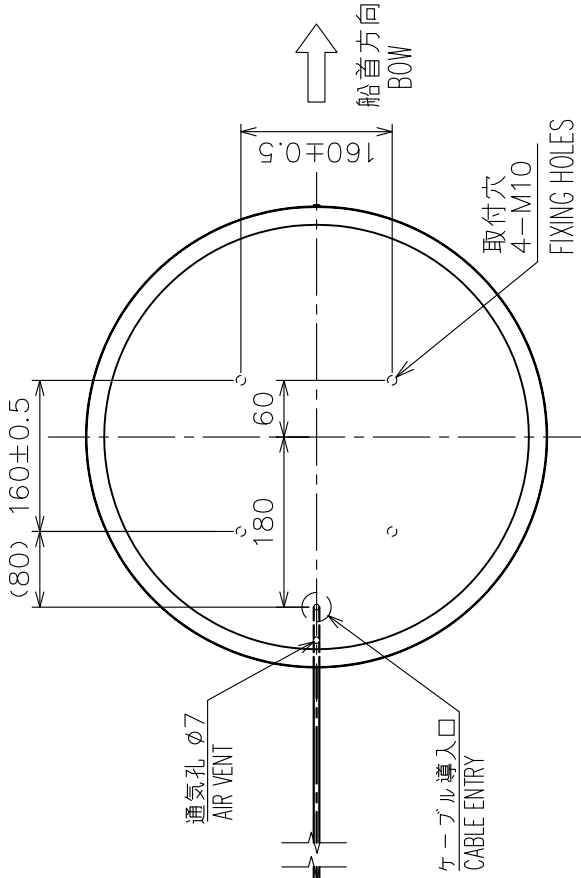

A 部 詳細 (尺度: 1/4)
DETAIL OF A (SCALE: 1/4)

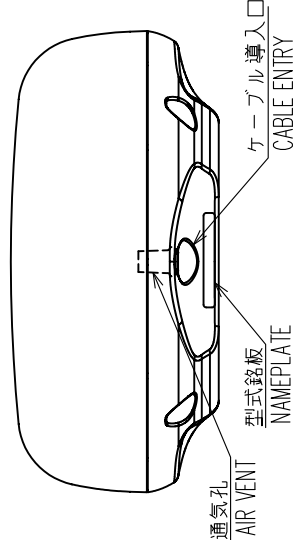
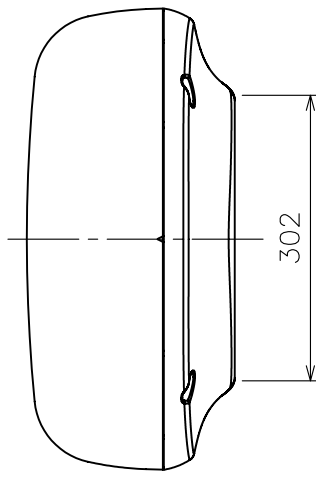
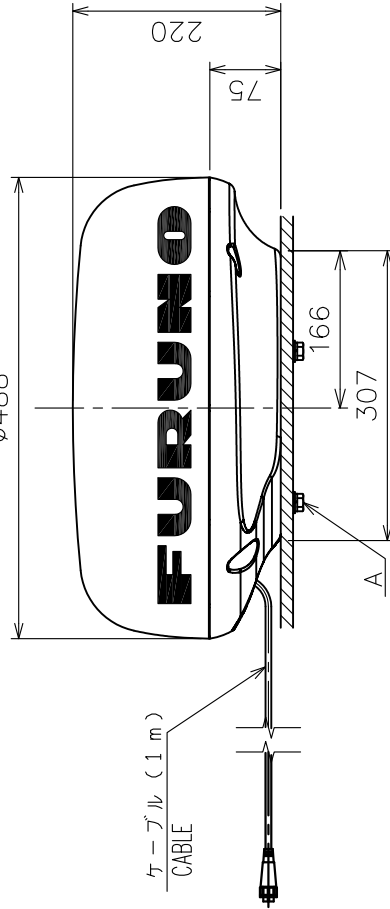

注 記

- 指定外の寸法公差は表 1 による。
- 取付用ネジは M10 ボルトを使用のこと。ネジ長さは板厚 (t) に応じ、 $20 (5 < t < 10)$ または $25 (5 < t < 10)$ とする。

NOTE

- TABLE 1 INDICATES TOLERANCE OF DIMENSIONS WHICH IS NOT SPECIFIED.
- USE M10 BOLTS FOR FIXING THE UNIT. SCREW LENGTH SHOULD BE $20 (t \leq 5)$ OR $25 (5 < t < 10)$. t: THICKNESS OF PLATFORM.

DRAWN	21/Aug/2017 I.YAMASAKI	TITLE	RSB-127-104/120
CHECKED	21/Aug/2017 H.MAKI	各種	レーダーセンサー
APPROVED	23/Aug/2018 H.MAKI	外寸図	
SCALE	1/8	質量はケーブル (1 m) を含む。 MASS INCLUDES 1m CABLE.	
DWG.No.	C3637-601-C	REF.No.	03-184-310G-1

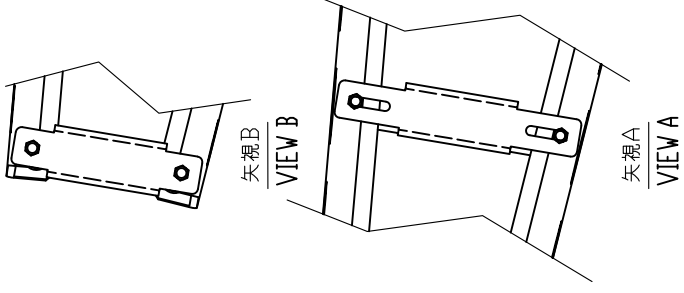
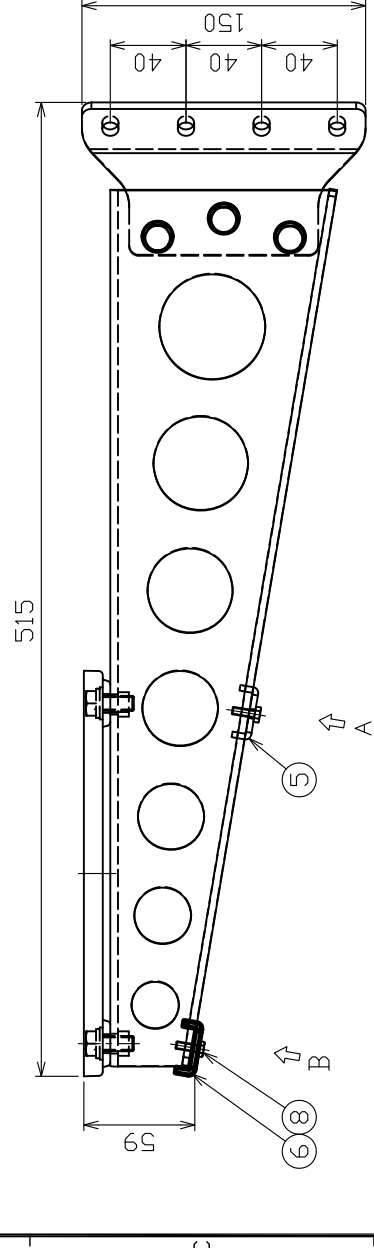
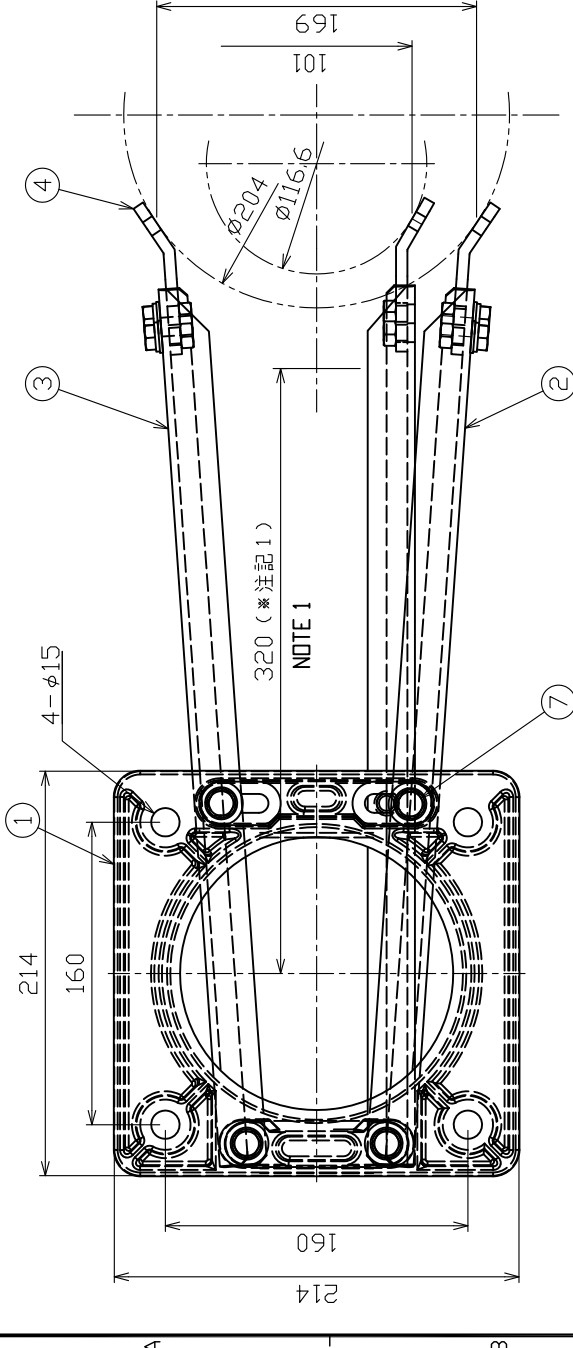

- 注 記**
- 1) マストに固定する場合、レドームスペース(320mm)にマストがかからないよう注意すること。
 - 2) 取付台のマスト固定寸法の可変範囲は101mmから169mmです。
 - 3) 塗装はVトップ N9.5 (白)

NOTE

1. KEEP CLEARANCE OF RADOME SPACE (320) FROM MAST.
2. FIXING HOLES PITCH ON MAST: 101 TO 169.
3. PAINT COLOR: N9.5 (WHITE).

8	六角ボルト セルス B HEX. BOLT (SEMS B)	SUS304	4	M4×12
7	六角ボルト セルス B HEX. BOLT (SEMS B)	SUS304	10	M8×20
6	支え板(2) FIXING PLATE (2)	A5052P	1	03-018-9006
5	支え板(1) FIXING PLATE (1)	A5052P	1	03-018-9005
4	取付金具 FIXTURE	SUS304	2	03-018-9004
3	アングル(2) ANGLE (2)	A5083P-□	1	03-018-9003
2	アングル(1) ANGLE (1)	A5083P-□	1	03-018-9002
1	取付台 BRACKET	AC4A-F	1	03-018-9001

品番 ITEM	品名 NAME	材質 MATERIAL	数量 QTY	図書 DWG No.	備 考 REMARKS
TITLE: OP03-208					
各種: レドーム取付台					
外寸図					
NAME: MOUNTING BRACKET					
OUTLINE DRAWING					
REF.No.	03-018-9000-1				

DRAWN	5/Mar/2020	T.YAMASAKI
CHECKED	5/Mar/2020	H.MAKI
APPROVED	6/Mar/2020	H.MAKI
SCALE	1/4	WASS - 30Z kg
DWG.No.	C3579-G03-A	

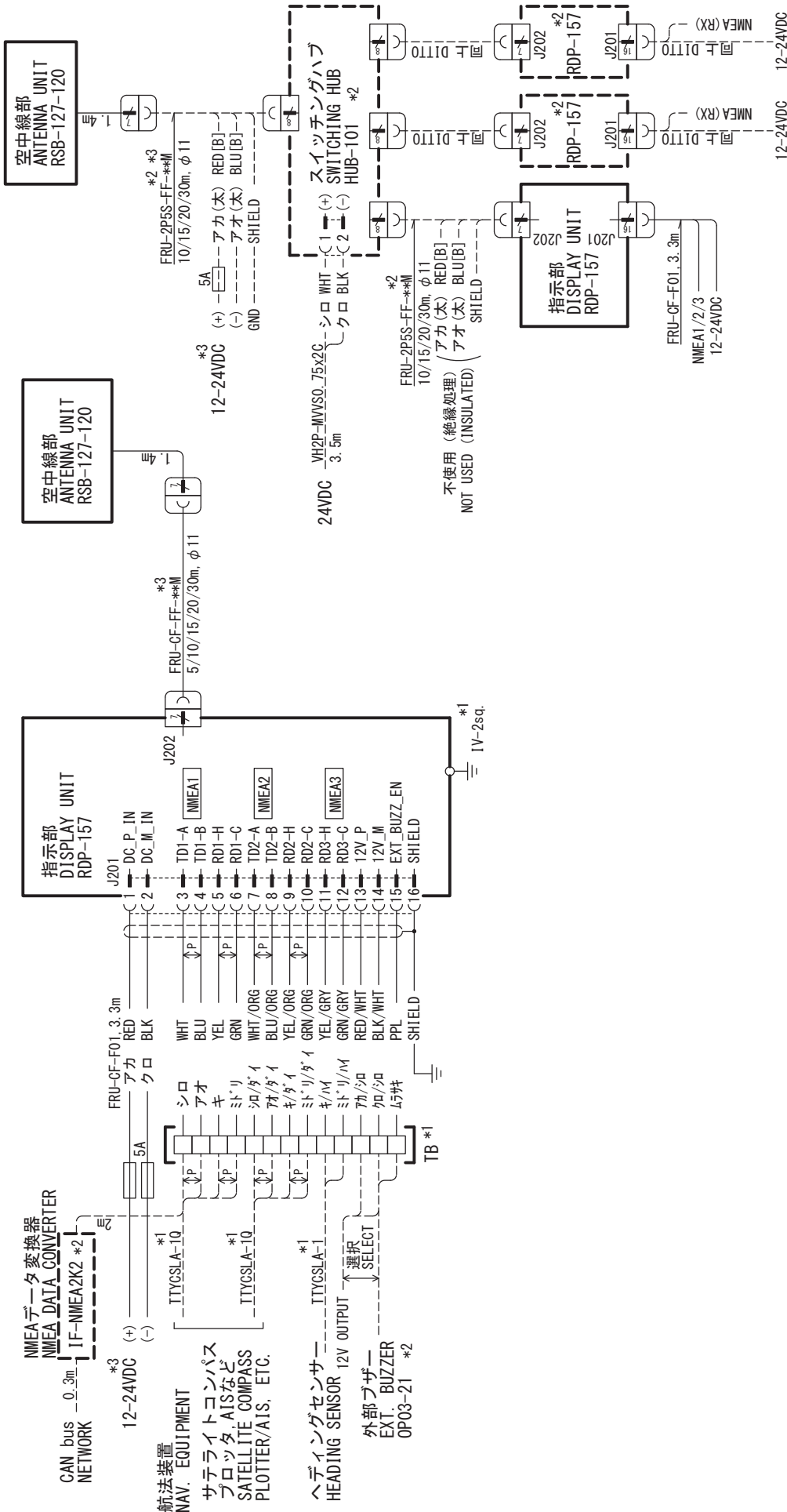

指示部は3台まで接続可
THREE DISPLAY UNITS AVAILABLE.

注記

- * 1) 造船所手配。
- * 2) オプション。
- * 3) 30mケーブル選択時はDC24Vが必要。

NOTE

- *1: SHIPYARD SUPPLY.
- *2: OPTION.
- *3: 24VDC SOURCE IS REQUIRED FOR 30m ANTENNA CABLE.

DRAWN	1/Oct/2018	T. YAMASAKI	TITLE	MODEL 1815
CHECKED	1/Oct/2018	H. MAKI	名称	船舶用レーダー
APPROVED	2/Oct/2018	H. MAKI	相互結線図	
SCALE	MASS	kg	NAME	MARINE RADAR
DWG. No.	C3666-C01-H	REF. No.	03-192-6001-2	INTERCONNECTION DIAGRAM

INDEX

A

AIS	
activating targets	5-3
controls for	5-1
CPA/TCPA alarm	5-8
display on/off	5-1
display range	5-5
display sector	5-5
lost target	5-9
number of targets	5-6
past position display	5-7
proximity alarm	5-9
sleeping targets	5-3
sorting targets	5-4
symbol color	5-10
symbols	5-2
target data	5-4
vector	5-6
vector reference	5-6
vector time	5-6
ALARM key	2-20
Alert list	AP-17
Alert status	2-36

B

Background color	2-38
Barge mark	2-34
Brill/Color menu	2-42

C

Character color	2-38
Cold start	6-4
Color	
background	2-38
characters	2-38
preset	2-38
Controls	2-1
Course up mode	2-8
CPA/TCPA alarm	
AIS	5-8
TT	4-8
Cursor	2-13

D

DATA BOX knob	2-45
Depth unit	2-44
Digital interface	AP-7
Display brilliance	2-4
Display menu	2-43
Display-curve	2-33

E

EBL	
measuring bearing by	2-17
reference	2-18
Echo area	2-39

Echo average	2-32
Echo color	2-38
Echo menu	2-43
Echo stretch	2-27

F

False echoes	3-3
FUNC key	2-31
Fuse replacement	7-2

G

Gain adjustment	2-10
Geodetic chart list	AP-5
GPS	
cold start	6-4
datum	6-1
navigator mode	6-1
satellite monitor	6-3
test	6-4
WAAS	6-2

H

Head up mode	2-8
Heading line erasure	2-14

I

Indications	2-3
Initial sub menu	2-39
Interference rejector	2-14

J

JIS cable guide	AP-14
-----------------	-------

L

LCD test	7-7
Lost target	
AIS	5-9
TT	4-4

M

Magnetron	7-3
Maintenance	
fuse replacement	7-2
magnetron	7-3
preventive	7-2
Menu overview	2-4
Menu tree	AP-1
Multiple echoes	3-3

N

Navigation data	2-45
Noise rejector	2-15
North up mode	2-8

O

Off-center	
automatic	2-24
custom	2-23
manual	2-23

- mode 2-23
- speed in automatic mode 2-24
- Origin mark 2-47
- Own ship mark 2-33
- P**
- Panel brilliance 2-4
- Past position display
 - AIS 5-7
 - TT 4-6
- POWER/BRILL key 2-2, 2-4
- Proximity alarm
 - AIS 5-9
 - TT 4-9
- R**
- RACON 3-8
- Radar sensor test 7-8
- Radio regulator information AP-15
- Rain clutter adjustment 2-12
- Range and bearing between two targets 2-19
- RANGE knob 2-10
- Range measurement
 - fixed range rings 2-15
 - VRM 2-16
- Range ring brilliance 2-15
- Range unit 2-44
- S**
- SART 3-6
- Satellite monitor 6-3
- Sea clutter adjustment 2-11
- Sector blank 2-41
- Shadow sector 3-5
- Ship speed unit 2-44
- Sidelobe echoes 3-4
- Specifications SP-1
- System configuration X
- System test 7-5
- T**
- Target alarm
 - alarm type 2-21
 - audio alarm silencing 2-21
 - deactivating 2-22
 - setting 2-20
 - sleeping 2-22
 - strength level 2-22
- Target trails
 - color 2-29
 - erase all trails 2-31
 - gradation 2-29
 - level 2-29
 - mode 2-28
 - narrow trails 2-30
 - own ship trail 2-30
 - restarting 2-29
 - time 2-27
- Temperature unit 2-44
- Tests
- GPS 6-4
- LCD 7-7
- radar sensor 7-8
- system 7-5
- TLL 2-47
- Troubleshooting
 - advanced-level 7-4
 - simple 7-3
- True motion mode 2-9
- True view mode 2-9
- TT
 - acquiring targets automatically 4-3
 - acquiring targets manually 4-2
 - controls for 4-1
 - CPA/TCPA alarm 4-8
 - display on/off 4-2
 - lost target 4-4
 - own ship vector 4-6
 - past position display 4-6
 - precautions 4-1
 - proximity alarm 4-9
 - stopping tracking 4-3
 - symbol color 4-2
 - target data 4-7
 - vector description 4-4
 - vector reference 4-5
- Tuning 2-6
- U**
- Units menu 2-44
- V**
- Vector
 - description, AIS 5-6
 - description, TT 4-4
 - own ship 4-6
 - reference, AIS 5-6
 - reference, TT 4-5
- Virtual image 3-4
- VRM
 - measuring range by 2-16
 - unit for 2-17
- W**
- Watchman 2-35
- Waypoint marker 2-46
- Wind speed unit 2-44
- Wiper 2-32
- Z**
- Zoom
 - non-tracked target 2-25
 - reference 2-24
 - TT or AIS target 2-26

Declaration of Conformity

[MODEL1815]

Bulgarian (BG)	<p>С настоящото Furuno Electric Co., Ltd. декларира, че гореспоменат тип радиосъоръжение е в съответствие с Директива 2014/53/ЕС. Цялостният текст на ЕС декларацията за съответствие може да се намери на следния интернет адрес:</p>
Spanish (ES)	<p>Por la presente, Furuno Electric Co., Ltd. declara que el tipo de equipo radioeléctrico arriba mencionado es conforme con la Directiva 2014/53/UE. El texto completo de la declaración UE de conformidad está disponible en la dirección Internet siguiente:</p>
Czech (CS)	<p>Tímto Furuno Electric Co., Ltd. prohlašuje, že výše zmíněné typ rádiového zařízení je v souladu se směrnicí 2014/53/EU. Úplné znění EU prohlášení o shodě je k dispozici na této internetové adrese:</p>
Danish (DA)	<p>Hermed erklærer Furuno Electric Co., Ltd., at ovennævnte radioudstyr er i overensstemmelse med direktiv 2014/53/EU. EU-overensstemmelseserklæringens fulde tekst kan findes på følgende internetadresse:</p>
German (DE)	<p>Hiermit erkläre die Furuno Electric Co., Ltd., dass der oben genannte Funkanlagentyp der Richtlinie 2014/53/EU entspricht. Der vollständige Text der EU-Konformitätserklärung ist unter der folgenden Internetadresse verfügbar:</p>
Estonian (ET)	<p>Käesolevaga deklareerib Furuno Electric Co., Ltd., et ülalmainitud raadioseadme tüüp vastab direktiivi 2014/53/EL nõuetele. ELi vastavusdeklaratsiooni täielik tekst on kättesaadav järgmisel internetiaadressil:</p>
Greek (EL)	<p>Με την παρούσα η Furuno Electric Co., Ltd., δηλώνει ότι ο προαναφερθέντας ραδιοεξοπλισμός πληροί την οδηγία 2014/53/ΕΕ. Το πλήρες κείμενο της δήλωσης συμμόρφωσης ΕΕ διατίθεται στην ακόλουθη ιστοσελίδα στο διαδίκτυο:</p>
English (EN)	<p>Hereby, Furuno Electric Co., Ltd. declares that the above-mentioned radio equipment type is in compliance with Directive 2014/53/EU. The full text of the EU declaration of conformity is available at the following internet address:</p>
French (FR)	<p>Le soussigné, Furuno Electric Co., Ltd., déclare que l'équipement radioélectrique du type mentionné ci-dessus est conforme à la directive 2014/53/UE. Le texte complet de la déclaration UE de conformité est disponible à l'adresse internet suivante:</p>
Croatian (HR)	<p>Furuno Electric Co., Ltd. ovime izjavljuje da je gore rečeno radijska oprema tipa u skladu s Direktivom 2014/53/EU. Cjeloviti tekst EU izjave o sukladnosti dostupan je na sljedećoj internetskoj adresi:</p>
Italian (IT)	<p>Il fabbricante, Furuno Electric Co., Ltd., dichiara che il tipo di apparecchiatura radio menzionato sopra è conforme alla direttiva 2014/53/UE. Il testo completo della dichiarazione di conformità UE è disponibile al seguente indirizzo Internet:</p>
Latvian (LV)	<p>Ar šo Furuno Electric Co., Ltd. deklarē, ka augstāk minēts radioiekārta atbilst Direktīvai 2014/53/ES. Pilns ES atbilstības deklarācijas teksts ir pieejams šādā interneta vietnē:</p>

Lithuanian (LT)	Aš, Furuno Electric Co., Ltd., patvirtinu, kad pirmiau minėta radijo įrenginių tipas atitinka Direktyvą 2014/53/ES. Visas ES atitikties deklaracijos tekstas prieinamas šiuo interneto adresu:
Hungarian (HU)	Furuno Electric Co., Ltd. igazolja, hogy fent említett típusú rádióberendezés megfelel a 2014/53/EU irányelvnek. Az EU-megfelelőségi nyilatkozat teljes szövege elérhető a következő internetes címen:
Maltese (MT)	B'dan, Furuno Electric Co., Ltd., niddikjara li msemmija hawn fuq-tip ta' tagħmir tar-radju huwa konformi mad-Direttiva 2014/53/UE. It-test kollu tad-dikjarazzjoni ta' konformità tal-UE huwa disponibbli f'dan l-indirizz tal-Internet li ġej:
Dutch (NL)	Hierbij verklaar ik, Furuno Electric Co., Ltd., dat het hierboven genoemde type radioapparaat conform is met Richtlijn 2014/53/EU. De volledige tekst van de EU-conformiteitsverklaring kan worden geraadpleegd op het volgende internetadres:
Polish (PL)	Furuno Electric Co., Ltd. niniejszym oświadczam, że wyżej wymieniony typ urządzenia radiowego jest zgodny z dyrektywą 2014/53/UE. Pełny tekst deklaracji zgodności UE jest dostępny pod następującym adresem internetowym:
Portuguese (PT)	O(a) abaixo assinado(a) Furuno Electric Co., Ltd. declara que o mencionado acima tipo de equipamento de rádio está em conformidade com a Diretiva 2014/53/UE. O texto integral da declaração de conformidade está disponível no seguinte endereço de Internet:
Romanian (RO)	Prin prezenta, Furuno Electric Co., Ltd. declară că menționat mai sus tipul de echipamente radio este în conformitate cu Directiva 2014/53/UE. Textul integral al declarației UE de conformitate este disponibil la următoarea adresă internet:
Slovak (SK)	Furuno Electric Co., Ltd. týmto vyhlasuje, že vyššie spomínané rádiové zariadenie typu je v súlade so smernicou 2014/53/EÚ. Úplné EÚ vyhlásenie o zhode je k dispozícii na tejto internetovej adrese:
Slovenian (SL)	Furuno Electric Co., Ltd. potrjuje, da je zgoraj omenjeno tip radijske opreme skladen z Direktivo 2014/53/EU. Celotno besedilo izjave EU o skladnosti je na voljo na naslednjem spletnem naslovu:
Finnish (FI)	Furuno Electric Co., Ltd. vakuuttaa, että yllä mainittu radiolaitetyyppi on direktiivin 2014/53/EU mukainen. EU-vaatimusten mukaisuusvakuutuksen täysimittainen teksti on saatavilla seuraavassa internetosoitteessa:
Swedish (SV)	Härmed försäkrar Furuno Electric Co., Ltd. att ovan nämnda typ av radioutrustning överensstämmer med direktiv 2014/53/EU. Den fullständiga texten till EU-försäkran om överensstämmelse finns på följande webbadress:

Online Resource

http://www.furuno.com/en/support/red_doc