



CAMINO-108

AIS Class B

USER MANUAL



Automatic Identification System

SVIB

COPYRIGHT

The entire contents of this instruction manual, including any future updates, revisions, and modifications, shall remain the property of AMEC at all times. Unauthorized copies or reproduction of this manual, either in part or whole, in any form of print and electronic media, is prohibited. The contents herein can only be used for the intended purpose of this manual.

DISCLAIMER

AMEC is devoted to publish and maintain this product manual. As we continue to improve our AIS products to satisfy all customers' needs, information in this document is subject to change without notice. AMEC does not make any representations or warranties (implied or otherwise) regarding the accuracy and completeness of this document and shall in no event be liable for any loss of profit or any commercial damage, including but not limited to special, incidental, consequential, or other damage.

Manual Revision: Version 1.20

WARNING!

WARNING: The transponder must be installed and configured in conformity with the provided instructions in the manual in order to maximize the device performance.

WARNING: Please bear in mind that not all vessels are equipped with AIS transponders and therefore may not be visible to this transponder. Likewise, certain conditions, such as device malfunction, the environment, improper use, and overcrowded port traffic, may exist whereby the vessel equipped with this AIS transponder is not visible to other AIS transponders.

WARNING: DO NOT DISASSEMBLE OR MODIFY THE EQUIPMENT. Improper disassembly or modification could cause personal injury and will invalidate the guarantee.

WARNING: While most of the installation can be performed by the owner or the crew, a final commissioning can be done by your local agent/dealer when needed or required. AMEC and the local agent/dealer will not bear any responsibilities over any damages resulted from improper installation by unauthorized agent/dealer.

FOR USERS IN THE UNITED STATES OF AMERICA ONLY

WARNING: It is a violation of the rules of the Federal Communications Commission to input an MMSI that has not been properly assigned to the end user, or to otherwise input any inaccurate data in this device.

- ★ The entry of static data into this device shall be performed by the vendor of the device or by an appropriately qualified person in the business of installing marine communications equipment on board vessels.
- ★ Instructions on how to accurately enter and confirm static data in the device can be found in this user manual.

FOREWORD

AMEC thanks you for the purchase of your new CAMINO-108 Automatic Identification System (hereinafter called "AIS"). Wherever you sail now, you can have a better control of your surrounding sea, and have an enjoyable voyage.

CAMINO-108 is strictly tested at the factory to meet the rigorous demands of the marine environment. With proper use, installation, and maintenance, the equipment will serve loyally and reliably at its optimum.

For sales, services, and technical supports, please contact your local AMEC representatives or Alltek Marine Electronics Corp at sales@alltekmarine.com or service@alltekmarine.com. You are always welcome to visit our website at www.alltekmarine.com for new product status and company update.

Thank you again. Be safe.

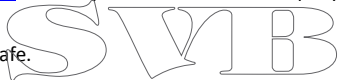

TABLE OF CONTENT

1	SYSTEM OVERVIEW	8
1.1	PRODUCT DESCRIPTION	8
1.2	EQUIPMENTS IN THE BOX	10
1.3	EXTERNAL CONNECTIONS	11
1.4	WHAT IS AIS?	12
1.4.1	Class A vs. Class B AIS	14
1.4.2	AIS Message Types	15
1.4.3	AIS Report Rate	15
2	INSTALLATION	16
2.1	INSTALLATION PROCEDURES	16
2.2	MOUNTING TRANSPONDER MAIN UNIT	17
2.3	VHF/GPS ANTENNA INSTALLATION	19
2.4	GPS ANTENNA LOCATION	20
2.5	CONNECTING POWER AND DATA CABLE	21
2.6	CONNECTING WITH NMEA 0183 DEVICES	23
2.7	AIS SILENT MODE CONNECTION	26
2.8	CONNECTION TO NMEA 2000 NETWORK	26
2.9	CONNECTING TO POWER SUPPLY	27
3	CONFIGURING YOUR CAMINO-108	28
3.1	ESTABLISH CONNECTION TO YOUR PC	28
3.1.1	Serial Port Connection	28
3.1.2	Wireless Connection (only for CAMINO-108W)	30
3.2	PROGRAMMING YOUR VESSEL DATA	30
3.3	TRANSCEIVER SETTING	32
3.4	BAUD RATE SETTING	33
3.5	DIAGNOSIS FUNCTIONS	35

3.5.1	System Check.....	36
3.5.2	GPS Status	37
3.5.3	Data Log.....	38
4	GET STARTED	39
4.1	START UP THE TRANSPONDER	39
4.2	LED INDICATORS	40
4.3	SD CARD DATA LOGGING.....	42
4.4	WI-FI CONFIGURATION (CAMINO-108W ONLY)	43
4.5	BUILT-IN INTEGRITY TEST (BIIT)	44
4.6	AIS VIEWER DESCRIPTION.....	45
4.7	CONNECTING YOUR TRANSPONDER TO MACINTOSH	46
4.8	INTRODUCING AMEC AIS APP	46
5	SPECIFICATIONS	47
5.1	PRODUCT SPECIFICATIONS.....	47
5.2	DIMENSIONS	50
5.3	NMEA 2000 PGN INFORMATION	51
5.4	SUPPORTED NMEA 0183 SENTENCES	53
6	TROUBLESHOOTING.....	54
7	ABBREVIATIONS.....	57
8	FCC INTERFERENCE STATEMENT	58
9	RF EXPOSURE WARNING	59
	DECLARATION OF CONFORMITY	60
	AMEC WORLDWIDE WARRANTY	60
	APPENDIX: HOW TO DETERMINE SERIAL PORT.....	62

1 System Overview

1.1 Product Description

The AMEC CAMINO-108 AIS Class B Transponder series is perfect for smaller vessels, where the complexity of a Class A Transponder is not necessary. It transmits the vessels dynamic and static data in a typical 7 NM range as well as receives AIS targets typically within 20 NM around the boat. Using the built-in GPS receiver, the CAMINO-108 determines position, speed and course, and once this is combined with other navigational information, it is automatically transmitted without any user interaction. When received by other vessels and coast stations, the data built up will provide a live graphical display of traffic in the area. The CAMINO-108 has been engineered for flawless integration with navigation systems, and supports NMEA 2000 and NMEA 0183 communications, and its output meets IEC 62287 and related standards.

The CE/BSH approved CAMINO-108 also features USB connectivity and an optional Wi-Fi interface (CAMINO-108W). The SD card slot in the CAMINO-108 can be quickly and easily used as a data recorder, enabling the capture of all messages - to assist in system and safety monitoring, including incident investigation. The recorded data is logged and stored on the SD card when fitted. An optional switch box enables 'Silent' mode allowing the user to stop the broadcast of static and dynamic information on occasions where either privacy or security is required.

CAMINO-108

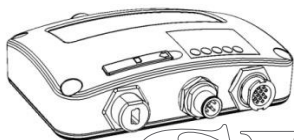

Front

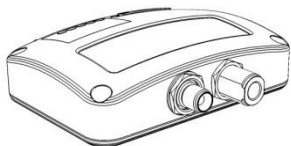

Back

CAMINO-108W

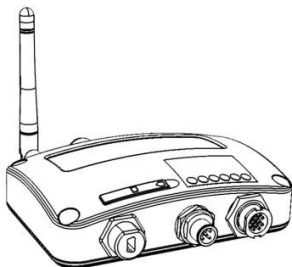

Front

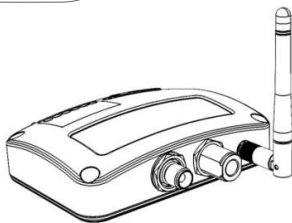

Back

1.2 Equipments in the Box

Upon receiving the product please verify items in the box. If any is missing, please contact your local AMEC representative immediately.



Class B AIS Transponder



12pin cable with power,
dual NMEA0183, silent mode,
1m, 26AWG

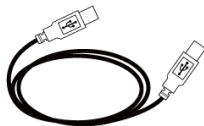

Mini USB to USB
cable, 1.8m



User Manual



Software CD: configuration utility,
USB driver, AIS Viewer, user manual

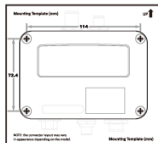

Mounting Template

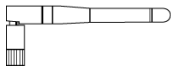

Wi-Fi antenna (108W only)



M3.5x25 Screws

Optional Accessory

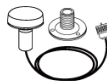

GPS antenna ANT-21
with 10m cable

1.3 External Connections

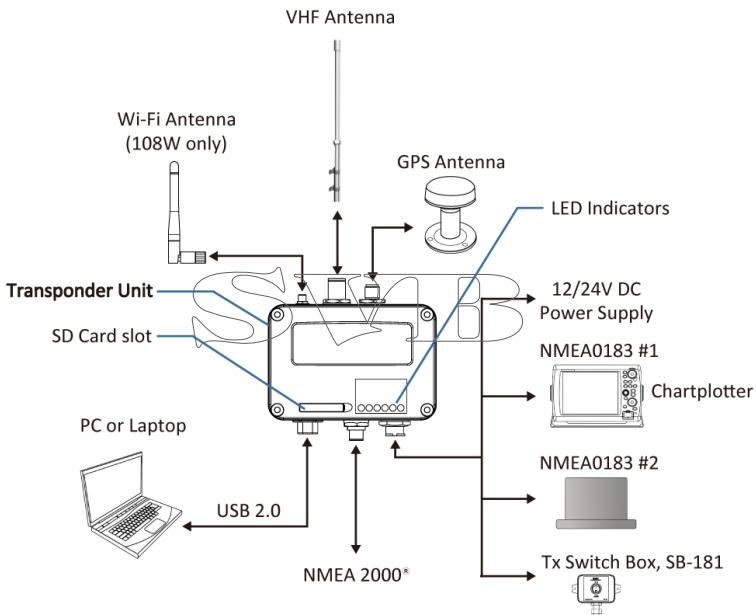

1.4 What is AIS?

The Automatic Identification System (AIS) is a Very High Frequency (VHF) radio broadcasting system that transfers packets of data over the VHF data link (VDL) and enables AIS equipped vessels and shore-based stations to exchange identification information and navigational data. Ships with AIS transponders continually transmit their ID, position, course, speed and other data to all nearby ships and shore stations. Such information can aid greatly in situational awareness and provide a means to assist in collision avoidance.

AIS equipment is standardized by ITU, IEC, IALA and IMO and is subject to approval by a certification body. The following AIS devices have been developed for variant applications.

- **AIS Class A:**

mandated by the IMO for vessels of 300 gross tonnages and upwards engaged on international voyages, cargo ships of 500 gross tonnages and upwards, as well as passenger ships. It transmits typically on 12.5 watt output power.

- **AIS Class B:**

provides limited functionality and is intended for non-SOLAS commercial vessels and recreational vessels. It transmits typically on 2 watt output power.

- **AIS Receiver:**

only receives AIS signal and it does not have transmitter to send out AIS signal. Suitable for recreational vessel that does not want to send out its vessel information.

- **AIS Base Station:**

is provided by aids-to-navigation authorities to enable the ship to shore / shore to ship transmission of information. Networked AIS Base Stations can assist in providing overall maritime domain awareness.

- **AIS AtoN (Aids to Navigation):**

provides an opportunity to transmit position and status of buoys and lights through the same VDL, which can then show up on AIS-ready devices within the range.

- **AIS SART:**

Search and Rescue Transmitter using AIS can be used to assist in determining the location of a vessel in distress. It is typically used on life rafts.

- **AIS on Search and Rescue (SAR) Aircraft:**

used on airplanes and helicopters to assist search and rescue operation.

1.4.1 Class A vs. Class B AIS

A brief comparison of class A and class B AIS is illustrated in the following table. CAMINO-108 is a class B AIS transponder.

Table 1-1 Comparison of Class A and Class B

Type of AIS	Class A AIS	Class B AIS
Communication Protocol	SOTDMA (Self-organizing)	CSTDMA (Carrier-Sense)
Transmit Power and range	12.5w (25 NM expected)	2w (5-7 NM expected)
IMO Mandate	Mandatory for all SOLAS compliant vessels	No mandate
Reporting rate dynamic data	Higher (transmission up to every 2 sec)	Lower (transmission up to every 30 sec)
AIS data presented	Static, Dynamic, Voyage	Static and Dynamic data
Applications	Commercial vessels, fishing boats, working boats, passenger boats with more than 12 passengers	Recreational vessels and small fishing boats

1.4.2 AIS Message Types

Class B AIS broadcasts following message types:

Static Data:

- MMSI
- Vessel name
- Vessel call sign
- Type of ship
- Ship dimensions / GPS antenna location

Dynamic Data:

- Position of the vessel
- Course over ground (COG)
- Speed over ground (SOG)
- True heading



1.4.3 AIS Report Rate

Class B AIS broadcasts ship dynamic data per following reporting interval. Besides, ship static data will be broadcasted every 6 minutes.

Ship Condition	Nominal Reporting Interval
Ship not moving faster than 2 knots	3 Minutes
Ship moving faster than 2 knots	30 Seconds

2 Installation

2.1 Installation Procedures

Please familiarize the manual content before begin installation. Depending on your hardware configuration, use the following recommended steps for installation.

- 1) Mount the transponder unit to an appropriate location
- 2) Install VHF antenna
- 3) Install GPS antenna
- 4) Connect antenna cables to the transponder
- 5) Connect to a chartplotter via NMEA 0183 or NMEA 2000 interface if applicable
- 6) Make silent mode connection if applicable (optional external switch needed)
- 7) Connect to an appropriate power source (12V / 24V DC, 2A)
- 8) Power On the power source (which turns on the transponder unit)
- 9) Program MMSI and vessel information into the device using configuration software before installation (please refer to chapter 3)
- 10) Perform LED checking and system functional test

2.2 Mounting Transponder Main Unit

The following guidelines should be noticed when selecting the environment to install your AMEC CAMINO-108:

- Do not install the AIS transponder in a flammable or hazardous atmosphere such as in an engine or generator room or close to fuel tanks.
- Installation of the transponder should be undertaken in a safe environment without being exposed to any splashing water or rain.
- There should be adequate space around the AIS transponder for routing of cables. See figure below for details of the AIS transponder dimensions.
- The safe distance of the transponder to any magnetic compass is at least 0.55m.
- The operating temperature is between -15°C and $+55^{\circ}\text{C}$.
- The AIS transponder can be installed and mounted on flat surface, or it can be mounted on wall with the four self tapping screws supplied.
- The device should be mounted in a location where the indicators can readily be observed as these indicators deliver relevant information on the status of the AIS transponder.

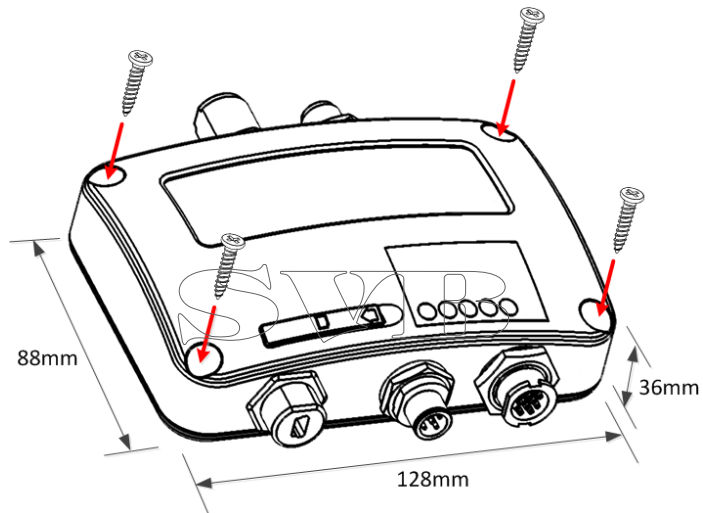

Figure 1 Mounting the transponder

2.3 VHF/GPS Antenna Installation

The quality and positioning of the antenna are the most important factors dictating AIS performance. It is recommended that a VHF antenna with omnidirectional vertical polarization be specifically tuned for AIS operation band. Since the range of VHF signals is largely decided by line of sight distance, the VHF antenna should be placed as high as possible and at least 5 meters away from any constructions made of conductive materials. It is recommended to keep the VHF antenna at least 3 meters away from the GPS antenna.

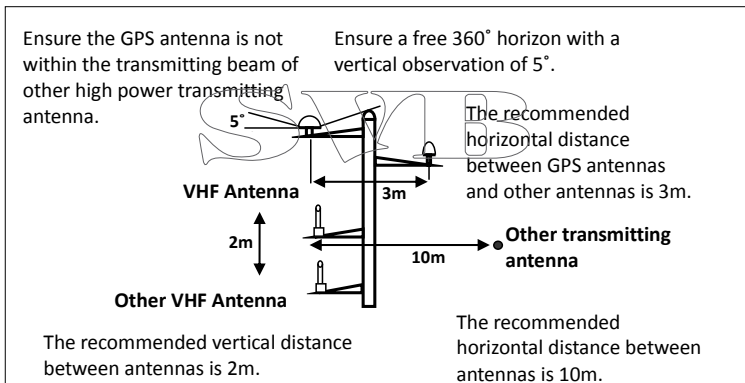

Figure 2 VHF/GPS antenna locations

WARNING: The safe distance from a transmitting VHF antenna is 60cm.

2.4 GPS Antenna Location

The ANT-21 GPS antenna must be installed where it has a clear view of the sky, so that it may access the horizon freely with 360° degrees, with a vertical observation of 5 to 90 degrees above the horizon as illustrated in the figure above.

Enter the GPS antenna location data in “SHIP SETTING” in the configuration utility after the installation. Following is the GPS antenna location offsets.

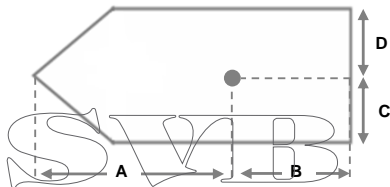

Figure 3 GPS antenna location

When connecting the cables, take note of the following precautions.

- Bending cables may cause damages to the inner wires and impair overall the performances.
- Each coaxial cable should be set up separately and can only be set up in a single cable tube.
- Insulation on connector port of the coaxial cable should be considered.

2.5 Connecting Power and Data Cable

Connecting the CAMINO-108 to external power source and data equipments are illustrated in diagram below.

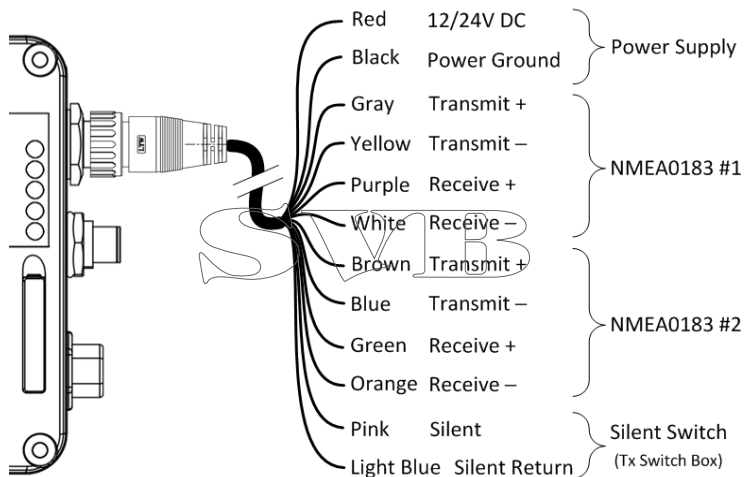

Figure 4 Wiring instructions

When wiring NMEA 0183 to AIS-ready equipment, please refer to your equipment manual first.



CAMINO-108W supports only one configuration baud rate configuration for Tx/Rx on NMEA 0183 port #2.



During installation, you may have to peel off some wires to make the appropriate connections. After completing the installation, please cover all exposed wires with a rubber-vulcanized tape to prevent the devices from malfunctioning or short-circuited.

SVMB

2.6 Connecting with NMEA 0183 Devices

CAMINO-108 has two NMEA 0183 ports and each NMEA 0183 port's transmitting and receiving interface can be configured to 4800, 9600, or 38400 baud rate independently. The default baud rate for both ports is 38400-bps. Use the provided configuration utility to change baud rates. Typically the high speed setting is used primarily for chart plotter connection, while the low speed setting can be used to connect to other NMEA 0183 compatible sensors.

CAMINO-108 NMEA 0183 supports multiplexer function. The received NMEA 0183 data from both ports will be multiplexed and forwarded to all output ports as illustrated in the following figure. The NMEA 2000 supports only GPS output messages.

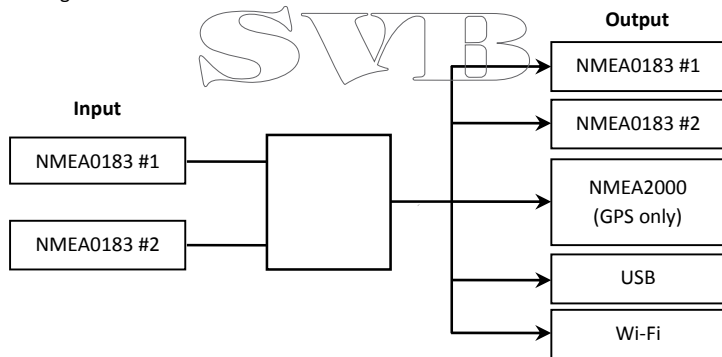

Figure 5 NMEA 0183 Multiplexer Function



Figure 6 NMEA 0183 Connection illustration

NMEA 0183 Signal (CAMINO-108)	Signal Direction (CAMINO-108)	External NMEA 0183 Device
Receive + (RXP)	Input	n/a
Receive - (RXN)	Input	n/a
Transmit + (TXP)	Output	Data Input + (RXP)
Transmit - (TXN)	Output	Data Input - (RXN)



Note: It is not recommended to connect the CAMINO-108 directly to RS232 devices over NMEA 0183. However, when RS232 devices are needed, please follow the instruction at www.alltekmarine.com under CAMINO-108's FAQ

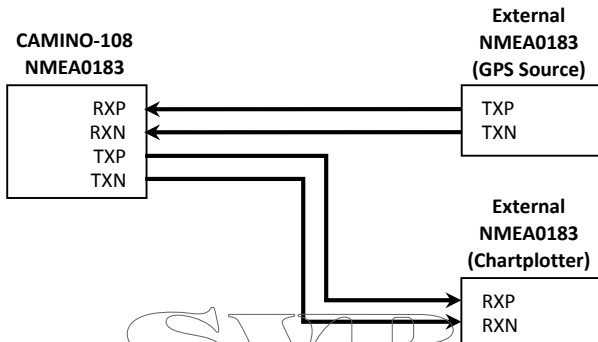

Figure 7 NMEA 0183 Multiplexing Connection

NMEA 0183 Signal (CAMINO-108)	Signal Direction (CAMINO-108)	External NMEA 0183 Devices
Receive + (RXP)	Input	Data Output + (TXP)
Receive - (RXN)	Input	Data Output - (TXN)
Transmit + (TXP)	Output	Data Input + (RXP)
Transmit - (TXN)	Output	Data Input - (RXN)

2.7 AIS Silent Mode Connection

If you require Silent Mode feature, it is possible to connect an external toggle switch to CAMINO-108. Connect the toggle switch between the pink and light blue wires to enable Silent Mode function, as depicted in Figure 4. An optional external Tx Switch Box (part number SB-181) is available from AMEC to turn on/off the AIS transmission.

2.8 Connection to NMEA 2000 Network

The CAMINO-108 is equipped with NMEA 2000 interface with LEN=1. CAMINO-108 is able to send **AIS** data and forward received **GPS** data (from NMEA 0183) via NMEA 2000 network to other NMEA 2000 devices. For further applications, please refer to supported PGN in 5.4. An updated PGN list is available at AMEC website under FAQ for CAMINO-108.

A compatible T-connector and drop cable available by your local service partner are needed to connect the class B transponder to your chart plotter with NMEA 2000 interface:

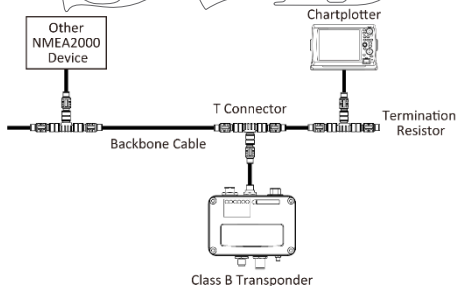

Figure 8 NMEA 2000 Network

2.9 Connecting to Power Supply

The CAMINO-108 requires a 12V or 24V DC power supply (9.6 to 31.2V) capable of supplying 2A peak current. The red wire and the black wire on the 12 pin cable are used to connect the power supply's positive and negative terminals. Practically, it is suggested to use the fuse panel before connecting directly to the battery/power supply.

SVMB

3 Configuring Your CAMINO-108

The AMEC AIS Configuration software enables the user to set up the transponder by entering your own ship's information. It also provides the facilities to monitor and diagnose your transponder from your PC/Laptop.

The AMEC AIS Configuration software can be found on the CD supplied. To install the configuration software, follow the installation instructions below.

Open the AMEC AIS Configuration file on the CD and click on the setup  icon to start the installation process. Follow the on screen instructions to complete the installation and check the checkbox to start the AMEC AIS Configuration Software at the end of the installation.

3.1 Establish Connection to your PC

3.1.1 Serial Port Connection

The USB driver has to be installed before linking the transponder to your PC. A PC/laptop can also be a convenient platform to display AIS targets with compatible software like the AIS Viewer supplied.

Required Items

- USB Driver (included in the software CD)
- USB cable (included in the box)
- PC/Laptop with Windows operating system (not included). CAMINO-108 USB Driver supports Windows XP, Windows Vista, Windows 7, Windows 8/8.1 and Windows 10.
- One available USB port on PC/Laptop
- Available CD-ROM drive on PC/Laptop

USB Driver Installation

With the transponder power on and the USB cable attached, plug in the USB cable to the PC/Laptop. A new hardware found prompt will show up. Follow the on screen instructions and assign the correct file path of the USB driver to complete the installation. You can also install the USB driver via the Device Manager in the Control Panel.

Detailed USB driver installation instructions including Windows 10 platform are supplied on the CD with the USB driver.

Once the USB driver is installed, launch the Configuration Software, select Option in the menu bar, then Connection, and “serial port”. There are 2 options to connect the software with your transponder:

- **Auto:** The system will scan all connected ports and their available baud rates and establish connection automatically.
- **Manual:** Configure baud rate and port manually. The default baud rate is 115200. To determine serial port with which the transponder is connected, please refer to Appendix in this manual.

Click on “**Connect**”, to connect the Configuration Software with your transponder.

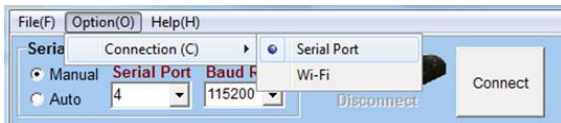

Figure 9 Serial port connection

3.1.2 Wireless Connection (only for CAMINO-108W)



Figure 10 Wi-Fi connection for CAMINO-108W

For CAMINO-108W, the connection between the Configuration Software and your transponder can also be established wirelessly. Please refer to 4.4 “Wi-Fi Configuration” about how to access CAMINO-108W from your PC as a hotspot.

After your PC is wirelessly connected with the transponder, go to Option in the menu bar, then Connection, and “Wi-Fi”. The IP address and Port are already preprogrammed to fit CAMINO-108W’s configuration. Click on **“Connect”**, to connect the Configuration Software with your transponder.

3.2 Programming your vessel data

After the transponder is successfully connected with the Configuration Software, click on the “STATIC DATA” tab. You will require the following information in order to configure your AIS transponder:

- Vessel name: limited to 20 characters
- Call sign: limited to 7 characters
- MMSI: Enter your MMSI (Maritime Mobile Service Identity) number
- Vessel type: choose your ship type from the drop down list

- Ship dimensions: Enter the vessel dimensions and position of your GPS antenna installation



WARNING: The MMSI number can only be entered once. Be sure to enter the correct MMSI number, as it cannot be corrected if entered incorrectly.

File(F) Option(O) Help(H)

Serial Port and Baud Rate Setting

Manual Serial Port Baud Rate

10 115200

Connected Disconnect EXIT

Configuration Diagnosis

STATIC DATA TRANSCEIVER BAUD RATE

NAME BALU

CALLSIGN AMEC101

MMSI 123456790

Ship Type 37 = Vessel-Pleasure craft 37

SHIP DIMENSION

0 (0-511m)

0 (0-511m)

0 (0-63m) 0 (0-63m)

Firmware Version: V1.2.6.1

Config Device Read Device

Figure 11 Static Data Setting

3.3 Transceiver Setting

- (1) To disable DSC monitoring function, select the “OFF” button. The default setting is “ON” (DSC enabled).
- (2) To disable the GPS output, check and select the “OFF” button. The default setting is “5 seconds” (GPS enabled).
- (3) GPS mode: the option “Altitude higher than 500m” enables GPS positioning at an altitude over 500m. The default setting is “At sea level”.
- (4) ALR Sentence: default setting is on. The OFF option enables users to deactivate alarm which will be typically triggered when COG or HDG data is no more available.

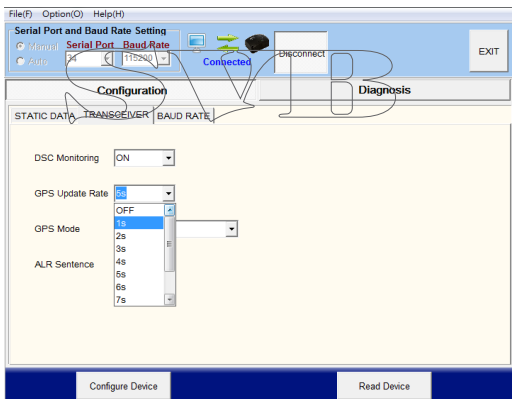

Figure 12 Transponder Setting

3.4 Baud Rate Setting

- (1) Click on “BAUD RATE” tab.
- (2) The default baud rate for NMEA is 38400. Enter the baud rate of connected devices. For NMEA 0183, CAMINO-108 supports baud rates 38400, 9600 and 4800.

The both NMEA 0183 ports of CAMINO-108 can be configured individually. For CAMINO-108W, only the first NMEA port has individual configuration. The 2nd NMEA port shares the same baud rate.

Click on  to confirm and complete the setting.

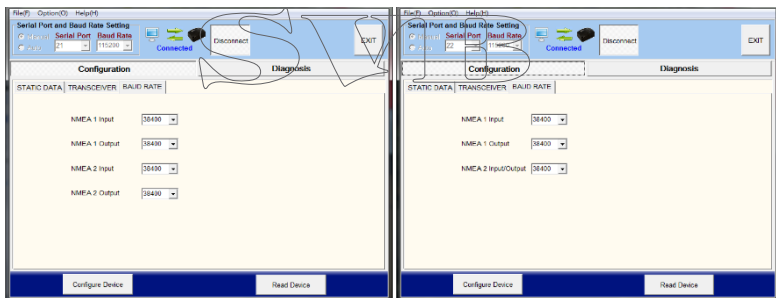

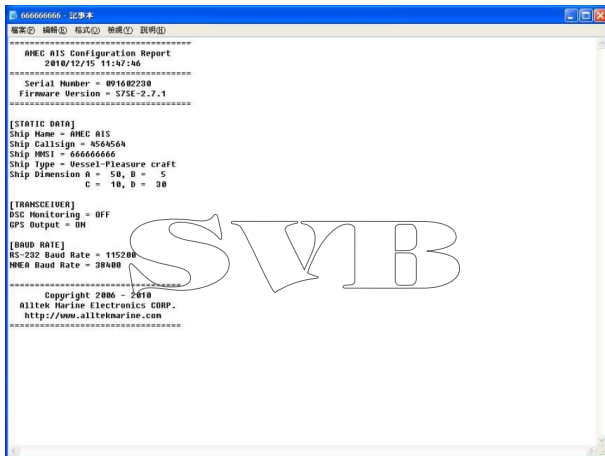

Figure 13 Baud Rate Setting CAMINO-108 (left) and 108W (right)

- (3) To read the device information, click on . A Configuration Report will pop-up in Notepad or an application that is associated for text file format.



```
-----
AHEC AIS Configuration Report
2010/12/15 11:47:46
-----
Serial Number = 891682238
Firmware Version = S7SE-2.7.1
-----

[STATIC DATA]
Ship Name = AHEC AIS
Ship CallSign = 4564564
Ship MMSI = 466666666
Ship Type = Vessel-Pleasure craft
Ship Dimension A = 50, B = 5
                C = 10, D = 30

[TRANSCIVER]
DSC Monitoring = OFF
GPS Output = ON

[BAUD RATE]
RS-232 Baud Rate = 115200
NMEA Baud Rate = 38400
-----

Copyright 2006 - 2010
Alltek Marine Electronics CORP.
http://www.alltekmarine.com
-----
```

Figure 14 Configuration Report

3.5 Diagnosis Functions

The second part of the AMEC AIS Configuration software utility features diagnosis functions. This function should be performed only after the device and antennas are all fully installed. Click on the Diagnosis tab to proceed for System Check, GPS Status, and Data Log.

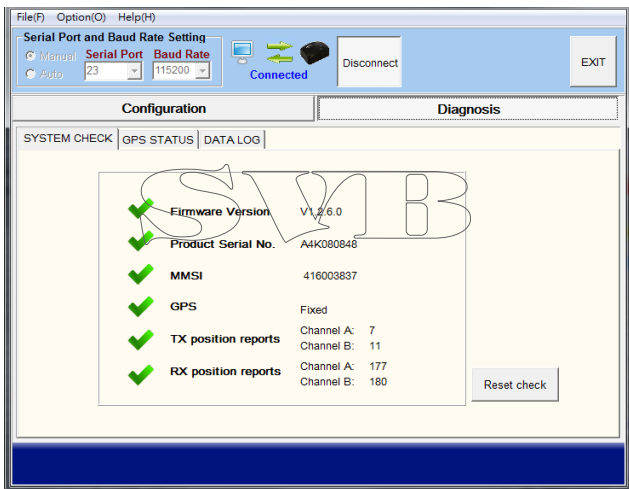
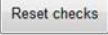

Figure 15 System Check

3.5.1 System Check

The System Check function can be used to check the Firmware Version, Serial Number, MMSI, GPS status, AIS TX report count, and AIS RX report count of the device. This function starts upon the connection of the device when powered on.

To recheck all status, click on  button.

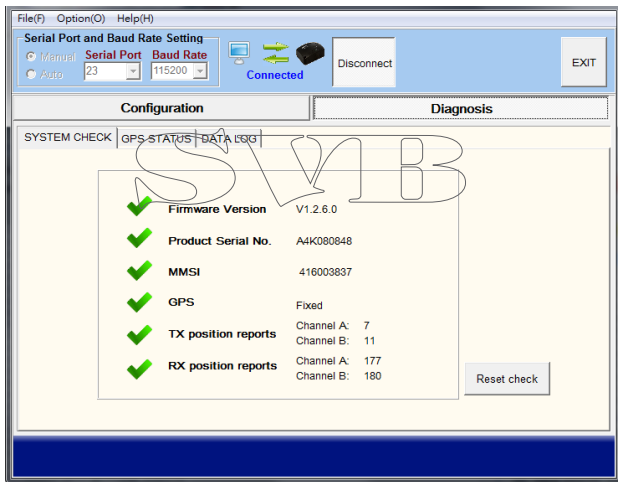

Figure 16 System Check

3.5.2 GPS Status

This tab shows the GPS status and the connectivities of all GPS satellites being used.

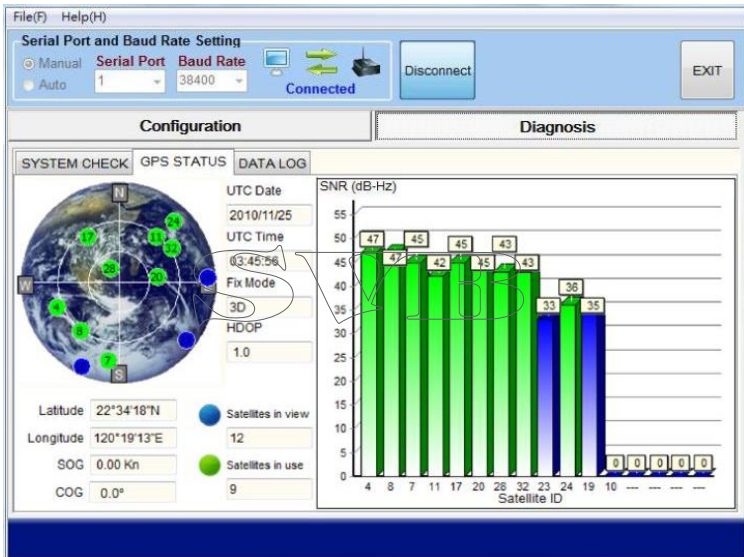

Figure 17 GPS Status

3.5.3 Data Log

The log shows the collected AIS data log from the device. You may save or clear the current collected log.

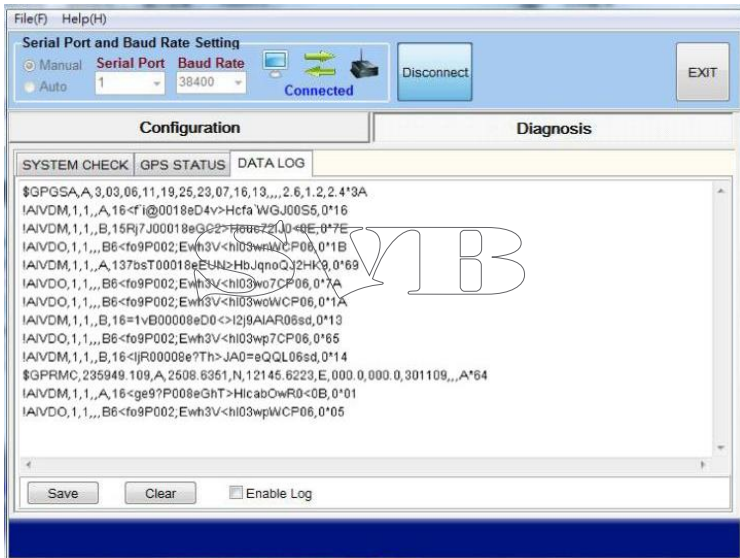



Figure 18 Data Log

4 GET STARTED

4.1 Start up the Transponder

The transponder will start up whenever the connected power source is ON. It will operate automatically if the transponder has been properly configured using the Configuration Software and GPS/VHF antennas are also properly installed. Normally the transponder should transmit its own ship positions every 30 seconds or 3 minutes depending on the moving speed. It should also receive other vessels' information in the vicinity.

The operation status of the transponder can be checked from the LED lights on the unit. Description of the LED indications is provided in the following section.

The logo consists of the letters 'S', 'V', 'M', and 'B' in a stylized, outlined font. The 'S' is on the left, followed by 'V', 'M', and 'B' to its right. The letters are interconnected and have a decorative, slightly irregular appearance.

4.2 LED Indicators

Indicator	Light	Description
Power	Green, steady	The transponder has been powered up correctly.
Error	Red, steady	MMSI is not properly programmed
	Red, flashing	The transponder has detected a BIIT system error. Please refer to Chapter 4.5 Built-In Integrity Test for detailed explanation.
Rx	Green, flashing	The transponder is receiving AIS data.
Tx/Silent	Orange, flashing	The transponder is acquiring a GPS fix, no AIS transmission during this time period. This can be the following situation: <ul style="list-style-type: none">• The device is just newly powered on and is acquiring a GPS position fix prior to transmitting its first vessel information report. This process may take several minutes.• The GPS position fix has been lost. The device is attempting to re-acquire position fix for 30 minutes before entering a BIIT system error state.

Tx/Silent	Orange, steady	The transponder is in silent mode, no AIS transmission at all.
	Green, flashing	The transponder is transmitting AIS data. The flash interval is 3 minutes when vessel speed under 2 knots. The flash interval is 30 seconds when vessel speed above 2 knots.
SD	Green, flashing	SD card is being accessed.
	Green, steady	SD card is full. Replace with another empty SD card or delete files to obtain free spaces.
Wi-Fi (108W only)	Green, flashing	The green LED indicates an active Wi-Fi traffic

4.3 SD Card Data Logging

The CAMINO-108 records voyage data onto a SD card in .txt format. The compatible SD card types are listed as followed:

- Standard “SD” with maximum 2GB size
- Standard “SDHC” with maximum 32GB size
- Supported data format: FAT12/16 by SD, FAT32 by SDHC

Please insert the SD card into the slot as shown below before powering on the transponder. After the transponder is switched on, it will commence logging voyage data and indicates the writing process by flashing the green SD LED indicator.

The log files have naming convention of AIS_XXXXXX.txt with increment from 000001 to 999999. Entry in the log file is vessel’s GPS sentence in IEC61162 format.

When memory is full, SD LED light indicator will turn steady green to remind user to replace the SD card. No further data logging will take place before new saving capacity is available or replaced with an empty SD card.

Removing SD card from the transponder stops data logging immediately, and the SD LED will turn off. Make sure the device’s power is off before inserting SD card.

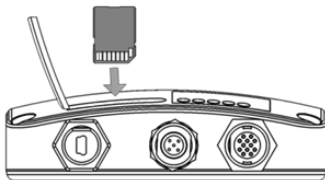

Figure 19 **Inserting SD memory card**

4.4 Wi-Fi Configuration (CAMINO-108W only)

Installation of Wi-Fi antenna is straight forward. Screw on the antenna firmly and then raise up the antenna.

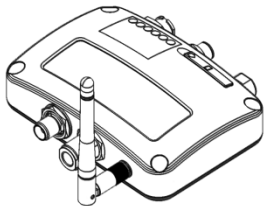

Figure 20 Transponder with Wi-Fi antenna connected

The information below details the information required for connecting the CAMINO-108W to another device using Wi-Fi.

■ SSID (Service Set Identifier):

The SSID for the CAMINO-108W is AIS-B-NNNN where NNNN is the last 4 digits of the units serial number (printed on the label on the side of the unit)

■ Security Encryption:

- Any device being used to connect to the unit via Wi-Fi should support WPA-PSK with TKIP data encryption
- If requested by your device for an IP address or port number, use the following details

- IP Address 192.168.2.1
- Port 3333

■ **Password:**

The Wi-Fi Network key is **123456789@**

The SSID, security encryption and Network key (password) are non-configurable and pre-set at the factory.

4.5 Built-in Integrity Test (BIIT)

With BIIT (Built in Integrity Test) function, the CAMINO-108 is constantly monitoring and testing the integrity of the AIS transponder. Should an abnormal condition be detected within the device, the Error LED will alert with flashing red light. Abnormal conditions may include situations like the followings:

- Antenna VSWR exceeding the maximum allowed level (Error LED flash)
- MMSI not set (Error LED steady on)
- Background noise level exceeds allowable threshold (-77dBm) (Error LED flash)
- GPS is unable to gain lock (3D fixed) after 30 minutes of losing GPS signal (Error LED flash)
- Low input power (< 8.6 V DC) (Error LED flash)

4.6 AIS Viewer Description

The AIS Viewer is a complementary charting software supplied with your CAMINO-108 transponder purchase. The software installation file and its user manual can be found in the provided CD-ROM.

This powerful tool allows users to display AIS targets either on a basic line map or in an alphanumeric view. It transforms your PC to a user-friendly AIS data logger and can trace other vessels with voyage track. Besides, the software offers various safety features to help users be alerted during their voyage.

Once the program is installed, you can establish a connection to PC either automatically or manually by assigning the COM port and baud rate. Please notice that before trying to connect to PC, you should quit the Configuration Software or vice-versa. The transponder can only establish connection to one software at a time. The AIS CPA/TCPA setting can be configured via AIS Viewer.



Figure 21 AMEC AIS Viewer

4.7 Connecting your Transponder to Macintosh

The instruction how to connect your AMEC AIS Transponder to your Macintosh (MAC) computer and display the received AIS Targets via OpenCPN as an example can be found on the CD attached as well as at <http://www.alltekmarine.com/support.php> in the category "FAQ/Class B: CAMINO-108".

4.8 Introducing AMEC AIS App



The AMEC AIS App is a complimentary App with the purchase of an AMEC AIS CAMINO-108W transponder. The App enables users to monitor the surrounding AIS traffics on your smart phone or tablet PC wirelessly.

The AIS targets are displayed clearly in radar view or in an alphanumeric vessel list format. Data of own vessel can be traced in real time. The App also offers various safety features to help users be alerted during their voyage.

The AMEC AIS App is now available on Apple App Store for iOS devices as well as on Google Play for Android mobile devices.



Legal

Apple, the Apple logo, iPhone, iPad, iTunes, and iOS are trademarks of Apple Inc., registered in the U.S. and other countries. iTunes Store is a service mark of Apple Inc., registered in the U.S. and other countries. App Store are trademarks of Apple Inc.

Google, the Google logo, Android, and Google play are trademarks of Google Inc., registered in the U.S. and other countries.

5 SPECIFICATIONS

5.1 Product Specifications

APPLICABLE STANDARDS	
IEC 62287-1 Ed. 2, 2010	IEC 61108-1 Ed. 1, 2003
IEC 60529 ed.2.1:2006	EN 60945 4th ed.: 2002
IEC 60068-2-52 ed.2:1996	EN 60950-1: 2006
VHF TRANSPONDER	
Frequency Range	156.025 MHz ~ 162.025 MHz
Channel Bandwidth	25 KHz
Modulation	GMSK / FM
Data Rate	9,600 bps
Number of AIS Transmitter	1
Number of AIS Receiver	2 (one time-shared between AIS and DSC)
Number of DSC Receiver	1 (time-shared between AIS and DSC)
AIS Channel 1	CH 87B (161.975 MHz)
AIS Channel 2	CH 88B (162.025 MHz)
Tx Power Output	2 Watt (33 dBm \pm 1.5 dB)
Rx Sensitivity	< -107 dBm @ 20% PER
DSC RECEIVER	
Modulation	1,300 Hz / 2,100 Hz FSK
Data Rate	1,200 bps \pm 30 ppm
Spurious Response Rejection	\geq 70 dB for signal @ -104 dBm; BER \leq 1 %
Blocking	\geq 84 dB for signal @ -104 dBm; BER \leq 1 %

GPS RECEIVER (integrated)	
Receiving Channels	50 channels
Accuracy	IEC 61108-1 compliant
Output Rate	1 Hz
POWER SUPPLY	
Supply Voltage	12V / 24V DC, 2A
Power Consumption (108)	Typically less than 3W average @ 12V DC
Power Consumption (108W)	Typically less than 4W average @ 12V DC
CONNECTION INTERFACE	
GPS Antenna Connector	TNC (Female)
VHF Antenna Connector	SO-239 (Female)
NMEA 2000	Standard connector LEN=1
Silent Mode Setting	Set by the dedicated pins in the 12-pin cable
USB	Mini-B type, waterproof
NMEA 0183 (RS-422)	Support two NMEA 0183 interfaces Baud rate configurable (default 38,400 bps) Separate Tx/Rx baud rate Standard IEC 61162-1 / IEC 61162-2 sentences
Wireless Connection	IEEE 802.11 b/g/n (CAMINO-108W only)
ENVIRONMENTAL	
Operating Conditions	IEC 60945 "protected" category
Operating Temperature	-15°C ~ 55°C
Waterproof	IPX2
PHYSICAL	
Width	128 mm (5.51 inches)
Height	36 mm (1.97 inches)

Depth	88 mm (7.87 inches) (exclude connector)
Weight	250 g
SOFTWARE TOOL	
AMEC AIS Configuration	PC configuration utility
AMEC AIS Viewer	AIS Viewer for PC
ANT-21 GPS Antenna (optional)	
Cable	integral 10m RG-58 cable plus mounting bracket
Supply Voltage	3.3V

SVIB

5.2 Dimensions

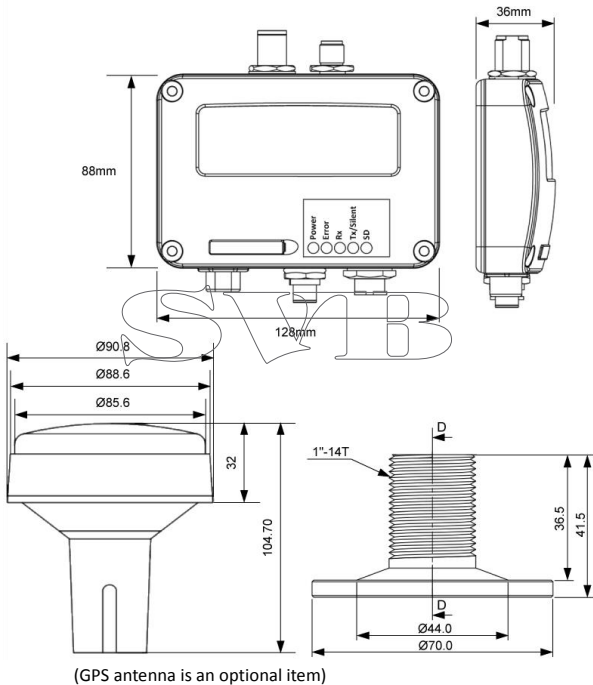

5.3 NMEA 2000 PGN Information

Transmit	
PGN	Description
59392	ISO Acknowledgment
59904	ISO Request
60928	ISO Address Claim
126464	PGN List - Transmit PGN's group function
126996	Product Information
129025	Position Rapid Update
129026	COG SOG Rapid Update
129029	GNSS Position Data
129038	AIS Class A Position Report
129039	AIS Class B Position Report
129040	AIS Class B Extended Position Report
129041	AIS Aids to Navigation (AtoN) Report
129539	GNSS DOPs
129540	GNSS Sats in View
129792	AIS DGNSS Broadcast Binary Message
129793	AIS UTC and Date Report
129794	AIS Class A Static and Voyage Related Data
129795	AIS Addressed Binary Message
129796	AIS Acknowledge
129797	AIS Binary Broadcast Message
129800	AIS UTC/Date Inquiry
129801	AIS Addressed Safety Related Message
129802	AIS Safety Related Broadcast Message

129803	AIS Interrogation
129804	AIS Assignment Mode Command
129805	AIS Data Link Management Message
129806	AIS Class A Position Report
129807	AIS Group Assignment
129808	DSC Call Information
129809	AIS Class B "CS" Static Data Report, Part A
129810	AIS Class B "CS" Static Data Report, Part B
Receive	
PGN	Description
59392	ISO Acknowledgment
59904	ISO Request
60928	ISO Address Claim
127250	Vessel Heading

5.4 Supported NMEA 0183 Sentences

Transmit	
Sentence	Description
GGA	Global Positioning System Fix Data
GSA	GNSS DOP and Active Satellites
GSV	GNSS Satellites In View
GLL	Geographic Position – Latitude/Longitude
RMC	Recommended Minimum Specific GNSS Data
VDO	AIS VHF Data-Link Own-Vessel Report
VDM	AIS VHF Data-link Message
Receive	
Sentence	Description
DTM	Datum Reference
GBS	GNSS Satellite Fault Detection
GSA	GNSS DOP and Active Satellites
HDT	Heading, True
RMC	Recommended Minimum Specific GNSS Data
ROT	Rate Of Turn

6 TROUBLESHOOTING

The transmitting LED (Green color) is not illuminated, why?

- The transmitting interval of a Class B transponder is 3 minutes if the speed of the vessel is less than 2 knots. If the speed exceeds 2 knots, the transmitting interval will be 30 seconds. For each transmission, the channel indicator will flash once quickly. The green light from the Tx indicator could be missed if not observed carefully.
- For AIS transmitting, GPS information from GPS antenna is required. Without GPS information, AIS will not transmit AIS signal. Please check if your GPS antenna is connected and setup correctly.

CAMINO-108 receives AIS signals normally, but no one in the surrounding can see me, why?

- AIS Class B transmission range limitation: an AIS Class B transponder transmitting range of 5-7 miles in perfect conditions. The AIS receiver in the transponder will typically see Class A vessels that are 20-30 miles away or even more in excellent conditions. The major reason is that all AIS Class B transponders transmit at 2 watts vs. the 12.5 watts that Class A transponders typically use. This difference in power impacts on the transmission range of each transponder type. For this reason, it is quite possible that Class A vessel can be seen, but Class B vessel might not be seen.
- VHF antennas interference: if you are using a dedicated AIS/VHF antenna for your transponder, be sure that it is placed at least 6 ft (1.83 m) away from other VHF antennas or vertical metal objects and ideally install the antenna on a different vertical plane from other VHF antennas. In several tests, mounting

two VHF antennas next to another typically reduces the transmitting range to both antennas by 50-70%.

- GPS is not fixed: If your GPS antenna is not connected or setup correctly, your transponder will see other vessels fine, but you will not be sending out your vessel position. All AIS transponders need a good GPS fix before it can send out any type of transmission. The color and state of the LEDs on the transponder indicate if the unit is in transmission mode or not.
- The location of VHF antenna is directly related to AIS transmitting range. The VHF antenna should be installed at mast as high as possible.

The silent mode (Tx off) on CAMINO-108 is not working, why?

- Silent mode can be configured on CAMINO-108 by using the wires at 12-pin connector.

Even though my CAMINO-108 is transmitting, why do some vessels with AIS take a long time to see my vessel name or not see it at all?

- AIS Class B users should keep in mind that Class B transponders do not broadcast position updates as often as Class A commercial transponders. As with Class B transponders, the full static information, such as vessel's names, the transmission is broadcasted every 6 minutes; however, MMSI and dynamic information, such as position, update will only be sent out every 3 minutes if the vessel is moving slower than 2 knots. To add to this, if the receiving party is using non-standard dual channel receiver (a single channel receiver), then in perfect conditions, the receiver will get your full static information every 12 minutes and your MMSI and dynamic information every 6 minutes if you are moored.

No data is being received by chart plotter, why?

- Please check that the power supply is connected correctly at CAMINO-108.
- Please check that the power supply is 12V or 24V with sufficient current capacity (no less than 2A).
- Please make sure that the connections between CAMINO-108 to the chart plotter are correct.

My MMSI is being received by other vessels but my vessel name is not shown on their chart plotter or PC, why?

- Older software and AIS displays may not be fully compatible with Class B transponders. In some of these cases, older equipments might only have Class B vessel show up on their displays with just MMSI number without the vessel name. This is usually due to the receiving device not knowing how to process the Message 24 static data from Class B transponders. Please contact the chart plotter maker and ask for software upgrades (for these older chart plotters) to resolve this issue.

The Red Error LED indication at CAMINO-108 is illuminated, why?

- The unit may not have a valid MMSI. Please check if the AIS transponder is correctly entered with a valid MMSI.
- Please make sure that both VHF and GPS antennas and their cables are working properly and not damaged.

If you still encounter difficulties to set up or operate CAMINO-108 correctly, please email to service@alltekmarine.com for further instructions.

7 ABBREVIATIONS

AIS	Automatic Identification System
COG	Course Over Ground
CPA	Distance to Closest Point of Approach
CSTDMA	Carrier-Sense Time Division Multiple Access
DSC	Digital Selective Calling
ECS	Electronic Chart System
ETA	Estimated Time of Arrival
GPS	Global Positioning System
IMO	International Maritime Organization
MMSI	Maritime Mobile Service Identity
SOG	Speed Over Ground
TCPA	Time to Closest Point of Approach
TDMA	Time Division Multiple Access
UTC	Coordinated Universal Time
VHF	Very High Frequency
VTS	Vessel Traffic Services

8 FCC INTERFERENCE STATEMENT

NOTE: This equipment has been tested and found to comply with the limits for a Class A digital device, pursuant to part 15 of the FCC Rules. These limits are designed to provide reasonable protection against harmful interference when the equipment is operated in a commercial environment. This equipment generates, uses, and can radiate radio frequency energy and, if not installed and used in accordance with the instruction manual, may cause harmful interference to radio communications. Operation of this equipment in a residential area is likely to cause harmful interference in which case the user will be required to correct the interference at his own expense.

This device complies with Part 15 of the FCC Rules. Operation is subject to the following two conditions:

- 1) This device may not cause harmful interference, and
- 2) This device must accept any interference received, including interference that may cause undesired operation.

Any changes or modifications not expressly approved by AMEC for compliance could void of the user's authority to operate the equipment.

9 RF Exposure Warning

WARNING: This device generates and radiates RF electromagnetic energy and must be installed and operated according to the instructions contained in this manual. Failure to do so may result in product malfunction and/or exposure to potentially harmful levels of radio frequency radiation.

WARNING: Never operate this device unless it is properly connected to a VHF antenna. To maximize performance and minimize human exposure to RF energy, always mount the antenna at least 3m from the device.

The system has a Maximum Permissible Exposure (MPE) radius of 60cm from the antenna. This has been determined assuming the maximum power of the transmitter and using a standard half-wave monopole VHF antenna with a maximum gain of 3dBi and termination impedance of 50 ohms.

When installing the antenna and operating the equipment consider the following:

- The antenna should be mounted at a minimum vertical distance of 5m above the deck in order to meet international safety directives on Maximum Permissible Exposure (MPE). Failure to adhere to these limits could expose persons within the 60cm radius to RF radiation in excess of the recommended MPE limits.
- Higher gain VHF antennas will require a larger MPE radius.
- Do not operate the unit when anyone is within the MPE radius of the antenna.
- The antenna should not be co-located or operated in conjunction with any other transmitting antenna.

DECLARATION OF CONFORMITY

Hereby, Alltek Marine Electronics Corp. (AMEC) declares that this CAMINO-108 is in compliance with the essential requirements and other relevant provisions of Directive 1999/5/EC.

AMEC WORLDWIDE WARRANTY

Limited warranty

Subject to the terms, conditions and limitations set forth in this Worldwide Limited Warranty (hereinafter the “Warranty”), AMEC warrants that its products, when properly installed and used, will be free from defects in material and workmanship for a period of twelve (12) months, from the date of first purchase (the ‘Warranty Period’) For the purposes of this warranty, ‘date of first purchase’ means the date that the product was purchased by the first retail customer, or by the institutional customer, or in the case of a product installed on a new vessel or any other marine related platform by a certified AMEC original equipment manufacturer (a ‘AMEC OEM’), the date that such vessel was purchased by the first retail customer.

AMEC will, at its sole option, repair or replace any defective products or components returned during the Warranty Period in accordance with the terms, conditions and limitations set forth below. Such repairs or replacement will be the sole remedy of the customer under this Warranty.

Standard Warranty Service

To qualify for standard warranty service the product must be returned to a AMEC-certified service agent (i) within the Warranty Period, and (ii) within thirty (30) days of the alleged product failure. Any products returned must be securely packaged and sent

pre-paid and insured to AMEC or to a AMEC-certified service agent. All products returned must be accompanied by a copy of the original sales receipt to be eligible for standard warranty service.

Other conditions

This Warranty is fully transferable provided that you furnish the original proof of purchase to the AMEC -certified service agent. This Warranty is void if the seal label is removed or defaced.

THE LIABILITY OF AMEC TO A CUSTOMER UNDER THIS WARRANTY, WHETHER FOR BREACH OF CONTRACT, TORT, BREACH OF STATUTORY DUTY OR OTHERWISE SHALL IN NO EVENT EXCEED AN AMOUNT EQUAL TO THE TOTAL PURCHASE PRICE OF THE PRODUCT GIVING RISE TO SUCH LIABILITY AND IN NO EVENT SHALL AMEC BE LIABLE FOR SPECIAL, INCIDENTAL, CONSEQUENTIAL OR INDIRECT DAMAGES OR LOSS OF GOODWILL, REPUTATION, LOSS OF OPPORTUNITY OR INFORMATION, DATA, SOFTWARE OR APPLICATIONS.

In the event that any term or provision contained in this Warranty is found to be invalid, illegal or unenforceable by a court of competent jurisdiction, then such provision shall be deemed modified to the extent necessary to make such provision enforceable by such court, taking into account the intent of the parties.

All AMEC products sold or provided hereunder are merely aids to navigation. It is the responsibility of the user to exercise discretion and proper navigational skill independent of any AMEC product.

Appendix: How to Determine Serial Port

If your PC/laptop does not have an available serial port, you may use an RS232-to-USB adapter. To find out the proper serial port for connection, use the following instructions.

Windows 7 or VISTA version:

Click on "Start" → Select "Control Panel" → Select "Device Manager" → Click Port (COM&LPT)

Windows 8 and 8.1:

Click (W)* + I and then click on Control Panel → Select "Device Manager" → Click Port (COM&LPT)

Windows 10

 + S → type Device Manager in the search box, and select Device Manager from the list of results. Expand the Ports (COM & LPT) and port number are presented with numerical number within a parenthesis in the following format (COMXX).

* means Windows button

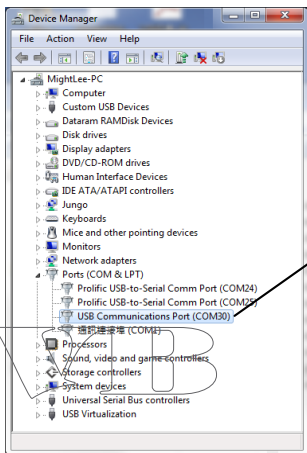
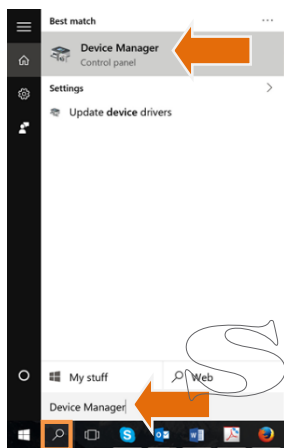



Alltek Marine Electronics Corporation

14F-2, No. 237, Sec. 1, Datong Rd.,
Xizhi Dist., New Taipei City, 22161, Taiwan

Tel: +886 2 8691 8568

Fax: +886 2 8691 9569

Email: service@alltekmarine.com

Website: www.alltekmarine.com