

SIMRAD

GO7

Installation Manual

ENGLISH



Preface

Disclaimer

As Navico is continuously improving this product, we retain the right to make changes to the product at any time which may not be reflected in this version of the manual. Please contact your nearest distributor if you require any further assistance.

It is the owner's sole responsibility to install and use the equipment in a manner that will not cause accidents, personal injury or property damage. The user of this product is solely responsible for observing safe boating practices.

NAVICO HOLDING AS AND ITS SUBSIDIARIES, BRANCHES AND AFFILIATES DISCLAIM ALL LIABILITY FOR ANY USE OF THIS PRODUCT IN A WAY THAT MAY CAUSE ACCIDENTS, DAMAGE OR THAT MAY VIOLATE THE LAW.

Governing Language: This statement, any instruction manuals, user guides and other information relating to the product (Documentation) may be translated to, or has been translated from, another language (Translation). In the event of any conflict between any Translation of the Documentation, the English language version of the Documentation will be the official version of the Documentation.

This manual represents the product as at the time of printing. Navico Holding AS and its subsidiaries, branches and affiliates reserve the right to make changes to specifications without notice.

Copyright

Copyright © 2015 Navico Holding AS.

Warranty

The warranty card is supplied as a separate document.

In case of any queries, refer to the brand website of your unit or system: simrad-yachting.com.

Regulatory statements

This equipment is intended for use in international waters as well as coastal sea areas administered by countries of the E.U. and E.E.A.

The G07 complies with:

- CE under R&TTE directive 1999/5/EC
- The requirements of level 2 devices of the Radiocommunications (Electromagnetic Compatibility) standard 2008

The relevant Declaration of conformity is available in the GO7 section on the following website: simrad-yachting.com.

Warning

The user is cautioned that any changes or modifications not expressly approved by the party responsible for compliance could void the user's authority to operate the equipment.

This equipment generates, uses and can radiate radio frequency energy and, if not installed and used in accordance with the instructions, may cause harmful interference to radio communications. However, there is no guarantee that the interference will not occur in a particular installation. If this equipment does cause harmful interference to radio or television reception, which can be determined by turning the equipment off and on, the user is encouraged to try to correct the interference by one or more of the following measures:

- Reorient or relocate the receiving antenna
- Increase the separation between the equipment and receiver
- Connect the equipment into an outlet on a circuit different from that of the receiver
- Consult the dealer or an experienced technician for help

Trademarks

Lowrance® and Navico® are registered trademarks of Navico.

Fishing Hot Spots® is a registered trademark of Fishing Hot Spots Inc. Copyright© 2012 Fishing Hot Spots.

Navionics® is a registered trademark of Navionics, Inc.

NMEA 2000® is a registered trademark of the National Marine Electronics Association.

SiriusXM® is a registered trademark of Sirius XM Radio Inc.

FUSION-Link™ Marine Entertainment Standard™ is a registered trademark of FUSION Electronics Ltd.

The terms HDMI and HDMI High-Definition Multimedia Interface, and the HDMI Logo are trademarks or registered trademarks of HDMI Licensing LLC in the United States and other countries.

SD™ and microSD™ are trademarks or registered trademarks of SD-3C, LLC in the United States, other countries or both.

Wi-Fi® is a registered trademark of the Wi-Fi Alliance®.

Additional mapping data: Copyright© 2012 NSI, Inc.: Copyright© 2012 by Richardson's Maptech.

Navico product references

This manual refers to the following Navico products:

- Broadband Sounder™ (Broadband Sounder)
- DownScan Imaging™ (DownScan)
- DownScan Overlay™ (Overlay)
- GoFree™ (GoFree)
- SonicHub® (SonicHub)

The Software version

The software version currently on this unit can be found in the About dialog. The About dialog is available in the System Settings. For information about upgrading your software, refer to the Operator Manual.

About this manual

This manual is a reference guide for installing the GO7.

The manual does not cover basic background information about how equipment such as sonar, and AIS work. Such information is available from our web site: simrad-yachting.com

Important text that requires special attention from the reader is emphasized as follows:

→ **Note:** Used to draw the reader's attention to a comment or some important information.

⚠ Warning: Used when it is necessary to warn personnel that they should proceed carefully to prevent risk of injury and/or damage to equipment/personnel.

Manual version

This manual is written for the software version 1.0. The manual is continuously updated to match new software releases. The latest available manual version can be downloaded from simrad-yachting.com.

Contents

- 9 Check the contents**

- 10 GO7 Overview**
 - 10 Front controls
 - 11 Rear connections and Card reader

- 12 Installation**
 - 12 Mounting location
 - 13 Bracket mounting
 - 14 Panel mounting
 - 14 Flush mounting
 - 14 Transducer installation

- 15 Wiring**
 - 15 Guidelines
 - 15 Power Connection
 - 16 Power control connection
 - 17 External alarm
 - 18 Connecting control devices
 - 18 NMEA 2000 – connection to backbone
 - 21 CZone connection to NMEA 2000
 - 21 Transducer connection

- 22 Software Setup**
 - 22 First time startup
 - 22 Time and Date
 - 22 Source selection
 - 24 Autopilot setup
 - 35 Fuel setup
 - 38 CZone setup
 - 40 Wifi setup
 - 43 Software updates and data backup
 - 45 NMEA 2000 setup

47 Accessories

48 Supported data

48 NMEA 2000 compliant PGN List

53 Specifications

54 Dimensional drawings

1

Check the contents

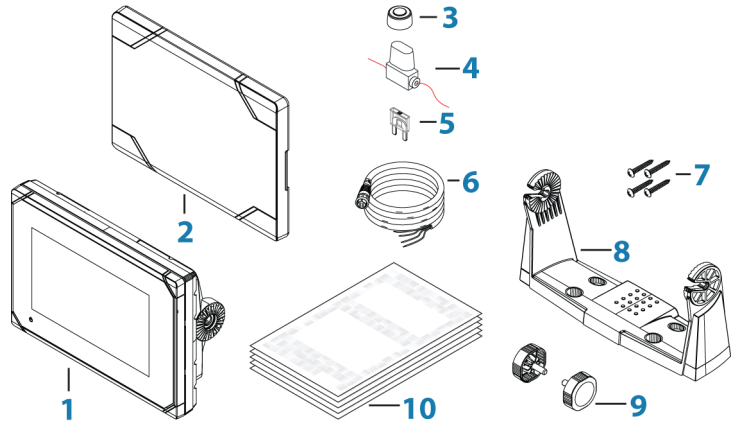

- 1 GO7
- 2 Sun cover
- 3 Caps (2x, on NMEA 2000 and Sonar connectors)
- 4 Fuse holder (ATC blade)
- 5 Fuse (3 amp)
- 6 Power cable
- 7 Screw Fasteners (4 x #10 x 3/4 PN HD SS screws)
- 8 Mounting Bracket
- 9 Bracket knobs (2x)
- 10 Documentation pack (Getting Started manual, Installation manual, and Warranty card)

2

GO7 Overview

Front controls

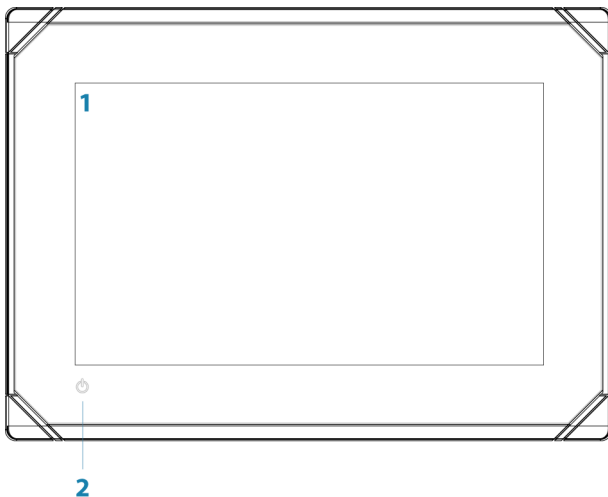

1 Touch screen

2 Power button

Press and hold to turn the unit ON/OFF.
Press once to display the System Controls dialog.

Rear connections and Card reader

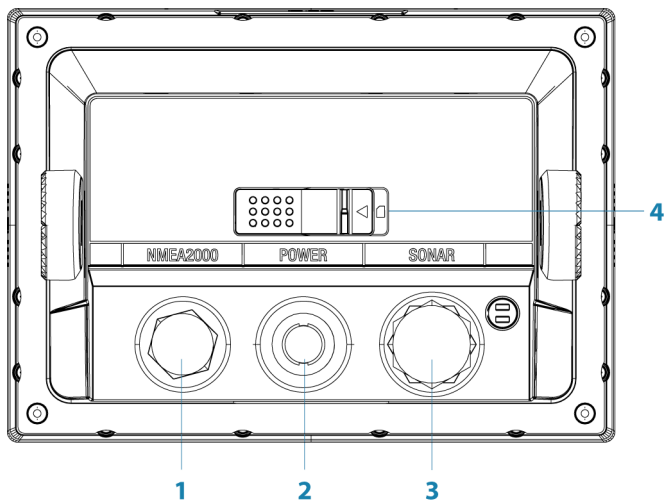

- 1 **NMEA 2000** - data input / output
- 2 **Power** - 12 V supply input
- 3 **Sonar** - CHIRP, Broadband Sounder, and DownScan Imaging
- 4 **Card reader**

Card reader

Used for attaching a microSD memory card. The memory card can be used for detailed chart data, software updates, transfer of user data, and system backup.

The card reader door is opened by pulling the rubber cover open. The card reader door should always be securely shut immediately after inserting or removing a card, in order to prevent possible water ingress.

3

Installation

Mounting location

Choose the mounting locations carefully before you drill or cut. The GO7 should be mounted so that the operator can easily use the controls and clearly see the screen. Be sure to leave a direct path for all of the cables. The GO7 has a high-contrast screen, and is viewable in direct sunlight, but for best results install the unit out of direct sunlight. The chosen location should have minimal glare from windows or bright objects.

Ensure that any holes cut are in a safe position and will not weaken the boat's structure. If in doubt, consult a qualified boat builder, or marine electronics installer.

Before cutting a hole in a panel, make sure that there are no hidden electrical wires or other parts behind the panel.

Check that it is possible to route cables to the intended mounting location.

Leave sufficient clearance to connect all relevant cables.

Do not mount any part where it can be used as a hand hold, where it might be submerged, or where it will interfere with the operation, launching, or retrieving of the boat.

The mounting location may affect the internal GPS receiver. Test the unit in its intended location to ensure satisfactory reception. An external GPS source can be added to overcome poor reception areas.

Choose an area where the unit will not be subjected to excessive vibration, or heat.

Good ventilation is required.

⚠ Warning: Inadequate ventilation may cause the unit to overheat. The GO7 is designed to operate in temperatures from -15°C to $+55^{\circ}\text{C}$ ($+5^{\circ}\text{F}$ to $+131^{\circ}\text{F}$).

For overall width and height requirements, refer to "*Dimensional drawings*" on page 54.

Choose a location that will not expose the unit to conditions that exceed the IP rating - refer to "*Specifications*" on page 53.

▲ **Warning:** When installing, ensure appropriate safety equipment is used. For example, ear muffs, protective glasses, gloves and a dust mask. Power tools may exceed safe noise levels, and can cast off dangerous projectiles. The dust from many materials commonly used in boat construction may cause irritation or damage to eyes, skin, and lungs.

Bracket mounting

1. Place the bracket in the desired mounting location.
 - **Note:** Ensure that the chosen location has enough height to accommodate the unit fitted in the bracket, and allows tilting of the unit. Also adequate space is required on both sides to allow tightening and loosening of the knobs.
2. Mark the screw locations using the bracket as a template, and drill pilot holes.
 - **Note:** Use fasteners suited to the mounting surface material. If the material is too thin for self-tappers, reinforce it, or mount the bracket with machine screws and large washers. Use only 304 or 316 stainless steel fasteners.
3. Screw down the bracket.
4. Mount the unit to the bracket using the knobs. Hand tighten only. The ratchet teeth in the bracket and unit case ensure a positive grip and prevent the unit from changing from the desired angle.

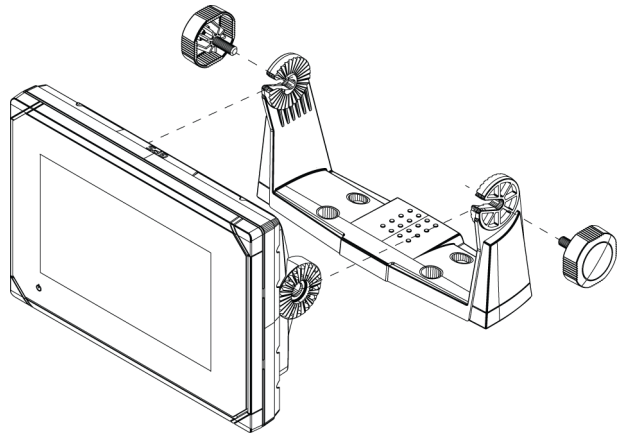

Panel mounting

An optional kit is available for panel mounting. The kit includes a Panel mounting template.

Flush mounting

An optional kit is available for flush mounting. The kit includes a mounting guide.

Transducer installation

For transducer installation information, refer to separate installation instructions included with the transducer.

4

Wiring

Guidelines

Don't do this:	Do this:
Don't make sharp bends in the cables.	Do make drip and service loops.
Don't run cables in a way that allows water to flow down into the connectors.	Do cable-tie all cables to keep them secure.
Don't route the data cables in areas adjacent to radar, transmitter, or large current carrying cables.	Do solder/crimp and insulate all wiring connections, if extending or shortening power or NMEA 2000 cables.
	Do leave room adjacent to connectors to ease plugging and unplugging of cables.

⚠ Warning: Before starting the installation, be sure to turn electrical power off. If power is left on or turned on during the installation, fire, electrical shock, or other serious injury may occur. Be sure that the voltage of the power supply is compatible with the GO7.

⚠ Warning: The positive supply wire (red) should always be connected to (+) DC with the supplied fuse or a circuit breaker (closest available to fuse rating).

Power Connection

The GO7 is powered by 12 V DC. It is protected against reverse polarity, under voltage, and over voltage (for a limited duration).

The supplied power cable has four cores used for:

- Power into the system (Red and Black wires).

- Controlling power state of the unit (Yellow wire).
- Connecting to an external alarm (Blue wire).

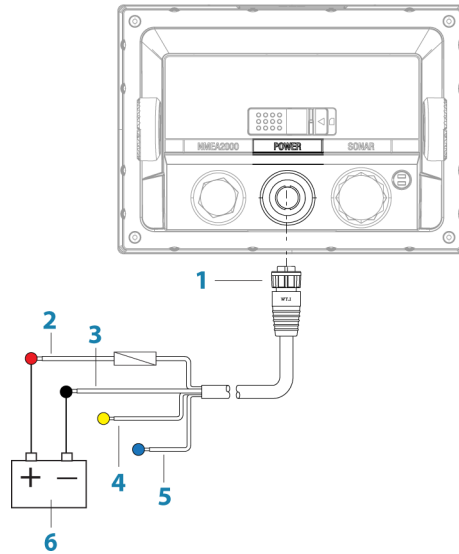

- 1 Power cable connector
- 2 12 V positive wire (red) shown with fuse holder fitted
- 3 12 V negative wire (black)
- 4 Power control wire (yellow)
- 5 Alarm wire (blue)
- 6 Vessel's 12 V DC supply

Connect Red to (+) DC using a 3 amp fuse.

Connect Black to (-) DC.

The unit can be powered on and off using the power button on the front of the case.

Power control connection

The yellow Power Control wire on the GO7 power cable is an input that will turn on the unit when power is applied.

Power Control unconnected

Device will turn on and off when the power button on the front of the unit is pressed. Leave the yellow Power Control wire disconnected and tape or heat-shrink the end to prevent shorting.

Power Control to supply positive (auto on)

Device will turn on immediately when power is applied. Common the yellow wire with the red wire after the fuse.

- **Note:** The unit cannot be powered down by power button, but can be put in to standby mode. (The screen backlight also turns off.)

Power Control to ignition

Device will turn on once ignition is turned on to start engines. Connect the yellow wire to the accessories output of the engine key switch.

- **Note:** Engine start batteries and house batteries should have a common ground connection.

External alarm

Blue wire on power cable:

An external alarm can be connected to the GO7. The external alarm can be a small piezo buzzer connected directly, or a horn siren connected through a relay.

Alarms are configured globally in the system. That is, they can be configured on any one networked multifunction device or Triton instrument, and be seen, heard, and acknowledged from all devices. Individual devices can also be configured to not sound their internal buzzer, but still display the alarm information. For information about configuring alarms, refer to the Alarms section in the Operator Manual.

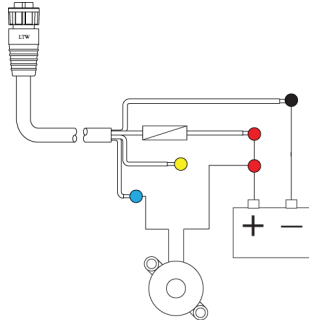

For sirens that draw more than 1 Amp, use a relay.

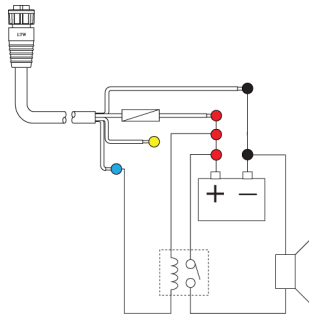

Connecting control devices

The GO7 can be controlled with an OP40 keypad.

→ **Note:** An OP40 is required for Autopilot setup.

NMEA 2000 – connection to backbone

Device connection

The GO7 is equipped with an NMEA 2000 data port, which allows the receiving and sharing of a multitude of data from various sources.

Essential network information

The standardized physical cables/connectors for NMEA 2000 are Micro-C and Mini-C, directly derived from the automation industries 'DeviceNET' - 'Micro-C' being the more commonly used size.

- While most Navico products use Micro-C cabling and connectors, some products still use proprietary SimNet connectors, which are easily made compatible with adaptor cables.
- A network consists of a linear backbone from which drop-cables connect to NMEA 2000 compliant devices.
- A single drop cable has a maximum length of 6 m (20 ft). The total length of all drop cables combined should not exceed 78 m (256 ft).
- A NMEA 2000 network, using Micro-C cabling, has a maximum cable length of 100 m (328 ft), between any two points.
- A NMEA 2000 network needs to have a terminator at each end of the backbone. A terminator can be one of the following:
 - A terminator blank plug.
 - A wind transducer (where the mast cable is one end of the backbone).

Planning and installing a network backbone

The Micro-C backbone needs to run between the locations of all products to be installed - typically in a bow to stern layout - and be no further than 6 m from a device to be connected.

Choose from the following components to make up the backbone:

- Micro-C cables: 0.4 m (1.3 ft), 2 m (6,6 ft), 5 m (16.6 ft), and 9 m (29,5 ft) cables.
 - T-connector. Used to connect a drop cable to the backbone.
 - Micro-C power cables. Connected to backbone using a T-connector.
- **Note:** When using a wind sensor, the mast cable should be connected at one end of the backbone, as the sensor is fitted with a termination resistor.
- **Note:** Most NMEA 2000 devices can be connected directly to a SimNet backbone and SimNet devices can be connected to a NMEA 2000 network by using adapter cables.

Power the network

The network requires its own 12 V DC power supply protected by a 5 amp fuse or breaker. For vessels fitted with 24 V systems, use a DC-DC converter to supply 12 V.

Connect power at any location in the backbone for smaller systems.

For larger systems introduce power at central point in the backbone to “balance” the voltage drop of the network.

- **Note:** If joining to an existing NMEA 2000 network that already has its own power supply, do not make another power connection elsewhere in the network, and ensure the existing network is not powered by 24 V DC.
- **Note:** Do not connect the NMEA 2000 power cable to the same terminals as the engine start batteries, autopilot computer, bow thruster or other high current devices.

The following drawing demonstrates a typical small network. The backbone is made up of directly interconnected T-piece joiners and an extension cable, which is terminated at each end.

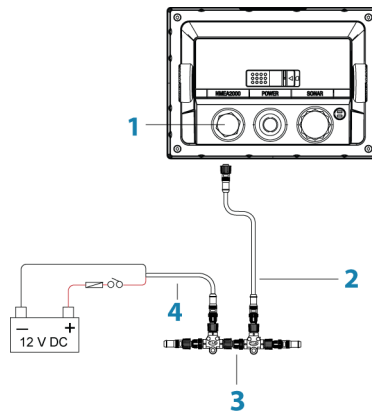

- 1 NMEA 2000 connection
- 2 Drop-cable, should not exceed 6 m (20 ft)
- 3 Backbone
- 4 Power cable

CZone connection to NMEA 2000

When interfacing to C-ZONE network it is recommended to use a BEP Network interface bridge to join the two network backbones together.

The CZONE / NMEA 2000 Network interface bridge isolates the power of the two networks, but allows data to be freely shared between both sides.

The Interface Bridge can also be used for expansion of the NMEA 2000 network, when the maximum node limit (node = any device connected to network) for the network has been reached or the maximum cable length of 150 m will be exceeded. Once an Interface Bridge has been fitted, a further 40 nodes and additional cable length can be added.

The Network Interface is available from your BEP dealer. For more information please refer to the BEP web site www.bepmarine.com.

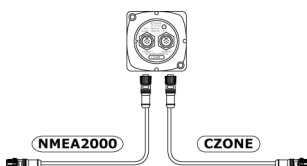

Transducer connection

Navico transducers fitted with a 7 pin blue connector can be plugged directly into the corresponding blue socket labeled **Sonar**.

For connector location, refer to the embossed labeling on the unit or the section "*Overview*" on page 10.

- **Note:** The connector attached to the transducer cable is keyed, and can only be inserted in one orientation. Once inserted, turn locking collar to secure.
- **Note:** The transducer is sold separately. Transducer installation instructions are included with the transducer.

5

Software Setup

The GO7 requires some initial configuration before use, in order to get the most out of the product. The following sections focus on settings that typically do not require change once configured. User preference settings and operation are covered in the Operator Manual. Selecting the Home button opens the Home page, which has three distinct areas. The scrollable left column of icons is the Tools panel and the icons access most settings that require configuration.

First time startup

When the GO7 is started for the first time, or after a factory default, the unit displays a setup wizard. Respond to the setup wizard prompts to select some fundamental setup options.

Time and Date

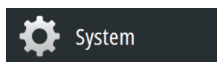

Configure time settings to suit vessel location, along with time and date formats.

Source selection



Data sources provide live data such as GPS position, heading, wind speed, and temperature. The data may originate from modules internal to the device (for example, internal GPS), or external modules connected to the NMEA 2000 network. The internal virtual devices typically include echo, MFD, Navigator, Pilot Controller, and iGPS. When a device is connected to more than one source providing the same data, the user has the flexibility to choose the preferred source. Before commencing with source selection make sure all external devices and the NMEA 2000 bus are connected and are turned on.

Auto Select

The Auto Select option looks for all sources connected to the device. If more than one source is available for each data type, selection is made from an internal priority list. This option is suitable for the majority of installations.

Manual source selection

Manual selection is generally only required where there is more than one source for the same data, and the automatically selected source is not the one desired.

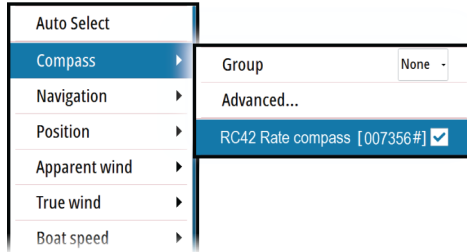

Group source selection

Multifunction displays, autopilot controllers, and instruments have the ability to:

- Use data sources (for example position, wind direction, and so on) that all other products on the network use, or alternatively use a data source independently from other units.
- Globally change all displays over to a different source from any display. (This only includes products set to Group mode.)

→ **Note:** In order to enable group selection, the display must be set to Simrad group.

Devices with the Group set to None can be set to use different sources to those of the rest of the network devices.

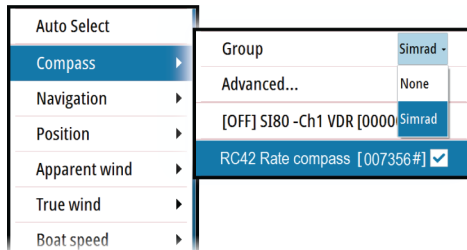

Advanced source selection

This allows the most flexible and precise manual control over which devices provide data. Some data sources, such as those for fuel level, or engine RPM, can only be changed from the Advanced menu. Occasionally Auto Select may not assign the desired source, which may be corrected using the Advanced Source Selection. An example of this is where twin installations with NMEA 2000 compliant engines are not programmed with unique instance numbers. This means that the auto select feature cannot determine which engine is fitted on the port and which is fitted on the starboard side.

→ **Note:** The **Advanced** option is visible in multiple places - the bottom of the **Sources** list, and under each source category (for example, Compass). The latter shows a filtered list that only relates to devices that output data relevant to the category.

Autopilot setup

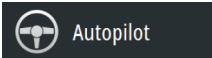

Verifying the autopilot connection

When an AC12N, AC42N, or SG05 is connected to the GO7 system, the GO7 automatically detects the autopilot and an Autopilot menu icon is included in the **Settings** menu.

If no Autopilot icon is available in the menu, establish the connection by running the auto select process.

If the AC12N, AC42N, or SG05 is turned off independently of the unit, the Autopilot menu icon remains available, but only a few of the menu items are available.

Commissioning the autopilot

When the autopilot installation is completed, the commissioning procedures must be performed. Failure in setting up the autopilot correctly may prohibit the autopilot from functioning properly.

The setup of the autopilot computers can be done in full from the GO7 or from a separate autopilot control head.

The following sections describe how you configure the autopilot from the GO7 unit. If you connect the GO7 to an already

commissioned autopilot system, you only have to do an automatic source selection as described above before the autopilot is ready to be used.

→ **Note:** A dedicated physical STBY key is required for commissioning. This can be on the Autopilot control head or on an autopilot remote controller.

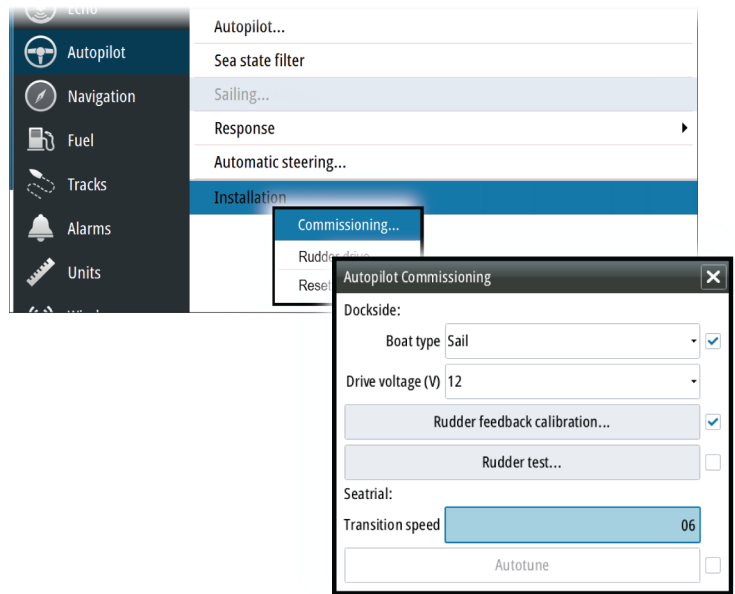

Dockside setup

Initiating the required dockside setup is done from within the Commissioning dialog. Completed procedures are labelled with a tick. When the autopilot computer is delivered from the factory AND ANY TIME AFTER AN AUTOPILOT RESET HAS BEEN PERFORMED, you will have to run a complete setup again.

All steps in all commissioning procedures are clearly described on-screen, and you are guided step by step through the process.

1. Press the **STBY** key to ensure that the autopilot is in standby mode.
2. Select the **Commissioning** option and clear the displayed dialog by pressing the **STDBY** key.
3. Select your boat type.

- The boat type setting is used by the system to select appropriate preset steering parameters. It also affects available autopilot features.
- 4. Perform the rudder calibration.
 - Used if you have a rudder feedback unit installed. This calibration is used to ensure that the physical rudder movement corresponds to the rudder angle displayed on the GO7 unit.
 - The Virtual Feedback option enables your autopilot to steer without a conventional rudder feedback unit. This function is designed for vessels up to 40 ft powered by outboard or stern drives only.
 - The Virtual Feedback option is only available when there is no feedback unit connected at first time turn on, or at turn on after an autopilot reset.
- **Note:** Installing a feedback unit will enhance the performance of the autopilot and provide an accurate rudder angle indicator on the autopilot page. Unless impractical or impossible, a rudder feedback unit should be installed.
- 5. Set the drive voltage. Refer to the drive unit table in the AC12N/AC42N Installation manual or to your drive unit documentation for information.
- 6. Run the rudder test as described in the on-screen instructions.
- **Note:** If the boat uses power assisted steering, it is important that the engine or electric motor used to enable the power assist steering is turned on prior to this test.

⚠ Warning: Stand CLEAR of the wheel and do not attempt to take manual control of the wheel during this test!

- **Note:** When this test is started the autopilot computer issues a series of PORT and STBD rudder commands and automatically verifies correct rudder direction. It detects minimum power to drive the rudder and reduces the rudder speed if it exceeds the maximum preferred speed (8°/sec.) for autopilot operation. The system also detects whether the drive unit is a reversible motor or if a solenoid valve is operated.

Rudder drive setup

The rudder drive setup controls how the autopilot computer controls the steering system.

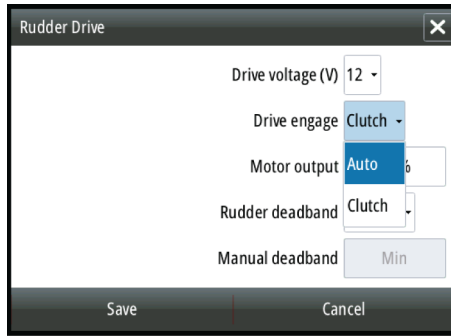

Drive voltage

Voltage specified for your drive unit. The Drive unit voltage setting does not apply when the system operates solenoids on a continuous running pump/steering gear. Hence, the output voltage to the solenoids will be the same as the input voltage.

Refer to the drive unit table in the AC12N/AC42N Installation manual or to your drive unit documentation for information.

⚠ Warning: Selection of improper voltage level for your drive unit may damage both the drive unit and the AC12N/AC42N even if the protection circuits are activated.

Drive engage

Clutch

This is the default setting and it allows you to steer the boat with the helm or wheel when in STBY mode (FU and NFU modes) as well as in all auto steering modes.

Auto

This option is typically used to switch between two rudder speeds on a continuous running pump, used when different rudder speeds are required for automatic and Follow-up/Non-Follow-up steering.

Motor output

Shows the amount of power needed to achieve the correct rudder speed. The reading is obtained from the Rudder test.

The automatically set value may be increased or decreased.

Rudder deadband

This parameter is used to prevent the rudder from hunting. The reading is obtained from the Rudder test which optimizes the deadband to the speed of the boat and the pressure on the rudder. If the auto-setting does not perform properly due to high inertia from the wheel or a loose steering gear, it can be adjusted manually. Find the lowest possible value that will prevent the rudder from continuous hunting. A wide deadband causes inaccurate steering.

→ **Note:** The rudder deadband setting is not available when the autopilot is configured for Virtual Rudder Feedback.

Seatrials

A seatrial can only be performed if the dockside settings are completed and confirmed. The seatrial must always be performed in open waters at a safe distance from other traffic.

→ **Note:** You can switch the autopilot to standby mode and take manual control of the boat at any time during the seatrial by pressing the STBY key on the OP40.

The following seatrial calibration should be done:

- Compass calibration; used to automatically compensate for on-board magnetic interference
- Compass offset adjustment, used to compensate for a fixed offset in the final heading readout
- Wind vane offset is to compensate for a wind vane that is not mounted facing in exactly the same direction as the bow of the vessel (dead ahead)
- Boat speed calibration
- Transition HI/LO speed setting (the speed at which you want to change the set of steering parameters)
- Automatic tuning of the steering parameters
- Setting the seastate filter
- Sailboat Setup menu items

Compass calibration

Before the compass calibration is started, make sure that there is enough open water around the vessel to make a full turn. The calibration should be done in calm sea conditions and with minimal wind to obtain good results. Follow the on-screen instruction, and use about 60–90 seconds to make a full circle. During the calibration, the compass measures the magnitude and direction of the local magnetic field.

- If the local magnetic field is stronger than the earth's magnetic field (the local field is reading more than 100 %), the compass calibration will fail.
 - If the local field is reading more than 30 %, you should look for any interfering magnetic objects and remove them, or you should move the compass to a different location. The (local) field angle guides you to the local interfering magnetic object.
- **Note:** Calibration must be made on the compass that is active for the autopilot. If the compass is not possible to initiate calibration from the device list on the GO7, refer to the compass' own instructions regarding calibration.
- **Note:** In certain areas and at high latitudes the local magnetic interference becomes more significant and heading errors exceeding $\pm 3^\circ$ may have to be accepted.

Compass mounting offset

After compass calibration, the difference (if any) between the compass lubber line and the boat's center line should be compensated for.

1. Find the bearing from the boat position to a visible object. Use a chart or a chart plotter.
 2. Steer the boat so that the center line of the boat is aligned with the bearing line pointing towards the object.
 3. Change the offset parameter so that the bearing to the object and the compass readout becomes equal.
- **Note:** Make sure that both the compass heading and the bearing to the object have the same unit ($^\circ\text{M}$ or $^\circ\text{T}$).

Setting the Transition speed (HI/LO)

This is the speed at which the system automatically changes from LO to HI steering parameters.

On power boats it is recommended that you set a value that represents the speed where the hull begins to plane, or the speed where you change from slow to cruising speed.

On sailboats the transition speed should be set to around 3-4 knots to give the best response in a tack.

A deadband of 2 knots is incorporated to prevent oscillation of HI/LO settings when vessel is travelling at the transition speed.

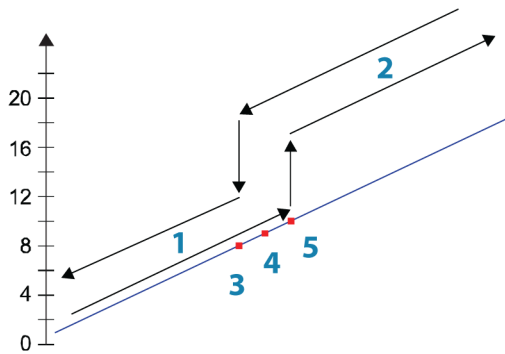

- 1 HI response
- 2 LO response
- 3 Transition to HI parameters with decreasing speed: 8kn
- 4 Transition speed set to 9kn
- 5 Transition to LO parameters with increasing speed: 10kn

Active response parameter set is shown in the autopilot popup and the following abbreviations are used:



- HI-A High response parameters set automatically
- LO-A Low response parameters set automatically
- HI-M High response parameters set manually
- LO-M Low response parameter set manually

Autotuning

The autotune feature runs the boat through several tests and then automatically sets the most important steering parameters. Autotune is not required for the autopilot to function, as it is preset with steering parameters that should steer most boats in the 30-50 foot range. All parameters that are set during autotuning can be manually adjusted.

Seastate filter

The Seastate filter is used to reduce rudder activity and autopilot sensitivity in rough weather.

OFF

Seastate filter is disabled. This is default.

AUTO

Reduces rudder activity and autopilot sensitivity in rough weather by an adaptive process. The AUTO setting is recommended if you want to use the seastate filter.

MANUAL

Linked to the steering response control settings described previously. It may be used to manually find the optimum combination of course keeping and low rudder activity in rough but steady sea conditions.

Setting sailing parameters

- **Note:** Sailing parameter settings are only available if the boat type is set to Sail in the Autopilot Commissioning dialog.

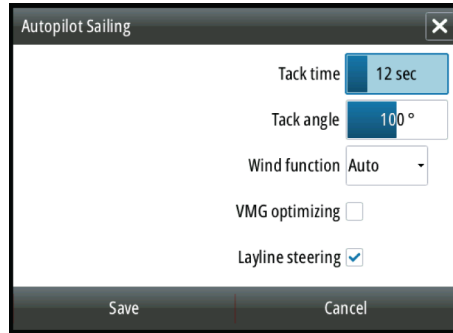

Tack time

When performing a tack in WIND mode, the rate of turn (tack time) can be adjusted. This gives single-handed sailors time to handle the boat and the sails during a tack. A turn performed without shifting wind side, is also made at a controlled turn rate.

Range: 2-50

Change per step: 1

Default: 12

Units: Seconds

Tack angle

This value is used to preset the course change used when tacking in AUTO mode. When you select the left or right arrow key on the Autopilot pop-up, the course changes as much as this value.

Range: 50-150

Change per step: 1

Default: 100

Units: Degrees

Wind function

With wind function set to Auto, the autopilot automatically selects between apparent and true wind steering. Auto is default and recommended for cruising.

When the boat is running or on a broad reach, there is a greater chance it will surf on the waves. This may lead to significant changes in boat speed, and thereby changes in apparent wind angle. True wind steering is therefore used to prevent undesired corrections by the autopilot when heading downwind (or close to), while steering to apparent wind is used when beating or reaching.

Apparent wind steering is preferred when you want to maintain maximum boat speed without continuous trimming of the sails.

VMG optimizing

You can optimize the VMG to wind. When selected, the function will be active for 5–10 minutes after a new wind angle has been set and only when beating.

Layline steering

Layline steering is useful when navigating. Cross Track Error (XTE) from the navigator keeps the boat on the track line. If the XTE from the navigator exceeds 0.15 nm, the autopilot calculates the layline and track towards the waypoint.

Manually adjusting steering parameters

The autotune function in the autopilot is so refined that the majority of boats need no further adjustments of the steering parameters. On some boats however, or in particular sea conditions, fine tuning of the steering parameters may improve the performance of the autopilot.

Transition speed

Refer to "*Setting the Transition speed (HI/LO)*" on page 30.

Rudder

This parameter determines the ratio between commanded rudder and the heading error. The higher rudder value the more rudder is applied. If the value is too small it will take a long time to compensate for a heading error, and the autopilot will fail to keep a steady course. If the value is set too high the overshoot will increase and the steering will be unstable.

Counter rudder

Counter rudder is the amount of rudder used to try to prevent the boat from yawing around the set course. Higher counter rudder settings result in more rudder being applied.

The best way of checking the value of the Counter rudder setting is when making turns.

The following figures illustrate the effects of various Counter Rudder settings:

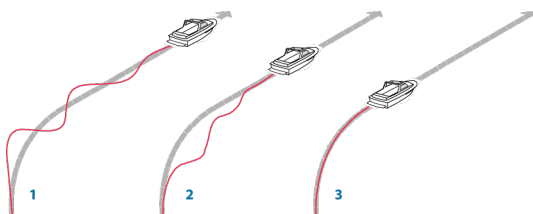

- 1 Counter rudder too low; overshoot response.
- 2 Counter rudder too high; sluggish and creeping response.
- 3 Correct setting of counter rudder; ideal response.

Auto trim

This parameter defines how fast the autopilot shall correspond after having registered a heading error.

The standard value is 40 seconds which should work well on most boats. Rule of thumb: Set to same value (seconds) as the boat's length in feet. On boats operating on VRF, the value should be set to 20 seconds.

Rate limit

Sets the maximum allowed rate of turn.

The value should be kept at 6.0°/second unless there is a need for more rapid response in turns.

Minimum rudder

This parameter filters small rudder commands to prevent high rudder activity.

Some boats may have a tendency to not respond to small rudder commands around the "course keeping" position because of a small

rudder, a rudder deadband, whirls/disturbance of the water-stream passing the rudder, or it is a single nozzle water jet boat.

By increasing the Minimum rudder parameter you may improve the course keeping performance on some boats. However, this will increase the rudder activity.

Minimum wind angle to port and starboard

These parameters should be set identical to the minimum apparent wind angle that will keep the sails from stalling and maintain boat speed. The parameters vary from boat to boat.

The settings are used for the tack-prevent function. They also apply when the autopilot is operating in WindNAV mode.

You can select different minimum wind angles for port and starboard. The difference between port and starboard is taken into account when calculating the Distance To Turn (DTT).

Navigation change limit

This parameter defines the maximum course change that the autopilot is allowed to make when the GO7 is following a route (NAV steering).

If the required course change to the next waypoint in a route is more than the set limit, you are prompted and must acknowledge the course change before the autopilot will turn the vessel.

Fuel setup



The fuel utility monitors a vessel's fuel consumption. This information is totaled to indicate trip and seasonal fuel usage, and is used to calculate fuel economy for display on instrument pages and the data bar.

To use the utility, a Navico Fuel Flow sensor, or a NMEA 2000 engine adaptor cable/gateway with Navico Fuel Data Storage device must be fitted to the vessel. Neither the Navico Fuel Flow sensor, nor the Suzuki engine interface require the use of a separate Fuel Storage device. Refer to the engine manufacturer or dealer for information on whether or not your engine provides a data output, and what adaptor is available to connect to NMEA 2000.

Once the physical connection is made, ensure source selection is completed. Multiple engine installations using Fuel Flow sensors, or Fuel Data Storage devices, require setup of related engine location

in the Device list. For general source selection information, refer to "Source selection" on page 22.

→ **Note:** Multiple engines using a single gateway do not work with the Navico Fuel Storage device.

Vessel setup

The Vessel setup dialog must be used to select the number of engines, the number of tanks and vessel's total fuel capacity across all tanks.

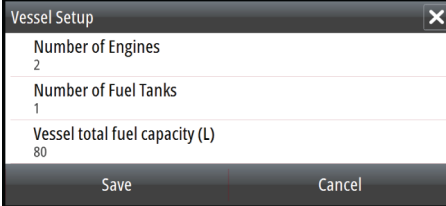

Vessel Setup	
Number of Engines	2
Number of Fuel Tanks	1
Vessel total fuel capacity (L)	80
Save Cancel	

Fuel flow configuration

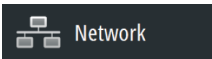

After the number of engines is set, it is required to set which fuel flow sensor is connected to which engine. Under **Device list** on the Network page, view the Device Configuration dialog for each sensor, and set the **Location** to match the engine the device is connected to.

Unconfigure - defaults the device which clears all user settings.

Reset Fuel Flow - restores only the Fuel K-Value setting, if set in Calibrate. Only Navico devices can be reset.

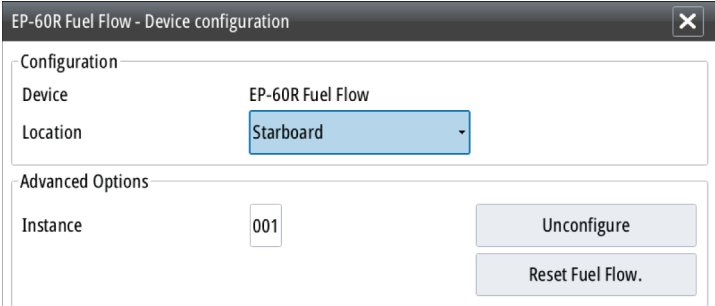

EP-60R Fuel Flow - Device configuration	
Configuration	
Device	EP-60R Fuel Flow
Location	Starboard
Advanced Options	
Instance	001
Unconfigure	
Reset Fuel Flow.	

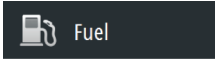

Calibrate

Calibration may be required to accurately match measured flow with actual fuel flow. Access calibration from the **Refuel** dialog. Calibration is only possible on Navico's Fuel Flow sensor.

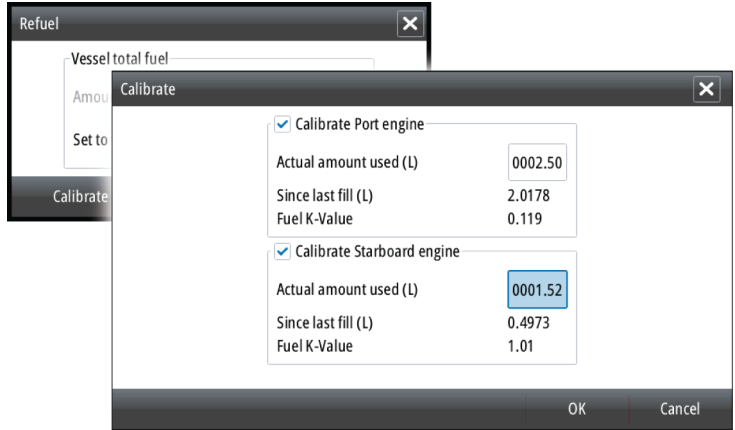

1. Start with a full tank and run the engine as it would normally be operated.
 2. After at least several liters (a few gallons) have been used, the tank should be fully refilled, and the **Set to full** option selected.
 3. Select the **Calibrate** option.
 4. Set the **actual amount used** based on amount of fuel added to the tank.
 5. Select **OK** to save settings. The **Fuel K-Value** should now show a new value.
- **Note:** To calibrate multiple engines repeat the steps above, one engine at a time. Alternatively, run all engines simultaneously, and divide the *Actual amount used* by the number of engines. This assumes reasonably even fuel consumption on all engines.
- **Note:** The **Calibrate** option is only available when **Set to full** is selected, and a Fuel Flow is connected and set up as a source.
- **Note:** A maximum of 8 engines is supported using Fuel Flow sensors.

Fuel Level

With the use of a Navico Fluid Level device connected to a suitable tank level sensor, it is possible to measure the amount of fuel remaining in any equipped tank. The number of tanks must be set in Vessel Setup dialog, initiated from the Fuel setting options page, to allow discrete tank assignment of the Fluid Level devices. Select **Device list** on the Network page, and view the Device Configuration dialog for each sensor, and set the Tank location, Fluid type, and Tank size.

EP-65R Fluid Level - Device configuration

Configuration

Device EP-65R Fluid Level

Tank Center

Fluid type Fuel

Tank size (L) 0704.90

Advanced Options

Instance 000

Unconfigure

For setting up the Instrument bar or a gauge on the Instrument page with Fluid Level device data, refer to the Operator Manual.

- **Note:** A maximum of 5 tanks is supported using Fluid Level devices.
- **Note:** Tank data that is output by a compatible engine gateway can also be displayed, however tank configuration for such a data source is not possible from the GO7.

CZone setup

In order to communicate with the CZone modules connected to the network, the GO7 must be assigned a unique CZone Display Dipswitch setting.

The functionality of the CZone system is determined by the CZone Config File (.zcf), which is stored on all CZone modules and the GO7. The file is created using the CZone Configuration Tool, a

specialized PC application available from BEP Marine Ltd, and associated CZone distributors.

The GO7 system provides a means to load the Config file, as well as apply updates to module firmware, removing the need to take a laptop computer aboard the vessel.

Enabling CZone functionality

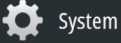

If the CZone device(s) are not automatically detected, it is possible to manually enable CZone.

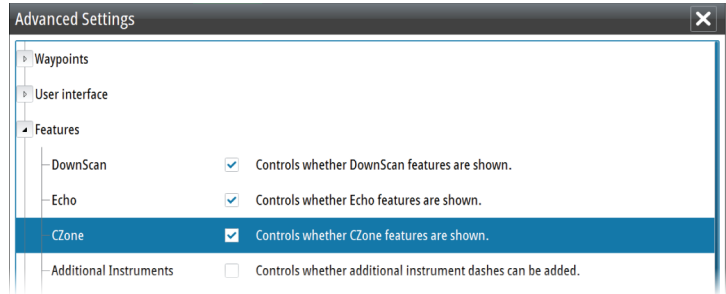

Assigning the dipswitch setting

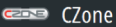

Every product capable of controlling and viewing CZone devices must be assigned a virtual dipswitch setting. This setting is unique for each device. Typically it is set after the configuration file already exists on the CZone system, but it may also be set in advance. To do so, access the CZone menu on the Settings page.

When the configuration is already available on the network, it will immediately commence uploading to the GO7 once the dipswitch is set. Allow this to complete, without interruption.

Setting CZone to display at startup

With this option selected, the CZone control page is shown first, every time the GO7 is powered up.

CZone backlight control

Enabling this causes the GO7 to synchronize its backlight setting with that of any CZone Display Interfaces set up to share backlight settings.

→ **Note:** CZone Config also needs to have the GO7 set as a controller.

Import and backup a configuration file

The files page may be used to import CZone configuration files, or export a copy to a memory card in the card reader. Importing overwrites the existing file on the GO7 and all connected CZone devices.

For further information, see "*Backing up and Importing user data*" on page 43.

Upgrading module firmware

The Files page also allows the loading of NMEA 2000 devices firmware upgrades. For example, CZone firmware updates. For more information, refer to "*NMEA 2000 device upgrades*" on page 45.

Wifi setup

Wireless

The GO7 includes built-in wireless functionality that lets you use a wireless device to remotely view (phone and tablet) and control the system (tablet only). The system is controlled from the wireless device by Apps downloaded from their relevant Application store. Various 3rd party applications can also use the data stream.

Connecting the tablet

1. Navigate to the wifi network connection page on the tablet, and find the GO7, or GoFree Wifi *xxxx* network. If more than one is in range, review the Wireless Devices page on the GO7 to confirm which wireless device is connected to the unit.
2. Select a device on this page to show its network key.
3. Enter the eight character (or longer) Network Key in to the tablet to connect to the network.
4. Open the GoFree application - the GO7 should be automatically detected. The name displayed will be either the default, or that

assigned in the Device Name setting. If the GO7 does not appear, follow the on screen instructions to manually find the device.

5. Select the graphic icon of the GO7. The GO7 displays a prompt similar to the following:

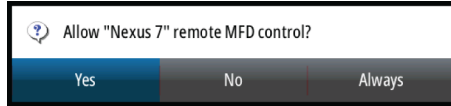

6. Select **Yes** for one-time connection, or **Always** if device is to be remembered for regular connection. This setting can be changed later if required.

→ **Note:** The internal wireless module only supports GoFree connection to itself. Other units connected on the network are not visible.

Remote controllers

When a wireless device is connected, it should appear in the Remote controllers list. Selecting **Always allow** means the device can automatically connect without needing a password each time. This menu also allows disconnection of devices that no longer require access.

Wireless device

This page shows the internal wireless module and its IP and channel number.

Selecting the device provides additional detail. The Network Name and the Network Key can be edited for security, and Channel can be changed if the connection to the unit is compromised due to interference by another RF device transmitting in the same frequency band. Restore defaults returns the unit to factory settings.

Advanced

Tools are available within the GO7 software to assist in fault-finding and setting up the wireless network.

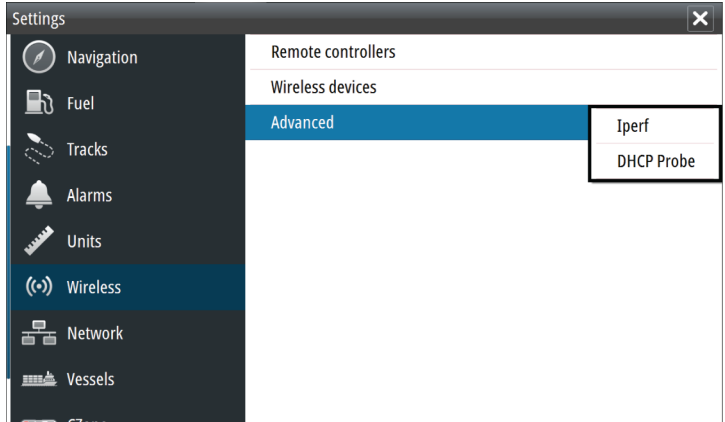

Iperf

Iperf is a commonly used network performance tool. It is provided for testing wireless network performance around the vessel so weak spots or problem areas can be identified. The application must be installed on and run from a tablet device. The GO7 must be running Iperf server before initiating the test from the tablet. On exiting the page, Iperf automatically stops running.

DHCP Probe

The wireless module contains a DHCP server that allocates IP addresses for all the MFDs, and Echosounder in a network. If integrating with other devices, such as a 3G modem or satellite phone, other devices in the network may also be acting as DHCP servers. To make it easy to find all DHCP servers on a network, dhcp_probe may be run from the GO7. Only one DHCP device may be operational on the same network at a time. If a second device is found, turn off its DHCP feature if possible. Refer to the device's own instructions for further assistance.

→ **Note:** Iperf and DHCP Probe are tools provided for diagnostic purposes by users familiar with network terminology and configuration. Navico is not the original

developer of these tools, and cannot provide support related to their use.

Internal Wireless

Select this option to enable or disable the internal wireless module. Disabling wireless when not in use reduces the unit's power consumption.

Software updates and data backup

From time to time we release software updates to our existing products. Updates are created for a variety of reasons; to add or improve features, to add support for new external devices, or to fix software bugs.

Updates can be found on the website: simrad-yachting.com

The GO7 may be used to apply software updates to itself, and to supported NMEA 2000 network devices, with files read off a memory cord inserted in the card reader.

Before initiating an update to the GO7 itself, be sure to back up any potentially valuable user data.

Backing up and Importing user data

There are two files that can be backed up that relate to user changes made to the system:

- Waypoints, Routes, and Tracks database.
- Settings database (includes preferences such as unit settings, custom pages, and CZone configuration files).

Insert a memory card into the unit's card reader as a storage location for backup data.

Waypoints, Routes, and Tracks database backup

You can export all Waypoints, Routes, and Tracks, or export only those contained within a specific region.

If Export Region is selected, the chart page will be displayed, centered on vessel location. Using the touch screen, adjust the red boundary box to outline the area to be exported. The export option offers different file formats to save as:



- **User data file version 5:** Use with current units (NSO evo2, NSS evo2, NSS, NSO, NSE, Zeus, Zeus Touch, HDS Gen2, HDS Gen2 Touch, HDS Gen3). Offers most detail.
- **User data file version 4:** Use with current units (NSO evo2, NSS evo2, NSS, NSO, NSE, Zeus, Zeus Touch, HDS Gen2, HDS Gen2 Touch, HDS Gen3).
- **User data file version 3 (with depth):** Use with legacy GPS chartplotters.
- **User data file version 2 (no depth):** Use with legacy GPS chartplotters.
- **GPX (GPS Exchange, no depth):** Use with some other manufacturers' GPS products, and PC applications.

After you select the file type, select Export and destination memory card. The receiving GPS/PC will typically need to be set to allow import of Waypoints.

Settings database export

Select **Setting database** to export the Settings database, or export CZone configuration (CZone installation dependent). Choose the desired option and select the memory card destination.

Importing a database

Later, if the GO7 has been restored to factory defaults or user data is accidentally deleted, return to the files page, select the backed up file, and then **Import**. View file details for creation date.

Software upgrades

The update file must be loaded to the root directory of the memory card.

The update may be initiated at boot up: insert the memory card into the card reader before turning the unit on, boot the unit, and follow the on-screen instructions.

Alternatively, in the Files menu, locate the update file on the memory card inserted in the card reader and select **Upgrade**, followed by **This Display**. Accept the prompt to reboot the unit, and wait a few moments as the unit restarts. Do not remove the memory card or repower the GO7 until the process is completed (this typically takes no more than a couple of minutes).

Software upgrade of remote device

It is possible to run an update remotely from one unit and apply it to another, provided they are on the NMEA network. This is only possible for units without a card slot.

Remote updating is similar to updating a local unit; select the file on the memory card and select the **Upgrade** option, followed by **Remote Upgrade**. Follow the onscreen options.

NMEA 2000 device upgrades

The update file must be loaded to the root directory of a memory card. inserted in the card reader.

To update NMEA 2000 devices select the **Upgrade** option presented when the file is highlighted. A list should appear displaying any compatible devices the update file applies to. In most cases this will be a single device. Select the device and initiate the upgrade. Do not interrupt the upgrade process.

→ **Note:** If no device is shown, check that the device to be updated has power, and run any outstanding updates for the unit first.

NMEA 2000 setup

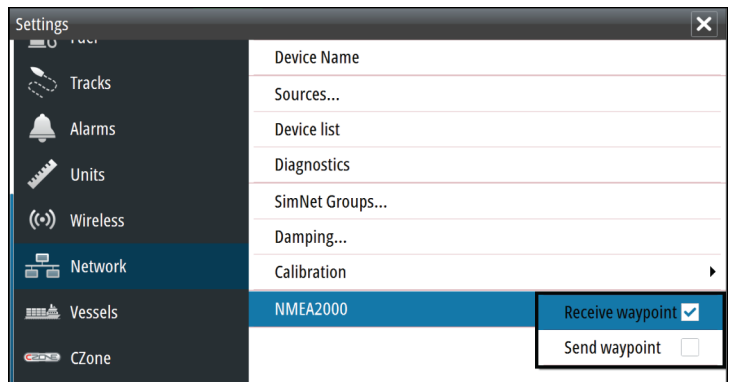

Receive waypoint

Select this option to allow another device capable of creating and exporting waypoints via NMEA 2000 to transfer directly to the GO7.

Send waypoint

Select this option to allow another device to send waypoints via NMEA 2000.

6

Accessories

→ **Note:** The most up-to-date accessories list is available at: simrad-yachting.com

Part number	Description
000-12366-001	GO7 Flush Mount Kit
000-12368-001	GO7 Flush Mount Sun Cover
000-12367-001	GO7 Bracket and Panel Mount Sun Cover
000-12371-001	GO7 Panel Mount Kit
000-12372-001	GO7 U Bracket
000-00128-001	Power Cable

7

Supported data

NMEA 2000 compliant PGN List

NMEA 2000 PGN (receive)

59392	ISO Acknowledgement
59904	ISO Request
60928	ISO Address Claim
61184	Parameter Request/Command
65285	Temperature with Instance
65289	Trim Tab Insect Configuration
65291	Backlight Control
65292	Clear Fluid Level Warnings
65293	LGC-2000 Configuration
65323	Data User Group Request
65325	Reprogram Status
65341	Autopilot Mode
65480	Autopilot Mode
126208	ISO Command Group Function
126992	System Time
126996	Product Info
127237	Heading/Track Control
127245	Rudder
127250	Vessel Heading
127251	Rate of Turn
127257	Attitude
127258	Magnetic Variation
127488	Engine Parameters, Rapid Update
127489	Engine Parameters, Dynamic
127493	Transmission Parameters, Dynamic

127503 AC input status
127504 AC Output Status
127505 Fluid Level
127506 DC Detailed Status
127507 Charger Status
127508 Battery Status
127509 Inverter Status
128259 Speed, Water referenced
128267 Water Depth
128275 Distance Log
129025 Position, Rapid Update
129026 COG & SOG, Rapid Update
129029 GNSS Position Data
129033 Time & Date
129038 AIS Class A Position Report
129039 AIS Class B Position Report
129040 AIS Class B Extended Position Report
129041 AIS aids to Navigation
129283 Cross Track Error
129284 Navigation Data
129539 GNSS DOPs
129540 AIS Class B Extended Position Report
129794 AIS aids to Navigation
129801 Cross Track Error
129283 Cross Track Error
129284 Navigation Data
129539 GNSS DOPs
129540 GNSS Sats in View
129794 AIS Class A Static and Voyage Related Data
129801 AIS Addressed Safety Related Message
129802 AIS Safety Related Broadcast Message
129808 DSC Call Information

129809 AIS Class B "CS" Static Data Report, Part A
129810 AIS Class B "CS" Static Data Report, Part B
130074 Route and WP Service - WP List - WP Name & Position
130306 Wind Data
130310 Environmental Parameters
130311 Environmental Parameters
130312 Temperature
130313 Humidity
130314 Actual Pressure
130576 Small Craft Status
130577 Direction Data
130840 Data User Group Configuration
130842 SimNet DSC Message
130845 Parameter Handle
130850 Event Command
130851 Event Reply
130817 Product Info
130820 Reprogram Status
130831 Suzuki Engine and Storage Device Config
130832 Fuel Used - High Resolution
130834 Engine and Tank Configuration
130835 Set Engine And Tank Configuration
130838 Fluid Level Warn
130839 Pressure Insect Configuration
130840 Data User Group Config
130842 AIS and VHF Message Transport
130843 Sonar Status – Frequency and DSP Voltage
130845 Weather and Fish Prediction and Barometric Pressure History
130850 Evinrude Engine Warnings
130851 Parameter (RC42 Compass and IS12 Wind Calibration and Configuration)

NMEA 2000 PGN (transmit)

61184	Parameter Request/Command
65287	Configure Temperature Insects
65289	Trim Tab Insect Calibration
65290	Paddle Wheel Speed Configuration
65291	Backlight Control
65292	Clear Fluid Level Warnings
65293	LGC-2000 Configuration
65323	Data User Group Request
126208	ISO Command Group Function
126992	System Time
126996	Product Info
127237	Heading/Track Control
127250	Vessel Heading
127258	Magnetic Variation
128259	Speed, Water referenced
128267	Water Depth
128275	Distance Log
129025	Position, Rapid Update
129026	COG & SOG, Rapid Update
129029	GNSS Position Data
129283	Cross Track Error
129284	Navigation Data
129285	Route/Waypoint Data
129539	GNSS DOPs
129540	GNSS Sats in View
130074	Route and WP Service - WP List - WP Name & Position
130306	Wind Data
130310	Environmental Parameters
130311	Environmental Parameters

- 130312 Temperature
- 130577 Direction Data
- 130840 Data User Group Configuration
- 130845 Parameter Handle
- 130850 Event Command
- 130818 Reprogram Data
- 130819 Request Reprogram
- 130828 Set Serial Number
- 130831 Suzuki Engine and Storage Device Config
- 130835 Set Engine And Tank Configuration
- 130836 Fluid Level Insect Configuration
- 130837 Fuel Flow Turbine Configuration
- 130839 Pressure Insect Configuration
- 130845 Weather and Fish Prediction and Barometric Pressure History
- 130850 Evinrude Engine Warnings
- 130851 Parameter (RC42 Compass and IS12 Wind Calibration and Configuration)

8

Specifications

→ **Note:** The most up-to-date specifications list is available at: simrad-yachting.com

Mechanical/Environmental

Casing	PC/ABS
Operating temp	-15°C to +55°C (+5°F to +131°F)
Water ingress	IPX6 and 7
Weight (excluding mounting hardware)	1.310 kg
Screen brightness	1200nits
Screen resolution	480 x 800 (H x W)
Viewing angle in degrees (typical value at contrast ratio = 10)	L/R: 70, top: 50, bottom: 60
Dimensions (overall)	See dimensioned drawings

Electrical

Operating voltage	10 - 17 V DC
Current draw at 13.6V (sonar off, max B/L)	1 A
Low power standby mode	yes
Protection	reverse polarity and temporary over-voltage to 36V
Alarm output current	1 A max
Processor	iMX61 single core
Conformity	CE, C-Tick

Interfaces

NMEA 2000 (compliant)	1 port (Micro-C male)
Sonar	1 port (7 pin blue connector)
microSD card reader	1x microSD

9

Dimensional drawings

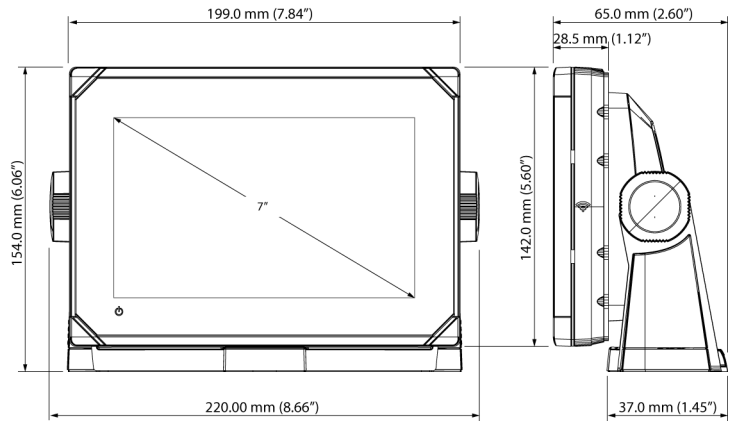



SIMRAD