

# Ray260

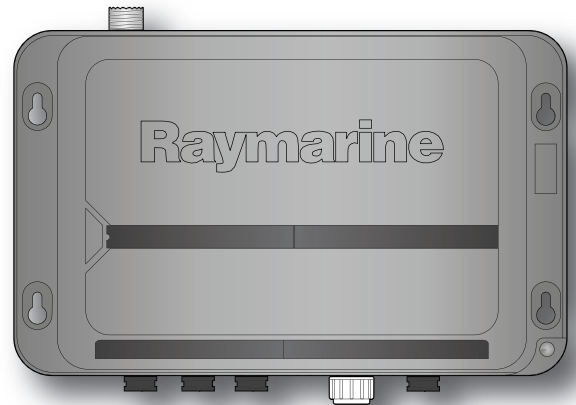

## SVS Installation and operation instructions

### English

Date: 11-2013

Document number: 81343-3-EN

© 2013 Raymarine UK Limited

SWIB

### **Trademark and patents notice**

Autohelm, hsb<sup>2</sup>, RayTech Navigator, Sail Pilot, SeaTalk, SeaTalk<sup>NG</sup>, SeaTalk<sup>HS</sup> and Sportpilot are registered trademarks of Raymarine UK Limited. RayTalk, Seahawk, Smartpilot, Pathfinder and Raymarine are registered trademarks of Raymarine Holdings Limited.

FLIR is a registered trademark of FLIR Systems, Inc. and/or its subsidiaries.

All other trademarks, trade names, or company names referenced herein are used for identification only and are the property of their respective owners.

This product is protected by patents, design patents, patents pending, or design patents pending.

### **Fair Use Statement**

You may print no more than three copies of this manual for your own use. You may not make any further copies or distribute or use the manual in any other way including without limitation exploiting the manual commercially or giving or selling copies to third parties.

### **Software updates**

Check the website [www.raymarine.com](http://www.raymarine.com) for the latest software releases for your product.

### **Product handbooks**

The latest versions of all English and translated handbooks are available to download in PDF format from the website [www.raymarine.com](http://www.raymarine.com). Please check the website to ensure you have the latest handbooks.

**Copyright ©2013 Raymarine UK Ltd. All rights reserved.**

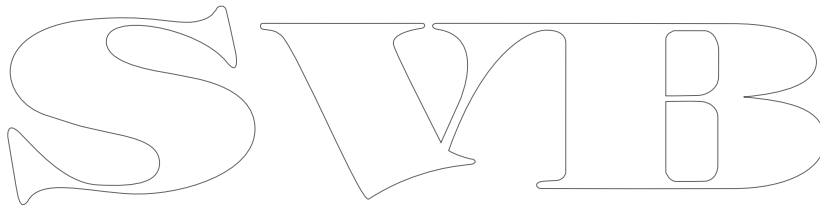
A large, stylized outline logo consisting of the letters 'S', 'W', and 'B' in a decorative, serif font. The 'S' is on the left, 'W' is in the middle, and 'B' is on the right. The letters are interconnected and have a classic, elegant appearance.

SWIB

# Contents

<b>Chapter 1 Important information.....</b>	<b>7</b>	<b>Chapter 7 Digital selective calling (DSC).....</b>	<b>41</b>
Making a distress call.....	7	7.1 Digital Selective Calling (DSC).....	42
Making a Mayday call.....	7	7.2 Distress calls.....	43
Safety notices.....	7	7.3 Urgency calls.....	45
General Information.....	8	7.4 Safety calls.....	46
		7.5 Routine calls.....	46
		7.6 Group calls.....	47
		7.7 Position requests.....	48
		7.8 Position tracking.....	48
		7.9 Test calls.....	49
		7.10 Voice mail.....	49
		7.11 Received call logs.....	50
		7.12 Phonebook.....	50
		7.13 Group list.....	51
		7.14 DSC options.....	51
<b>Chapter 2 Document and product information.....</b>	<b>11</b>	<b>Chapter 8 VHF operations.....</b>	<b>53</b>
2.1 Handbook information.....	12	8.1 Scan mode.....	54
2.2 Product information.....	12	8.2 Watch modes.....	54
		8.3 Priority channels.....	55
		8.4 Favorite channels.....	55
		8.5 Sensitivity.....	56
		8.6 Private channels.....	56
		8.7 Automatic Transmitter Identification System (ATIS) and Marcom-C mode.....	57
		8.8 AIS.....	58
		8.9 Voice recorder.....	58
		8.10 System configuration.....	59
<b>Chapter 3 Planning the installation.....</b>	<b>13</b>	<b>Chapter 9 Hailer, Fog horn, and Intercom.....</b>	<b>61</b>
3.1 System integration.....	14	9.1 Hailer.....	62
3.2 Typical systems.....	15	9.2 Fog horn.....	62
3.3 Installation checklist.....	16	9.3 Handset intercom.....	63
3.4 Schematic diagram.....	16		
3.5 System protocols.....	17	<b>Chapter 10 Maintenance.....</b>	<b>65</b>
3.6 Parts supplied.....	17	10.1 Maintenance.....	66
		10.2 Routine checks.....	66
		10.3 Cleaning.....	67
		10.4 Unit cleaning instructions.....	67
<b>Chapter 4 Cables and connections.....</b>	<b>19</b>	<b>Chapter 11 Troubleshooting.....</b>	<b>69</b>
4.1 General cabling guidance.....	20	11.1 Troubleshooting.....	70
4.2 Connections overview.....	20	11.2 VHF Radio troubleshooting.....	71
4.3 Power connection.....	21		
4.4 NMEA 0183 connection.....	22	<b>Chapter 12 Technical support.....</b>	<b>73</b>
4.5 Loud hailer connection.....	22	12.1 Raymarine customer support.....	74
4.6 Handset connection.....	23		
4.7 Passive speaker connection.....	23	<b>Chapter 13 Technical specification.....</b>	<b>75</b>
4.8 Active speaker connection.....	24	13.1 Technical specification.....	76
4.9 SeaTalk <sup>ng</sup> connection.....	24		
		<b>Chapter 14 Spares and accessories.....</b>	<b>77</b>
		14.1 Ray260 Spares & Accessories.....	78
		14.2 SeaTalk <sup>ng</sup> cables and accessories.....	78
<b>Chapter 5 Location and mounting.....</b>	<b>25</b>	<b>Appendix A NMEA 0183 sentences.....</b>	<b>81</b>
5.1 General location requirements.....	26		
5.2 Base station dimensions.....	27		
5.3 Base station mounting.....	28		
5.4 Speaker mounting.....	28		
5.5 Handset mounting.....	29		
<b>Chapter 6 Getting started.....</b>	<b>31</b>		
6.1 Controls.....	32		
6.2 Switching the radio on.....	32		
6.3 Switching the radio off.....	33		
6.4 Voltage detection.....	33		
6.5 Handset display LCD overview.....	34		
6.6 Entering your MMSI number.....	35		
6.7 Entering your ATIS ID.....	36		
6.8 Selecting NMEA 0183 or SeaTalk <sup>ng</sup> connection.....	37		
6.9 Regional programming.....	37		
6.10 Adjusting the LCD backlight level.....	38		
6.11 Adjusting the LCD contrast.....	38		
6.12 Changing the transmit power.....	39		
6.13 GPS setup.....	39		
6.14 Handset station priority.....	40		

**Appendix B NMEA 2000 sentences ..... 82**  
**Appendix C VHF Channels ..... 83**  
**Appendix D Phonetic alphabet..... 90**  
**Appendix E Prowords ..... 91**

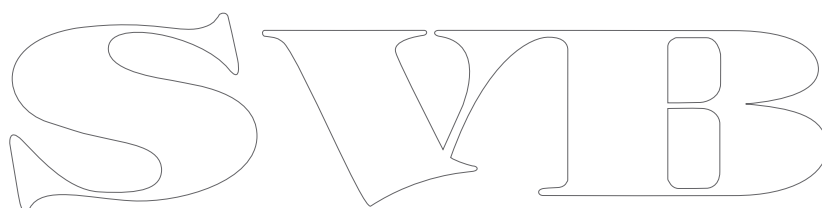

## Making a distress call

In an emergency you can use your product to make an automatic DSC distress call.

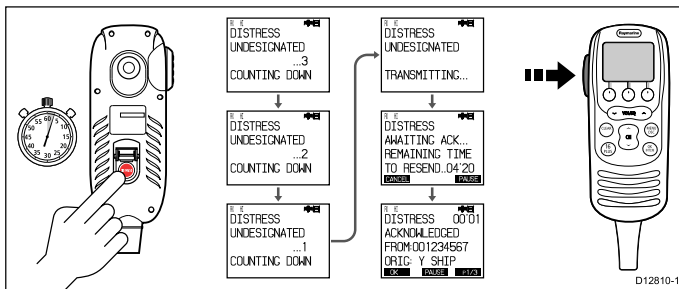

1. Open the spring loaded door on the rear of the handset.
2. Press and hold the **DISTRESS** button for 3 seconds.

Once the DISTRESS button is pressed a 3 second count down will begin, when the count down reaches zero the distress call is transmitted.

3. Wait for an acknowledgement of your distress call.

The distress call is repeated automatically until it is acknowledged.

4. Press and hold the **PTT** button.
5. Slowly and clearly speak the details of the distress:

**MAYDAY, MAYDAY, MAYDAY**

**This is** <state name of vessel 3 times>

**MAYDAY** <state name of vessel 1 time>

**My position is** <state latitude and longitude, or true bearing and distance from a known point.>

**I am** <state nature of distress e.g. sinking, on fire etc.>

**I have** <state number of persons on board and any other information — drifting, flares fired etc.>

**I REQUIRE IMMEDIATE ASSISTANCE**

**OVER**

6. Release the **PTT** button.

## Making a Mayday call

In an emergency you can use your product to make a Mayday call.

1. Press the **16/9** or **16 PLUS** button.
2. Press and hold the **PTT** button.
3. Slowly and clearly speak the details of the distress:

**MAYDAY, MAYDAY, MAYDAY**

**This is** <state name of vessel 3 times>

**MAYDAY** <state name of vessel 1 time>

**My position is** <state latitude and longitude, or true bearing and distance from a known point.>

**I am** <state nature of distress e.g. sinking, on fire etc.>

**I have** <state number of persons on board and any other information — drifting, flares fired etc.>

**I REQUIRE IMMEDIATE ASSISTANCE**

**OVER**

4. Release the **PTT** button.
5. If an acknowledgement is not received then repeat steps 2 to 4 above.

## Certified Installation

Raymarine recommends certified installation by a Raymarine approved installer. A certified installation qualifies for enhanced product warranty benefits. Contact your Raymarine dealer for further details, and refer to the separate warranty document packed with your product.



### Warning: Product installation and operation

This product must be installed and operated in accordance with the instructions provided. Failure to do so could result in personal injury, damage to your vessel and/or poor product performance.



### Warning: Potential ignition source

This product is NOT approved for use in hazardous/flammable atmospheres. Do NOT install in a hazardous/flammable atmosphere (such as in an engine room or near fuel tanks).



### Warning: Positive ground systems

Do not connect this unit to a system which has positive grounding.



### Warning: Switch off power supply

Ensure the vessel's power supply is switched OFF before starting to install this product. Do NOT connect or disconnect equipment with the power switched on, unless instructed in this document.



### Warning: Chassis grounding

Do NOT ground this product using the chassis ground terminal.  
Grounding this product to a vessel's RF ground may cause galvanic corrosion.



### Warning: Antenna isolation

To prevent galvanic corrosion your antenna must be isolated from any vessel metalwork using a suitable insulated e.g. plastic, mounting bracket.



### Warning: FCC Warning (Part 15.21)

Changes or modifications to this equipment not expressly approved in writing by Raymarine Incorporated could violate compliance with FCC rules and void the user's authority to operate the equipment.



### Warning: Maximum Permissible Exposure

Failure to observe these guidelines may expose those within the maximum permissible exposure (MPE) radius to RF radiation absorption that exceeds the FCC MPE limit. It is the radio operator's responsibility to ensure that no one comes within this radius.

For optimal radio performance and minimal human exposure to radio frequency electromagnetic energy, make sure the antenna is:

- connected to the radio before transmitting
- located where it will be away from people
- located at least 1.5 meters (5 feet) from the radio's main unit

### Caution: Power supply protection

When installing this product ensure the power source is adequately protected by means of a suitably-rated fuse or automatic circuit breaker.

### Caution: Perform regular radio checks

Perform regular radio checks when using your vessel, as recommended in radio training and certification schemes and radio equipment rules of use.

### Caution: Ensure proper radio use

Under no circumstances should a DSC distress alert be sent from your radio for test purposes. Such action is a violation of rules of use for radio equipment, and can result in heavy fines.

### Caution: Cleaning

When cleaning this product:

- Do NOT wipe the display screen with a dry cloth, as this could scratch the screen coating.
- Do NOT use abrasive, or acid or ammonia based products.
- Do NOT use a jet wash.

the instructions, may cause harmful interference to radio communications. However, there is no guarantee that interference will not occur in a particular installation. If this equipment does cause harmful interference to radio or television reception, which can be determined by turning the equipment off and on, the user is encouraged to try to correct the interference by one of the following measures:

1. Reorient or relocate the receiving antenna.
2. Increase the separation between the equipment and receiver.
3. Connect the equipment into an outlet on a circuit different from that to which the receiver is connected.
4. Consult the dealer or an experienced radio / TV technician for help.

### Industry Canada

This device complies with Industry Canada License-exempt RSS standard(s).

Operation is subject to the following two conditions:

1. This device may not cause interference; and
2. This device must accept any interference, including interference that may cause undesired operation of the device.

This Class B digital apparatus complies with Canadian ICES-003.

### Licensing

Prior to using this product please check your national requirements for both operators and equipment licensing.

#### Station Licence

FCC station license requirement

An FCC Ship Radio Station License and Call Sign are not required for most recreational vessels travelling in US waters. However, you must obtain a license if your vessel travels to foreign ports.

Ships that use MF/HF single side-band radio, satellite communications, or telegraphy must be licensed by the FCC. You can obtain a Station License by filing FCC Form 605, which is available from the FCC website listed above.

#### Industry Canada

Industry Canada license requirement

You do not need a license to operate this product within sovereign waters of Canada or the US. You will need a license to operate this radio outside of Canada or the US. To obtain Industry Canada licensing information, contact the nearest field or regional office, or write:

Industry Canada Radio Regulatory Branch  
 Attention: DOSP  
 300 Slater Street  
 Ottawa, Ontario  
 Canada, K1A 0C8

#### European licensing requirements

Regulations in some areas require that an Operator's license is obtained before operating a VHF radio. It is your responsibility to determine whether a license is required in your area before operating this equipment.

#### Additional information

The following additional information is required for completing a license application in Canada and the US.

Industry Canada certification number	4069B-RAY260 D
FCC ID	PJ5-RAY260
FCC Type accepted	Parts 2, 15 and 80
Output power	1 watt (low) and 25 watt (high)

## General Information

### Water ingress

Water ingress disclaimer

Although the waterproof rating capacity of this product meets the stated IPX standard (refer to the product's *Technical Specification*), water intrusion and subsequent equipment failure may occur if the product is subjected to commercial high-pressure washing. Raymarine will not warrant products subjected to high-pressure washing.

### Disclaimer

Raymarine does not warrant that this product is error-free or that it is compatible with products manufactured by any person or entity other than Raymarine.

Raymarine is not responsible for damages or injuries caused by your use or inability to use the product, by the interaction of the product with products manufactured by others, or by errors in information utilized by the product supplied by third parties.

### FCC

#### Compliance Statement (Part 15.19)

This device complies with Part 15 of the FCC Rules. Operation is subject to the following two conditions:

1. This device may not cause harmful interference.
2. This device must accept any interference received, including interference that may cause undesired operation.

#### FCC Interference Statement (Part 15.105 (b))

This equipment has been tested and found to comply with the limits for a Class B digital device, pursuant to Part 15 of the FCC Rules.

These limits are designed to provide reasonable protection against harmful interference in a residential installation. This equipment generates, uses, and can radiate radio frequency energy and, if not installed and used in accordance with



Modulation	FM
Frequency range	155.000 MHz to 165.000 MHz

## Maritime Mobile Service Identity (MMSI)

This product is a class “D” Digital Selective Calling (DSC) device. A 9 digit MMSI number is required to operate DSC equipment. In some areas, a radio operator license is required before an MMSI number can be issued.

**Note:** You can request an MMSI number from the same agency that issues radio or ship radio licenses in your area. Once obtained, you can program the MMSI number into your product by following the instruction supplied with the product.

Once obtained, you can program the MMSI number into your product using the instructions provided in this handbook.

If regulations in your area do not permit you to program the MMSI number yourself, your Raymarine dealer can program the number for you.

### Obtaining an MMSI number in the United States

You can request an MMSI number from the FCC when you apply for a Station License. If your vessel does not require a license, you may obtain an MMSI by contacting BoatUS [www.boatus.com](http://www.boatus.com).

### Obtaining an MMSI number in Canada

You can obtain an MMSI number from your nearest Industry Canada Office.

### Obtaining an MMSI number in Europe and rest of world

An MMSI number should be requested from the same agency that issues radio operator licenses in your area.

## Automatic Transmitter Identification System (ATIS)

Your product includes ATIS functionality for use on the inland waterways of contracting governments of the “*Regional Arrangement Concerning the Radiotelephone Service on Inland Waterways*” — also known as the “*Basel Agreement*”.

ATIS adds data at the end of radio transmissions that identifies your station. ATIS operation can be turned on or off as needed via the radio’s menu.

An ATIS number can be obtained from the same agency that issues radio operator licenses in your area.

Your ATIS ID number is derived from your vessel’s call sign. If your call sign is suitable, your authorized Raymarine dealer can assist you in decoding your ATIS ID number, which you can then program into your product using the instructions provided in this handbook.

**Note:** The Basel Agreement includes: Germany, Austria, Belgium, Bulgaria, Croatia, France, Hungary, Luxembourg, Moldova, the Netherlands, Poland, Romania, Russian Federation, the Slovak Republic, Switzerland, the Czech Republic, Ukraine and the Federal Republic of Yugoslavia.

**Note:** When ATIS is enabled, certain programming steps have been implemented to protect the integrity of the Basel agreement, including the blocking of DSC functions when ATIS is active.

## EMC installation guidelines

Raymarine equipment and accessories conform to the appropriate Electromagnetic Compatibility (EMC) regulations, to minimize electromagnetic interference between equipment and minimize the effect such interference could have on the performance of your system

Correct installation is required to ensure that EMC performance is not compromised.

For **optimum** EMC performance we recommend that wherever possible:

- Raymarine equipment and cables connected to it are:
  - At least 1 m (3 ft) from any equipment transmitting or cables carrying radio signals e.g. VHF radios, cables and antennas. In the case of SSB radios, the distance should be increased to 7 ft (2 m).
  - More than 2 m (7 ft) from the path of a radar beam. A radar beam can normally be assumed to spread 20 degrees above and below the radiating element.
- The product is supplied from a separate battery from that used for engine start. This is important to prevent erratic behavior and data loss which can occur if the engine start does not have a separate battery.
- Raymarine specified cables are used.
- Cables are not cut or extended, unless doing so is detailed in the installation manual.

**Note:** Where constraints on the installation prevent any of the above recommendations, always ensure the maximum possible separation between different items of electrical equipment, to provide the best conditions for EMC performance throughout the installation

## Antenna mounting and EME exposure

Ensure that the antenna is connected to the radio before transmission.

Raymarine declares a Maximum Permissible Exposure (MPE) radius of 1.5 metres (4.9 ft) (per OET Bulletin 65) for this system, assuming 25 watts output to an omnidirectional antenna of 3dBi gain or less.

For watercraft with suitable structures, the antenna base must be at least 3.5 metres (11.5 ft) above the main deck to meet the MPE for persons up to 2 metres (6.6 ft) tall. For watercraft without such structures, the antenna must be mounted so that its base is a minimum of 1.5 metres (4.9 ft) vertically from heads of all persons.

The antenna must be isolated from the vessel’s metalwork using an insulated (e.g. plastic) mounting bracket.

## Connections to other equipment

Requirement for ferrites on non-Raymarine cables

If your Raymarine equipment is to be connected to other equipment using a cable not supplied by Raymarine, a suppression ferrite **MUST** always be attached to the cable near the Raymarine unit.

## Declaration of conformity

Raymarine UK Ltd. declares that this product is compliant with the essential requirements of R&TTE directive 1999/5/EC.

The original Declaration of Conformity certificate may be viewed on the relevant product page at [www.raymarine.com](http://www.raymarine.com).

## Product disposal

Dispose of this product in accordance with the WEEE Directive.



The Waste Electrical and Electronic Equipment (WEEE) Directive requires the recycling of waste electrical and electronic equipment. Whilst the WEEE Directive does not apply to some Raymarine products, we support its policy and ask you to be aware of how to dispose of this product.

## Warranty registration

To register your Raymarine product ownership, please visit [www.raymarine.com](http://www.raymarine.com) and register online.

It is important that you register your product to receive full warranty benefits. Your unit package includes a bar code label indicating the serial number of the unit. You will need this serial number when registering your product online. You should retain the label for future reference.

## IMO and SOLAS

The equipment described within this document is intended for use on leisure marine boats and workboats not covered by International Maritime Organization (IMO) and Safety of Life at Sea (SOLAS) Carriage Regulations.

## Technical accuracy

To the best of our knowledge, the information in this document was correct at the time it was produced. However, Raymarine cannot accept liability for any inaccuracies or omissions it may contain. In addition, our policy of continuous product improvement may change specifications without notice. As a result, Raymarine cannot accept liability for any differences between the product and this document. Please check the Raymarine website ([www.raymarine.com](http://www.raymarine.com)) to ensure you have the most up-to-date version(s) of the documentation for your product.

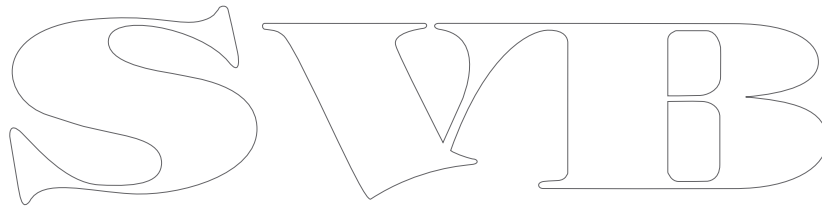
The image shows the letters 'SWIB' in a large, stylized, outlined font. The letters are white with a thin black outline. The 'S' is a simple, rounded shape. The 'W' is composed of two 'V' shapes joined at the top. The 'I' is a simple vertical bar. The 'B' is a simple, rounded shape with a vertical bar in the middle.

## Chapter 2: Document and product information

### Chapter contents

- [2.1 Handbook information on page 12](#)
- [2.2 Product information on page 12](#)

SWIB

## 2.1 Handbook information

This handbook contains important information regarding your DSC VHF Radio.

### Ray260 handbooks

The following handbooks are applicable to your Ray260:

All documents are available to download in pdf format from the Raymarine website [www.raymarine.com](http://www.raymarine.com).

#### Handbooks

Description	Part number
Mounting and getting started	88014
Installation and operation instructions	81343
Ray260 mounting template	87167
Speaker mounting template	87168

### SeaTalk<sup>ng</sup> handbooks

Description	Part number
<b>SeaTalk<sup>ng</sup> reference manual</b> Planning and connection of systems based around the SeaTalk <sup>ng</sup> network.	81300
<b>SeaTalk – SeaTalk<sup>ng</sup> converter handbook</b> Installation and connection of the SeaTalk - SeaTalk <sup>ng</sup> converter.	87121

### User manuals Print Shop

Raymarine provides a Print Shop service, enabling you to purchase a high-quality, professionally-printed manual for your Raymarine product.

Printed manuals are ideal for keeping onboard your vessel, as a useful source of reference whenever you need assistance with your Raymarine product.

Visit <http://www.raymarine.co.uk/view/?id=5175> to order a printed manual, delivered directly to your door.

For further information about the Print Shop, please visit the Print Shop FAQ pages: <http://www.raymarine.co.uk/view/?id=5751>.

#### Note:

- Accepted methods of payment for printed manuals are credit cards and PayPal.
- Printed manuals can be shipped worldwide.
- Further manuals will be added to the Print Shop over the coming months for both new and legacy products.
- Raymarine user manuals are also available to download free-of-charge from the Raymarine website, in the popular PDF format. These PDF files can be viewed on a PC / laptop, tablet, smartphone, or on the latest generation of Raymarine multifunction displays.

## 2.2 Product information

The Ray260 is a Class D Digital Selective Calling (DSC) VHF radio. DSC enables you to make a selective call to a specific radio, and to transmit and receive position information to and from the selected radio. DSC also allows transmission of a distress alert to all radios within range at the touch of a button. Once a DSC request is sent and acknowledged voice communication is carried out on the channel chosen by the caller. The radio can transmit and receive on all available US, Canadian and international and private marine VHF channels.

Your product includes the Ray260 base station, a handset and either a passive or an active speaker (depending on variant). Extra handsets, active and passive speakers can be added to the standard Ray260 providing up to 3 fully functional stations.

With an optional loud hailer connected the radio can also be used as a fog horn or loud public address (PA) system.

The Ray260 is available in the following variants:

Variant	Description	Speaker type	Part number
Ray260	US/Canadian variant	Passive	E70087
Ray260 AIS	US/Canadian variant with built in AIS receiver	Passive	E70088
Ray260E	European variant	Passive	E70089
Ray260E	European variant	Active	E70253
Ray260E AIS	European variant with built in AIS receiver	Passive	E70090

### Passive and active speakers

The product can be supplied with either a passive or an active speaker.

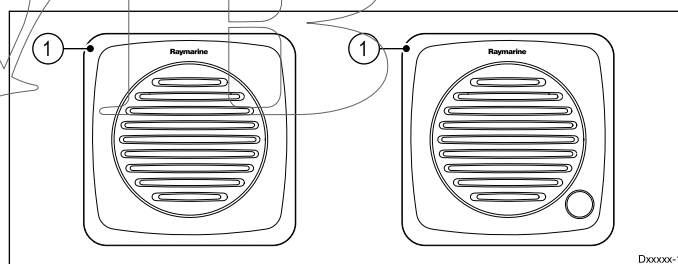

1	Passive speaker (A80198)
2	Active speaker (A80199)

#### Active speakers

Active speakers connect in-line with your handset and include a built-in amplifier and dedicated volume control.

#### Passive speakers

Passive speakers connect to the speaker pigtail on the handset adaptor cable, speaker volume is controlled using the handset volume controls. Passive speakers do not have a built-in amplifier or volume control.

**Note:** You can only connect 1 active speaker or 1 passive speaker per handset station.

# Chapter 3: Planning the installation

## Chapter contents

- [3.1 System integration on page 14](#)
- [3.2 Typical systems on page 15](#)
- [3.3 Installation checklist on page 16](#)
- [3.4 Schematic diagram on page 16](#)
- [3.5 System protocols on page 17](#)
- [3.6 Parts supplied on page 17](#)

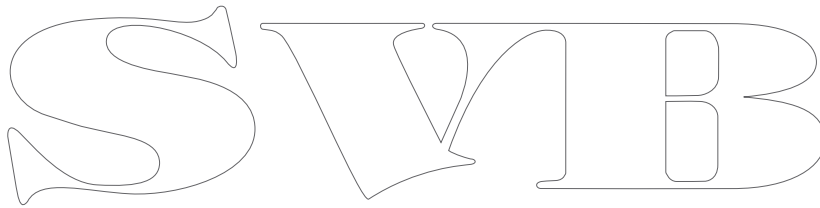

### 3.1 System integration

Your VHF radio can be connected to the following marine electronics devices.

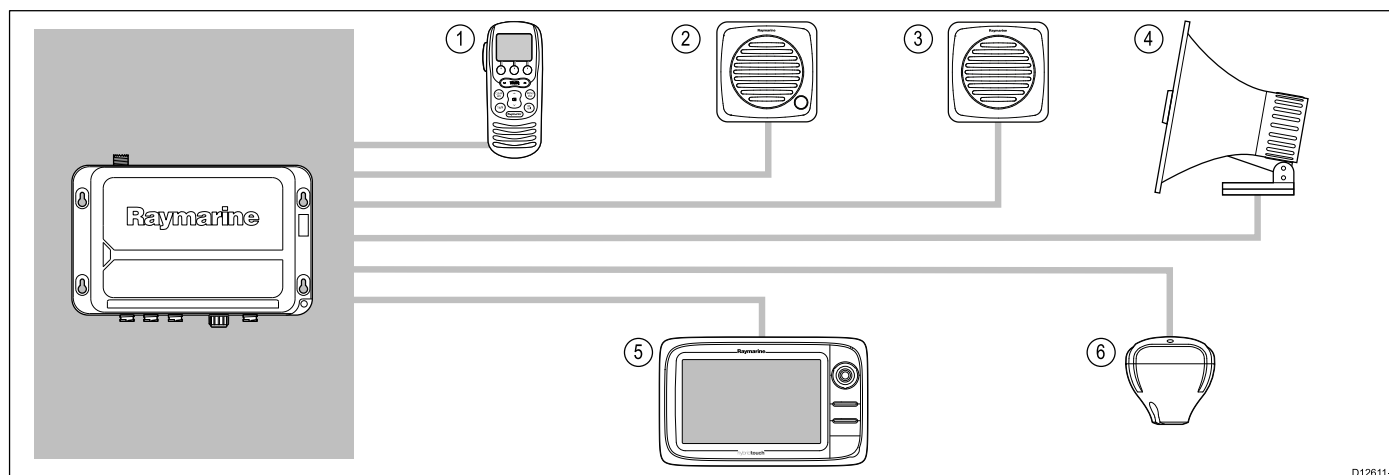

D12611-1

Item	Device type	Maximum quantity	Suitable devices	Connections
1	Ray260 handset	3	Ray260 handset	1 per base station handset connection
2	Active Speaker	3	Ray260 active speaker	1 per handset
3	Passive speaker	3	Ray260 passive speaker	1 per handset
4	Loud hailer	1	<ul style="list-style-type: none"> <li>• 30 Watt Loud hailer</li> <li>• 30 Watt Loud hailer with listen-back</li> </ul>	power/data cable
5	Raymarine multifunction display	6	<p>The Ray260 is compatible with the following Raymarine multifunction displays:</p> <ul style="list-style-type: none"> <li>• a Series</li> <li>• c Series</li> <li>• e Series</li> <li>• gS Series</li> <li>• C-Series Widescreen (NMEA 0183 DSC messages only)</li> <li>• E-Series Widescreen (NMEA 0183 DSC messages only)</li> <li>• G-Series system (NMEA 0183 DSC messages only)</li> </ul>	SeaTalk <sup>ng</sup> or NMEA 0183
6	GPS Receiver	1	<ul style="list-style-type: none"> <li>• RS130</li> <li>• RS125</li> <li>• Raymarine multifunction display equipped with internal GPS</li> </ul>	SeaTalk <sup>ng</sup> or NMEA 0183 with an NMEA 0183 to NMEA 2000 converter.

**Note:** The Ray260 does not support connection to NMEA 0183 and SeaTalk<sup>ng</sup> at the same time.

## 3.2 Typical systems

The Ray260 can be installed as a standalone radio with peripherals or as part of a marine electronics network.

### Standalone DSC VHF radio system

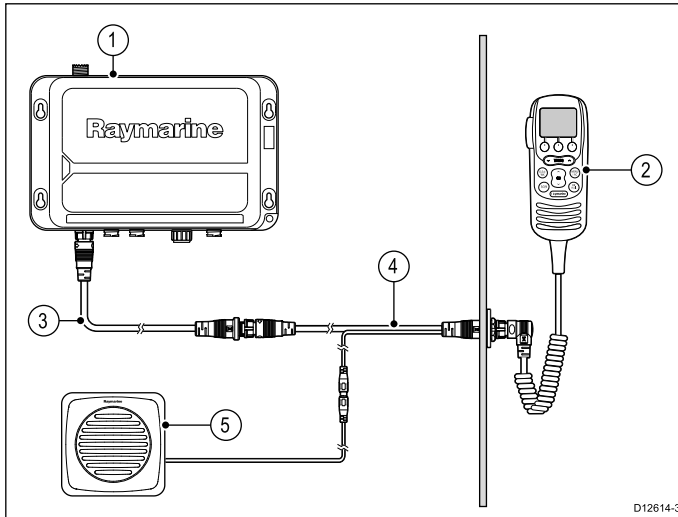

1. Ray260 base station
2. Handset
3. Handset extension cable
4. Handset adaptor cable
5. Passive speaker

SVIB

## Extended system

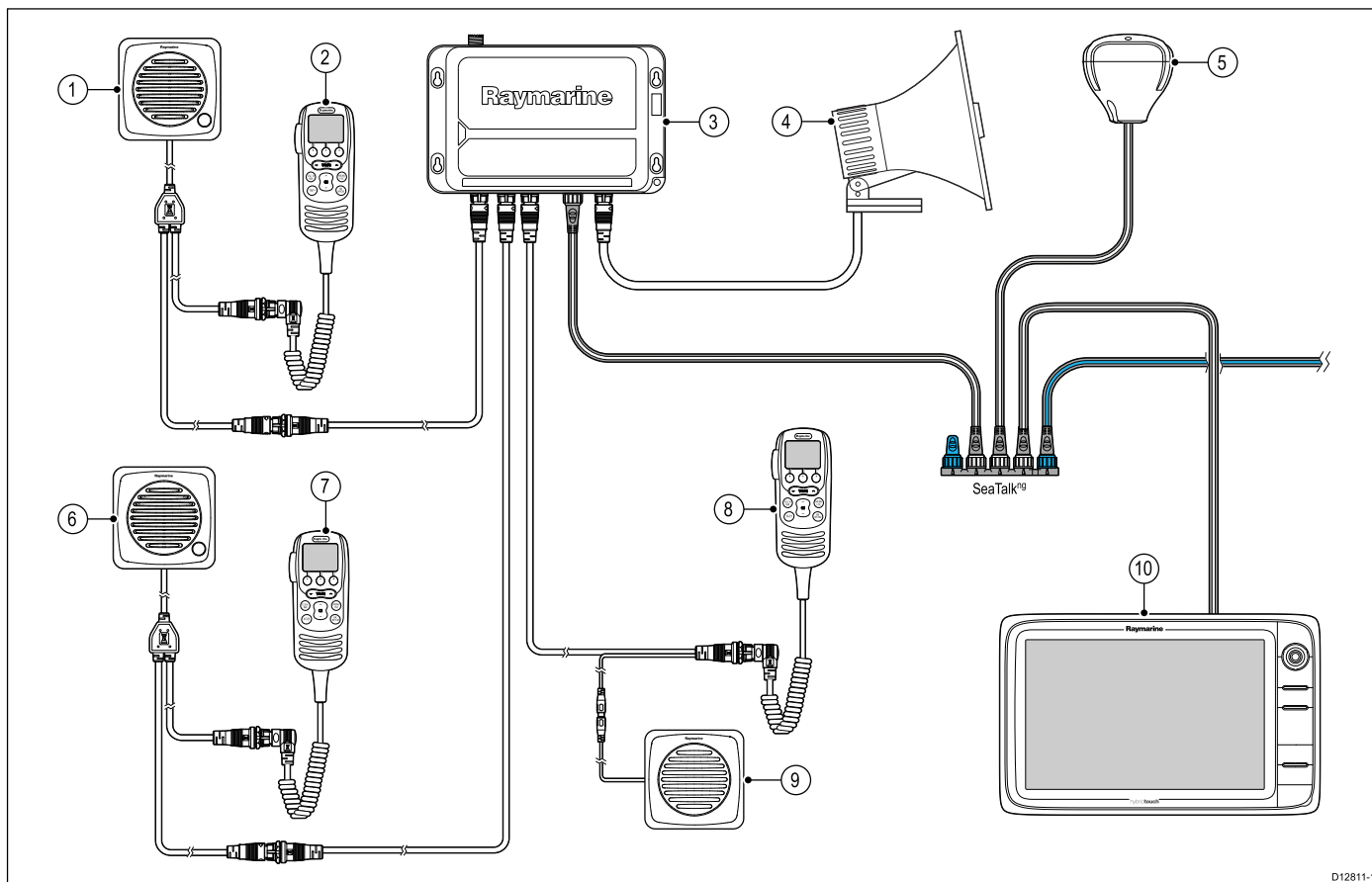

D12811-1

1. Station 1 active speaker
2. Station 1 handset
3. Ray260 base station
4. Loud hailer
5. GPS receiver
6. Station 2 active speaker
7. Station 2 handset
8. Station 3 handset
9. Station 3 passive speaker
10. Multifunction display

# SVIB

**Note:** Each station can support connection of 1 passive OR 1 active speaker.

### 3.3 Installation checklist

Installation includes the following activities:

Installation Task	
1	Plan your system.
2	Obtain all required equipment and tools.
3	Site all equipment.
4	Route all cables.
5	Drill cable and mounting holes.
6	Make all connections into equipment.
7	Secure all equipment in place.
8	Power on and test the system.

### 3.4 Schematic diagram

A schematic diagram is an essential part of planning any installation. It is also useful for any future additions or maintenance of the system. The diagram should include:

- Location of all components.
- Connectors, cable types, routes and lengths.



### 3.5 System protocols

Your product can send and receive position information, e.g. latitude and longitude using any of the following protocols:

- SeaTalk<sup>ng</sup>
- NMEA 2000
- NMEA 0183

Using these protocols enables your radio to send position information to other devices in your system whenever it receives:

- a response to a DSC position request.
- a DSC distress call

**Note:** You may find that your product or system does not use all of the protocols described in this section.

#### Seatak<sup>ng</sup>

SeaTalk<sup>ng</sup> (Next Generation) is an enhanced protocol for connection of compatible marine instruments and equipment. It replaces the older SeaTalk and SeaTalk<sup>2</sup> protocols.

SeaTalk<sup>ng</sup> utilizes a single backbone to which compatible instruments connect using a spur. Data and power are carried within the backbone. Devices that have a low draw can be powered from the network, although high current equipment will need to have a separate power connection.

SeaTalk<sup>ng</sup> is a proprietary extension to NMEA 2000 and the proven CAN bus technology. Compatible NMEA 2000 and SeaTalk / SeaTalk<sup>2</sup> devices can also be connected using the appropriate interfaces or adaptor cables as required.

#### NMEA 2000

NMEA 2000 offers significant improvements over NMEA 0183, most notably in speed and connectivity. Up to 50 units can simultaneously transmit and receive on a single physical bus at any one time, with each node being physically addressable. The standard was specifically intended to allow for a whole network of marine electronics from any manufacturer to communicate on a common bus via standardized message types and formats.

#### NMEA 0183

The NMEA 0183 Data Interface Standard was developed by the National Marine Electronics Association of America. It is an international standard to enable equipment from many different manufacturers to be connected together and share information.

The NMEA 0183 standard carries similar information to SeaTalk. However it has the important difference that one cable will only carry information in one direction. For this reason NMEA 0183 is generally used to connect a data receiver and a transmitter together, e.g. a compass sensor transmitting heading to a radar display. This information is passed in 'sentences', each of which has a three letter sentence identifier. It is therefore important when checking compatibility between items that the same sentence identifiers are used some examples of which are:

- VTG - carries Course and Speed Over Ground data.
- GLL - carries latitude and longitude.
- DBT - carries water depth.
- MWV - carries relative wind angle and wind speed data.

#### NMEA Baud rates

The NMEA 0183 standard operates at a number of different speeds, depending upon the particular requirement or equipment capabilities. Typical examples are:

- 4800 baud rate. Used for general purpose communications, including FastHeading data.
- 38400 baud rate. Used for AIS and other high speed applications.

### 3.6 Parts supplied

The parts supplied with your Ray260 are shown below.

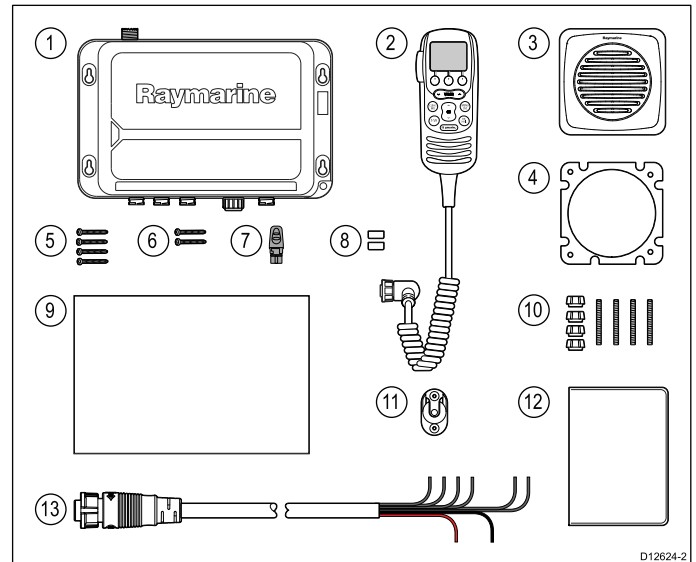

1	Ray260 Base station
2	Ray260 Handset
3	Ray260 speaker including cable (depending on variant the speaker may be passive or active.)
4	Speaker gasket
5	4 x screws for base station mounting
6	2 x Screws for handset mounting
7	SeaTalk <sup>ng</sup> blanking plug
8	2 x handset station blanking plugs
9	Handset extension kit
10	4 x Thumb nut and studs for speaker mounting
11	Handset mounting clip
12	Documentation pack
13	Power / Data cable 1 m (3.3 ft.)

#### Handset extension kit contents

The handset extension kit includes the parts shown below.

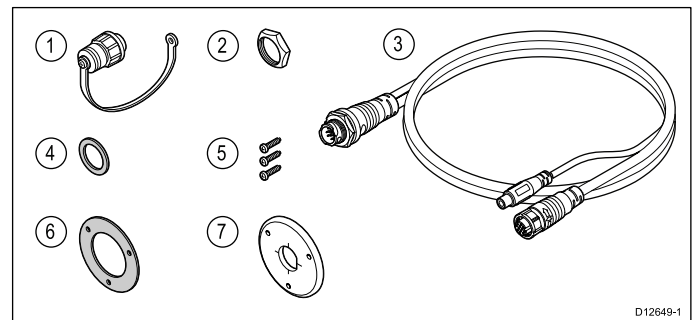

1	Splash-proof cap
2	Nut
3	Handset adaptor cable 10 m (32.8 ft.)
4	Washer
5	3 x Mounting screws
6	Gasket
7	Mounting plate

SWIB

# Chapter 4: Cables and connections

## Chapter contents

- 4.1 General cabling guidance on page 20
- 4.2 Connections overview on page 20
- 4.3 Power connection on page 21
- 4.4 NMEA 0183 connection on page 22
- 4.5 Loud hailer connection on page 22
- 4.6 Handset connection on page 23
- 4.7 Passive speaker connection on page 23
- 4.8 Active speaker connection on page 24
- 4.9 SeaTalk<sup>ng</sup> connection on page 24



## 4.1 General cabling guidance

### Cable types and length

It is important to use cables of the appropriate type and length

- Unless otherwise stated use only standard cables of the correct type, supplied by Raymarine.
- Ensure that any non-Raymarine cables are of the correct quality and gauge. For example, longer power cable runs may require larger wire gauges to minimize voltage drop along the run.

### Routing cables

Cables must be routed correctly, to maximize performance and prolong cable life.

- Do NOT bend cables excessively. Wherever possible, ensure a minimum bend diameter of 200 mm (8 in) / minimum bend radius of 100 mm (4 in).

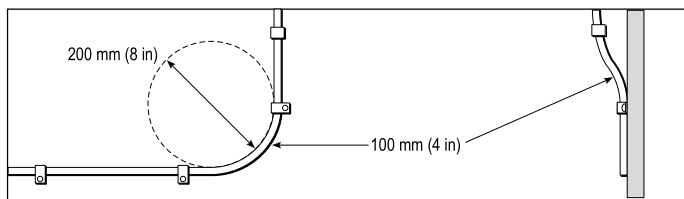

- Protect all cables from physical damage and exposure to heat. Use trunking or conduit where possible. Do NOT run cables through bilges or doorways, or close to moving or hot objects.
- Secure cables in place using tie-wraps or lacing twine. Coil any extra cable and tie it out of the way.
- Where a cable passes through an exposed bulkhead or deckhead, use a suitable watertight feed-through.
- Do NOT run cables near to engines or fluorescent lights.

Always route data cables as far away as possible from:

- other equipment and cables,
- high current carrying ac and dc power lines,
- antennae.

### Strain relief

Ensure adequate strain relief is provided. Protect connectors from strain and ensure they will not pull out under extreme sea conditions.

### Circuit isolation

Appropriate circuit isolation is required for installations using both AC and DC current:

- Always use isolating transformers or a separate power-inverter to run PC's, processors, displays and other sensitive electronic instruments or devices.
- Always use an isolating transformer with Weather FAX audio cables.
- Always use an isolated power supply when using a 3rd party audio amplifier.
- Always use an RS232/NMEA converter with optical isolation on the signal lines.
- Always make sure that PC's or other sensitive electronic devices have a dedicated power circuit.

### Cable shielding

Ensure that all data cables are properly shielded that the cable shielding is intact (e.g. hasn't been scraped off by being squeezed through a tight area).

### Blanking plugs

Connectors not in use should be protected using blanking plugs.

Connectors on the product or accompanying cables, that are not in use (not connected), should be covered using blanking plugs if supplied.

## 4.2 Connections overview

The connections shown below are available on the Ray260 Base station.

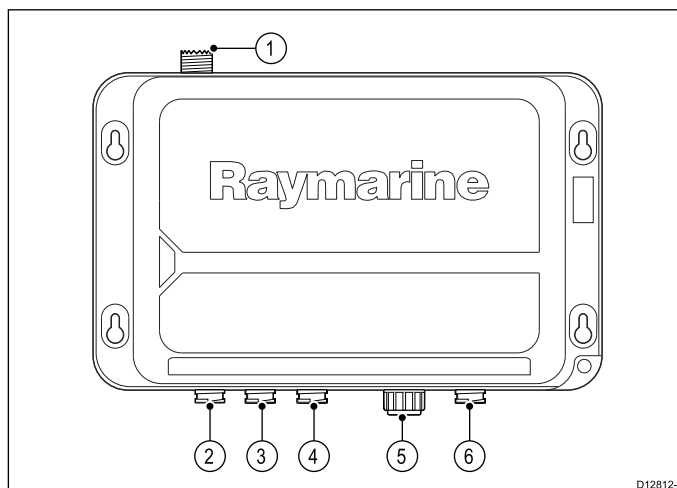

1	Antenna connection
2	HS1 — Station 1 port
3	HS2 — Station 2 port
4	HS3 — Station 3 port
5	SeaTalk <sup>ng</sup> connection
6	Power / NMEA 0183 / Loud hailer connection

### 4.3 Power connection

The power supply should be connected as shown below:

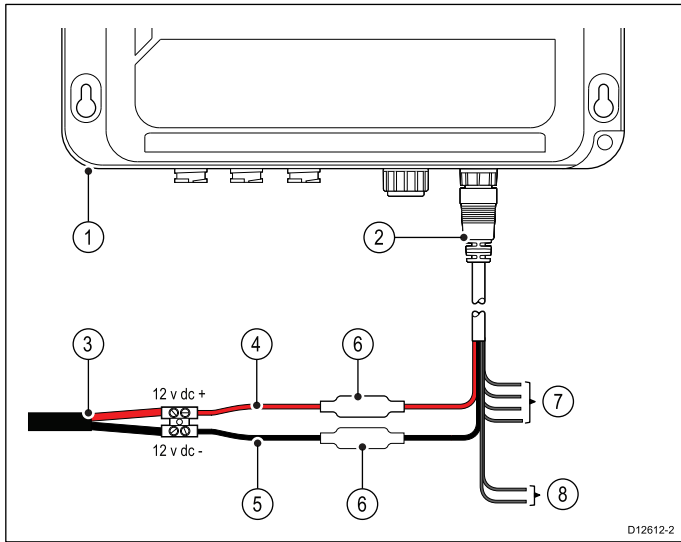

1. Ray260 base station
2. Power cable
3. Vessel power supply
4. Red positive wire
5. Black negative wire.
6. In-line 10 A fuse.
7. NMEA 0183 wires.
8. Loud hailer wires

The unit should be powered from a dedicated circuit breaker, that has appropriate circuit protection. If the unit is not powered directly from a dedicated circuit breaker then a separate isolation switch should be fitted to the units power supply.

The unit is powered on when the power cable is attached to the vessel's power supply.

**Important:** When the vessel is unattended the unit should always be switched off by the circuit breaker or isolation switch.



#### Warning: Chassis grounding

Do NOT ground this product using the chassis ground terminal.

Grounding this product to a vessel's RF ground may cause galvanic corrosion.

### Grounding

This product is grounded through the 0 V dc negative wire on the power cable and does not require a drain (shield) to be connected to the base station's ground terminal.



#### Warning: Positive ground systems

Do not connect this unit to a system which has positive grounding.

### Breakers, fuses and circuit protection

The power cable includes an in-line fuse. It is recommended that you fit an additional thermal breaker or fuse at the distribution panel.

In-line fuse rating	Thermal breaker rating
10 A in-line slow-blow fuse fitted within power cable	7 A (if only 1 device is connected)

**Note:** The suitable fuse rating for the thermal breaker is dependent on the number of devices you are connecting. If in doubt consult an authorized Raymarine dealer.

### Sharing a breaker

Where more than 1 piece of equipment shares a breaker you must provide protection for the individual circuits. E.g. by connecting an in-line fuse for each power circuit.

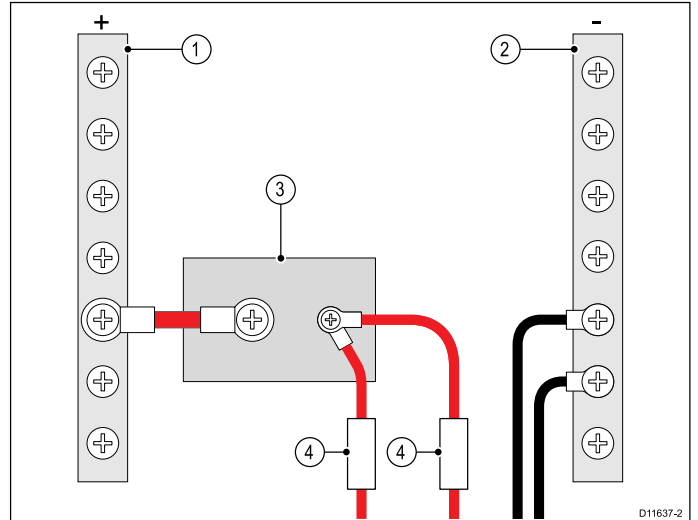

1	Positive (+) bar
2	Negative (-) bar
3	Circuit breaker
4	Fuse

Where possible, connect individual items of equipment to individual circuit breakers. Where this is not possible, use individual in-line fuses to provide the necessary protection.

DBB

## 4.4 NMEA 0183 connection

The NMEA 0183 wires on the power/data cable can be used to connect the radio to a GPS receiver or a Raymarine multifunction display.

**Note:** Connections cannot be made using SeaTalk<sup>ng</sup> and NMEA 0183 at the same time.

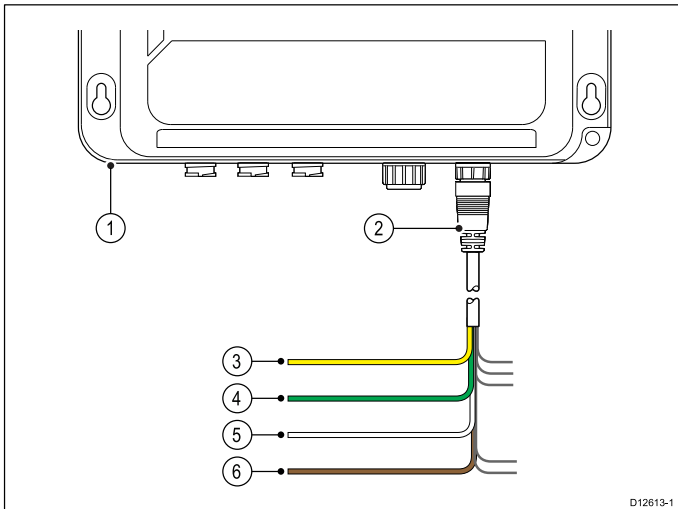

1. Ray260 base station.
2. Power/data cable.
3. Yellow – Receive positive (+) wire.
4. Green – Receive negative (-) wire.
5. White – Transmit positive (+) wire.
6. Brown – Transmit negative (-) wire.

The NMEA wires on the product's power / data cable should be connected to a compatible NMEA 0183 devices as shown in the table below:

Ray260		NMEA 0183 device
Yellow – Receive positive (+)	to	Transmit positive (+)
Green – Receive negative (-)	to	Transmit negative (-)
White – Transmit positive (+)	to	Receive positive (+)
Brown – Transmit negative (-)	to	Receive negative (-)

## Connecting NMEA 0183 wires

NMEA 0183 wires should be connected securely and covered to prevent corrosion.

## 4.5 Loud hailer connection

A single 30 watt loud hailer can be connected to the base station via the loud hailer wires on the power / data cable.

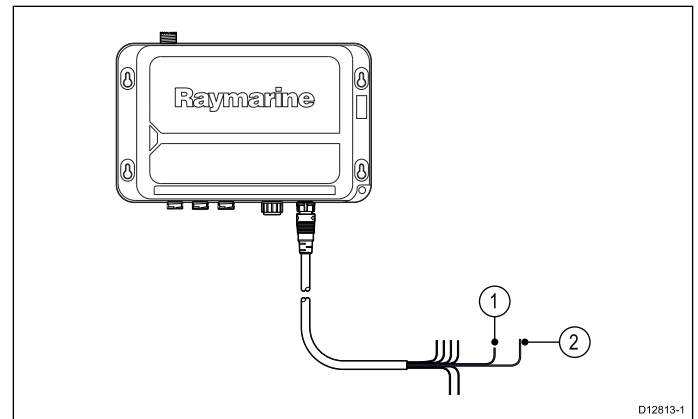

1	(+) Hailer wire (Purple)
2	(-) Hailer wire (Gray)

## Connecting loud hailer wires

Loud hailer wires should be connected securely and covered to prevent corrosion.

## 4.6 Handset connection

Up to 3 stations can be connected to the unit.

A station must include a handset and can include a passive or an active speaker. A handset must be connected to the station 1 port (HS1), this handset has priority over other connected handsets.

Optional extension and adaptor cables can be used to increase the distance of the handset from the base station, or to add a passive speaker. The maximum extended cable length from base station to handset is 50 metres (164 ft).

**Note:** You cannot connect an active and a passive speaker to the same station.

Refer to [4.7 Passive speaker connection](#) and [4.8 Active speaker connection](#) for details on connecting the handset and speakers.

### Connecting handsets and cables

Follow the steps below to connect handsets and extension cables together.

1. Ensure the cable connectors are correctly orientated.
2. Ensure connectors are fully inserted.
3. Tighten locking collars by Rotating clockwise.

## 4.7 Passive speaker connection

A passive speaker can be connected to the handset cable using the external speaker pigtail wires.

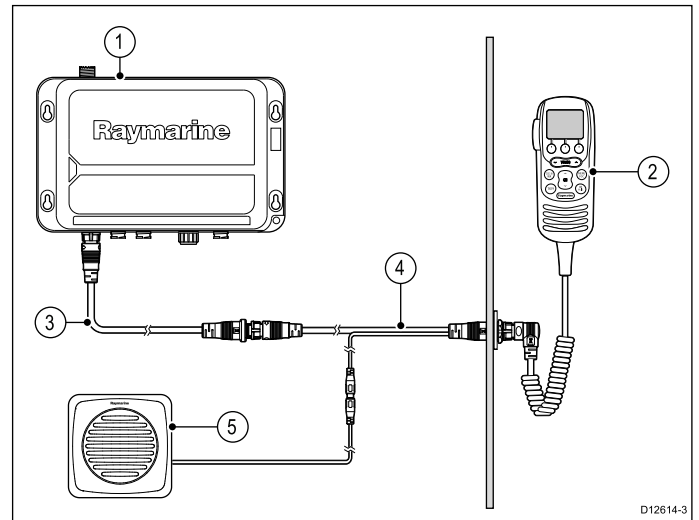

1. Base station
2. Handset
3. Handset extension cable (optional)
4. Handset adaptor cable
5. Passive speaker

**Note:** When using the optional handset extension cable the extension cable must be connected to the base station side of the speaker.

SVIB

## 4.8 Active speaker connection

An active speaker can be connected using the handset cable or handset extension cable.

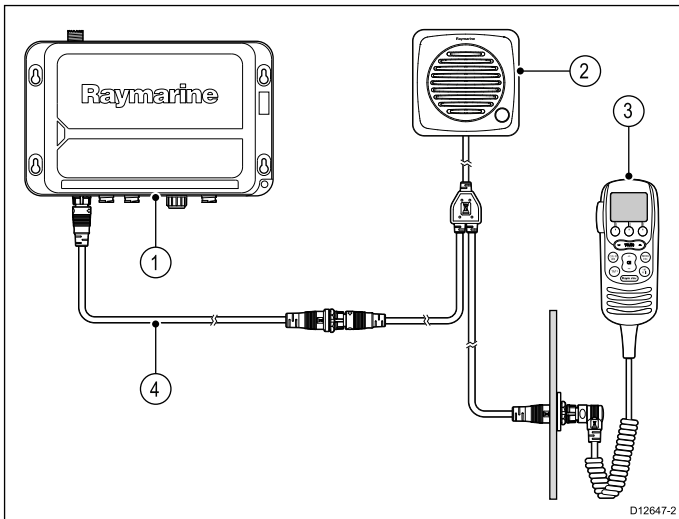

1. Base station
2. Active speaker
3. Handset
4. Handset extension cable (optional)

**Note:** When using the optional handset extension cable the extension cable must be connected to the base station side of the speaker

### Connecting active speakers

Active speakers must be connected to the system as described below.

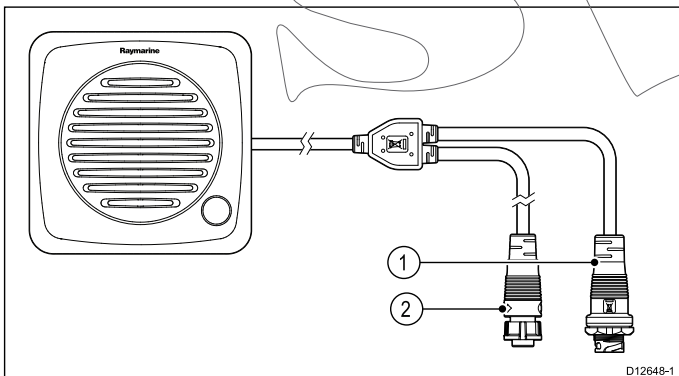

1	Connector (1) must be connected either directly to the handset or to the handset via an extension cable
2	Connector (2) must be connected either directly to the base station or to the base station via an extension cable

1. Ensure the cable connectors are correctly orientated.
2. Ensure connectors are fully inserted.
3. Tighten locking collars by Rotating clockwise.

## 4.9 SeaTalk<sup>ng</sup> connection

The Ray260 can interface with Raymarine GPS receivers and Raymarine multifunction displays using the SeaTalk<sup>ng</sup> connector.

A Raymarine SeaTalk<sup>ng</sup> GPS receiver cannot be connected directly to the Base station as GPS receivers are powered via the SeaTalk<sup>ng</sup> backbone.

**Note:** If your unit has both SeaTalk<sup>ng</sup> and NMEA 0183 connected then you must select which connection you want to be active using the **DSC Menu > Connection > Interface** menu options. Refer to [6.8 Selecting NMEA 0183 or SeaTalk<sup>ng</sup> connection](#) for details.

### Connecting SeaTalk<sup>ng</sup>

The Ray260 can interface with Raymarine GPS receivers and Raymarine multifunction displays through the SeaTalk<sup>ng</sup> connector.

Before connecting to SeaTalk<sup>ng</sup>, refer to the *SeaTalk<sup>ng</sup> Reference Manual*, to ensure that the maximum permitted Load Equivalence Number (LEN), for the SeaTalk<sup>ng</sup> system is not exceeded once this product is connected.

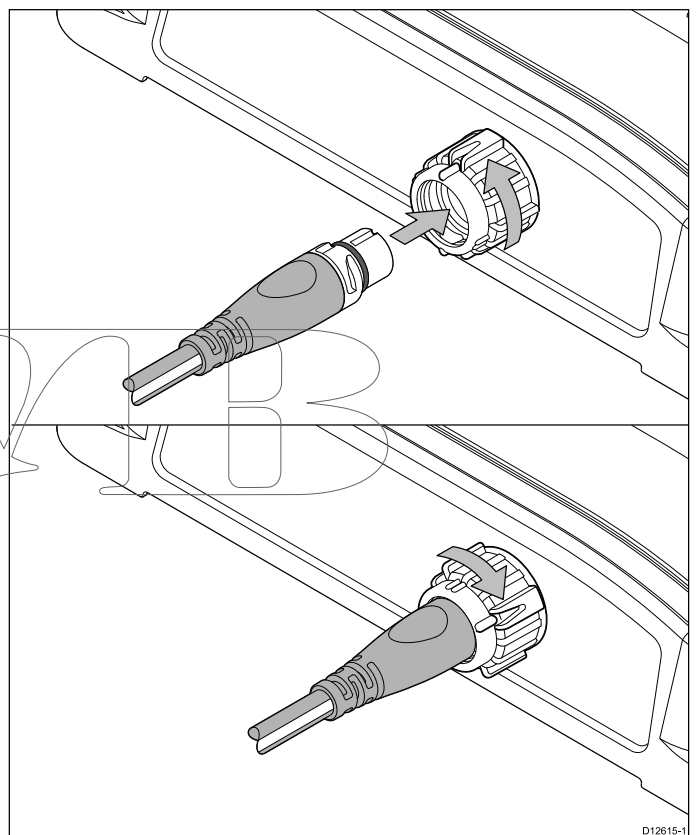

1. Rotate the SeaTalk<sup>ng</sup> connector's locking collar anti clockwise, to the unlock position.
2. Ensure the spur cable connector is correctly orientated.
3. Fully insert the spur cable connector into the SeaTalk<sup>ng</sup> connector on the unit.
4. Rotate the locking collar clockwise 2 clicks, to the locked position.



# Chapter 5: Location and mounting

## Chapter contents

- [5.1 General location requirements on page 26](#)
- [5.2 Base station dimensions on page 27](#)
- [5.3 Base station mounting on page 28](#)
- [5.4 Speaker mounting on page 28](#)
- [5.5 Handset mounting on page 29](#)

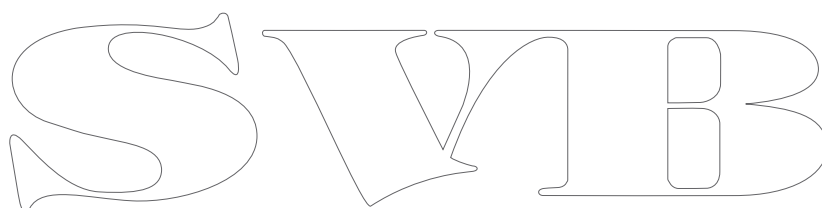

## 5.1 General location requirements

When selecting a location for the unit it is important to consider a number of factors.

## Power supply

Select a location that is as close as possible to the vessel's DC power supply. This will help to keep cable runs to a minimum.

## Antenna mounting and EME exposure

Ensure that the antenna is connected to the radio before transmission.

Raymarine declares a Maximum Permissible Exposure (MPE) radius of 1.5 metres (4.9 ft) (per OET Bulletin 65) for this system, assuming 25 watts output to an omnidirectional antenna of 3dBi gain or less.

For watercraft with suitable structures, the antenna base must be at least 3.5 metres (11.5 ft) above the main deck to meet the MPE for persons up to 2 metres (6.6 ft) tall. For watercraft without such structures, the antenna must be mounted so that its base is a minimum of 1.5 metres (4.9 ft) vertically from heads of all persons.

The antenna must be isolated from the vessel's metalwork using an insulated (e.g. plastic) mounting bracket.

## Compass safe distance

To prevent potential interference with the vessel's magnetic compasses, ensure an adequate distance is maintained from the product.

When choosing a suitable location for the product you should aim to maintain the maximum possible distance from any compasses. Typically this distance should be at least 1 m (3 ft) in all directions. However for some smaller vessels it may not be possible to locate the product this far away from a compass. In this situation, when choosing the installation location for your product, ensure that the compass is not affected by the product when it is in a powered state.

## Ventilation requirements

To provide adequate airflow:

- Ensure that equipment is mounted in a compartment of suitable size.
- Ensure that ventilation holes are not obstructed.
- Ensure adequate separation of equipment.

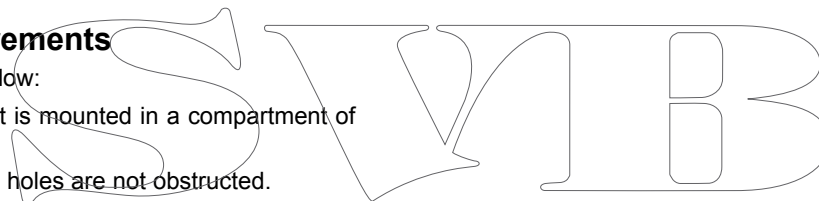

## Mounting surface requirements

Ensure units are adequately supported on a secure surface. Do NOT mount units or cut holes in places which may damage the structure of the vessel.

## Cable routing requirements

Ensure the unit is mounted in a location which allows proper routing and connection of cables:

- Minimum cable bend radius of 100 mm (3.94 in) is required unless otherwise stated.
- Use cable supports to prevent stress on connectors.

## Water ingress

### Base station

Although the base station is waterproof to IPX6 standard, it is recommended that the base station be mounted below decks, in an area protected from prolonged and direct exposure to rain and salt spray.

### Handset and speakers

The handsets, passive speakers, and active speakers are waterproof to IPX7 and can be mounted above or below decks. Although the unit is waterproof, it is good practice to locate it in an area protected from prolonged and direct exposure to rain and salt spray.

## Electrical interference

Select a location that is far enough away from devices that may cause interference, such as motors, generators and radio transmitters/receivers.

## 5.2 Base station dimensions

The dimensions of the Ray260 base station are shown below.

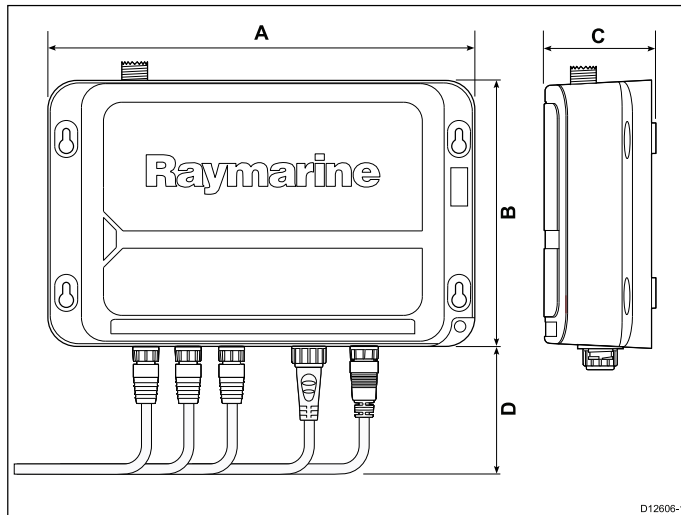

A	269.5 mm (10.6 in)
B	168 mm (6.6 in)
C	66.12 mm (2.6 in)
D	80.0 mm (3.15 in)

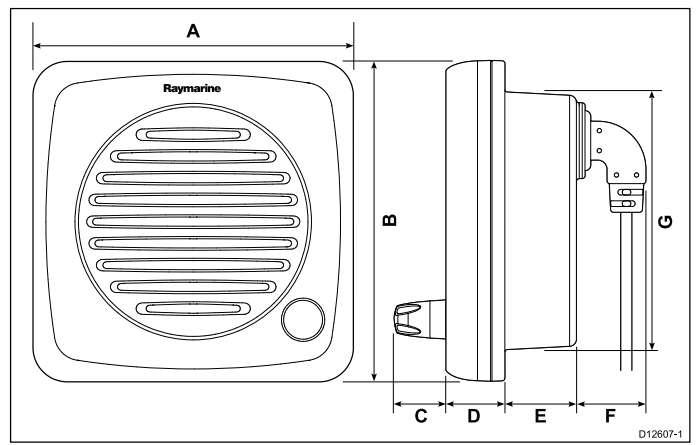

A	112 mm (4.4 in)
B	112 mm (4.4 in)
C	20.3 mm (0.799 in)
D	15.55 mm (0.61 in)
E	25 mm (0.98 in)
F	30 mm (1.18 in)
G	91.5 mm (3.6 in)

## Handset dimensions

The dimensions of the handset are shown below.

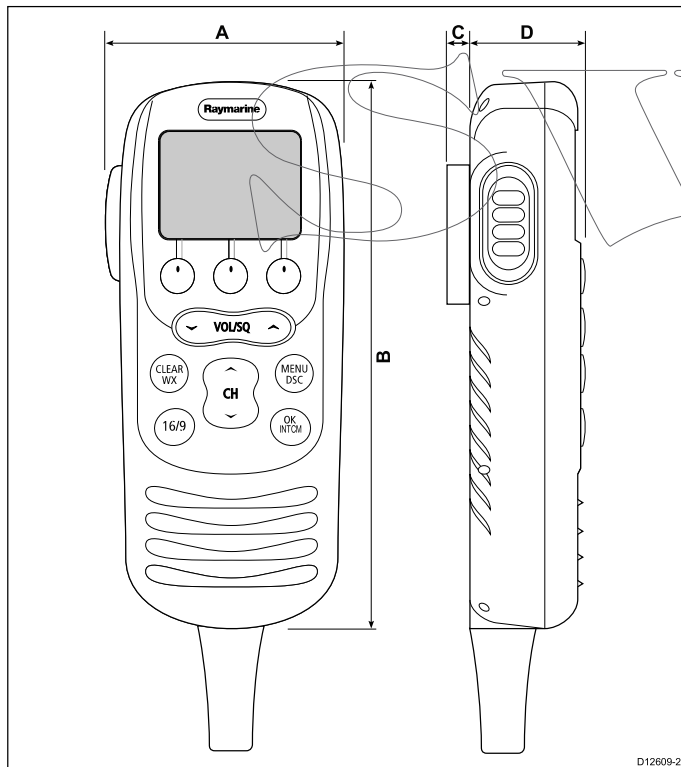

A	65.4 mm (2.57 in)
B	154.4 mm (6.07 in)
C	7 mm (0.275 in)
D	38.5 mm (1.5 in)

## Speaker dimensions

The dimensions of the Ray260 passive / active speaker are shown below.

**Note:** The passive speaker does not have a volume control knob.

## 5.3 Base station mounting

In order to mount the Ray260 base station follow the steps below.

**Note:** Raymarine recommends mounting the unit vertically.

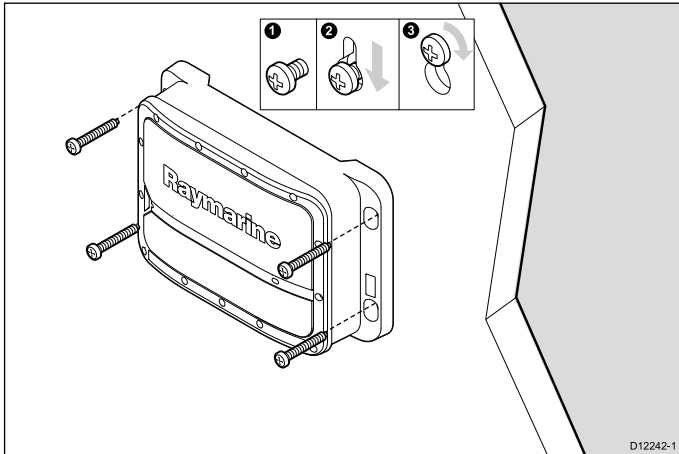

1. Check the selected location for the unit, a clear flat area with suitable clearance for air ventilation around the unit is required.
2. Secure the Base station mounting template in the chosen location using adhesive tape.
3. Drills 4 holes at the marked location on the template.
4. Remove the mounting template.
5. Screw in the supplied fixing screws approximately half way into the holes.
6. Place the unit onto the fixing screws.
7. Push the unit down to engage the key slots in the unit.
8. Tighten the screws.

**Note:** Drill bit, tap size and tightening torque is dependent on the thickness and type of material the unit is to be mounted on.

## 5.4 Speaker mounting

In order to mount a passive or active speaker follow the steps below.

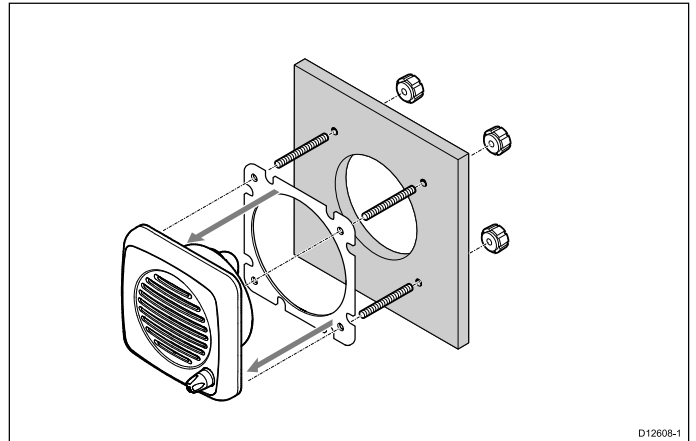

The speaker is designed to be flush mounted.

1. Check the selected location for the unit, a clear flat area is required.
2. Cut out the identified shaded area(s) from the mounting template
3. Fix the speaker mounting template (supplied) to the selected location, using adhesive tape.
4. Drill out the required mounting holes, as indicated on the mounting template.
5. If possible use an appropriate size hole cutting saw and cut out the center hole, or
6. Using a suitable hole cutting saw, make pilot holes in each corner of the cut out area and using a jigsaw cut along the inside edge of the cut out line.
7. Remove the mounting template.
8. Ensure that the unit fits into the removed area and then file around the cut edges until smooth.
9. Feed the speaker cable through the cut out hole and connect the opposite end of the speaker wire to the relevant connector.
10. Attach the 4 x mounting studs to the rear of the speaker.
11. Hold the speaker into place and secure by tightening the provided thumb nuts onto the mounting studs.

## 5.5 Handset mounting

In order to mount the handset clip follow the steps below.

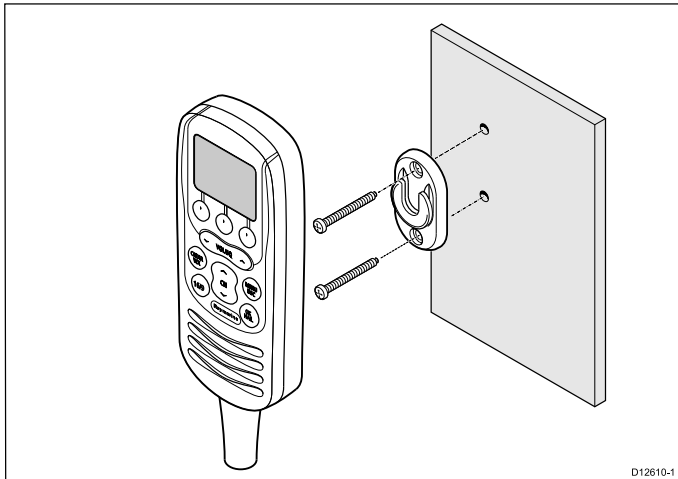

1. Check the selected location for the handset clip, a clear flat area is required, with sufficient space around it to place and remove the handset.
2. Using a pencil, offer up the handset clip to the desired location and mark the location of the screw holes on the mounting surface.
3. Drill the mounting holes using a suitable size drill bit.
4. Hold the clip in place and secure using the screws provided.

**Note:** Drill bit, tap size and tightening torque is dependent on the thickness and type of material the unit is to be mounted on.

5. Hold the clip in place and secure using the screws provided.
6. Pull the connector end of the cable through the hole in the mounting panel.

**Note:** The handset extension cable includes a speaker cable. If you are not connecting an external passive speaker then cover the speaker cable with waterproof tape or sealant to prevent corrosion.

7. Insert the washer (labelled 6 in the diagram below) over the end of the connector.
8. Insert the gasket (labelled 4 in the diagram above) over the end of the connector.
9. Insert the mounting plate (labelled 3 in the diagram above) over the end of the connector, ensuring that the screw holes are aligned with the respective holes in the gasket and the mounting panel.
10. Place the nut (labelled 5 in the diagram above) over the connector and tighten clockwise using a 13/16 in. (21 mm) socket wrench.
11. Align the small end of the splash-proof cap (labelled 1 in the diagram above) with one of the screw holes on the gasket.
12. Secure the mounting plate to the mounting surface using the supplied screws.
13. Attach the handset or microphone to the cable connector and rotate clockwise to secure.
14. Connect the opposite end of the cable to the required connector either on the base station or to another pass-through panel plate connector.

**Note:** Drill bit, tap size and tightening torque is dependent on the thickness and type of material the unit is to be mounted on.

## Pass-through panel plate mounting

When installing the handset use the supplied, handset extension cable kit to pass the cable through a panel (e.g. bulkhead).

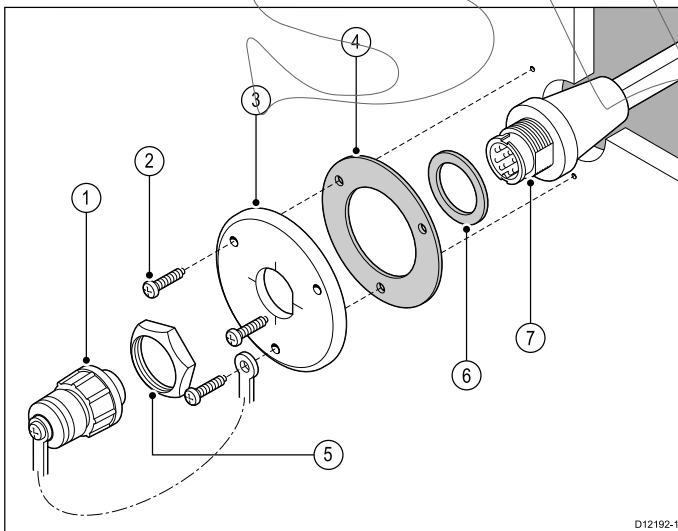

1	Splash-proof cap
2	Mounting screws x3
3	Mounting plate
4	Gasket
5	Nut
6	Washer
7	Extension cable connector

1. Check the selected location for the mounting of the handset cable extension mounting plate, a clear flat area is required.
2. Using a pencil, offer up the mounting plate to the desired location and mark the location of the screw holes and the center hole on the mounting surface.
3. Drill the mounting holes using a suitable size drill bit.
4. Drill the center hole using a 25 mm (1 in.) hole cutting saw.

Location and mounting

SWIB

# Chapter 6: Getting started

## Chapter contents

- 6.1 Controls on page 32
- 6.2 Switching the radio on on page 32
- 6.3 Switching the radio off on page 33
- 6.4 Voltage detection on page 33
- 6.5 Handset display LCD overview on page 34
- 6.6 Entering your MMSI number on page 35
- 6.7 Entering your ATIS ID on page 36
- 6.8 Selecting NMEA 0183 or SeaTalk<sup>®</sup> connection on page 37
- 6.9 Regional programming on page 37
- 6.10 Adjusting the LCD backlight level on page 38
- 6.11 Adjusting the LCD contrast on page 38
- 6.12 Changing the transmit power on page 39
- 6.13 GPS setup on page 39
- 6.14 Handset station priority on page 40

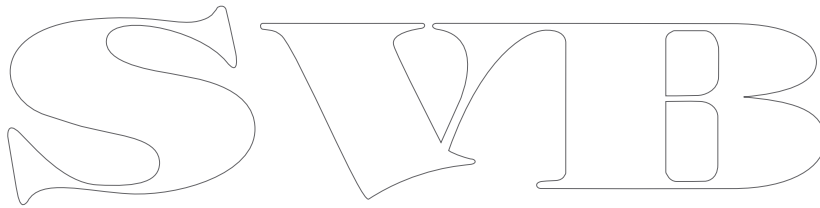

## 6.1 Controls

You can access all functions, with the exception of adjusting the active speaker volume, from the handset.

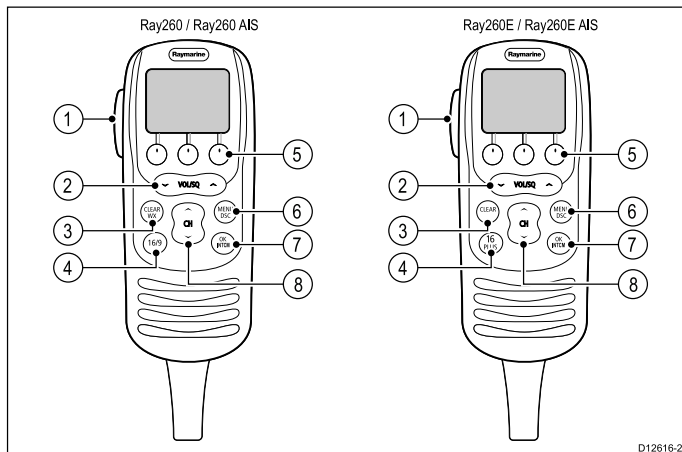

### 1. PTT (Push to talk)

Press and hold to send a voice message. Release to return to receive mode.

**Note:** The maximum transmit time is limited to 5 minutes to prevent un-intentional transmissions from occupying the VHF channel.

### 2. VOL/SQ

- Adjusts volume up and down.
- Press and release the center button to activate the squelch threshold adjustment.
- With squelch activated use the up and down buttons to increase and decrease the squelch level.

### 3. CLEAR/WX or CLEAR

- Press and release to terminate a function and return to the last used channel.
- Press and hold for 3 seconds to select the weather mode (North America and Canada only).

### 4. 16/9 or 16 PLUS

- Press to power up the radio.
- Press and hold for 5 seconds to power off.
- When powered on press to cycle between priority channels and last used channel.

### 5. Soft buttons

The soft button's functions change according to context, such as navigate through menus or to make a menu selection. Press to select the corresponding functions as identified by the on-screen label.

### 6. MENU / DSC

- Press and release to access the radio menu.
- Press and hold for 3 seconds to access the DSC menu.

### 7. OK/INTCM

- Press and release on menu options to confirm a selection or value.
- Press and hold for 3 seconds to open the intercom menu.

### 8. Channel Up and Down

- Moves the selected channel up or down.
- Scrolls up or down through menu items.

### 9. DISTRESS

The Distress button is located on the back of the handset. Push up the spring loaded cover and press this button to make a DSC distress call.

## 6.2 Switching the radio on

To power the radio on using any connected handset follow the steps below.

With the power off:

1. Press the red **16/9 / 16 PLUS** button.

The radio will power up and the radio's MMSI number is displayed on-screen for approximately 3 seconds before displaying the main screen.

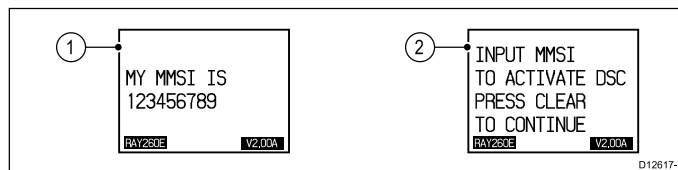

1	Startup screen with MMSI registered (auto dismisses after 3 seconds).
2	Startup screen with no MMSI registered (Press CLEAR to dismiss).

**Note:** If no MMSI number has been programmed then an alarm is sounded and a warning message is displayed INPUT MMSI TO ACTIVATE DSC - PRESS CLEAR TO CONTINUE. DSC functions will not be available until an MMSI number has been entered.



## 6.3 Switching the radio off

To switch the radio off follow the steps below.

With the radio switched on:

1. Press and hold the **16/9** button for 5 seconds.

## 6.4 Voltage detection

The radio detects the power supply voltage and a warning is displayed if the supply voltage is under or over recommended power.

An over voltage warning is displayed if the radio's supply voltage is between 15.7 V dc and 16.0 V dc. The radio will automatically power down if the supply voltage exceeds 16.5 V dc, the warning will be cancelled when the radios power supply voltage fails below 15.6 V dc.

An under voltage alarm is displayed if the radio's supply voltage is 10.5 V dc or less. The radio will be unable to operate reliably below 10.5 V dc.

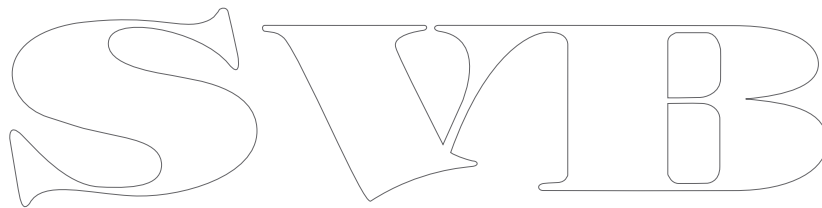
A large, stylized outline logo consisting of the letters 'S', 'V', 'I', and 'B' in a decorative, serif font. The letters are connected and have a classic, elegant appearance.

## 6.5 Handset display LCD overview

The information below describes the on-screen characters and icons which the radio displays on the main screen and what they mean.

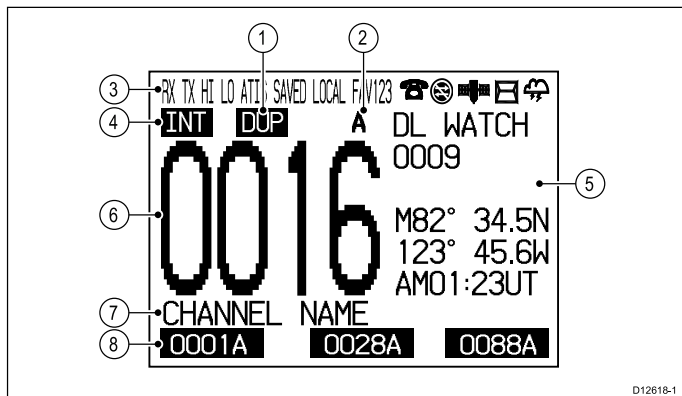

### 1. Duplex

- **DUP** — Indicates the current channel is duplex.

### 2. Channel suffix

- **A** — Indicates that the currently selected US or Canadian channel is simplex, although its International equivalent is semi-duplex (05A, for example). This channel uses the transmit frequency of the International channel for transmitting and receiving. If a channel is simplex in all 3 channel sets (US, Canadian and International — channel 6 for example), the does not require the A suffix.

**Note:** Simplex means that the radio transmits and received on the same frequency for this channel. Semi-duplex channels use separate frequencies to transmit and receive.

- **B** — Indicates that you cannot transmit on the currently selected channel as it is receive only. Used with Canadian channels only.

### 3. ICONS

The icon definitions are listed below:

- **RX (Receiving)** — Indicates that the radio is receiving a radio signal.
- **TX (Transmitting)** — Indicates the PTT button is being pressed and the radio is transmitting.
- **HI (High power)** — Indicates that the transmitters power is set to high (25 watts).
- **LO (Low power)** — Indicates that the transmitters power is set to low (1 watt).
- **ATIS (ATIS active)** — Indicates ATIS transmission is enabled. Only available in European countries using the international channel set.
- **SAVED (Memory mode)** — Indicates the current channel has been saved in memory. Appears during saved scan and priority saved scan modes.
- **LOCAL (Local/distant mode)** — Indicates the radio is in local reception mode, which decreases receiver sensitivity in high traffic areas to decrease unwanted reception.
- **FAV123 (Favorite channel)** — Indicates which of the 3 favorite channel banks is currently selected. Each bank displays a different favorite channel that you have assigned for each of the 3 soft button labels at the bottom of the screen. This gives you a total of 9 favorite channels that you can switch to at the press of a button.

- **Telephone icon** — Indicates that the radio has received a voice mail.
- **Automatic channel changing blocked icon** — Indicates that your radio will not automatically switch to the channel requested by an incoming DSC call but will prompt you to manually accept or decline the channel

change request. Applies to Distress and All ships Urgency calls only.

- **Satellite icon** — Indicates that positional data is available from your GPS.
- **Envelope icon** — When flashing, indicates that the radio has received a DSC call. Details of the call can be viewed in the DSC received calls log.
- **Cloud icon** — Indicates that the radio is monitoring for weather alert broadcasts. US and Canada only.

### 4. Frequency group

Indicates which channel set is selected:

- **USA** — United States of America.
- **INT** — International.
- **CAN** — Canada.
- **WX** — Weather

**Note:** Special licensing is required to receive USA and Canadian channel sets.

### 5. Information

- Indicates radio functions, GPS position data or special conditions, depending on the situation. The screen is different when transmitting/receiving a DSC call or setting up a menu item.

### 6. Channel

Indicates the currently selected channel.

### 7. Channel name

Indicates the channel name.

### 8. Soft button legends

Indicates the current function of the associated soft buttons.

## DSC Call screen overview

When transmitting or receiving a DSC call, specific call information is shown on-screen.

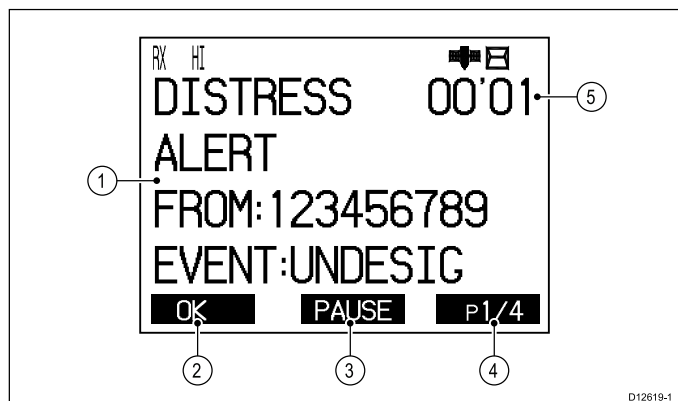

### 1. DSC call information

The DSC call information details.

### 2. Left soft button function

In this example pressing the left soft button will accept the incoming distress call.

### 3. Center soft button function

In this example pressing the center soft button will pause the current DSC call.

### 4. Right soft button function

In this example the right soft button is indicating that the DSC information being shown is page 1 of 4 page of information, pressing the right soft button will display the next page of information.

### 5. Call time

The time the current call has been active.

## Menu screen overview

The radio's menu options can be viewed on-screen.

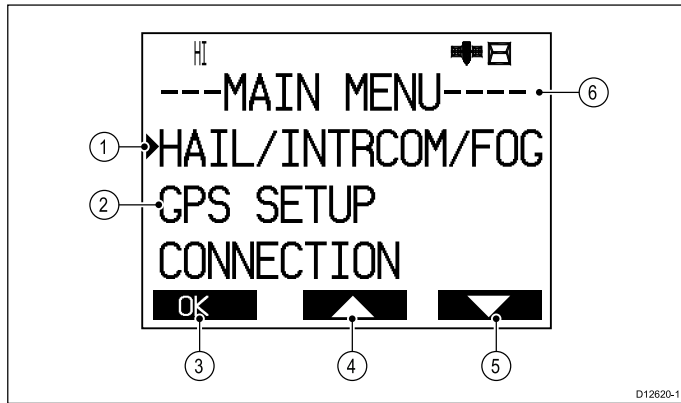

1. **Selection arrow**  
Indicates the currently highlighted menu item.
2. **Menu items**  
This is a list of the available menu items.
3. **OK**  
Selecting OK will open the highlighted menu option
4. **Up arrow**  
Indicates that there are more menu options above, which can be accessed by pressing the right soft button.
5. **Down arrow**  
Indicates that there are more menu options below, which can be accessed by pressing the center soft button.
6. **Menu name**  
Indicates the menu currently displayed.

S V E

## 6.6 Entering your MMSI number

To program your radio with your MMSI number follow the steps below.

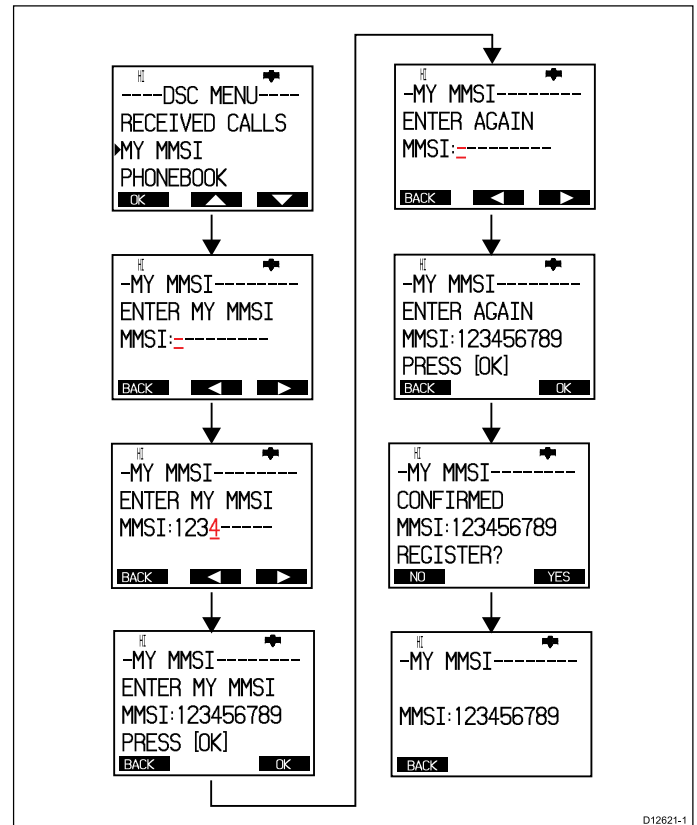

1. Press and hold the **MENU / DSC** button to display the DSC menu.
2. Select **MY MMSI** from the DSC menu.
  - If **NO MMSI ID CONTACT DEALER** is displayed on-screen then you must contact your local Raymarine dealer and request them to input the MMSI number for you.
  - If **ENTER MY MMSI** is displayed then you can manually enter your MMSI. The first character of the blank MMSI number will be highlighted.

**Note:** If '0' is entered as the first digit then the second digit will automatically be changed to a '0'. MMSI numbers beginning with '0' are only for use by the Coast Guard.

3. Use the Channel **Up** and **Down** buttons to cycle through available numbers.
4. Select **Ok** to move to the next character.
5. Repeat steps 3 and 4 above until the full 9 digit MMSI number is displayed on-screen.
6. You can also use the **Right arrow** and **Left arrow** soft buttons to change which character is highlighted.
7. When finished select **Ok** to confirm the MMSI number.  
You will be requested confirm the MMSI number by repeating the entry.
8. With **ENTER AGAIN** displayed on-screen follow steps 3 to 6 above to enter the MMSI number again.
9. Select **Ok** to confirm.
10. If **NOT CONFIRMED** is displayed then select **Back** and repeat steps 2 to 9 above.
11. If **CONFIRMED** is displayed then select **Yes** to confirm and save the MMSI number.  
The saved MMSI number is displayed on-screen (e.g. MMSI:123456789).
12. Select **Back** to go back to the DSC menu.

**Note:** You can only enter the MMSI number once, if you have stored an incorrect MMSI number in your product, the product will have to be reset by an authorized Raymarine dealer.

## 6.7 Entering your ATIS ID

To program your radio with your ATIS ID follow the steps below.

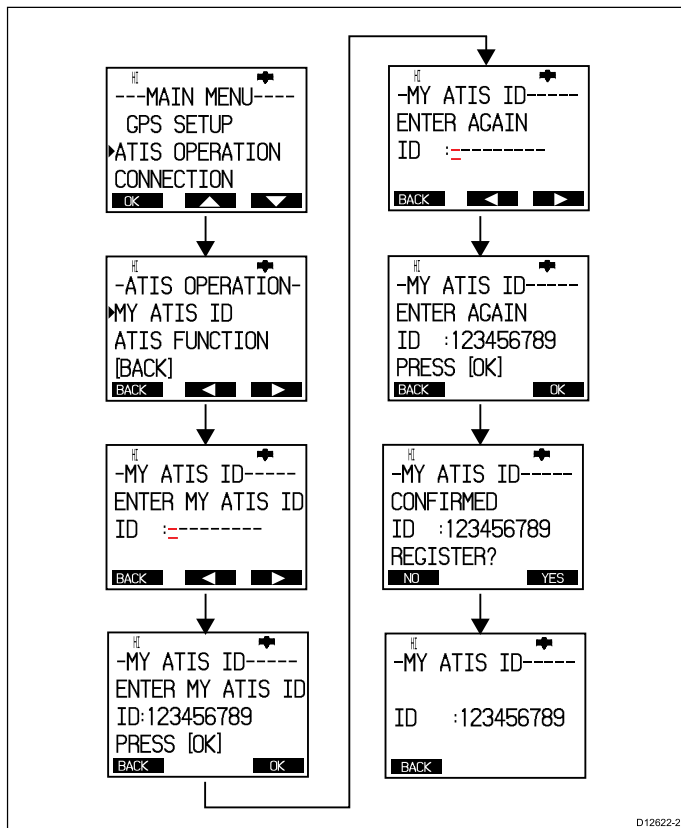

1. Press and release the **MENU / DSC** button to display the main menu.
2. Select **ATIS OPERATION** from the main menu options.
  - If **NO ATIS ID CONTACT DEALER** is displayed on-screen then you must contact your local Raymarine dealer and request them to input the ATIS ID for you.
  - If **ENTER MY ATIS ID** is displayed then you can manually enter your ATIS ID. All ATIS IDs begin with a 9, this is set automatically and not shown on the display.
3. Use the Channel **Up** and **Down** buttons to cycle through available numbers.
4. Select **Ok** to move to the next character.
5. Repeat steps 3 and 4 above until the full ATIS ID is displayed on-screen.
6. You can also use the **Right arrow** and **Left arrow** soft buttons to change which character is highlighted.
7. When finished select **Ok** to confirm the ATIS ID.  
You will be requested confirm the ATIS ID by repeating the entry.
8. With **ENTER AGAIN** displayed on-screen follow steps 3 to 6 above to enter the ATIS ID again.
9. Select **Ok** to confirm.
10. If **NOT CONFIRMED** is displayed then select **Back** and repeat steps 2 to 9 above.
11. If **CONFIRMED** is displayed then select **Yes** to confirm and register the ATIS ID.  
The saved ATIS ID is displayed on-screen (e.g. ID: 123456789).
12. Select **Back** to go back to the ATIS Operation menu.

**Note:** You can only enter the ATIS ID number once, if you have stored an incorrect ATIS ID number in your product, the product will have to be reset by an authorized Raymarine dealer.

## Enabling / Disabling the ATIS function

With the ATIS ID programmed you can now enable or disable the ATIS function as required by following the steps below.

**Note:** If your radio has been configured to use Marcom-C mode then ATIS will be permanently enabled and you will not be able to disable ATIS operation. Marcom-C mode is set by the dealer at point of sale. If you wish to enable or disable Marcom-C, please contact your Raymarine dealer.

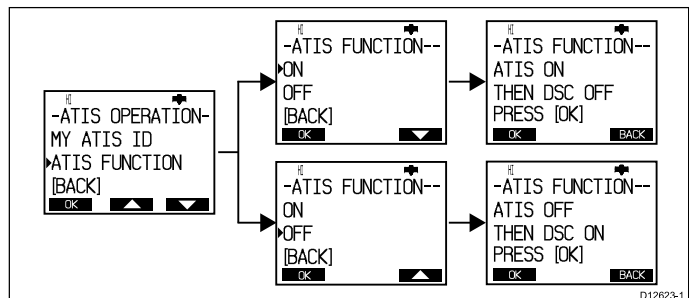

From the ATIS operation menu:

1. Select **ATIS Function**.
2. Select **ON** to enable the ATIS function, or  
The message **ATIS ON THEN DSC OFF** is displayed on-screen to warn that when ATIS is enabled then DSC functions are not available.
3. Select **OFF** to disable the ATIS function.  
The message **ATIS OFF THEN DSC ON** is displayed on-screen to warn that when ATIS is disabled then DSC functions are available again.

If no ATIS ID has been programmed then the message **PLEASE INPUT ATIS ID FIRST** is displayed.

**Note:** With the ATIS function enabled the following functions will be disabled:

- DSC functions.
- Scan functions.
- Multiple watch functions.

## 6.8 Selecting NMEA 0183 or SeaTalk<sup>ng</sup> connection

The type of connection in use must be selected (i.e. SeaTalk<sup>ng</sup> or NMEA 0183).

1. Press and release the **DSC Menu** button.  
The main menu is displayed.
2. Select **Connection**.
3. Select **Interface**.
4. Select the required connection:
  - i. Select **NMEA 2000** if you are connected to a network or device using the SeaTalk<sup>ng</sup> connector, or
  - ii. Select **NMEA 0183** if you are connected to a device using the NMEA 0183 connection.
5. For NMEA 0183 connection on a radio that has a built in AIS receiver, select the required baud rate, either **STD Speed** or **High Speed**.

## 6.9 Regional programming

The frequency band of the product can be changed and must be set to the region the product will be used in.

The regions available are:

- USA
- International
- Canada

### Changing the frequency band

Before using the product to make DSC or other calls you must set the frequency band to the relevant region.

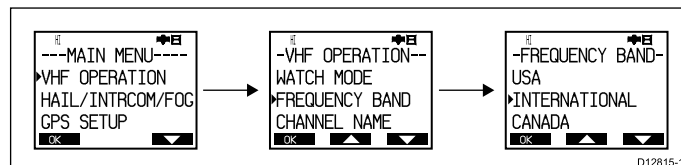

From the Main menu:

1. Select **VHF OPERATION**.
2. Select **FREQUENCY BAND**.

The list of available regions is displayed:

- USA
- International
- Canada

3. Select the relevant region.

The selected region icon will be displayed on the top left of the LCD screen.

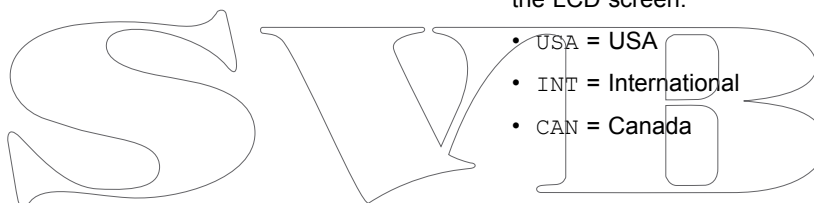

## 6.10 Adjusting the LCD backlight level

The LCD's backlight level can be adjusted by following the steps below.

1. Press and release the **MENU / DSC** button to display the main menu.
2. Select **SYSTEM CONFIG**.
3. Select **BACKLIGHT**.  
The backlight level is displayed.
4. Use the **Channel Up** and **Channel Down** buttons or the **Left Arrow** and **Right Arrow** soft buttons to adjust the backlight to the required level.
5. Select **Ok** to confirm the new backlight level.

## 6.11 Adjusting the LCD contrast

The LCD's contrast level can be adjusted by following the steps below.

1. Press and release the **MENU / DSC** button to display the main menu.
2. Select **SYSTEM CONFIG**.
3. Select **CONTRAST**.  
The contrast level is displayed.
4. Use the **Channel Up** and **Channel Down** buttons or the **Left Arrow** and **Right Arrow** soft buttons to adjust the contrast to the required level.
5. Select **Ok** to confirm the new contrast level.

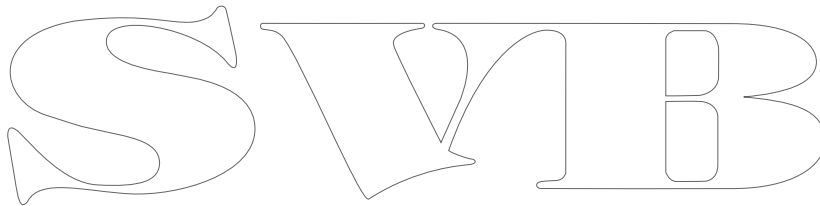
The image shows a stylized outline logo for 'SVIB'. The letters are large and have a decorative, calligraphic feel. The 'S' is on the left, followed by 'V', 'I', and 'B' on the right. The outlines are thin and black, set against a white background.

## 6.12 Changing the transmit power

You can change the power level at which the radio transmits at by following the steps below.

1. Press and release the **MENU / DSC** button to display the main menu.
2. Select **VHF OPERATION**.
3. Select **HI/LO POWER**.
4. Select the **HI/LO** soft button to switch between high and low power.

## 6.13 GPS setup

When connected to a GPS receiver over NMEA 0183 or SeaTalk<sup>ng</sup>, the radio can display relevant GPS information.

The information that can be displayed is as follows:

- latitude
- longitude
- UTC time
- COG and SOG

When GPS data is available the GPS satellite icon is displayed on-screen.

If no GPS data is available then the latitude, longitude and time can be entered manually so that it can be included in DSC distress transmissions.

Position data received from other vessels can be sent to and displayed on a connected Raymarine multifunction display.

### No GPS position

If no GPS data is available, after 10 minutes of no data the GPS icon flashes, **NO POS DATA** and **NO GPS** is displayed on screen and an audible warning is sounded.

Once the warning has been acknowledged the GPS icon will continue to flash and **NO GPS** will remain on screen. The warning will be repeated every 4 hours as long as position data is still unavailable or has not been entered manually.

If position data has been entered manually but has not been updated during the previous 4 hours the GPS icon flashes, **POS DATA OLD** is displayed on screen and an audible warning is sounded. This warning will be repeated every 4 hours until position is manually updated or GPS position data becomes available.

Where no position data is available or has not been manually updated for 23.5 hours then position data will change to '9's and time data will change to '8's.

### Entering position details manually

If no GPS receiver is present you can manually enter your position details.

From the main menu:

1. Select **GPS SETUP**.
2. Select **MANUAL POS**.

The Manual position screen requires you to input latitude, longitude and UTC time.

3. Use the **Channel Up** and **Channel Down** buttons to cycle through the available characters.
4. Select **OK** to move to the next character.
5. Use the **Right Arrow** and **Left Arrow** soft buttons to highlight the next or previous character.
6. When the relevant information has been entered select **DONE** to confirm the details.

### Selecting GPS information to display on-screen

You can select which GPS information is displayed on-screen.

From the GPS setup menu (**Main menu > GPS SETUP**):

1. Select **SETTING**.

The list of GPS information is displayed:

- **LAT/LON DISPLAY**
- **TIME DISPLAY**
- TIME OFFSET
- TIME FORMAT
- **COG/SOG**

2. Select the relevant option.
3. Select **ON** to display this information on-screen and **OFF** to hide the information

## Setting time format and offset

You can select the time format and whether an offset is applied to the time.

From the GPS setup menu (**Main menu > GPS SETUP**):

1. Select **SETTING**.
2. Select **TIME OFFSET** or **TIME FORMAT** as required.
3. Use the **Channel Up** and **Channel Down** buttons to cycle through the available values.
4. Select **OK** to confirm.

## Selecting stations to display

You can select which contacts from your phonebook you want incoming position data to be displayed on the multifunction display.

From the GPS setup menu (**Main menu > GPS SETUP**):

1. Select **NMEA OUTPUT**.
2. Select **ALL STATION** to display all incoming position data on your multifunction display, or
3. Select **LISTED STATION** to select a contact from your phonebook.

An (!) exclamation mark is placed next to the selected station.

## 6.14 Handset station priority

The handset connected to station 1 (HS1) is given priority over handsets connected to stations 2 (HS2) and 3 (HS3).

Stations 2 and 3 are given the same priority, with the first station in use given priority. When a station is making a distress call that station is given priority until the distress call has been completed.

Station 1 can interrupt station 2 and 3 and take priority by pressing the **PTT** button.

When station 1 is in use stations 2 and 3 will display **STATION 1 IN USE**. If station 2 or 3 is in use then station 1 will show the normal display and the other station will display **STATION 2 IN USE** or **STATION 3 IN USE**.

	Station 1	Station 2	Station 3
Station 1 in use		STATION1 IN USE	STATION1 IN USE
Station 2 in use			STATION2 IN USE
Station 3 in use		STATION3 IN USE	

SVIB



# Chapter 7: Digital selective calling (DSC)

## Chapter contents

- 7.1 Digital Selective Calling (DSC) on page 42
- 7.2 Distress calls on page 43
- 7.3 Urgency calls on page 45
- 7.4 Safety calls on page 46
- 7.5 Routine calls on page 46
- 7.6 Group calls on page 47
- 7.7 Position requests on page 48
- 7.8 Position tracking on page 48
- 7.9 Test calls on page 49
- 7.10 Voice mail on page 49
- 7.11 Received call logs on page 50
- 7.12 Phonebook on page 50
- 7.13 Group list on page 51
- 7.14 DSC options on page 51

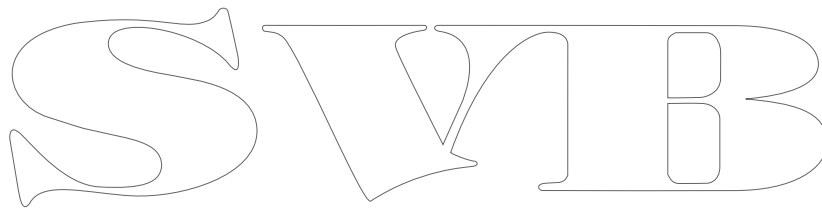

## 7.1 Digital Selective Calling (DSC)

Traditional VHF radio systems require users to listen until someone speaks, and then determine whether the call is for them. DSC ensures that calls are received by alerting or announcing the intended recipient(s) first so they are ready to listen to the subsequent message on the relevant channel.

DSC is part of the Global Maritime Distress and Safety System (GMDSS), a maritime communications system for emergency and distress messages and all types of routine communications such as ship-to-ship or ship-to-shore.

DSC is a digital signalling system, which operates on VHF channel 70. DSC calls include other data such as your vessel's identification number, purpose of the call, your position and the channel you want to speak on.

DSC calls can be divided into 4 categories and are prioritized as shown below:

1. Distress
2. Urgency
3. Safety
4. Routine

### Distress

A Distress call should only be used when there is imminent danger to a vehicle or person that requires immediate assistance.

When making a distress call the following information is transmitted to all stations within range:

- Vessel MMSI number.
- Vessel position (must be input manually if no GPS position data is available).
- Local time (must be input manually if no GPS position data is available).
- Nature of the distress (when designated).
- Transmission frequency.

The call is automatically repeated at approximately 4 minute intervals until it is acknowledged either by a coast radio station (CRS) or a vessel within radio range. Distress calls must be followed by a MAYDAY call on priority channel 16.

### Urgency

An urgency call should be used when there is danger to a vehicle or person that does not require immediate assistance.

When making an urgency call the following information is transmitted to all stations within range:

- Vessel MMSI number.
- Vessel position (must be input manually if no GPS position data is available).
- Local time (must be input manually if no GPS position data is available).
- Transmission frequency.

Once an urgency call is sent it must be followed with a PAN PAN voice message on channel 16 and include the necessary details.

### Safety

A safety call should be used when there is an important navigational warning or meteorological forecast/broadcast. Safety alerts can also be used for communications during search and rescue operations.

When making a safety call the following information is transmitted to all stations within range:

- Vessel MMSI number.
- Vessel position (must be input manually if no GPS position data is available).
- Local time (must be input manually if no GPS position data is available).
- Transmission frequency.

Once a safety call is sent it must be followed with a SECURITE voice message on channel 16 and include the necessary details.

### Routine calls

Routine calls are used for contacting other vessels, marinas, or shore stations.

Routine calls are made on channel 70 using the dedicated Maritime Mobile Service Identity (MMSI) number of the station to be contacted, selecting a VHF working channel and sending the call. Both radios automatically switch to the chosen channel for conversation.

Routine calls can also be made to groups — When groups of ships need the same information (yacht races, club rallies etc.) a special group-call identity can be used to enable restricted broadcast calls.

**Note:** To transmit precise positions, the radio must be interfaced to a GPS receiver. Otherwise, regular manual position updating is required.

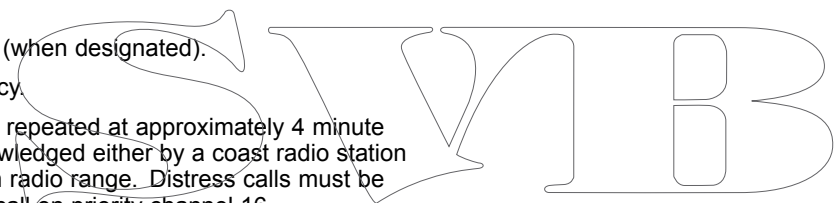

## 7.2 Distress calls

### Making a designated distress call

When making a distress call you can specify the nature of the distress and if you do not have a valid GPS position available you can specify coordinates.

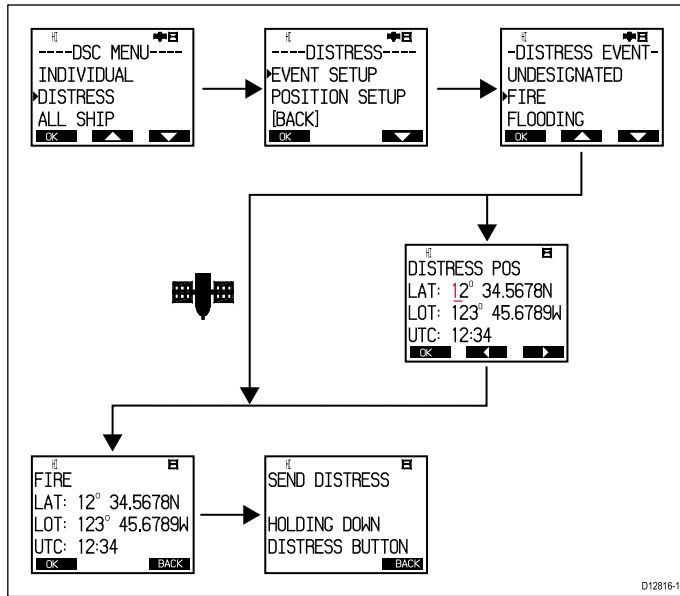

- Press and hold the Menu / DSC button for 2 seconds. The DSC menu is displayed.
- Select **DISTRESS**. The Distress event list is displayed.
- Select a distress event from the list.
  - UNDESIGNATED
  - FIRE
  - FLOODING
  - COLLISION
  - GROUNDING
  - LISTING
  - SINKING
  - ADRIFT
  - ABANDONING
  - PIRACY
  - MANOVRBOARD
- Select the relevant distress event.
  - If your radio is receiving a valid GPS position then the distress type and coordinates are displayed on-screen, otherwise you will be prompted to enter your position coordinates.
- If prompted enter your position coordinates and local time using the **Left Arrow** and **Right Arrow** soft buttons to move the cursor and the **Numeric keypad** to enter the relevant digits.
- Select **DONE**.
- Select **OK** to confirm distress details.
- Follow the steps for making a distress call to transmit the distress alert.

### Making a distress call

In an emergency you can use your product to make an automatic DSC distress call.

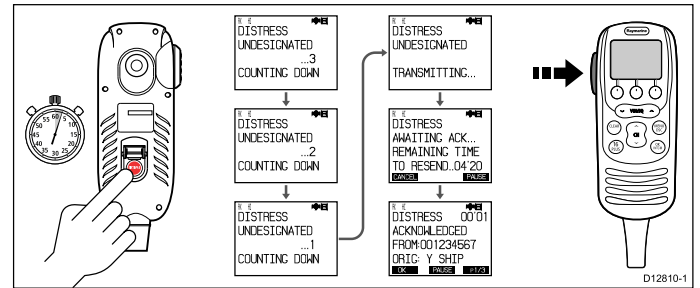

- Open the spring loaded door on the rear of the handset.
- Press and hold the **DISTRESS** button for 3 seconds.
 

Once the DISTRESS button is pressed a 3 second count down will begin, when the count down reaches zero the distress call is transmitted.
- Wait for an acknowledgement of your distress call.
 

The distress call is repeated automatically until it is acknowledged.
- Press and hold the **PTT** button.
- Slowly and clearly speak the details of the distress:
 

**MAYDAY, MAYDAY, MAYDAY**

**This is** <state name of vessel 3 times>  
**MAYDAY** <state name of vessel 1 time>  
**My position is** <state latitude and longitude, or true bearing and distance from a known point.>  
**I am** <state nature of distress e.g. sinking, on fire etc.>  
**I have** <state number of persons on board and any other information — drifting, flares fired etc.>  
**I REQUIRE IMMEDIATE ASSISTANCE OVER**
- Release the **PTT** button.

### Making a Mayday call

In an emergency you can use your product to make a Mayday call.

- Press the **16/9** or **16 PLUS** button.
- Press and hold the **PTT** button.
- Slowly and clearly speak the details of the distress:
 

**MAYDAY, MAYDAY, MAYDAY**

**This is** <state name of vessel 3 times>  
**MAYDAY** <state name of vessel 1 time>  
**My position is** <state latitude and longitude, or true bearing and distance from a known point.>  
**I am** <state nature of distress e.g. sinking, on fire etc.>  
**I have** <state number of persons on board and any other information — drifting, flares fired etc.>  
**I REQUIRE IMMEDIATE ASSISTANCE OVER**
- Release the **PTT** button.
- If an acknowledgement is not received then repeat steps 2 to 4 above.

### Cancelling a distress call before transmission

To cancel a distress call before it is transmitted follow the steps below:

- Release the **DISTRESS** button before the count down timer completes.
 

When the button is released you will be returned to normal operation.

### Cancelling a distress call after transmission

To cancel a distress call after it has been transmitted follow the steps below:

1. Press the **Cancel** soft key.  
A warning is displayed to inform the user that they are about to send a 'Distress cancel call'.
2. Press the **Send** soft key.  
The 'Distress cancel call' is sent.
3. Press the **OK** soft key.
4. Make a broadcast to all stations giving your vessel's name, call sign and MMSI number and cancel the false distress alert  
Example: "All, Stations, All Stations, All Stations. This is <NAME>, <CALL SIGN>, <MMSI ID>, <POSITION>. Cancel my distress alert of <DATE>, <TIME>, <NAME>, <CALL SIGN>".
5. Repeat the broadcast described in step 4.
6. Press **End** to revert back to normal operation.

## Receiving a distress call

It is expected that only a Coast Radio Station (CRS) will acknowledge DSC distress calls and will act as the coordinator for the rescue operation.

When a distress call is received an alarm is sounded at full volume and the LCD displays information pages relating to the distress. This includes:

- MMSI or Name of vessel (Name of distressed vessel is only displayed if it is a contact saved in the phonebook).
- Nature of distress.
- Latitude and longitude of distressed vessel.
- Time of distress call.

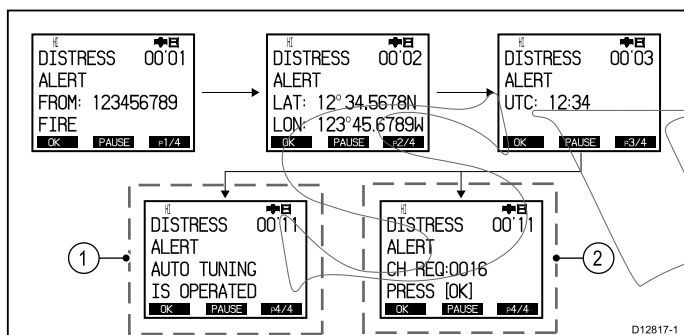

1. Sequence when auto channel change is turned on.
2. Sequence when auto channel change is turned off.

If the Auto channel change function is enabled 10 seconds after receipt of a distress call the radio will automatically re-tune to channel 16. Otherwise the user is prompted to change channel manually.

The details of the distress call are recorded in the distress log and the envelope icon will flash on-screen to let you know a message has been received. When connected to a Raymarine multifunction display the position data from a distress call can also be display in the chart application.

When the received distress call is acknowledged by the CRS or another station then the radio will resume normal operation.

## Accepting a distress call

To accept the distress call follow the steps below.

With an active distress call displayed.

1. With Auto channel change turned on – Select **OK**.  
The alarm is muted, the envelope icon is turned off and the radio will switch to channel 16.
2. With Auto channel change turned off – Select **OK** to mute the alarm and turn off the envelope icon. Select **OK** again to accept the channel change to channel 16.

## Muting a distress call

You can ignore a distress call by muting the alarm and cancelling the distress call screen.

With an active distress call displayed.

1. Press the **Clear** button to mute the alarm.
2. Press the **Clear** button again to cancel the distress call screen.  
The envelope icon will be turned off and normal operation is resumed.

## Acknowledging a distress call

Distress calls must only be acknowledged if the call continues without acknowledgement from a CRS, you are close enough to the distressed vessel to be of assistance and are prepared to relay the distress to a CRS by any means possible. Class D DSC radios are forbidden from automatically acknowledging distress calls. Acknowledgement must only be made by voice message on channel 16.

After receiving a distress call that has gone unanswered:

1. Switch to channel 16 to listen for the distress voice message.
2. Wait for the CRS to acknowledge the call.
3. If the distress call is not acknowledged by another station then acknowledge the call as follows:

### MAYDAY

(MMSI of the vessel in distress)

**Name of vessel in distress** <repeated 3 times>

**Call sign of the vessel in distress**

**This is** <MMSI of your vessel>, <name of your vessel repeated 3 times> <call sign of your vessel>

### RECEIVED MAYDAY

4. You **MUST** then notify the shore authorities by any means possible to relay the distress call.

## Manually relaying a distress call

A distress relay should only be sent if: the person or vehicle in distress is unable to transmit the distress call itself, for example red flares sighted at night or the person or vehicle in distress is out of range of a CRS and you have already acknowledged the distress by voice message. You can also relay a received distress relay alert manually if it goes unanswered.

1. Switch to channel 16
2. Slowly and clearly speak the details of the distress:

### MAYDAY RELAY, MAYDAY RELAY, MAYDAY RELAY

**This is** <MMSI of your vessel, name of your vessel repeated 3 times and your call sign>

**Received the following MAYDAY from** <MMSI of vessel in distress, name of vessel in distress, call sign of vessel in distress>

### Message begins

**Message received from vessel in distress or details of the distress**

**Message ends**

**OVER**

## Distress relays sent by other stations

When a Coast Station or another vessel, has received, and acknowledged a DSC distress alert it may transmit a distress alert relay to other vessels in the immediate area.

Distress relays sent from other stations can be received by the radio.

The radio cannot re-send a distress relay automatically. If required you can relay a distress relay message manually.

If a distress relay is sent specifically to the radio then it can be acknowledged, otherwise acknowledgement is not required.

## Acknowledging a distress relay sent to your vessel

If a distress relay is specifically sent to your vessel this will be because the sender deems you to be in a position to assist in the rescue. The distress relay information is displayed on-screen.

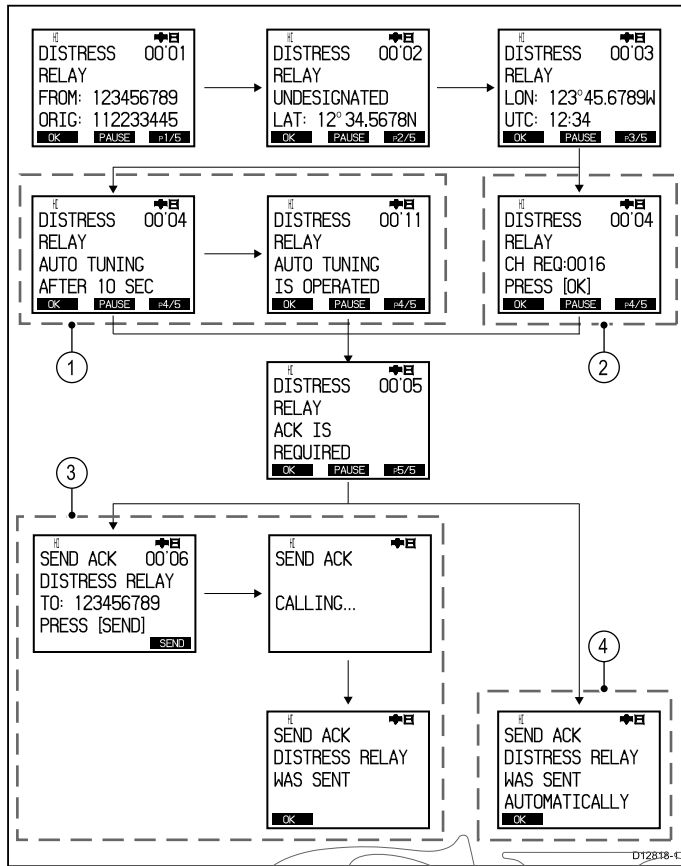

1. Sequence when auto channel change is turned on.
2. Sequence when auto channel change is turned off.
3. Sequence when individual reply is turned off.
4. Sequence when individual reply is turned on.

When a distress relay is received:

1. Select the **RIGHT** soft button to cycle through the information pages.
2. If the distress relay was sent individually to you select **OK** at any time to acknowledge the distress relay.
3. Ensure the radio is tuned to channel 16.

**Note:** Distress relay calls can only be acknowledged automatically when sent individually to you.

## 7.3 Urgency calls

### Making an urgency call

An urgency call should be used when there is danger to a vehicle or person that does not require immediate assistance. Urgency calls are transmitted to all stations.

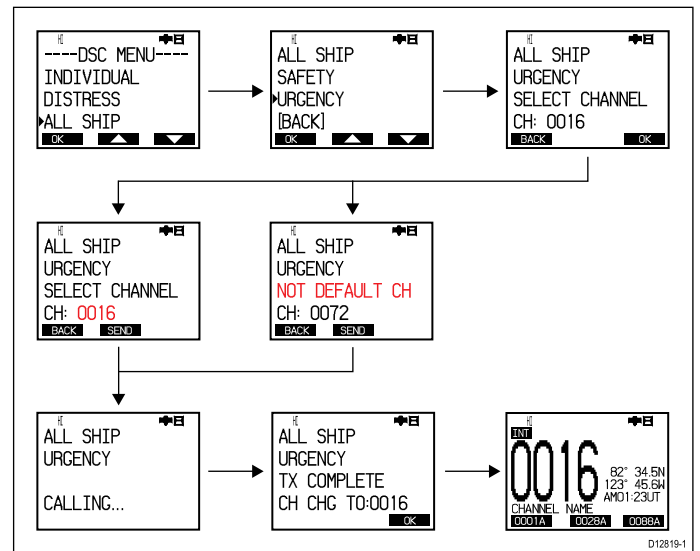

From the DSC menu:

1. Select **ALL SHIP**.
2. Select **URGENCY**.
3. If required use the **Channel Up** and **Channel Down** buttons to select the relevant channel for subsequent communication. The default channel is 16.
4. Select **OK** to confirm the channel.
5. Select **SEND** to send the DSC urgency announcement.
6. Wait for the **TX COMPLETE** message to be displayed on-screen and then select **OK**. The channel is now changed to the chosen channel.
7. Press and hold the **PTT** button and speak the following message:

**PAN PAN, PAN PAN, PAN PAN**

**ALL STATIONS, ALL STATIONS, ALL STATIONS**

**This is** <MMSI of your vessel, name of your vessel repeated 3 times, call sign of your vessel>

**Position** <Your vessel's position>

**Reason for call** <State the reason for the call and include all information which will assist in the rescue.

**OVER**

### Receiving an urgency call

If you receive an urgency call from another station the details are displayed on-screen.

When an urgency call is received:

1. Press the **RIGHT** soft button to cycle through the information pages.
2. Select **OK** at any time to accept the urgency call.

If auto channel change is turned on then the channel will automatically change after 10 seconds.

The radio is re-tuned to channel 16.

3. Listen on channel 16 for the urgency message.

## 7.4 Safety calls

### Making a safety call

A safety call should be used when there is an important navigational warning or meteorological forecast/broadcast. Safety alerts can also be used for communications during search and rescue operations.

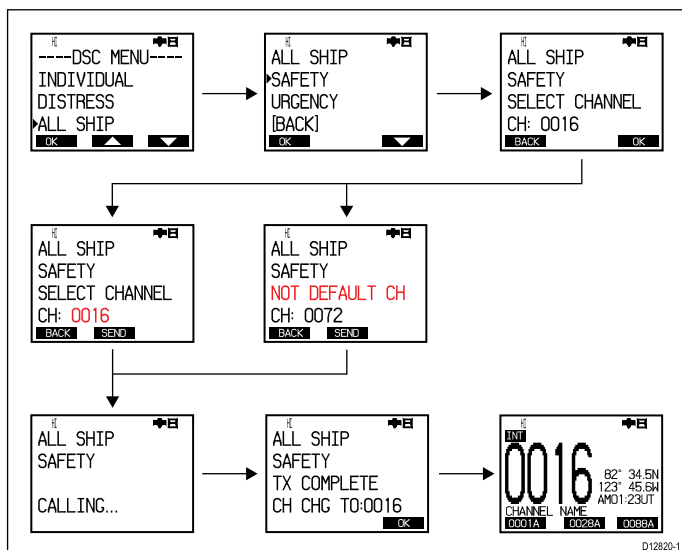

From the DSC menu:

1. Select **ALL SHIP**.
2. Select **SAFETY**.
3. If required use the **Channel Up** and **Channel Down** buttons to select the relevant channel for subsequent communication.

The default channel is 16.

4. Select **OK** to confirm the channel.
5. Select **SEND** to send the DSC safety call.
6. Wait for the **TX COMPLETE** message to be displayed on-screen and then select **OK**.

The channel is now changed to the chosen channel.

7. Press and hold the **PTT** button and speak the following message:

**SECURITE, SECURITE, SECURITE**

**ALL STATIONS, ALL STATIONS, ALL STATIONS**

**This is** <MMSI of your vessel, name of your vessel repeated 3 times, call sign of your vessel>

**Position** <Your vessel's position>

**Reason for call** <state the reason for the safety call>

**OUT**

### Receiving a safety call

If you receive a safety call from another station the details are displayed on-screen.

When a safety call is received:

1. Press the **RIGHT** soft button to cycle through the information pages.
2. Select **OK** at any time to accept the safety call.

If auto channel change is turned on then the channel will automatically change after 10 seconds.

The radio is re-tuned to channel 16.

3. Listen on channel 16 for the safety message.

## 7.5 Routine calls

Individual calls can be made to ships and coast station contact saved in your phonebook or to any station by manually entering the stations MMSI number.

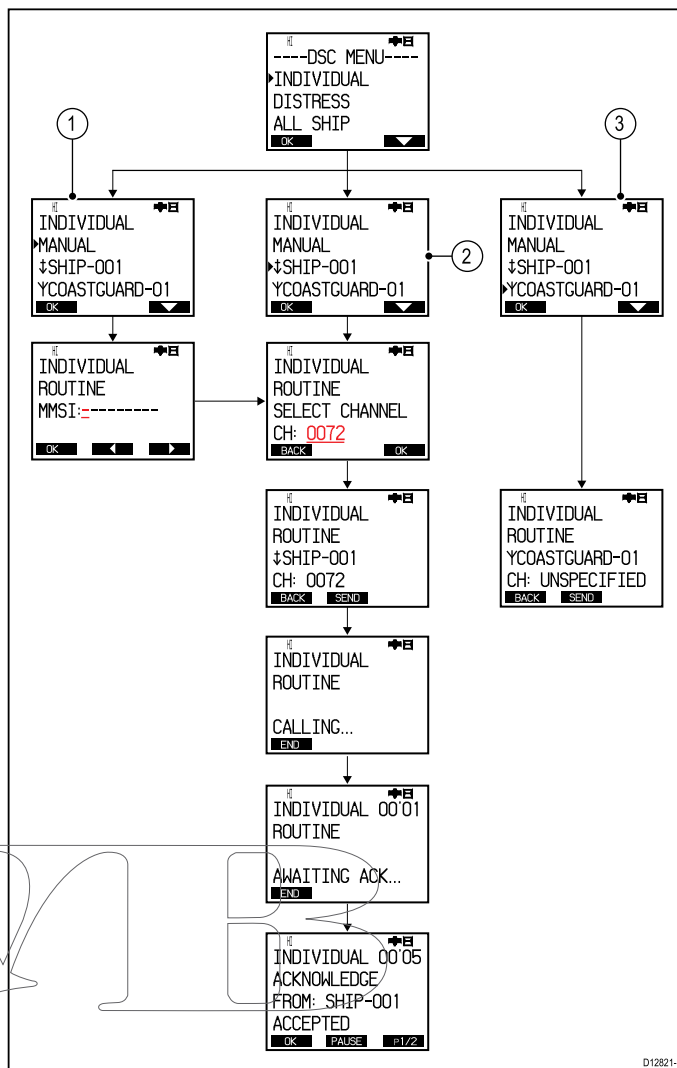

1. Individual routine call using manual MMSI entry.
2. Individual routine call to a vessel saved as a contact.
3. Individual routine call to a coast station saved as a contact.

Refer to the *Phonebook* section for details on adding contacts to your phonebook.

**Note:** When calling a coast station there is no need to select a channel for communication.

If a call cannot be accepted then a reason code will be displayed on-screen.

100	NO REASON	No reason given
101	CONGESTION	Congestion at maritime switching centre
102	BUSY	Station Busy
103	QUEUE	Queue indication
104	BARRED	Station barred
105	NO OPERATOR	No operator available
106	UNAVAILABLE	Operator temporarily unavailable
107	DISABLE	Equipment disabled
108	UNABLE CH	Unable to use proposed channel
109	UNABLE MODE	Unable to use proposed mode

## Making a routine DSC call

You can use your product to make a routine DSC call to contact saved in the phonebook.

1. Press and hold the **Menu DSC** button for 3 seconds.  
The DSC menu is displayed.
2. Select **Individual**.  
The Manual option and the phonebook list is displayed.
3. Select a phonebook entry to make a DSC call to that contact, or
4. Select **MANUAL** to manually enter an MMSI number.
5. Use the **Channel Up** and **Channel Down** buttons to select a channel to transmit on.
6. Select **OK**.
7. Select **SEND**.

The radio now waits for an acknowledgement to be received.

8. If an acknowledgement is received, press and hold the **PTT** button.
9. Speak your message.
10. Release the PTT button when you have completed your message.

## Receiving a routine individual call

When you receive an individual routine call the details are displayed on-screen.

When an individual routine call is received.

1. Press the **RIGHT** soft button to cycle through the information pages.
2. If you want to accept the call select **OK** at any time.

If auto channel change is turned on the radio will automatically change to the request channel in 10 seconds.

3. Select **ACCEPT** to accept the call, or
4. Select **NOT ACCEPT** to reject the call.
  - i. If you do not accept the call you can select a reason from the list by selecting **OP**:
    - **NO REASON**
    - **CONGESTION**
    - **BUSY**
    - **QUEUE**
    - **BARRED**
    - **NO OPERATOR**
    - **UNAVAILABLE**
    - **DISABLE**
    - **UNABLE CH**
    - **UNABLE MODE**
  - ii. Select **OK** to confirm the reason.
5. Select **SEND** to send the acceptance or rejection of the call.

Confirmation of the acceptance or rejection of the call is displayed on-screen. If you have accepted the call then the radio will re-tune to the requested channel.

## 7.6 Group calls

Routine group calls can be made to groups of vessels sharing the same Group MMSI numbers.

Routine group calls are made by selecting a group from the Group menu, group calls are only received by stations sharing the selected group MMSI number.

Refer to the *Group list* section for details on adding groups to your radio.

### Making a group routine call

To make a routine call to a group of stations use the group menu.

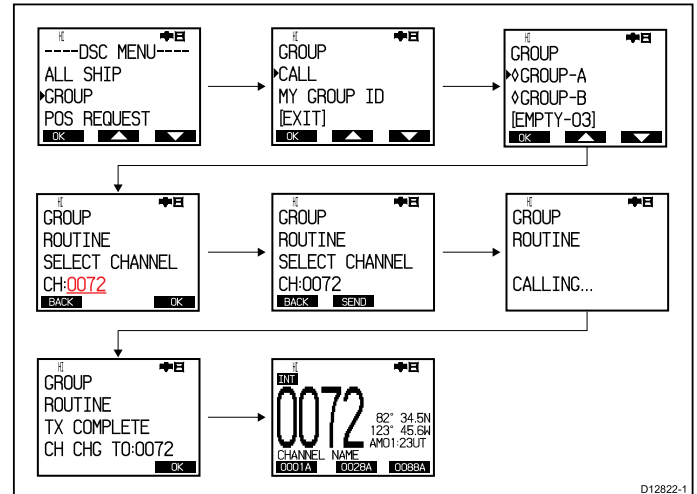

1. Press and hold the **DSC Menu** button for 3 seconds.  
The DSC menu is displayed.
2. Select **GROUP**.
3. Select **CALL**.  
The group list is displayed.
4. Select a group you want to make a call to.
5. Use the **Channel Up** and **Channel Down** buttons to select a channel you want to use for the communication.
6. Select **OK**.
7. Select **SEND**.  
The radio now will now call the selected group.
8. When **TX COMPLETE** is displayed on-screen select **OK**.
9. Press and hold the **PTT** button.
10. Speak your message.
11. Release the **PTT** button when you have completed your message.

### Receiving a group call

If you receive a group call the details are displayed on-screen.

1. Press the **RIGHT** soft button to cycle through the information pages.
2. Select **OK** at any time to accept the group call, or
3. Select **CANCEL** reject the call and resume normal operation.
4. If the caller has requested an acknowledgement then select **SEND** to send the acknowledgement.

With auto channel change turned on the radio will automatically change to the requested channel after 10 seconds, otherwise you will be request to confirm the change of channel.

## 7.7 Position requests

The radio can request position information from any station capable of responding to the request.

Position requests can be sent to any contact stored in the phone book or by manually inputting the MMSI number of the station.

When connected to a Raymarine multifunction display the position data from the request can also be display in the chart application.

### Making a position request

You can make a position request following the steps below.

From the DSC menu.

1. Select **POS REQUEST**.
2. You can select a contact from your phonebook directly from the POS REQUEST menu, or
3. To request the position of a station that you know the MMSI number of select **MANUAL**.
4. Use the **Channel Up** and **Channel Down** buttons to select the required numbers.
5. When you have completed the MMSI number select **OK** to confirm.
6. Select **SEND** to send the position request.
7. Wait for an acknowledgement.
8. When the acknowledgement is received use the **RIGHT** soft button to cycle through the received position report pages.

### Responding to a position request

If you receive a position request from another station follow the steps below.

When a position request is received:

1. Select the **RIGHT** soft button to cycle through the available information pages.
2. Select **OK**.  
If the position reply option is set to auto the position report is sent automatically.
3. If the position reply is set to manual then select **SEND** to send the position report.
4. Select **OK** to resume normal operation.

## 7.8 Position tracking

The position tracking function enables regular position requests to be sent to selected target stations. The position data will be available on a Raymarine multifunction display connected over NMEA 0183 or SeaTalk<sup>ng</sup>.

Up to 3 phonebook contacts can be added to the position tracking selection menu. The selected contacts will then be available to be tracked. The position requests are sent out every 5 minutes and where more than 1 vessel is being tracked the position requests will alternate between selected stations.

Time	Tracking started	5 minutes	10 minutes	15 minutes
Tracked station	Vessel 1	Vessel 2	Vessel 3	Vessel 1

### Setting up regular position tracking

To enable position tracking you need to track selected stations.

From the DSC menu:

1. Select **POS TRACKING**.
2. Select **SELECT STATION**.
3. Select an empty slot.  
The phonebook is displayed.
4. Select the relevant contact from the phonebook.
5. Repeat steps 3 and 4 for up to 3 contacts.  
The selected contacts are now available to be tracked.
6. Select **BACK** to go back to the position tracking menu.
7. Select **TARGET STATION**.  
A list of the contacts selected in steps 3 and 4 is displayed.
8. Select up to 3 contacts that you want to track.
9. From the Position Tracking menu select **START TRACKING**.  
The selected vessels will now be tracked.
10. Select **END** at any time to cancel the position tracking and return to normal operation.



## 7.9 Test calls

A Test Call feature is available for the purposes of testing your DSC VHF radio for correct operation.

There are 2 types of test call:

- Test call to the US Coast Guard automated response test call service (MMSI: **003669999**). This type of test call will receive an automated response (acknowledgement).
- Test call to another vessel that has a radio that supports the test call feature. If the receiving radio is a Raymarine radio, this type of test call requires a manual response (acknowledgement) from the call recipient. Some third-party radios are capable of providing an automated response to test calls.

For radios that do NOT support the test call feature, correct radio operation can be tested by making an individual call on channel 70 to another DSC VHF radio.

Raymarine recommends that once you've successfully placed a test call you add the test call MMSI to your radio's phonebook for easy retrieval for future test calls. For information on how to add an MMSI to your radio's phonebook, refer to the radio's user documentation.

**Note:** Individual calls (that is, NOT a test call) to the US Coast Guard 003669999 MMSI will NOT receive an automated response.

**Note:** The US Coast Guard automated response test call service is only available in the United States and its coastal waters.

## Making a test call

With the radio set to any channel:

1. Select and hold the **DSC Menu** button.  
The DSC menu is displayed.
2. Select **TEST CALL**.
3. Select **MANUAL** to enter the MMSI number. Alternatively, a contact can be selected from the radio's phonebook.
4. Enter the Test Call MMSI (for example, **003669999** for US Coast Guard automated response test call service).
5. Select **OK**.
6. Select **SEND** to initiate the test call.
7. If you called the US Coast Guard automated response test call MMSI, wait for an acknowledgement. If you made a test call to another vessel with a test call capable radio, a response is required from the receiving radio.  
When an acknowledgement is received, an audible alarm is sounded and the message (envelope) icon flashes.
8. Select any key to mute the alarm.
9. Select **OK** to exit the test call and resume normal operation.

## Receiving a test call

Your radio will automatically acknowledge received test call from other stations

When a test call is received a notification is displayed on-screen to alert you that a test call has been received and automatically acknowledged.

## 7.10 Voice mail

The radio includes a voice mail feature. The voice mail feature enables automated transmission of a pre-recorded message.

A voice message up to 15 seconds long can be recorded, stored on the radio and then sent to a contact stored in the radio's phonebook. If the contact's vessel is in DSC range the message will be transmitted on the current working channel once an acknowledgement is received. If the contact's vessel is not in DSC range then the voice mail call is repeated every 5 minutes for up to 1 hour or until the call is acknowledged.

**Important:** The voice mail feature should only be used with an operator manning the station. Do NOT operate the voice mail feature with the station unattended, doing so could cause undue interference to other users and be in breach of the terms of your VHF radio license.

Receiving a voice mail follows the same steps as receiving a routine individual call.

## Recording a voice mail message

You can record a voice message by following the steps below. Recording a voice mail message will overwrite the existing message.

From the DSC menu.

1. Select **VOICE MAIL**.
2. Select **RECORDER**.
3. Press and hold the **PTT** button.  
Recording will start.
4. Speak your message and release the **PTT** button when your message is complete.  
The message is saved.
5. Select **PLAY** to listen to your recording.

## Deleting a voice mail message

If you want to delete your voice mail message follow the steps below.

From the DSC menu.

1. Select **VOICE MAIL**.
2. Select **RECORDER**.
3. Select **DELETE**.
4. Select **DELETE** again to confirm.  
The voice mail is deleted.

## Sending a voice mail message

To send the voice mail message follow the steps below.

From the DSC menu.

1. Select **VOICE MAIL**.
2. Select **START VOICE MAIL**  
If no message has been recorded then the **MESSAGE IS NOT RECORDED** notification is displayed.
3. Select the contact from the list.
4. Select the channel you want to send the voice mail on.
5. Select **OK**.
6. Select **SEND**.

## 7.11 Received call logs

All DSC calls received are logged in received call logs.

The following call types are recorded in the received call logs:

- distress
- distress relay
- distress acknowledgements
- sent position requests
- received position requests
- group calls
- all ship calls
- individual routine calls

The details below are recorded for each call:

- station ID
- type of call
- date of call
- latitude and longitude (if sent with the call)
- nature of distress (specified distress calls only)

If the call was received from a contact in the phonebook then the contact name is displayed, otherwise the MMSI number is displayed.

### Accessing the received call logs

Follow the steps below to access the received call logs.

From the DSC menu:

1. Select **RECEIVED CALLS**.

The following logs are available:

- unread log
  - distress log
  - call log
  - position log
2. Select the log you want to view.  
A list of logged calls is displayed.
  3. Select a call to view details.
    - i. Select **CALL BACK** to return the call.
    - ii. Select **DELETE** to remove the entry from the log.
    - iii. Select **SAVE** to save the sender of the call to your phonebook.
    - iv. Select **ACK SEND** to send an acknowledgement to the sender.

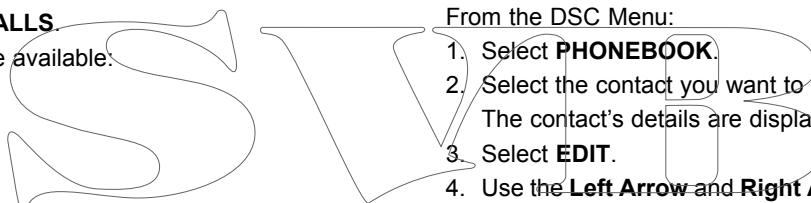

## 7.12 Phonebook

The phonebook can be used to save up to 200 contacts.

You can add, edit and delete contacts stored in the phonebook.

### Adding an entry

You can save contacts in the phonebook by entering their MMSI and assigning a name to the contact.

From the DSC menu:

1. Select **PHONEBOOK**.
2. Select **NEW**.
3. To enter the MMSI number use the **Channel Up** and **Channel Down** buttons to select the number you want then select **OK** to confirm and move to the next digit.

When all 9 digits of the MMSI have been entered you can assign a name for the group.

4. To enter a name for the contact use the **Channel Up** and **Channel Down** buttons to select the characters you want then select **OK** to confirm and move to the next character.

The maximum length of contact names is 10 characters.

5. When you have entered a name for the contact select **OK** to save the entry in your phonebook.

You will be returned to the Phonebook.

6. You can use the **Left Arrow** and **Right Arrow** soft buttons at any time to move forward or backwards to correct any errors.

### Editing an entry

You can edit the MMSI number and name of contacts in your phonebook.

From the DSC Menu:

1. Select **PHONEBOOK**.
2. Select the contact you want to edit.  
The contact's details are displayed.
3. Select **EDIT**.
4. Use the **Left Arrow** and **Right Arrow** soft buttons to highlight the character you want to change.
5. Use the **Channel Up** and **Channel Down** buttons to select the characters you want then select **OK** to confirm and move to the next character.
6. When you have completed your changes select **OK** to save the changes.

You are returned to your phonebook.

### Deleting an entry

You can delete contacts stored in your phonebook.

From the DSC menu:

1. Select **PHONEBOOK**.
2. Select the contact you want to delete.
3. Select **DELETE**.
4. Select **DELETE** again to confirm and delete the contact.

The phonebook is displayed and the contact is now deleted.

## 7.13 Group list

Groups can be created to the MY GROUP ID list to enable group calling.

Existing groups can be edited and deleted as required.

### Adding a Group MMSI

To make a group routine call you need to add a group MMSI number to your group list. You can store up to 20 group MMSI numbers on your radio.

From the DSC Menu:

1. Select **MY GROUP ID**.
2. Select an empty entry e.g. [EMPTY 01].
3. Use the **Channel Up** and **Channel Down** buttons to select the number you want then select **OK** to confirm and move to the next digit.

When all 9 digits of the MMSI have been entered you can assign a name for the group.

4. Use the **Channel Up** and **Channel Down** buttons to select the characters you want then select **OK** to confirm and move to the next character.

The maximum length of group names is 10 characters.

5. When you have entered a name for the group select **OK** to save the entry in your group list.  
You will be returned to the group list.
6. You can use the **Left Arrow** and **Right Arrow** soft buttons at any time to move forward or backwards to correct any errors.

### Editing a group

You can edit the MMSI number and name of groups stored on your radio.

From the DSC Menu:

1. Select **MY GROUP ID**.
2. Select the Group you want to edit.  
The group's details are displayed.
3. Select **EDIT**.
4. Use the **Left Arrow** and **Right Arrow** soft buttons to highlight the character you want to change.
5. Use the **Channel Up** and **Channel Down** buttons to select the characters you want then select **OK** to confirm and move to the next character.
6. When you have completed your changes select **OK** to save the changes.

You are returned to your group list.

### Deleting a group

You can delete group MMSI details.

From the DSC menu:

1. Select **MY GROUP ID**.
2. Select the group you want to delete.
3. Select **DELETE**.
4. Select **DELETE** again to confirm and delete the group.

The group list is displayed and the group is now deleted.

## 7.14 DSC options

DSC options can be set from the DSC options menu.

<b>AUTO CH CHANGE</b>	When automatic channel change is turned on the radio will automatically re-tune after 10 seconds to the requested channel when DSC calls are received. The automatic channel changing blocked icon  is displayed when the setting is switched off.	<ul style="list-style-type: none"> <li>• ON</li> <li>• OFF (default)</li> </ul>
<b>INDIVIDUAL REPLY</b>	When individual reply is set to auto the radio will automatically acknowledge individual calls and distress relay calls when received.	<ul style="list-style-type: none"> <li>• MANUAL (default)</li> <li>• AUTO</li> </ul>
<b>AUTO END</b>	When set to a time interval the radio will automatically end calls sent or received which have gone unacknowledged for the specified time interval. The timer can be set at 10 second increments from 10 seconds up to 15 minutes. The default time interval is 30 seconds.	<ul style="list-style-type: none"> <li>• 30 SECONDS</li> <li>• SET TIMER</li> <li>• DISABLE</li> </ul>
	<b>Note:</b> This does not apply to distress calls.	
<b>POSITION REPLY</b>	With position reply set to auto the radio will automatically send out position details when a position request is received.	<ul style="list-style-type: none"> <li>• MANUAL (default)</li> <li>• AUTO</li> </ul>

### Accessing the DSC options menu

To access the DSC options menu follow the steps below:

1. Press and hold the **DSC Menu** button.  
The DSC menu is displayed.
2. Select **DSC OPTIONS**.  
The DSC options menu is displayed.

SWIB

# Chapter 8: VHF operations

## Chapter contents

- [8.1 Scan mode on page 54](#)
- [8.2 Watch modes on page 54](#)
- [8.3 Priority channels on page 55](#)
- [8.4 Favorite channels on page 55](#)
- [8.5 Sensitivity on page 56](#)
- [8.6 Private channels on page 56](#)
- [8.7 Automatic Transmitter Identification System \(ATIS\) and Marcom-C mode on page 57](#)
- [8.8 AIS on page 58](#)
- [8.9 Voice recorder on page 58](#)
- [8.10 System configuration on page 59](#)

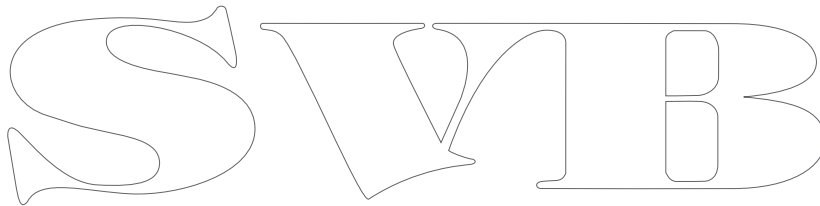

## 8.1 Scan mode

Scan mode enables automatic searching for channels that are currently broadcasting.

Scan mode will search channels and stop when it finds a channel that is broadcasting. If the broadcast stops or is lost for more than 5 seconds then the scan will resume.

Channels can be temporarily removed from an active scan, and the direction of scan can also be changed. When the scan reaches the last channel in the band the scan cycle is repeated.

The following scans options are available:

- **ALL SCAN** — All channels in the frequency band the radio is set to are scanned in sequence.
- **ALL SCAN + 16** — All channels in the frequency band the radio is set to are scanned, after each channel is scanned priority channel 16 is scanned.
- **SAVED SCAN** — Only channels saved to the radio's memory are scanned in sequence.
- **SAVED SCAN + 16** — Only channels saved to the radio's memory are scanned, after each channel is scanned priority channel 16 is scanned.

**Note:** On the Ray260 and Ray260 AIS, if the weather alert function is activated the weather alert channel is included in the scan.

## Performing a scan

Scan mode is started from the main menu.

From the VHF operation menu (**Main menu > VHF OPERATION**):

1. Select **SCAN MODE**.
2. Select either:
  - **ALL SCAN**
  - **ALL SCAN + 16**
  - **SAVED SCAN**
  - **SAVED SCAN + 16**

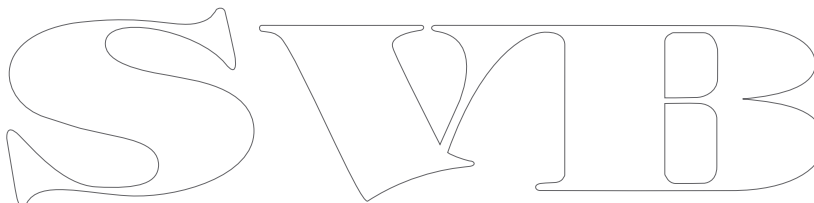

Once selected the scan will start.

3. You can exclude a channel from the current scan by selecting **XCLUDE** when the scan stops on that channel.
4. You can stop the current scan at any time by selecting **END**.

## Saving a channel

You can add channels to the radio's memory so that they are included in the scan save and scan save +16 scan modes.

From the VHF operation menu (**Main menu > VHF OPERATION**):

1. Select **SAVE CHANNEL**.
2. Use the **Channel Up** and **Channel Down** buttons to select the relevant channel.
3. Select **SAVE** to save the channel.
4. To remove a saved channel select **CLEAR**.

The **SAVED** icon appears on-screen when you are tuned to a saved channel.

## 8.2 Watch modes

The watch modes monitor priority channels and the currently selected channel.

There are 2 type of watch mode; Dual watch and Tri watch.

- Dual watch mode monitors priority channel 16 and the currently selected channel.
- Tri watch mode monitors priority channel 16, the second priority channel and the currently selected channel.

When the radio detects a transmission the watch mode is suspended until the transmission ends then the watch mode will recommence.

## Using watch modes

From the VHF operation menu (**Main menu > VHF OPERATION**):

1. Select **WATCH MODE**.
2. Select either **DUAL WATCH** or **TRI WATCH** to start the watch mode.
3. Select **END** at any time to stop the watch mode and resume normal operation.

## 8.3 Priority channels

Channel 16 is the dedicated priority channel.

The default secondary priority channel is channel 09, however this can be changed if required.

### Switching between priority channels

1. Press the **Priority** button to switch between the priority channels and the last used channel.

### Setting a second priority channel

You can select which channel you want to use as the second priority channel.

From the VHF operation menu (**Main menu > VHF OPERATION**):

1. Select **2ND PRIORITY**.
2. Use the **Channel Up** and **Channel Down** buttons to select the required channel.
3. Select **OK** to confirm.

## 8.4 Favorite channels

Favorite channels can be saved to memory and assigned to the soft buttons during normal operation.

A total of 9 channels can be saved as favorites, Favorite channels are assigned to 1 of 3 banks of favorite channels. A bank of favorite channels is assigned to the soft buttons. The bank that is displayed can be changed and channels can be added and removed as required.

The LCD displays which bank of favorites has been selected i.e. **FAV 1**, **FAV 2**, or **FAV 3**.

### Adding favorite channels

Follow the steps below to add channels to the 3 favorite channel banks.

From the VHF operation menu (**Main menu > VHF OPERATION**):

1. Select **FAVORITE CH**.
2. Select either **FAV CH BANK-1**, **FAV CH BANK-2**, or **FAV CH BANK-3**.
3. Select **EDIT BANK**.
4. Use the **Up Arrow** and **Down Arrow** soft buttons to select either **LEFT**, **CENTER**, or **RIGHT** as required.
5. Use the **Channel Up** and **Channel Down** buttons to change the assigned channel.
6. Select **OK** to confirm channel assignment.
7. Repeat the steps above for each favorite bank.

### Selecting a favorite channel bank

You can change which favorite channel bank is assigned to the soft buttons.

From the Favorite channel menu (**Main menu > VHF OPERATION > FAVORITE CH**):

1. Select either **FAV CH BANK-1**, **FAV CH BANK-2**, or **FAV CH BANK-3**.
2. Select **SELECT BANK**.
3. Select **OK** to confirm.

The chosen bank is now assigned to the soft buttons and are displayed during normal operation.

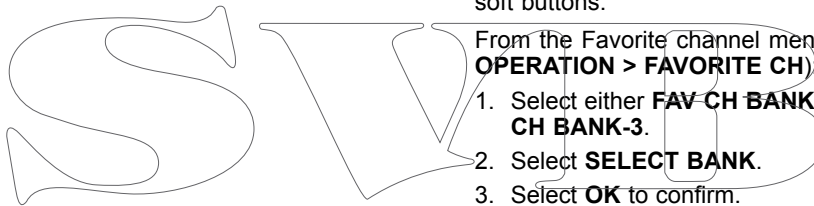

## 8.5 Sensitivity

The sensitivity level of the radio can be set to local mode or distant mode.

Local mode decreases the receiver sensitivity in high traffic areas to decrease unwanted reception. When in local mode **LOCAL** is displayed on-screen.

Distant mode sets the receiver sensitivity to full. When in distant mode the **LOCAL** icon is removed from the display.

### Switching sensitivity modes

You can switch between local and distant modes at any time.

From the VHF operation menu (**Main menu > VHF OPERATION**):

1. Select **SENSITIVITY**.
2. Select the **D/L** soft button.

Selecting the D/L soft button switches between local and distant modes. In local mode **LOCAL** is displayed on-screen

3. Select **BACK** or press the **Clear** button to return to the previous menu.

## 8.6 Private channels

The radio may be able to receive additional private channels depending on the country it is used in and whether the appropriate licenses are held.

A list of private channel can be found in *Appendix 1*.

**Note:** Private channels are only available on the Ray260E and Ray260E AIS.

### Selecting private channels

You can select the set of private channels you want to use.

From the VHF operation menu (**Main menu > VHF OPERATION**):

1. Select **PRIVATE CH.**

The list of private channel sets is displayed:

- **NONE**
- **BELGIUM**
- **DENMARK PLEA.**
- **DENMARK FISH.**
- **FINLAND PLEA.**
- **FINLAND FISH.**
- **HOLLAND (Netherlands)**
- **NORWAY PLEA.**
- **NORWAY FISH.**
- **SWEDEN PLEA.**
- **SWEDEN FISH.**
- **UK**

2. Select the required private channel set.

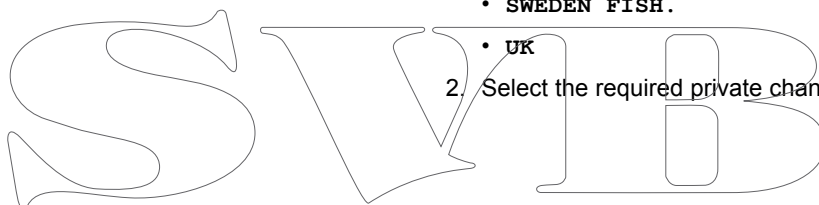



## 8.7 Automatic Transmitter Identification System (ATIS) and Marcom-C mode

ATIS is a European system used on some inland waterways.

VHF radios operating in an ATIS region must be programmed with a unique ATIS number; this can be obtained from the relevant licensing authority. The ATIS number is attached as a digital signal at the end of each transmission and identifies you to the relevant authorities who monitor the system.

When operating in ATIS mode, some of the products features are not available:

- Use of DSC is not permitted in ATIS regions. You will be unable to make DSC distress and other types of digital selective call.
- Dual / Tri Watch operation is not permitted in ATIS regions. You will be unable to use these features.
- Channel scanning is not permitted in ATIS regions. You will be unable to use the scan features.
- ATIS regulations restrict the transmit power to 1 watt for the following channels: 6, 8, 10, 11, 12, 13, 14, 71, 72, 74 and 77. You will be unable to change the power on affected channels.

You can enable or disable ATIS using the menus (except on Marcom-C configured units).

### Marcom-C mode

Marcom-C mode is a restricted Ray260 configuration for VHF operators with a Marcom-C license. This is applicable to radios operated exclusively in European inland waterways using the ATIS system.

A Marcom-C VHF radio has the ATIS permanently enabled. You will not be able to disable ATIS operation. Marcom-C operation is set by the dealer at point of sale. If you wish to enable or disable Marcom-C mode, you must contact your Raymarine dealer.

For further information please contact Raymarine technical support.

**Note:** With the ATIS function enabled the following functions will be disabled:

- DSC functions.
- Scan functions.
- Multiple watch functions.

### Enabling / Disabling the ATIS function

With the ATIS ID programmed you can now enable or disable the ATIS function as required by following the steps below.

**Note:** If your radio has been configured to use Marcom-C mode then ATIS will be permanently enabled and you will not be able to disable ATIS operation. Marcom-C mode is set by the dealer at point of sale. If you wish to enable or disable Marcom-C, please contact your Raymarine dealer.

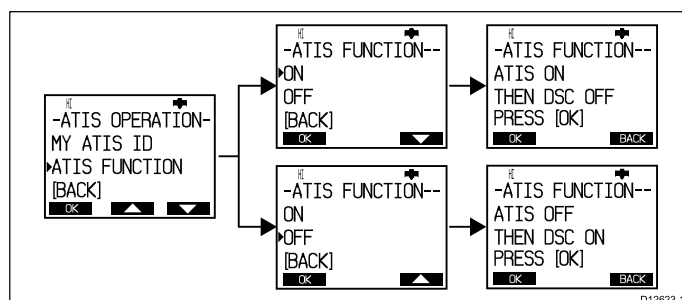

From the ATIS operation menu:

1. Select **ATIS Function**.
2. Select **ON** to enable the ATIS function, or  
The message **ATIS ON THEN DSC OFF** is displayed on-screen to warn that when ATIS is enabled then DSC functions are not available.
3. Select **OFF** to disable the ATIS function.  
The message **ATIS OFF THEN DSC ON** is displayed on-screen to warn that when ATIS is disabled then DSC functions are available again.

If no ATIS ID has been programmed then the message **PLEASE INPUT ATIS ID FIRST** is displayed.

## 8.8 AIS

The Ray260 AIS and Ray260E AIS have a built in AIS receiver.

With the built-in AIS receiver switched on AIS information can be sent to a connected Raymarine multifunction display using either the NMEA 0183 or SeaTalk<sup>®</sup> connections.

**Note:** If using the built-in AIS receiver and outputting over NMEA 0183, ensure that the baud rate is set to high speed:  
**Menu > Connection > Interface > NMEA 0183 > HIGH.**

### Switching the AIS function on and off

The AIS function on the Ray260 AIS and Ray260E AIS can be switched on or off.

From the main menu:

1. Select **CONNECTION**.
2. Select **AIS**.
3. Select ON or OFF as required.

## 8.9 Voice recorder

The radio includes a voice recorder function.

The voice recorder enables automatic recording of up to 90 seconds of a received transmission. For transmissions over 90 seconds long, only the first 90 seconds is recorded.

Only 1 recording can be saved at a time, when a new transmission is received any saved voice recording is automatically deleted.

Transmissions are not recorded when a scan mode or a watch mode is active.

### Recording transmissions

To enable automatic recording of transmissions the record function must be switched on.

From the main menu:

1. Select **VOICE RECORDER**.
2. Select **RECORD**.
3. Select ON to turn on automatic recording or,
4. Select OFF to turn off automatic recording.

### Playing back a recorded transmission

You can playback the last recorded transmission.

From the main menu:

1. Select **VOICE RECORDER**.
2. Select **REPLAY**.  
Details of the recorded transmission are displayed.
3. Select **PLAY**.  
Playback starts.
4. Select **STOP** at any time to stop the recording.

### Deleting a recording

You can delete a saved recording.

From the main menu:

1. Select **VOICE RECORDER**.
2. Select **DELETE** from the menu.
3. Select the **DELETE** soft button to confirm and delete the recording.

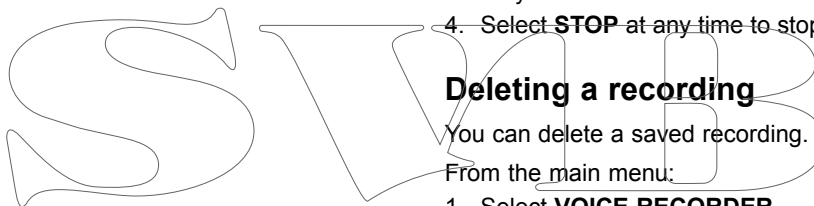

## 8.10 System configuration

The options available from the system configuration menu are shown below.

<b>BACKLIGHT</b>	Allows adjustment to the LCD's backlight level.	<ul style="list-style-type: none"> <li>• OFF to HIGH in 10 increments.</li> </ul>
<b>CONTRAST</b>	Allows adjustment to the LCD's contrast level.	<ul style="list-style-type: none"> <li>• LOW to HIGH in 10 increments.</li> </ul>
<b>KEY BEEP</b>	Allows adjustment of the beep heard when pressing handset buttons.	<ul style="list-style-type: none"> <li>• QUIET</li> <li>• LOUD</li> <li>• OFF</li> </ul>
<b>BEARING MODE</b>	Allows selection of bearing mode.	<ul style="list-style-type: none"> <li>• TRUE</li> <li>• MAGNETIC</li> </ul>
<b>SPEED UNIT</b>	Allows selecting of preferred speed units.	<ul style="list-style-type: none"> <li>• KNOTS</li> <li>• MPH</li> <li>• KPH</li> </ul>
<b>FOG FREQ</b>	The frequency of the fog horn can be set.	<ul style="list-style-type: none"> <li>• 50 Hz to 850 Hz in 50 Hz increments</li> </ul>
<b>LANGUAGE</b>	Allows selection of user interface language.	<ul style="list-style-type: none"> <li>• ENGLISH</li> <li>• SPANISH</li> <li>• FRENCH</li> <li>• GERMAN</li> <li>• ITALIAN</li> </ul>
<b>SYSTEM TEST</b>	The System test function performs test to ensure equipment is connected and where applicable the radio is receiving appropriate data.	<ul style="list-style-type: none"> <li>• GPS</li> <li>• Hailer</li> <li>• Battery</li> <li>• DSC</li> </ul>
<b>VERSION NUMBER</b>	Identifies current hardware and software versions.	
<b>RESET</b>	Performs a reset to restore data and settings to factory default values.  <b>Note:</b> The reset function will not reset MMSI and ATIS ID numbers.	

SWIB

# Chapter 9: Hailer, Fog horn, and Intercom

## Chapter contents

- [9.1 Hailer on page 62](#)
- [9.2 Fog horn on page 62](#)
- [9.3 Handset intercom on page 63](#)

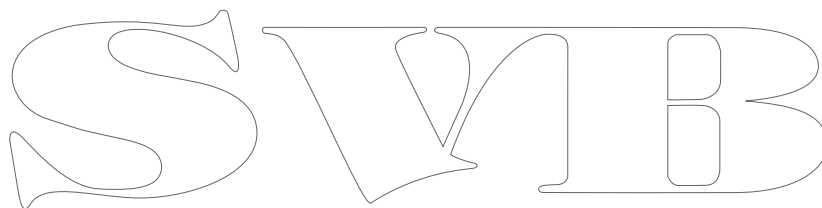

## 9.1 Hailer

The hailer function requires an optional loud hailer to be connected.

The hailer is an auxiliary function. When the hailer is active calls cannot be sent or received.

In hailer mode anything spoken into the handset is amplified and broadcast from the hailer, the message is not transmitted over the radio.

### Using the hailer

From the main menu:

1. Select **HAILER/FOG/IC**.
2. Select **HAILER**.
3. Press and hold the **PTT** button.
4. Speak your voice message.
5. Release the **PTT** button when voice message is complete.
6. Select **END** to exit hailer mode.

### Adjusting hailer volume

You can adjust the volume of the hailer function.

During an active hailer call:

1. Use the **Up Arrow** soft button to increase the hailer volume.
2. Use the **Down Arrow** soft button to decrease the hailer volume.

## 9.2 Fog horn

The fog horn function requires an optional loud hailer to be connected.

The fog horn function can be set to manual or to a predefined automatic mode

The predefined automatic modes consist of a sequence of tones which are then repeated.

Fog mode	Description	Pattern
<b>UNDERWAY</b>	Vessel underway	1 long tone
<b>UNDERWAY/STOPPED</b>	Vessel not underway	2 long tones
<b>SAILING/FISHING</b>	sailing vessel or any vessel fishing but not trolling	1 long tone and 2 short tones
<b>RESTRICT/TOW</b>	Restricted in ability to maneuver or towing another vessel	1 long tone and 2 short tones
<b>UNDER TOW</b>	This vessel is being towed	1 long tone and 3 short tones
<b>PILOT VESSEL</b>	This vessel is a pilot vessel	4 short tones
<b>AT ANCHOR</b>	Vessel is at anchor	12 consecutive rings
<b>AGROUND</b>	Vessel is aground	3 short rings, 12 consecutive rings, 3 short rings

In manual mode a continuous tone is sounded for as long as the PTT button is pressed.

**Note:** Radio calls can only be made between automatic fog horn soundings.

### Setting the fog horn mode

The fog horn can be set to manual or to a predefined automatic mode.

From the main menu:

1. Select **HAILER/FOG/IC**.
2. Select **FOG**.
3. Select **AUTO FOG** or **MANUAL FOG**.
4. If auto fog is selected then select the required auto fog mode.
5. Select **END** to exit fog horn mode and resume normal operation.

### Using the fog horn in manual mode

With the fog horn set to manual:

1. Press and hold the **PTT** button.  
A continuous tone is sounded as long as the PTT button is pressed.
2. Select **END** to exit fog horn mode and resume normal operation.

### Adjusting the fog horn volume

You can adjust the volume of the fog horn function.

During manual or auto fog horn mode:

1. Use the **Up Arrow** soft button to increase the hailer volume.
2. Use the **Down Arrow** soft button to decrease the hailer volume.

## 9.3 Handset intercom

Installations that contain more than 1 handset can use the intercom feature.

The intercom feature allows voice communication between connected handsets. The intercom call can be initiated from any handset.

### Using the intercom

From the main menu:

1. Select **HAILER/FOG/IC**.
2. Select **INTERCOM**.  
A list of connected handsets is displayed.
3. Select the handset you want to call.
4. Wait for the handset station to acknowledge the call.
5. Press and hold the **PTT** button and speak your message.

### Responding to the intercom

1. Press the **PTT** button and acknowledge the call and to respond to subsequent voice messages.

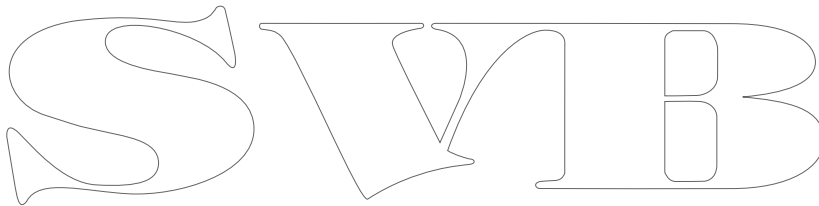

SWIB



# Chapter 10: Maintenance

## Chapter contents

- [10.1 Maintenance on page 66](#)
- [10.2 Routine checks on page 66](#)
- [10.3 Cleaning on page 67](#)
- [10.4 Unit cleaning instructions on page 67](#)

SWIB

## 10.1 Maintenance

The Ray260 has no user serviceable parts or adjustments. Never remove the cover or attempt to service the product, doing so may invalidate your product warranty.

The following preventive measures should be followed:

- Although the product is waterproof, keep the unit as dry as possible.
- If you remove a handset connection ensure the dust cap is fitted to the connector.

## 10.2 Routine checks

The following periodic checks should be made:

- Examine cables for signs of damage, such as chafing, cuts or nicks.
- Check that the cable connectors are firmly attached and that their locking mechanisms are properly engaged.

**Note:** Cable checks should be carried out with the power supply switched off.

SVIB

## 10.3 Cleaning

Best cleaning practices.

When cleaning this product:

- Do NOT wipe the display screen with a dry cloth, as this could scratch the screen coating.
- Do NOT use abrasive, or acid or ammonia based products.
- Do NOT use a jet wash.

## 10.4 Unit cleaning instructions

The unit does not require regular cleaning. However, if you find it necessary to clean the unit, please follow the steps below:

1. Ensure power is switched off.
2. Wipe unit clean with a damp cloth.
3. If necessary, use a mild detergent solution to remove grease marks.

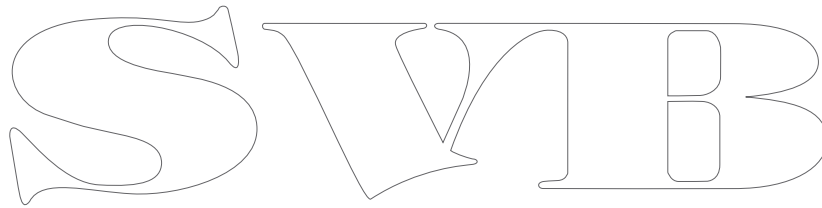
The image shows a stylized outline logo for the brand 'SWIB'. The letters are rendered in a decorative, outlined font. The 'S' is a large, bold, serif letter. The 'W' is a smaller, bold, serif letter. The 'I' is a simple, bold, serif letter. The 'B' is a large, bold, serif letter with a distinctive shape. The entire logo is centered on the page.

SWIB

# Chapter 11: Troubleshooting

## Chapter contents

- [11.1 Troubleshooting on page 70](#)
- [11.2 VHF Radio troubleshooting on page 71](#)

SWIB

## 11.1 Troubleshooting

The troubleshooting information provides possible causes and corrective action required for common problems associated with marine electronics installations.

All Raymarine products are, prior to packing and shipping, subjected to comprehensive test and quality assurance programs. However, if you experience problems with the operation of your product this section will help you to diagnose and correct problems in order to restore normal operation.

If after referring to this section you are still having problems with your unit, please contact Raymarine Technical Support for further advice.

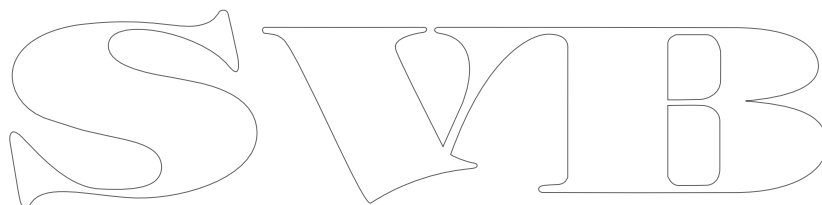
The image shows the letters 'S', 'W', and 'B' in a large, stylized, outlined font. The 'S' is on the left, followed by the 'W', and then the 'B' on the right. The letters are connected at the top and bottom, forming a continuous shape. The 'W' has a distinctive shape with a pointed top and a wide base. The 'B' has a rounded top and a wide base. The entire logo is rendered in a simple black outline.

## 11.2 VHF Radio troubleshooting

Problems with your VHF radio and their possible causes and solutions are described below:

Radio will not power up.	Loose wiring connection.	Check all cable connections.
	Blown fuse.	Check fuse and replace if necessary.
DSC functions are not working.	MMSI number not programmed.	Check MMSI number has been entered correctly.
	Radio is set to ATIS mode.	Use of DSC is not permitted in ATIS regions. You will be unable to make DSC distress and other types of digital selective call.
Position data is not shown.	Information not being received from GPS	<ul style="list-style-type: none"><li>• Check GPS is switched on and connected to the radio.</li><li>• Check correct interface is selected NMEA 0183 or NMEA 2000.</li><li>• Power cycle the radio.</li></ul>

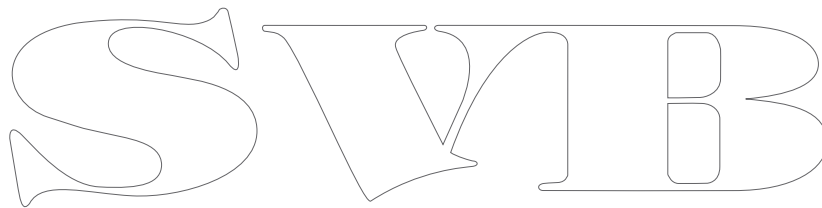
The logo consists of the letters 'S', 'V', 'I', and 'B' in a stylized, outlined font. The 'S' is a simple outline. The 'V' has a decorative, pointed bottom. The 'I' is a simple outline. The 'B' has a decorative, rounded bottom. The letters are arranged horizontally and are connected at the top and bottom.

SWIB



# Chapter 12: Technical support

## Chapter contents

- [12.1 Raymarine customer support on page 74](#)

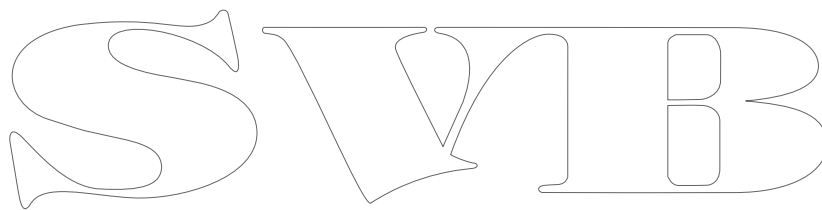

## 12.1 Raymarine customer support

Raymarine provides a comprehensive customer support service. You can contact customer support through the Raymarine website, telephone and e-mail. If you are unable to resolve a problem, please use any of these facilities to obtain additional help.

### Web support

Please visit the customer support area of our website at:

[www.raymarine.com](http://www.raymarine.com)

This contains Frequently Asked Questions, servicing information, e-mail access to the Raymarine Technical Support Department and details of worldwide Raymarine agents.

### Telephone and e-mail support

#### In the USA:

- **Tel:** +1 603 324 7900
- **Toll Free:** +1 800 539 5539
- **E-mail:** [support@raymarine.com](mailto:support@raymarine.com)

#### In the UK, Europe, and the Middle East:

- **Tel:** +44 (0)13 2924 6777
- **E-mail:** [ukproduct.support@raymarine.com](mailto:ukproduct.support@raymarine.com)

#### In Southeast Asia and Australia:

- **Tel:** +61 (0)29479 4800
- **E-mail:** [aus.support@raymarine.com](mailto:aus.support@raymarine.com)

### Product information

If you need to request service, please have the following information to hand:

- Product name.
- Product identity.
- Serial number.
- Software application version.
- System diagrams.

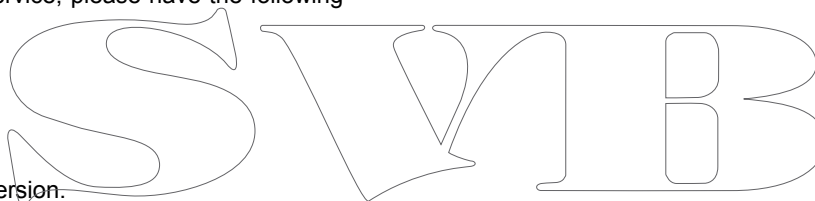

You can obtain this product information using the menus within your product.

# Chapter 13: Technical specification

## Chapter contents

- [13.1 Technical specification on page 76](#)

SWIB

# 13.1 Technical specification

## Environmental specification

Operating temperature	-20°C to +60°C
Storage temperature	-25°C to +70°C
Relative humidity	95%
Water proofing	<ul style="list-style-type: none"> <li>• Transceiver unit — IPX6</li> <li>• Handsets — IPX7</li> <li>• Loudspeakers — IPX7</li> </ul>
Connections	<ul style="list-style-type: none"> <li>• 1 x Power/NMEA/Audio</li> <li>• 3 x Handset / Active speaker</li> <li>• 1 x SeaTalk<sup>ng</sup></li> </ul>

## Power specification

Nominal supply voltage	12 V dc
Operating voltage range	10.8 V dc to 15.6 V dc
Current consumption	6 A Max at high power
LEN (Load Equivalency Number)	1

## Transmitter

Channels	All available US, International and Canadian VHF marine band
Frequency Range	156.025 MHz to 157.425 MHz 155.500 MHz to 163.275 MHz (Private channels)
Frequency stability	+/- 5 ppm
Channel Spacing	25 kHz
Power Output	<ul style="list-style-type: none"> <li>• Low power setting — 1 W</li> <li>• High power setting — 25 W</li> </ul>
Duty cycle	5% transmit, 5% receive, 90% standby
Modulation	Frequency modulation
Spurious emissions	Better than -36 dBm at 25 W
Maximum deviation	+/- 5 KHz
Antenna impedance	50 Ohms (typical)

## Receiver

Receiver type	Double conversion super heterodyne
Channels	All available US, International and Canadian VHF marine band
Frequency range	156.025 MHz to 157.425 MHz 155.500 MHz to 163.275 MHz (Private channels)
Sensitivity (12 dB) SINAD	Less than 0.35 µV
Adjacent channel selectivity	Better than 80 dB
Spurious noise rejection	Better than -80 dB
Inter modulation rejection	80 dB (typical)
Audio output (active speaker)	5 W
Audio distortion	Less than 10%
Hum and noise in audio	Better than -40 dB

## Handset

Audio output power	3.5 W (typical)
--------------------	-----------------

## Hailer

Audio output power	30 W (typical)
Hailer impedance	4 Ohms

## Speakers

Passive speaker impedance	8 Ohms
---------------------------	--------

## Conformance

USA: FCC CFR47 parts 2, 15 and 80
Industry Canada: RSS182
EU: R&TTE directive 1999/5/EC
China: CCS IACS — E10
Australia and New Zealand —C-Tick mark: AS-NZS4415.1 — 2003 + Amd 1:2004
International: IEC 62238 and ITU-r M.493-13

## Radio usage

The radio can be used worldwide, including the following European countries:

AT	CZ	FI	IE	LU	PL	SK
BE	DE	FR	IS	LV	PT	TR
BG	DK	GB	IT	MT	RO	
CH	EE	GR	LI	NL	SE	
CY	ES	HU	LT	NO	SI	

# Chapter 14: Spares and accessories

## Chapter contents

- [14.1 Ray260 Spares & Accessories on page 78](#)
- [14.2 SeaTalk<sup>ng</sup> cables and accessories on page 78](#)

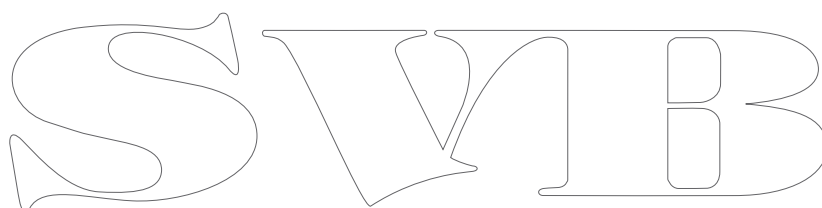

## 14.1 Ray260 Spares & Accessories

The following spares and accessories are available for the Ray260 VHF radio.

Description	Part Number
Ray260 handset US version with 10 m (32.8 ft.) adaptor cable	A80196
Ray260 handset US version with 20 m (65.6 ft.) adaptor cable	A80249
Ray260 handset EU version with 10 m (32.8 ft.) adaptor cable	A80197
Ray260 handset EU version with 20 m (65.6 ft.) adaptor cable	A80250
Passive speaker with 1.5 m (4.9 ft.) cable attached	A80198
Active speaker with 1.5 m (4.9 ft.) cable attached	A80199
Ray260 handset extension cable 5 m (16.4 ft)	A80200
Ray260 handset extension cable 10 m (32.8 ft)	A80201
Ray260 handset extension cable 15 m (49.2 ft)	A80202
Ray260 handset adaptor cable 10 m (32.8 ft)	R70166
Ray260 handset adaptor cable 20 m (65.6 ft.)	R70167
Power/Data cable 1 m (3.3 ft.)	A80205

## 14.2 SeaTalk<sup>ng</sup> cables and accessories

SeaTalk<sup>ng</sup> cables and accessories for use with compatible products.

Description	Part No	Notes
SeaTalk <sup>ng</sup> starter kit	T70134	Includes: <ul style="list-style-type: none"> <li>• 1 x 5 Way connector (A06064)</li> <li>• 2 x Backbone terminator (A06031)</li> <li>• 1 x 3 m (9.8 ft) spur cable (A06040)</li> <li>• 1 x Power cable (A06049)</li> </ul>
SeaTalk <sup>ng</sup> Backbone Kit	A25062	Includes: <ul style="list-style-type: none"> <li>• 2 x 5 m (16.4 ft) Backbone cable (A06036)</li> <li>• 1 x 20 m (65.6 ft) Backbone cable (A06037)</li> <li>• 4 x T-piece (A06028)</li> <li>• 2 x Backbone terminator (A06031)</li> <li>• 1 x Power cable (A06049)</li> </ul>
SeaTalk <sup>ng</sup> 0.4 m (1.3 ft) spur	A06038	
SeaTalk <sup>ng</sup> 1 m (3.3 ft) spur	A06039	
SeaTalk <sup>ng</sup> 3 m (9.8 ft) spur	A06040	
SeaTalk <sup>ng</sup> 5 m (16.4 ft) spur	A06041	
SeaTalk <sup>ng</sup> 0.4 m (1.3 ft) elbow spur	A06042	
SeaTalk <sup>ng</sup> 0.4 m (1.3 ft) backbone	A06033	
SeaTalk <sup>ng</sup> 1 m (3.3 ft) backbone	A06034	
SeaTalk <sup>ng</sup> 3 m (9.8 ft) backbone	A06035	
SeaTalk <sup>ng</sup> 5 m (16.4 ft) backbone	A06036	
SeaTalk <sup>ng</sup> 9 m (29.5 ft) backbone	A06068	
SeaTalk <sup>ng</sup> 20 m (65.6 ft) backbone	A06037	
SeaTalk <sup>ng</sup> to bare ends 1 m (3.3 ft) spur	A06043	
SeaTalk <sup>ng</sup> to bare ends 3 m (9.8 ft) spur	A06044	
SeaTalk <sup>ng</sup> Power cable	A06049	
SeaTalk <sup>ng</sup> Terminator	A06031	
SeaTalk <sup>ng</sup> T-piece	A06028	Provides 1 x spur connection
SeaTalk <sup>ng</sup> 5-way connector	A06064	Provides 3 x spur connections
SeaTalk <sup>ng</sup> backbone extender	A06030	
SeaTalk to SeaTalk <sup>ng</sup> converter kit	E22158	Allows the connection of SeaTalk devices to a SeaTalk <sup>ng</sup> system.

Description	Part No	Notes
SeaTalk <sup>ng</sup> Inline terminator	A80001	Provides direct connection of a spur cable to the end of a backbone cable. No T-piece required.
SeaTalk <sup>ng</sup> Blanking plug	A06032	
ACU / SPX SeaTalk <sup>ng</sup> spur cable 0.3 m (1.0 ft)	R12112	Connects an SPX course computer or an ACU to a SeaTalk <sup>ng</sup> backbone.
SeaTalk (3 pin) to SeaTalk <sup>ng</sup> adaptor cable 0.4 m (1.3 ft)	A06047	
SeaTalk to SeaTalk <sup>ng</sup> spur 1 m (3.3 ft) spur	A22164	
SeaTalk2 (5 pin) to SeaTalk <sup>ng</sup> adaptor cable 0.4 m (1.3 ft)	A06048	
DeviceNet adaptor cable (Female)	A06045	Allows the connection of NMEA 2000 devices to a SeaTalk <sup>ng</sup> system.
DeviceNet adaptor cable (Male)	A06046	Allows the connection of NMEA 2000 devices to a SeaTalk <sup>ng</sup> system.
DeviceNet adaptor cable (Female) to bare ends.	E05026	Allows the connection of NMEA 2000 devices to a SeaTalk <sup>ng</sup> system.
DeviceNet adaptor cable (Male) to bare ends.	E05027	Allows the connection of NMEA 2000 devices to a SeaTalk <sup>ng</sup> system.

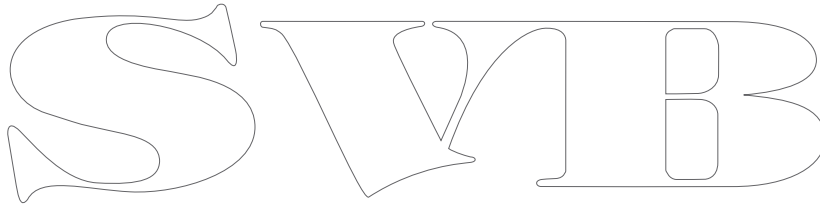

SWIB



## Appendix A NMEA 0183 sentences

The radio supports the following NMEA 0183 sentences.

Sentence	Description	Ray260 / Ray260E		Ray260 AIS / Ray260E AIS	
		Receive	Transmit	Receive	Transmit
DSC	Digital Selective Calling		•		•
DSE	Expanded Digital Selective Calling		•		•
VDM	AIS VHF Data Link Message				•
GGA	Global Positioning System Fix Data	•		•	
GLL	Geographic Position — Lat/Long	•		•	
GNS	GNSS Fix Data	•		•	
RMA	Recommended Minimum Specific Loran-C Data	•		•	
RMC	Recommended Minimum Specific GNSS Data	•		•	

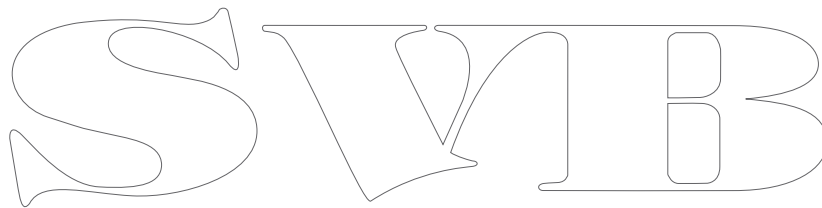

SVMB

## Appendix B NMEA 2000 sentences

The radio supports the following NMEA 2000 sentences. These are applicable to NMEA 2000 and SeaTalk<sup>ng</sup> protocols.

Sentence	Description	Ray260 / Ray 260E		Ray260 AIS / Ray260E AIS	
		Receive	Transmit	Receive	Transmit
59904	ISO Acknowledgement	•	•	•	•
59392	ISO Request	•		•	
60928	ISO Address Claim	•	•	•	•
65240	ISO Commanded Address	•		•	
126208	NMEA — Group Function	•	•	•	•
126464	PGN List		•		•
126996	Product Information		•		•
126026	COG / SOG Rapid Update	•		•	
126029	GNSS Position Data	•		•	
129038	AIS Class A Position report				•
129039	AIS Class B Position Report				•
129040	AIS Class B Extended Position				•
129040	AIS SAR Aircraft Position Report		•		•
129040	Radio Frequency / Mode / Power		•		•
129808	DSC Call Information		•		•
129809	AIS Class B “CS” Static Data Report, Part A				•
129810	AIS Class B “CS” Static Data Report, Part B				•
129793	AIS UTC Date and Time Report				•
129801	AIS Safety Related Broadcast Addressed				•
129041	AIS Aids to Navigation				•
129044	Datum	•		•	

## Appendix C VHF Channels

### US Marine VHF Channels and Frequencies

CH No.	TX Freq	RX Freq	Single Freq	Use
01A	156.050	156.050	x	Port operations and commercial, VTS. Available only in New Orleans / Lower Mississippi area.
03A	156.150	156.150	x	US Government only.
05A	156.250	156.250	x	Port operations or VTS in the Houston, New Orleans and Seattle areas.
06	156.300	156.300	x	Intership Safety.
07A	156.350	156.350	x	Commercial.
08	156.400	156.400	x	Commercial (Intership only).
09	156.450	156.450	x	Boater calling. Commercial and Non-commercial.
10	156.500	156.500	x	Commercial.
11	156.550	156.550	x	Commercial. VTS in selected areas.
12	156.600	156.600	x	Port operations. VTS in selected areas.
13	156.650	156.650	x	Intership navigation safety (Bridge-to-bridge). Ships >20 metres in length maintain a listening watch on this channel in US waters.
14	156.700	156.700	x	Port operations. VTS in selected areas.
15	-	156.750	x	Environmental (Receive only). Used by Class 'C' EPIRBs.
16	156.800	156.800	x	International Distress, Safety and Calling. Ships required to carry radio, USCG, and most coast stations maintain a listening watch on this channel.
17	156.850	156.850	x	State Control.
18A	156.900	156.900	x	Commercial.
19A	156.950	156.950	x	Commercial.
20	157.000	161.600		Port operations (duplex).
20A	157.000	157.000	x	Port operations.
21A	157.050	157.050	x	US Coast Guard only.
22A	157.100	157.100	x	Coast Guard Liaison and Maritime Safety Information Broadcasts. Broadcasts announced on channel 16.
23A	157.150	157.150	x	US Coast Guard only.
24	157.200	161.800		Public correspondence (Marine operator).
25	157.250	161.850		Public correspondence (Marine operator).
26	157.300	161.900		Public correspondence (Marine operator).
27	157.350	161.950		Public correspondence (Marine operator).
28	157.400	162.000		Public correspondence (Marine operator).
61A	156.075	156.075	x	US Government only.
63A	156.175	156.175	x	Port operations and commercial VTS, Available only in New Orleans / Lower Mississippi area.
64A	156.225	156.225	x	US Coast Guard only.
65A	156.275	156.275	x	Port operations.
66A	156.325	156.325	x	Port operations.
67	156.375	156.375	x	Commercial. Used for bridge-to-bridge communications in lower Mississippi river (Intership only).
68	156.425	156.425	x	Non-commercial.
69	156.475	156.475	x	Non-commercial.
71	156.575	156.575	x	Non-commercial.
72	156.625	156.625	x	Non-commercial (Intership only).

CH No.	TX Freq	RX Freq	Single Freq	Use
73	156.675	156.675	x	Port operations.
74	156.725	156.725	x	Port operations.
77	156.875	156.875	x	Port operations (Intership only).
78A	156.925	156.925	x	Non-commercial.
79A	156.975	156.975	x	Commercial. Non-commercial in Great Lakes only).
80A	157.025	157.025	x	Commercial. Non-commercial in Great Lakes only).
81A	157.075	157.075	x	US Government only — Environmental protection operations.
82A	157.125	157.125	x	US Government only.
83A	157.175	157.175	x	US Government only.
84	157.225	161.825		Public correspondence (Marine operator).
85	157.275	161.875		Public correspondence (Marine operator).
86	157.325	161.925		Public correspondence (Marine operator).
87	157.375	161.975		Public correspondence (Marine operator).
88	157.425	162.025		Public correspondence only near the Canadian border
88A	157.425	157.425	x	Commercial, Intership only.

Please be aware that:

- Recreational boaters normally use channels listed as Non-commercial: 68, 69, 71, 72 78A.
- Channel 70 is used exclusively for DSC and is not available for regular voice communications.
- Channels 75 and 76 are reserved as guards bands for channel 16 and are not available for regular voice communications.

**Note:**

1. The letter 'A' following a channel number indicates simplex use of the ship station transmit side of an international semi-duplex channel. Operations are different from that of international operations on that channel.
2. Channel 13 should be used to contact a ship when there is danger of collision. All ships of length 20 metres or greater are required to guard VHF channel 13, in addition to VHF channel 16, when operating within US territorial waters.
3. Channel 15 is receive only.
4. Channel 16 is used for calling other stations or for distress calls.
5. Channel 17 and channel 77 have a fixed power output of 1 watt.
6. Channel 13 and channel 67 have an initial power output of 1 watt. User can temporarily override this restrictions to transmit at high power.

**Canadian Marine VHF Channels and Frequencies**

CH No.	TX Freq	RX Freq	Area of operation	Use
01	156.050	160.650	PC	Public correspondence.
02	156.100	160.700	PC	Public correspondence.
03	156.150	160.750	PC	Public correspondence.
04A	156.200	156.200	PC	Intership, ship/shore and safety: Canadian Coast Guard search and rescue.
04A	156.200	156.200	EC	Intership, ship/shore and commercial: Commercial fishing only.
05A	156.250	156.250		Ship movement.
06	156.300	156.300	All areas	Intership, commercial, non-commercial and safety: Maybe used for search and rescue communications between ships and aircraft.
07A	156.350	156.350	All areas	Intership, ship/shore, commercial.
08	156.400	156.400	WC, EC	Intership, commercial and safety. Also assigned for operations in the Lake Winnipeg area.

CH No.	TX Freq	RX Freq	Area of operation	Use
09	156.450	156.450	AC	Intership, ship/shore, commercial, non-commercial and ship movement. Maybe used to communicate with aircraft and helicopters in predominantly maritime support operations.
10	156.500	156.500	AC, GL	Intership, ship/shore, commercial, non-commercial, safety and ship movement. May also be used for communications with aircraft engaged in coordinated search and rescue and antipollution operations.
11	156.550	156.550	PC, AC, GL	Intership, ship/shore, commercial, non-commercial and ship movement. Also used for pilotage purposes.
12	156.600	156.600	WC, AC, GL	Intership, ship/shore, commercial, non-commercial and ship movement. Port operations and pilot information and messages.
13	156.650	156.650	All areas	Intership, commercial, non-commercial and ship movement. Exclusively for bridge-to-bridge navigational traffic. Limited to 1 watt maximum power.
14	156.700	156.700	AC, GL	Intership, ship/shore, commercial, non-commercial and ship movement. Port operations and pilot information and messages.
15	156.750	156.750	All areas	Intership, ship/shore, commercial, non-commercial and ship movement. All operations limited to 1 watt maximum power. May also be used for on-board communications.
16	156.800	156.800	All areas	International distress, safety and calling.
17	156.850	156.850	All areas	Intership, ship/shore, commercial, non-commercial and ship movement. All operations limited to 1 watt maximum power. May also be used for on-board communications.
18A	156.900	156.900	All areas	Intership, ship/shore, commercial. Towing on the Pacific coast.
19A	156.950	156.950	All areas except PC	Intership, ship/shore. Canadian Coast Guard only
19A	156.950	156.950	PC	Intership, ship/shore. Various government departments.
20	157.00	161.600	All areas	Ship/shore, safety and ship movement. Port operations limited to 1 watt maximum power.
21A	157.050	157.050	All areas	Intership and ship/shore. Canadian Coast Guard only.
21B	-	161.650	All areas	Safety: Continuous Marine Broadcast (CMB) service.
22A	157.100	157.100	All areas	Intership, ship/shore, commercial and non-commercial. For communications between Canadian Coast Guard and non-Canadian Coast Guard stations only.
23	157.150	161.750	PC	Ship/shore and public correspondence. Also in the inland waters of British Columbia
24	157.200	161.800	All areas	Ship/shore and public correspondence.
25	157.250	161.850	PC	Ship/shore and public correspondence. Also assigned for operations in the Lake Winnipeg area.
25B	-	161.850	AC	Safety: Continuous Marine Broadcast (CMB) service.
26	157.300	161.900	All areas	Ship/shore, safety and public correspondence.
27	157.350	161.950	AC, GL, PC	Ship/shore and public correspondence.
28	157.400	162.00	PC	Ship/shore, safety and public correspondence.
28B	-	162.000	AC	Safety: Continuous Marine Broadcast (CMB) service.
60	156.025	160.625	PC	Ship/shore and public correspondence.
61A	156.075	156.075	PC	Intership and ship/shore Canadian Coast Guard only.
61A	156.075	156.075	EC	Intership, ship/shore and commercial Commercial fishing only.
62A	156.125	156.125	PC	Intership and ship/shore Canadian Coast Guard only.
62A	156.125	156.125	EC	Intership, ship/shore and commercial Commercial fishing only.
64	156.225	160.825	PC	Ship/shore and public correspondence.

CH No.	TX Freq	RX Freq	Area of operation	Use
64A	156.225	156.225	EC	Intership, ship/shore and commercial Commercial fishing only.
65A	156.275	156.275		Intership, ship/shore, commercial, non-commercial and safety. Search and rescue and antipollution operations on the Great Lakes. Towing on the Pacific coast. Port operations only in the St. Lawrence river area limited to 1 watt maximum power. Pleasure craft in the inland waters of Alberta, Saskatchewan and Manitobs (excluding Lake Winnipeg and the Red River.
66A	156.325	156.325		Intership, ship/shore, commercial, non-commercial, safety and ship movement. Port operations only in the St. Lawrence river / Great Lakes areas limited to 1 watt maximum power.
67	156.375	156.375	EC	Intership ship/shore and commercial. Commercial fishing only.
67	156.375	156.375	All areas except EC	Intership, ship/shore, commercial, non-commercial, safety. May also be used for communications with aircraft engaged in coordinated search and rescue and antipollution operations.
68	156.425	156.425	All areas	Intership, ship/shore and non-commercial. For marinas and yacht clubs.
69	156.475	156.475	All areas except EC	Intership, ship/shore, commercial and non-commercial.
69	156.475	156.475	EC	Intership, ship/shore and commercial. Commercial fishing only.
71	156.575	156.575	PC	Intership, ship/shore, commercial, non-commercial, safety and ship movement.
71	156.575	156.575		Intership, ship/shore and non-commercial. For marinas and yacht clubs on the east coast and on Lake Winnipeg.
72	156.625	156.625	EC, PC	Intership, commercial and non-commercial May be used to communicate with aircraft and helicopters in predominantly maritime support operations.
73	156.675	156.675	EC	Intership, ship/shore and commercial. Commercial fishing only.
73	156.675	156.675	All areas except EC	Intership, ship/shore, commercial, non-commercial and safety. May also be used for communications with aircraft engaged in coordinated search and rescue and antipollution operations.
74	156.725	156.725	EC, PC	Intership, ship/shore, commercial, non-commercial and ship movement.
77	156.875	156.875		Intership, ship/shore, safety and ship movement. Pilotage on Pacific coast. Port operations only in the St. Lawrence river / Great Lakes areas limited to 1 watt maximum power.
78A	156.925	156.925	EC, PC	Intership, ship/shore and commercial.
79A	156.975	156.975	EC, PC	Intership, ship/shore and commercial.
80A	157.025	157.025	EC, PC	Intership, ship/shore and commercial.
81A	157.075	157.075		Intership, ship/shore. Canadian Coast Guard use only in the St. Lawrence river / Great Lakes areas.
81A	157.075	157.075	PC	Intership, ship/shore and safety. Canadian Coast Guard antipollution.
82A	157.125	157.125	PC	Intership, ship/shore and safety. Canadian Coast Guard use only.
82A	157.125	157.1258		Intership and ship/shore. Canadian Coast Guard use only in the St. Lawrence river / Great Lakes areas.
83	157.175	161.775	PC	Ship/shore and safety. Canadian Coast Guard use only.
83A	157.175	157.175	EC	Intership and ship/shore Canadian Coast Guard and other government agencies.
83B	-	161.775	AC, GL	Safety: Continuous Marine Broadcast (CMB) service.
84	157.225	161.825	PC	Ship/shore and public correspondence.
85	157.275	161.875	AC, GL ,NL	Ship/shore and public correspondence.
86	157.325	161.925	PC	Ship/shore and public correspondence.

CH No.	TX Freq	RX Freq	Area of operation	Use
87	157.375	161.975	AC, GL, NL	Ship/shore and public correspondence.
88	157.425	162.025	AC, GL, NL	Ship/shore and public correspondence.

**Area of operation**

- **AC** — Atlantic Coast, Gulf and St. Lawrence River up to and including Montreal.
- **EC** — East Coast: includes NL, AC, GL and Eastern Arctic areas.
- **GL** — Great Lakes: includes St. Lawrence above Montreal.
- **NL** — Newfoundland and Labrador.
- **PC** — Pacific Coast.
- **WC** — West Coast: includes PC, Western Arctic and Athabasca-Mackenzie Watershed areas.
- **All areas** — Includes East and West Coast areas.

**Note:**

1. An 'A' following a channel number indicates simplex use of the ship station transmit side of an international duplex channel. Operations are different from that of international operations on that channel.
2. Channel 16 is used for calling other stations or for distress calls.
3. A 'B' following a channel number indicates simplex use of the coast station transmit side of an international duplex channel. The channel is receive only
4. Channel 70 is used exclusively for Digital Selective Calling and is not available for regular voice communications.
5. Channel 75 and channel 76 are reserved as guard bands for channel 16 and are not available for regular voice communications.

**International Marine VHF Channels and Frequencies**

CH No.	TX Freq	RX Freq	Single Freq	Use
01	156.050	160.650		Public correspondence, Port operations and Ship movement.
02	156.100	160.700		Public correspondence, Port operations and Ship movement.
03	156.150	160.750		Public correspondence, Port operations and Ship movement.
04	156.200	160.800		Public correspondence, Port operations and Ship movement.
05	156.250	160.850		Public correspondence, Port operations and Ship movement.
06	156.300	156.300	x	Intership.
07	156.350	160.950		Public correspondence, Port operations and Ship movement.
08	156.400	156.400	x	Intership.
09	156.450	156.450	x	Intership, Port operations and Ship movement.
10	156.500	156.500	x	Intership, Port operations and Ship movement.
11	156.550	156.550	x	Port operations and Ship movement.
12	156.600	156.600	x	Port operations and Ship movement.
13	156.650	156.650	x	Intership, Safety, Port operations and Ship movement.
14	156.700	156.700	x	Port operations and Ship movement.
15	156.750	156.750	x	Intership, on-board communications limited to 1 watt maximum power.
16	156.800	156.800	x	Distress, Safety and Calling
17	156.850	156.850	x	Intership, on-board communications limited to 1 watt maximum power.
18	156.900	161.500		Public correspondence, Port operations and Ship movement.
19	156.950	161.550		Public correspondence, Port operations and Ship movement.
20	157.000	161.600		Public correspondence, Port operations and Ship movement.
21	157.050	161.650		Public correspondence, Port operations and Ship movement.
22	157.100	161.700		Public correspondence, Port operations and Ship movement.
23	157.150	161.750		Public correspondence, Port operations and Ship movement.
24	157.200	161.800		Public correspondence, Port operations and Ship movement.
25	157.250	161.850		Public correspondence, Port operations and Ship movement.
26	157.300	161.900		Public correspondence, Port operations and Ship movement.
27	157.350	161.950		Public correspondence, Port operations and Ship movement.

CH No.	TX Freq	RX Freq	Single Freq	Use
28	157.400	162.000		Public correspondence, Port operations and Ship movement.
60	156.025	160.625		Public correspondence, Port operations and Ship movement.
61	156.075	160.675		Public correspondence, Port operations and Ship movement.
62	156.125	160.725		Public correspondence, Port operations and Ship movement.
63	156.175	160.775		Public correspondence, Port operations and Ship movement.
64	156.225	160.825		Public correspondence, Port operations and Ship movement.
65	156.275	160.875		Public correspondence, Port operations and Ship movement.
66	156.325	160.925		Public correspondence, Port operations and Ship movement.
67	156.375	156.375	x	Intership, Port operations and Ship movement.
68	156.425	156.425	x	Port operations and Ship movement.
69	156.475	156.475	x	Intership, Port operations and Ship movement.
71	156.575	156.575	x	Port operations and Ship movement.
72	156.625	156.625	x	Intership.
73	156.675	156.675	x	Intership.
74	156.725	156.725	x	Port operations and Ship movement.
75	156.775	156.775	x	See Note 5.
76	156.825	156.825	x	See Note 5.
77	156.875	156.875	x	Intership.
78	156.925	161.525		Public correspondence, Port operations and Ship movement.
79	156.975	161.575		Public correspondence, Port operations and Ship movement.
80	157.025	161.625		Public correspondence, Port operations and Ship movement.
81	157.075	161.675		Public correspondence, Port operations and Ship movement.
82	157.125	161.725		Public correspondence, Port operations and Ship movement.
83	157.175	161.775		Public correspondence, Port operations and Ship movement.
84	157.225	161.825		Public correspondence, Port operations and Ship movement.
85	157.275	161.875		Public correspondence, Port operations and Ship movement.
86	157.325	161.925		Public correspondence, Port operations and Ship movement.
87	157.375	157.375	x	Port operations and Ship movement.
88	157.425	157.425	x	Port operations and Ship movement.

Please be aware that:

- Intership channels are for communications between ship stations. Intership communications should be restricted to channels 6, 8, 72 and 77. If these are not available, the other channels marked for Intership may be used.
- Channel 70 is used exclusively for Digital Selective Calling (DSC) and is not available for regular voice communications.

**Note:**

1. Channel 06 may also be used for communications between ship stations and aircraft engaged in coordinated search and rescue operations. Ship stations should avoid harmful interference to such communications on channel 06 as well as to communications between aircraft stations, ice breakers and assisted ships during ice seasons.
2. Within the European Maritime Area and in Canada, channels 10, 67 and 73 may also be used by the individual administrations concerned for communication between ship stations, aircraft stations and participating land stations engaged in coordinated search and rescue and anti-pollution operations in local areas. Channel 10 or 73 (depending on location) are also used for the broadcast of Marine Safety Information by the Maritime and Coast Guard Agency in the UK only.
3. Channel 13 is designated for use on a worldwide basis as a navigation safety communication channel, primarily for intership navigation safety communications.
4. Channels 15 and 17 may also be used for on-board communications provided the effective radiated power does not exceed 1 Watt.
5. The use of channels 75 and 76 should be restricted to navigation related communications only and all precautions should be taken to avoid harmful interference to channel 16. Transmit power is limited to 1 Watt.



### Private Channels (Europe only)

Country	Channel Designations	TX Freq	RX Freq	Channel Use
Belgium	96	162.425	162.425	Marina
Denmark	L1	155.500	155.500	Pleasure
	L2	155.525	155.525	Pleasure
Finland, Norway & Sweden	L1	155.500	155.500	Pleasure
	L2	155.525	155.525	Pleasure
	L3	155.650	155.650	Pleasure
Holland (Netherlands)	31	157.550	162.150	Marina
	37	157.850	157.850	Leisure
Denmark, Finland, Norway & Sweden	F1	155.625	155.625	Fishing
	F2	155.775	155.775	Fishing
	F3	155.825	155.825	Fishing
United Kingdom	M1	157.850	157.850	Marina
	M2	161.425	161.425	Marina

The national channels listed above have been allocated for the specific use within the countries listed. To use these channels you must have the appropriate license.

### WX Channels (North America only)

Weather Channel	Frequency in MHz
WX1	162.550
WX2	162.400
WX3	162.475
WX4	162.425
WX5	162.450
WX6	162.500
WX7	162.525
WX8	161.650
WX9	161.775
WX10	163.275

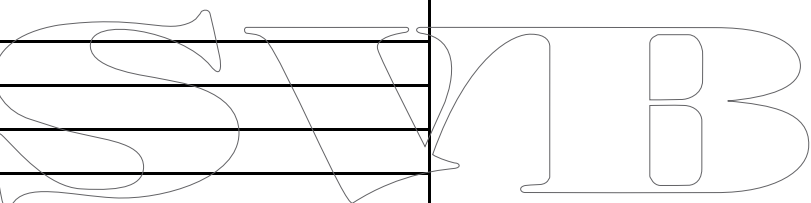

## Appendix D Phonetic alphabet

To help make call letters more clearly understood, and to assist in spelling out similar sounding or unfamiliar word, radiotelephone users employ the international phonetic alphabet.

A	ALPHA	N	NOVEMBER
B	BRAVO	O	OSCAR
C	CHARLIE	P	PAPA
D	DELTA	Q	QUEBEC
E	ECHO	R	ROMEO
F	FOXTROT	S	SIERRA
G	GOLF	T	TANGO
H	HOTEL	U	UNIFORM
I	INDIA	V	VICTOR
J	JULIET	W	WHISKEY
K	KILO	X	X-RAY
L	LIMA	Y	YANKEE
M	MIKE	Z	ZULU

A large graphic consisting of the letters 'S', 'W', 'I', and 'B' in a stylized, outlined font. The letters are connected and have a decorative, slightly irregular appearance, resembling a calligraphic or hand-drawn style.

## Appendix E Prowords

Prowords can be used to simplify and speed up radio communications.

Proword	Meaning
<b>ACKNOWLEDGE</b>	Have you received and understood?
<b>CONFIRM</b>	Is that correct?
<b>CORRECTION</b>	An error has been made?
<b>I SAY AGAIN</b>	I repeat (e.g. important information).
<b>I SPELL</b>	Phonetically spelling of the word.
<b>OUT</b>	End of communication.
<b>OVER</b>	I have completed this part of the message and am inviting you to reply.
<b>RECEIVED</b>	Receipt acknowledgement.
<b>SAY AGAIN</b>	Repeat your message.
<b>STATION CALLING</b>	Used when a station is uncertain of the identity of a station which is calling.

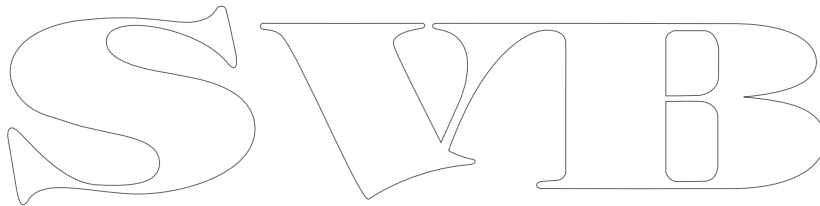

SWIB

SWIB

**Raymarine®**  
A FLIR COMPANY  
SVIB