



EW3 152 063 13 (24V)

Fischio Elettronico con due segnali nebbia
(Tromba per imbarcazioni da 20m a 75m)

Electronic Whistle with two fog signals
(Marine Horn for vessels between 20m to 75m in length)



SWIB



Fischio Elettronico 24V

Tromba Nautica per imbarcazioni da 20m a 75m

Codice/Code
152 063 13 (24V)

N.B.

Le funzioni di questo prodotto vengono attivate sia tramite cablaggio su morsettiera sia attraverso il pannello di controllo opzionale collegabile all'unità elettronica principale tramite cavo RJ45 non incrociato (pin to pin) ad 8 poli tutti cablati.

Se le funzioni vengono attivate utilizzando il cablaggio della morsettiera, devono essere disattivate tramite cablaggio medesimo.

Se le funzioni vengono attivate utilizzando il cablaggio del pannello di controllo (SB, SB-MC, SB-ML), devono essere disattivate tramite cablaggio medesimo.

PLEASE NOTE.

Operations of this product are activated whether using wiring harness on terminal board or using the control panel that can be connected to the electric unit through RJ45 cable 8 poles not crossed (pin to pin).

If functions are activated with the wiring harness of the terminal board, they must be deactivated using the wiring harness of the terminal board.

If functions are activated with the wiring harness of the control panel (SB, SB-MC,SB-ML), they must be deactivated using the wiring harness of the control panel.

SWIB



Fischio Elettronico 24V

Tromba Nautica per imbarcazioni da 20m a 75m

Codice/Code
152 063 13 (24V)

Descrizione del prodotto: avvisatore acustico elettronico omologato costituito da gruppo altoparlante IP67 e centralina elettronica con funzioni di: generatore 690Hz, amplificatore di voce in classe AB e due segnali automatici da nebbia o due segnali automatici personalizzabili. Omologazione RINA e LLOYD'S REGISTER in accordo alle norme internazionali COLREG 1972 IMO classe III, approvato NMMA ABYC A-23

Dati Tecnici

Codice Articolo	V	A	Potenza Sonora	Frequenza	Dimensioni del Fischio	Totale Peso Kit
152 063 13	24	4	> 130 dB(1/3 Oct.) a 1m	690Hz	Ø320 x 440 mm	7,72 kg

ISTRUZIONI PER L'INSTALLAZIONE ELETTRICA DEL FISCHIO E L'IMPOSTAZIONE DEI TONI AUTOMATICI

Avvertenza importante: allo scopo di garantire una perfetta tenuta, l'unità magnetodinamica (driver) del gruppo altoparlante viene fornita pre-cablata con cavo stagnato lungo 1,5 m di sezione 2x1,5mm². Il collegamento va quindi effettuato sul cavo con idonea scatola di derivazione. Non sostituire il cavo né aprire l'unità. Un'etichetta di sicurezza è applicata al pressacavo per evitare manomissioni che invaliderebbero la garanzia.

1. Montare il gruppo altoparlante inclinandolo leggermente verso il basso per evitare il ristagno d'acqua all'interno del cono.
2. Aprire il coperchio della centralina elettronica ed identificare la morsettiera con 8 contatti contrassegnati.
3. Eseguire i collegamenti elettrici come descritto nello schema allegato.
4. Collegamento del microfono: fare riferimento allo schema allegato.
5. Descrizione principali funzioni :

A. Tono Manuale. Per attivare manualmente un qualsiasi tono, collegare un PULSANTE attraverso i contatti morsettiera marcati 1 e 2.

NOTA - QUESTO PULSANTE HA SEMPRE L'ASSOLUTA PRIORITA' SU TUTTE LE ALTRE FUNZIONALITA', INCLUSO IL MICROFONO.

B. Primo segnale da Nebbia 60/90 secondi. La selezione dell'intervallo 60" o 90" avviene tramite il dip switch (vedere schema allegato).

Collegando con un interruttore i morsetti 1 e 3 come da schema di cablaggio si ottiene l'attivazione del segnale da nebbia.

C. Secondo segnale da Nebbia 60/90 secondi. La selezione dell'intervallo 60" o 90" avviene tramite il dip switch (vedere schema allegato).

Collegando con un interruttore i morsetti 1 e 4 come da schema di cablaggio si ottiene l'attivazione del segnale da nebbia.

D. Tono Personalizzato. Il Segnale da Nebbia di default della durata di 5" può essere sostituito da una nuova impostazione personalizzata, intervallata 60" o 90" in base alla posizione del dip switch. La personalizzazione vale per entrambi i segnali da nebbia.



Fischio Elettronico 24V

Tromba Nautica per imbarcazioni da 20m a 75m

Codice/Code
152 063 13 (24V)

Procedura per l'impostazione personalizzata dei segnali da nebbia.

- 1) Attivare il Segnale da Nebbia automatico.
- 2) DURANTE LA FASE DI PAUSA DEL SEGNALE DA NEBBIA, premere il Pulsante Tono Manuale, impostando quindi una serie di impulsi corti/lunghi a scelta per un massimo di 8 impulsi.

Nota - Toni corti(2") e lunghi(5") vengono automaticamente generati in base al tempo di pressione del pulsante (pressione inferiore di 2" = tono di 2", mentre pressione superiore di 2" = tono di 5"). Per confermare la sequenza personalizzata bisogna posizionare l'interruttore del segnale da nebbia su OFF entro 10 secondi dall'ultimo segnale della sequenza di personalizzazione. Un beep acustico, successivo all'operazione (dopo 5 secondi), conferma la memorizzazione della sequenza personalizzata. Per la personalizzazione del secondo segnale da nebbia la procedura è la medesima. L'unica differenza è che si hanno due beeps di conferma della personalizzazione del tono alla fine della procedura.

- 3) Per reimpostare l'originale segnale di default occorre seguire la procedura di personalizzazione del tono da nebbia, tenendo premuto una sola volta il pulsante Tono Manuale per un tempo superiore di 2".

D. Entrata ausiliaria (AUX INPUT). Per l'attivazione di un segnale audio esterno fare riferimento alla morsettiera a quattro contatti come da schema allegato.

N.B. Tutte le funzioni precedentemente descritte sono attivabili anche da pannello di controllo da plancia, opzionale.

Risoluzione di problemi: nel caso di mancato funzionamento del sistema procedere come segue :

Verificare la continuità del fusibile ed eventualmente sostituirlo.

Sconnettere i cavi dell'altoparlante dalla centralina e controllare con un tester la lettura in tra i due cavi.

- Se la lettura è zero (corto circuito) o infinito (circuito aperto), verificare l'integrità della linea dell'altoparlante e se il fenomeno persiste inviare il solo driver al centro assistenza.
- Se la lettura è compresa fra $6 \div 8$, il gruppo altoparlante è funzionante e quindi far controllare solo la centralina al centro assistenza.

GARANZIA

- 1) Il periodo di garanzia è di 2 anni dalla data d'acquisto come risulta dalla relativa fattura.
- 2) Nel caso la fattura non fosse disponibile il periodo di garanzia di 2 anni, sarà calcolato dalla data di fabbricazione.
- 3) La garanzia decade e s'intende nulla in caso d'utilizzazione non corretta o nel caso venissero ignorate le istruzioni contenute nel presente manuale.
- 4) La garanzia copre solamente i difetti di fabbricazione.
- 5) La garanzia non copre i costi connessi di installazione e smontaggio.
- 6) I costi di trasporto sono rimborsabili solo nel caso in cui la garanzia è stata debitamente riconosciuta e accettata da Marco S.p.A. Questi costi saranno limitati ai costi di spedizione tra il magazzino di Marco S.p.A. e la sede del cliente.
- 7) Nessuna nota di credito o reso sarà emessa prima di un test eseguito dal controllo di qualità di Marco S.p.A. che dichiara difettoso il prodotto.



Electronic Whistle 24V

Marine Horns for vessels between
20m to 75m in length

Codice/Code
152 063 13 (24V)

Product description: approved electronic whistle complete with loudspeaker IP67, electronic controller with functions of: 690Hz frequency generator, class AB voice amplifier and automatic fog signal or automatic customised signal.

Meets COLREG 1972 IMO class III international regulations with RINA and LLOYD'S REGISTER homologations, NMMA ABYC A-23 approved

Technical Data

Product Code	V	A	Acoustic Power	Frequency	Horn Dimensions	Total Kit Weight
152 063 13	24	4	>130dB(1/3 Oct.) at 1m	690Hz	Ø320 x 440 mm	7,72 kg

INSTRUCTIONS FOR THE ELECTRICAL INSTALLATION OF THE WHISTLE AND SETTING OF THE SIGNAL TONES

Important notice: in order to ensure complete water-tightness, the loudspeaker driver unit is supplied with a factory fitted electrical cable 1,5 m long, tin-plated and 2x1,5mm² section. Do not replace this cable or open the driver unit as the cable gland has a security tag to prevent tampering and consequential warranty invalidations. A suitable terminal junction box should be used to complete the cable connections.

1. Mount the loudspeaker in a slightly downward tilt position in order to prevent water entrapment inside the cone.
2. Open the Electronic Controller coverlid and identify the marked 8 pin terminal block.
3. Complete the electrical installation as shown in the attached wiring diagram.
4. Microphone connection: look at the diagram attached
5. Main functions description :

A. Manual Tone. To obtain a manually activated free tone, install a pushbutton switch control across the terminal contacts marked 1 and 2.

NOTE - THIS PUSHBUTTON HAS ALWAYS ABSOLUTE PRIORITY OVER ALL OTHER FUNCTIONS, INCLUDING THE MICROPHONE.

B. Fog Horn Signal-60/90 seconds. A fog-horn signal repeated at 60" or 90" intervals is obtained with dip switch, putting connections across the terminal pins marked 1 and 3 as per the attached diagram. The default signal is a tone of 5" duration.

Note - The activation of this tone is pre-empted by a 0.3" acoustical beep

C. Customized Tone. The Fog Horn default signal of 5" duration can be substituted by a customized tone setting, respectively intervalled at 60" or 90" depending on the dip switch position.



Electronic Whistle 24V

Marine Horns for vessels between
20m to 75m in length

Codice/Code
152 063 13 (24V)

Procedure to set a customized tone

- 1) Activate the automatic Fog Horn switch control.
- 2) Input a chosen series of short/long tones, maximum 8 tones, DURING THE PAUSE INTERVAL PHASE OF THE FOG HORN CYCLE, by pressing the Manual Tone pushbutton accordingly.

Note - Short(2") and long(5") tones are automatically generated depending on the activation time of the pushbutton (activation time shorter than 2" = a short tone, while activation time longer than 2" = a long tone). To confirm the customized sequence you have to put the fog signal switch on "OFF" position by 10 sec. from latest sound of customized sequence.

One sound beep follow this operation (5 seconds) and confirm the memorisation of customized sequence.

- 3) To re-instate the default signal follow up customisation tone procedures by pressing the Manual Tone pushbutton with a single impulse longer than 2".

D. Aux input. To activate the external sound signal use the 4 stud terminal block as per the attached diagram

Note - All previous functions (a./b./c./d.) are operable with optional control panel

Problem resolutions: in the case of a system malfunction proceed as follows :

Check fuse continuity and replace if necessary

Disconnect loudspeaker connections at the controller box and check the reading between the connections using a tester.

- If reading is zero (short circuit) or infinity (open circuit), verify the loudspeaker line continuity and if problem persists then return only the driver to your Customer Service Centre.

- If reading is between 6 - 8 Ω , then the loudspeaker unit is functional and only the electronic controller box should be returned to your Customer Service Centre.

WARRANTY

- 1) The Warranty period is 2 years from date of purchase on production of the appropriate sales invoice.
- 2) Should the original sales invoice not be available, then the 2 year warranty period will be valid from date of production.
- 3) The Warranty becomes null and void in the case of incorrect utilization or disregard of the instructions contained herein.
- 4) The Warranty only covers original production defects.
- 5) The Warranty does not cover any related installation costs involved.
- 6) Transport costs are refundable only in the case where warranty has been duly recognized and accepted by Marco Spa. These costs will be limited to the actual shipment costs between Marco Spa warehouse and the client's delivery address.
- 7) No credit notes or replacement items will be issued prior to the receipt and proper testing of any Marco goods that are deemed faulty.

WIRING DIAGRAM / SCHEMA ELETTRICO ELECTRONIC WHISTLE / FISCHIO ELETTRONICO

Codes/Codici
EW3 (24V) 152 063 13

ATTENZIONE / WARNING

Se i cavi di alimentazione e quelli dell'altoparlante non verranno connessi ai rispettivi morsetti, l'elettronica si danneggerà irrimediabilmente.

If the power cables and loudspeaker wires are not connected in the right terminal blocks, the electronic unit will be irreparably damaged

Evitare assolutamente il contatto tra i cavi dell'altoparlante durante la fase di installazione. In caso di cortocircuito verificare la continuità del fusibile.

During the installation process, **absolutely avoid** the contact between the two loudspeaker copper wires. In case of short circuit check fuse continuity.

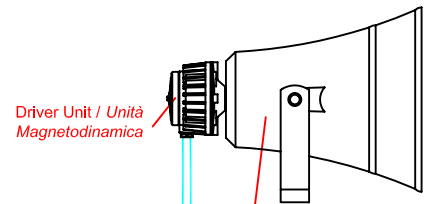

**LOUDSPEAKER
GRUPPO ALTOPARLANTE**

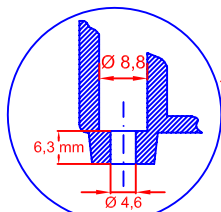
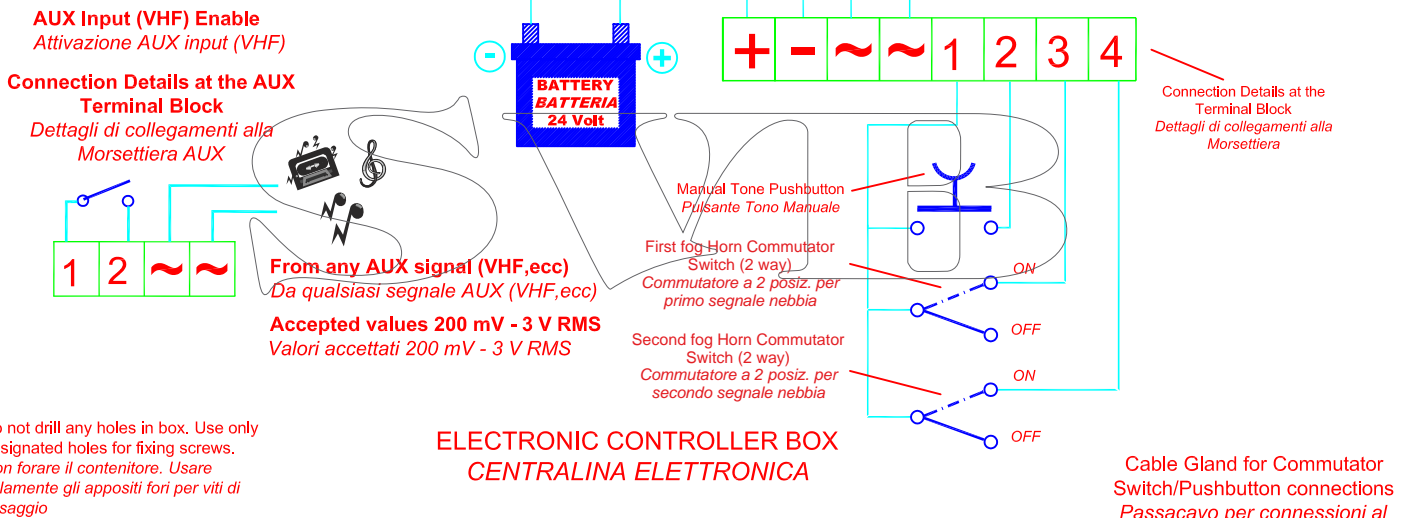

Hole/Foro
Ø 4,6 mm

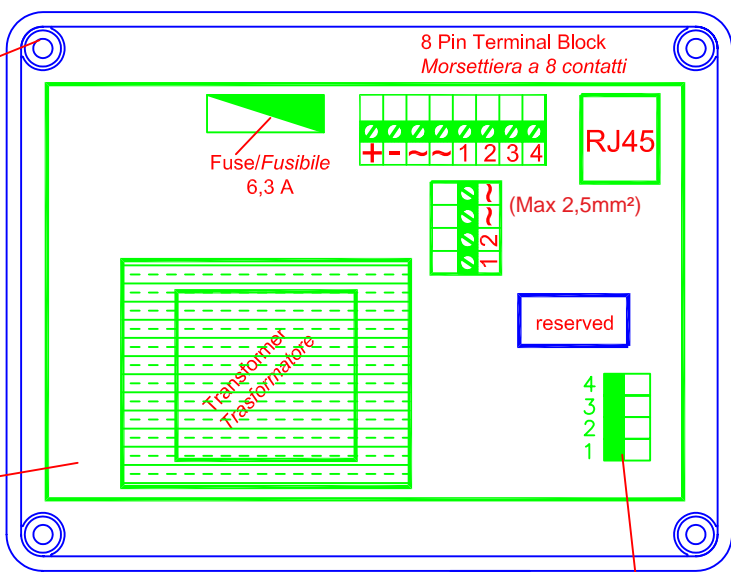

Printed Circuit Board
Circuito Stampato

Cable Gland for Commutator Switch/Pushbutton connections
Passacavo per connessioni al Commutatore/Pulsante

Cable Gland for horn connections
Passacavo per connessione tromba

Cable Gland for battery connections
Passacavo per connessione batteria

60" 90"

4
FOG SELECTION

ON OFF

1
HORN HEATING

1
HORN HEATING

TYPE APPROVAL CERTIFICATE
No. **ELE556806CS/1**



This is to certify that the product below is found to be in compliance with the applicable requirement of the RINA type approval system.

<i>Description</i>	SHIP'S WHISTLE
<i>Type</i>	5.722 ; 5.723
<i>Applicant</i>	MARCO SPA VIA MAMELI 10 25014 CASTENEDOLO (BS) ITALIA
<i>Manufacturer</i>	MARCO SPA
<i>Place of manufacture</i>	VIA MAMELI 10 25014 CASTENEDOLO (BS) ITALIA
<i>Reference standards</i>	International Regulations for preventing collisions at sea, 1972 referred to Italian Law 27th December 1977 no. 1085.

Issued in **Genoa** on **March 29, 2007**. *This Certificate is valid until* **March 29, 2012**

Valerio Bonanni

RINA

Valerio Bonanni

This certificate consists of this page and 1 enclosure





TYPE APPROVAL CERTIFICATE

No. **ELE556806CS/1**

Enclosure - Page 1 of 1

5.722 ; 5.723

Reference documents

Drawings Nos. 5.72-22-23 ; 5..722-23A ; 5.722.01 and technical specification stamped by RINA on 13 September 1991.

Field of application

Vessels $20 \leq L < 75$ metri

Feeder

Electric

Electrical characteristics

- Rated voltage : (V) 12 -24
- Rated electrical power (supply) : (W) 120.

Remarks

- Sound signal equipment to be used according to the instructions given by the manufacturer.

Genoa March 29, 2007

[Signature]
SVIB



TYPE APPROVAL CERTIFICATE
N. ELE059512CS/001

This is to certify that the product below is found to be in compliance with the applicable requirements of the RINA type approval system.

<i>Description</i>	Ship's Whistle
<i>Type</i>	EW 3
<i>Applicant</i>	MARCO S.p.A Via Mameli , 10 25014 Castenedolo (BS) ITALY
<i>Manufacturer</i>	MARCO S.p.A. Via Mameli , 10 25014 Castenedolo (BS) ITALY
<i>Testing Standards</i>	Convention on the International Regulations for preventing collision at sea , 1972_ ed. 2003 (ref. to Italian Law 27 th Dec. 1977 n. 1085)

Issued in Genova on March 09, 2012.

This certificate is valid until March 29 2017

Valerio Bonanni

RINA

Valerio Bonanni

Genova, March 09, 2012

1/2

RINA S.p.A.
Via Corsica, 12 – 16128 Genova
Tel. +39 010 53851
Fax +39 010 5351000



TYPE APPROVAL CERTIFICATE
N. ELE059512CS/001

Ship's Whistle EW3 (12 and 24Vdc)

Field of application

Recreational vessels having length from 20 to 75 metres

Electrical characteristics

Rated voltage: 12 - 24Vdc

Rated electrical power supply : 120 W.

Operating frequency: 698 Hz

Acoustic pressure: > 130 dB (1/3 Oct.) @ 1m

Reference documents

Marco technical description: GC/UTEC 30/07/1991

Marco dwgs: n. 5.72-22-23 ; 5..722-23A ; 5.722.01 and technical specification stamped by RINA on 13 September 1991.

Marco Letter on 08/02/2012

Test Reports

Marco reports n. 5722 (08/28/1991) and 5723 (08/28/1991)

Marco report n. 53591T001

Emit - Las report n. RP1681 F1A 91 (09/1991)

Intek _ report n. RP 07-0395 Rev. 00 (31/07/2007)

Remarks

Sound signal equipment to be installed and used according to the manufacturer instruction.

Genoa March 09, 2012

Genova, March 09, 2012

RINA S.p.A.
Via Corsica, 12 - 16128 Genova
Tel. +39 010 53851
Fax +39 010 5351000

2/2

CERTIFICATE OF TYPE APPROVAL

This is to certify that

LLOYD'S REGISTER, specified as a "person" under the terms of The Merchant Shipping (Delegation of Equipment Approval) Regulations 1996, did undertake the relevant type approval procedures of the equipment identified below which was found to be in compliance with the essential Life Saving Appliance requirements subject to any conditions in the Design Appraisal Document hereto.

Producer Marco SpA
Address Via Marneti 10
25014 Castenedolo
Brescia
Italy

Equipment Description SHIPS SOUND SIGNAL (WHISTLE) ELECTRIC POWERED

Type EW3 12V supply
EW3 24V supply

Specified Standard International Regulations for Preventing Collisions at Sea 1972, Consolidated Edition 2002, Annex III, 1(a) to (d) inclusive.

The attached Design Appraisal Document forms part of this certificate.

This certificate remains valid up to the expiry dated unless cancelled or revoked, or until such date where it is superseded by the requirements of the Marine Equipment Directive whichever is the earlier, provided the conditions in the attached schedule are complied with and the equipment remains satisfactory in service.

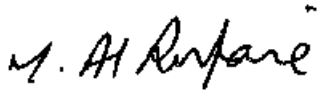
Date of issue	12 July 2008	Expiry date	10 April 2013
Certificate No.	MCA 0300007/M1	Signed	
Sheet No	1 of 2	Name	M.H.A. Rufaie Surveyor to Lloyd's Register EMEA A Member of the Lloyd's Register Group

Note:

This certificate is not valid for equipment, the design or manufacture of which has been varied or modified from the specimen tested. The manufacturer should notify the nominated body named on this certificate of any modification or changes to the equipment in order to obtain a valid Certificate.



Maritime and Coastguard Agency

An Executive Agency of the Department for Transport

This certificate is issued under the authority given in Merchant Shipping Notice No MSN 1735 (M+F) as amended to date.

Page 2 of 2
Document number MCA 0300007/M1
Issue number 1

DESIGN APPRAISAL DOCUMENT

Date 12 July 2008	Quote this reference on all future communications LDSS/PAS/TAE/W01644471/MHR/O- 92578
----------------------	--

ATTACHMENT TO CERTIFICATE OF TYPE APPROVAL No. MCA 0300007/M1

The undernoted documents have been appraised for compliance with the relevant International Conventions and UK legislation for the Type Approval of Marine Equipment for use on Merchant Ships Registered in the United Kingdom.

This Design Appraisal Document forms part of the Certificate that is issued under the authority given in the MCA Merchant Shipping Notice No MSN 1735.

ADDITIONAL APPROVAL DOCUMENTATION

Request form	10.02.2008
LR Brescia email	11.03.2008
Marco letter	10.03.2008

TEST REPORTS

IQNet Certificate No. CH-21294	07.02.2006
SQS Certificate No. 21294	07.02.2006

Also all the documentation listed on Design Appraisal Document associated with MCA Certificate No. 0300007



M.H.A. RUFFAIE
Lead Specialist
Product Approval / London Design Support Services
Tel: +44 (0) 20 7423 1849 (Direct line)
Email: product-approval@lr.org
Web: www.lr.org



MARINE DIVISION

Certificate number: 14449/B0 BV

File number: NAV 39/1469/01

Product code: 4005H

This certificate is not valid when presented without the full attached schedule composed of 7 sections.

www.veristar.com

TYPE APPROVAL CERTIFICATE

This certificate is issued to

MARCO SpA
Brescia - ITALY

for the type of product

SHIP's SOUND SIGNALS (WHISTLES)

Electric whistle type: EW2/EW3

Requirements:

Bureau Veritas Rules for the Classification of Steel Ships.

S V M B

This certificate is issued to attest that BUREAU VERITAS did undertake the relevant approval procedures for the product identified above which was found to comply with the relevant requirements mentioned above.

This certificate will expire on: 02 Sep 2015

For BUREAU VERITAS,

At BV GENOA, on 02 Sep 2010,

Gianni Pirovano



This certificate remains valid until the date stated above, unless cancelled or revoked, provided the conditions indicated in the subsequent page(s) are complied with and the product remains satisfactory in service. This certificate will not be valid if the applicant makes any changes or modifications to the approved product, which have not been notified to, and agreed in writing with BUREAU VERITAS. Should the specified regulations or standards be amended during the validity of this certificate, the product(s) is/are to be re-approved prior to it/they being placed on board vessels to which the amended regulations or standards apply. This certificate is issued within the scope of the General Conditions of BUREAU VERITAS Marine Division available on the internet site www.veristar.com. Any Person not a party to the contract pursuant to which this document is delivered may not assert a claim against BUREAU VERITAS for any liability arising out of errors or omissions which may be contained in said document, or for errors of judgement, fault or negligence committed by personnel of the Society or of its Agents in establishment or issuance of this document, and in connection with any activities for which it may provide.

THE SCHEDULE OF APPROVAL

1. PRODUCT DESCRIPTION:

Types	Voltage	Frequency	Sound pressure level (1m)
EW2 12V Electric whistle EW2 24V Electric whistle	12 V 24 V	692 Hz 690 Hz	121 dB 121.6 dB
EW3 12V Electric whistle EW3 24V Electric whistle	12 V 24 V	698 Hz 698 Hz	130.3 dB 130.4 dB

2. DOCUMENTS AND DRAWINGS:

According to Manufacturer's specifications filed in NAV 39/1469/01.

3. TEST REPORTS:

3.1 - Electric whistle EW2 12V/EW2 24V:

Department of Trade Marine Directorate Certificate of Inspection and Tests,
EMIT Vibration test report RP 1425 FIA 90.

3.2 - Electric whistle EW3 12V/EW3 24V:

Department of Trade Marine Directorate Certificate of Inspection and Tests,
EMIT Vibration test report RP 1681 FIA 91.

4. APPLICATION / LIMITATION:

4.1 - Electric whistle type EW2 12V 12 V vessels < 20 m,

Electric whistle type EW2 24V 24 V vessels < 20 m,

Electric whistle type EW3 12V 12 V vessels $20 \leq L < 75$ m,

Electric whistle type EW3 24V 24 V vessels $20 \leq L < 75$ m.

4.2 - Protection index IP is to be in accordance with the location of the whistle.

4.3 - On board installation & Maintenance requirements are to be in accordance with the specified regulations and standards stated on the front page of the certificate.

5. PRODUCTION SURVEY REQUIREMENTS:

5.1 - The EW2 12V, EW2 24V, EW3 12V, EW3 24V Electric Whistles are to be manufactured, examined and tested by **MARCO SpA, 25014 Castenedolo (BS) - Italia**, in accordance with the type described in this certificate and Bureau Veritas Rules for the Classification of Steel Ships.

5.2 - Production sites are to be recognized by Bureau Veritas as per NR320 for HBV products. To this end **MARCO SpA, 25014 Castenedolo (BS) - Italia**, has to make the necessary arrangements for a Society's Surveyor to perform visits and product audits at the production sites.

5.3 - **MARCO SpA, 25014 Castenedolo (BS) - Italia**, has declared to Bureau Veritas that the type of product described in this certificate may be manufactured at the following production site:

MARCO SpA
Via Mameli 28,
25014 Castenedolo Brescia
ITALY

6. MARKING OF PRODUCT:

6.1 - Maker's name or trade mark,

6.2 - Serial number of the units,

6.3 - Equipment type number or model identification under which it was type-tested.

7. OTHERS:

7.1 - This approval is given on the understanding that the Society reserves the right to require check tests to be carried out on the Whistles at any time and that **MARCO SpA, 25014 Castenedolo (BS) - Italia**, will accept full responsibility for informing shipbuilders, shipowners or their sub-contractors of the proper methods of use and general maintenance of the units and the conditions of this approval.

7.2 - This Certificate supersedes the Type Approval Certificate N° 14449/A0 issued on 31/01/2005 by the Society.

*** END OF CERTIFICATE ***

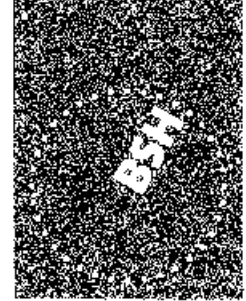

BSH - Postfach 30 12 20 - 20305 Hamburg

Marco
Via Mameli 10
25014 CASTENEDOLO Brescia
italien

BUNDESAMT FÜR
SEESCHIFFFAHRT
UND
HYDROGRAPHIE

Dienststz Hamburg

Ihr Antrag auf Baumusterprüfung von Navigationsausrüstung vom 03.09.2007
Your application for type examination of navigation equipment dated 03.09.2007

Erlaß
12 September 2007

Durchwahl
+ 49 (0) 40 3190 7324

Aktenzeichen
(bitte bei Antwort angeben)

BSH/4615/5020678/07

Bescheid über die Anerkennung einer nationalen Zulassung eines EU-Mitgliedstaates

Notification of acceptance of a national type approval of a EU member state

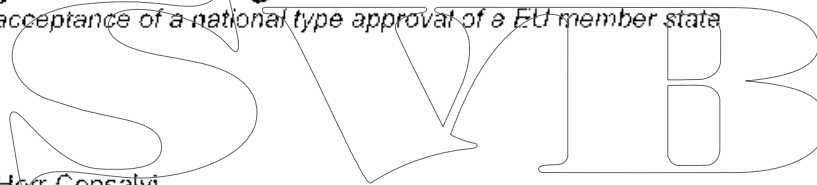

Sehr geehrter Herr Consalvi,
Dear Mr. Consalvi,

für die Navigations Ausrüstung mit der Bezeichnung **EW2, EW3**
For the navigation equipment with the type designation EW2, EW3

wird die mit anliegendem Zertifikat Nr. **MCA0300008, MCA0300007**
the approval granted with attached certificate no. MCA0300008, MCA0300007

für MCA(UK) ausgesprochene Zulassung vom Bundesamt für Seeschifffahrt
und Hydrographie (BSH) für die Anwendung auf Schiffen unter Deutscher
Flagge akzeptiert.

*Will be accepted by the Federal Maritime and Hydrographic Agency (BSH) for the
use on german flag vessels.*

Bedingungen

Conditions

Diese Anerkennung erlischt bei Fristablauf, Rücknahme oder Widerruf. Der
Widerruf kann ausgesprochen werden, wenn die serienmäßig gefertigten
nautischen Ausrüstungsgegenstände nicht mit dem zugelassenen
Baumuster übereinstimmen.

*This acceptance expires after lapse of time, withdrawal or revocation. A revocation may be
ordered if navigational equipment manufactured in serial production is not in compliance with
the type-tested prototype.*

Bernhard-Noch-Str. 78
20359 Hamburg
Tel: + 49 (0) 40 3190 - 0
Fax: + 49 (0) 40 3190 - 5000
posteingang@bsh.de
www.bsh.de

Bankverbindung:
Bundeskasse Kiel
zugunsten BSH
Deutsche Bundesbank
1 7 210 000 00
Kto. Nr. 210 010 31

IBAN
DE42 2100 0000 0001 0010 00
BIC: MARKDE33HAN

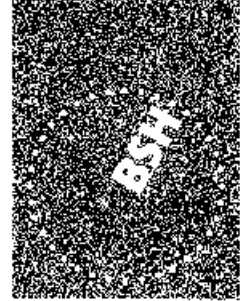

BUNDESAMT FÜR
SEESCHIFFFAHRT
UND
HYDROGRAPHIE

Rechtsbehelfsbelehrung

Notice on legal remedies available

Gegen diesen Bescheid kann innerhalb eines Monats nach Bekanntgabe Widerspruch erhoben werden. Der Widerspruch ist beim Bundesamt für Seeschifffahrt und Hydrographie, Bernhard-Nocht-Str. 78, 20359 Hamburg, schriftlich oder zur Niederschrift einzulegen.¹

Objection to this document may be filed within one month after notification. The objection must be filed in writing to, or put on record at, Federal Maritime and Hydrographic Agency, Bernhard Nocht Str. 78, 20359 Hamburg, Germany.

Anlage(n) Gebührenbescheid KASSENZEICHEN 7900 57035 715

Attachment(s) invoice KASSENZEICHEN 7900 57035 715

Mit freundlichen Grüßen

Im Auftrag

By order:

Preuss

BSFH

¹ Der deutsche Text ist verbindlich.
The german text is authentic.

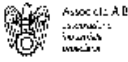

DICHIARAZIONE DI CONFORMITA' C.E. E.C. DECLARATION OF CONFORMITY

Confermiamo che il prodotto:
We confirm that the product:

152 063 013 - EW3 24V Fischio Elettronico / Electronic Whistle

E' conforme alla Direttiva 2004/108/CE (ex.89/336/CE) relativa alla Compatibilità Elettromagnetica.
Is in conformity with the Directive 2004/108/EC (ex.89/336/EC) relating to Electromagnetic Compatibility.

Questa dichiarazione è valida per tutti gli articoli prodotti secondo la documentazione tecnica che è parte di questa dichiarazione. In caso di eventuali verifiche pertinenti alla Compatibilità Elettromagnetica sono state applicate le seguenti normative:

This declaration is valid for all products which are produced in accordance with the technical documentation which is a part of this declaration. For verification of conformity with regard to Electromagnetic Compatibility the following standards are applied:

EN 60945 2002-10

Apparecchiature e sistemi di navigazione marittima e di radiocomunicazione
Prescrizioni generali - Metodi di prova e risultati delle prove richieste
*Maritime navigation and radio communication equipment and system
General requirements - Methods of testing and required test results*

Questa dichiarazione è rilasciata sotto la responsabilità esclusiva di:
This declaration is given under the sole responsibility of:

MARCO S.P.A.
Via Mameli 10 - 25014 Castenedolo - Brescia - Italy
Tel. 030/2134.1 Fax 030/2134.300

SWIB

Per ulteriori informazioni vedere nostro sito internet - www.marco.it
Marco S.p.A Via Mameli 10 - 25014 Castenedolo - Brescia - Italia
tel. +39 030 2134.1 / Fax +39 030 2134.300

For further information visit the our web site - www.marco.it
Marco S.p.A Via Mameli 10 - 25014 Castenedolo - Brescia - Italy
tel. +39 030 2134.1 / Fax +39 030 2134.300