

easy 3
TRX

AIS Class B SOTDMA

User Guide

V2

Englisch



1 References

1.1 General Warning

All marine automatic identification system (AIS) units utilize a satellite based system such as the global positioning satellite (GPS) network or the global navigation satellite system (GLONASS) network to determine position. The accuracy of these networks is variable and is affected by factors such as the antenna positioning, how many satellites are used to determine a position and how long satellite information has been received for. Therefore it is desirable wherever possible to verify both your vessels AIS derived position data and other vessels AIS derived position data with visual or radar based observations.

The easyTRX3 software is intended for use as an installation and configuration tool. The application is not a navigation tool and should not be used as such.

1.2 Licensing (MMSI) for AIS Class B

Important: in most countries the operation of an AIS unit is included under the vessels marine VHF license provisions. The vessel on to which the AIS Class B unit is installed must therefore possess a current VHF radiotelephone license for the AIS Class B unit which lists the AIS system and the vessel call sign and MMSI number. Please contact the relevant authority in your country for more information. In accordance with our policy of continual development and product improvement the easyTRX3 hardware and software may be upgraded from time to time and future versions of the easyTRX3 may therefore not correspond exactly with this manual. When necessary, upgrades to the product will be accompanied by updates or addenda to this manual. Please take time to read this manual carefully and to understand its contents fully so that you can install and operate your AIS system correctly.

Information contained in this manual is liable to change without notice. Weatherdock AG disclaims any liability for consequences arising from omissions or inaccuracies in this manual and any other documentation provided with this product.

1.3 Warnings and Precautions

It is the sole responsibility of the owner/operator of the ship to command the vessel safely and to be in full control of all operating conditions during the entire travel time. By mistaken conduct of the operator of a ship equipped with a device from the easyTRX3 product line if the operator does pay undivided attention to operation and surrounding condition damage or personal injury may be caused in the event of an accident.

1.4 Application Federal Network Agency

The official application form for the usage of an AIS Class B Transceiver in Germany can be downloaded at the German Federal Network Agency's homepage. Please follow this link:

https://www.bundesnetzagentur.de/SharedDocs/Downloads/DE/Sachgebiete/Telekommunikation/Unternehmen_Institutionen/Nummerierung/TechnischeNummern/SeeBinnenschiffahrt/funk/AntragNummernzuteilungSportschiffahrt.pdf

1.5 Approval Number BSH

BSH/4542/001/4323246/18

1.6 Revision Level

Stand 1.0, Author: MK, 02/2019
Stand 2.0, Author: MK, 05/2019

1.7 Restrictions

There are no known restrictions for the usage of the easyTRX3 in EU countries.

2 Index of Abbreviations

Abbreviations

CPA	Closest point of approach
LAN	Local area network
NMEA	National Marine Electronics Association
SSID	Service set identifier device
VHF	Very High Frequency
VSWR	voltage standing wave ratio
WiFi	wireless fidelity -connect to a network by radio
GNSS	global navigation satellite system
MMSI	Maritime mobile service identity
HDOP	horizontal dilution of precision

3 Pictures/Sketches Overview

Figure: 1 Box content	7
Figure: 2 Connectors	9
Figure: 3 Connection possibilites and cable colours	10
Figure: 4 CPA Alert.....	11
Figure: 5 Anchor Alert connection sketch	12
Figure: 6 RX only	12
Figure: 7 External signal generator connection sketch	13
Figure: 8 Base connection by USB for programming	14
Figure: 9 Feature functionality while connected by USB for programming.....	14
Figure: 10 directory information of internal storage of the easyTRX3.....	15
Figure: 11 start screen	16
Figure: 12 Connection screen programming software.....	17
Figure: 13 data flow screen connection software	17
Figure: 14 Basic setup screen programming software	18
Figure: 15 Basic setup screen programming software2	19
Figure: 16 Advance setting screen programming software	20
Figure: 17 Advance setting screen programming software 2	21
Figure: 18 Distance Filter screen programming software.....	23

Figure: 19 Save screen programming software	24
Figure: 20 AIS transmitter settings programming software	25
Figure: 21 AIS transmitter settings programming software 2	25
Figure: 22 Long-range settings programming tool.....	26
Figure: 23 "Older" plotter settings programming tool	26
Figure: 24 CPA settings programming tool	27
Figure: 25 CPA settings programming tool 2	28
Figure: 26 Anchor Alert settings programming tool	29
Figure: 27 Anchor Alert settings programming tool 2.....	29
Figure: 28 Memory setting programming tool	30
Figure: 29 directory information of internal storage of the easyTRX3 for "Log_Data"	31
Figure: 30 Memory setting programming tool 2	32
Figure: 31 easyTRX3 external Mass Storage Device no longer mounted	32
Figure: 32 Formatting of internal memory programming tool.....	33
Figure: 33 easyTRX3 advanced WiFi settings	34
Figure: 34 WiFi not connected	35
Figure: 35 WiFi Networks.....	36
Figure: 36 WiFi Network password	36
Figure: 37 WiFi Network information	36
Figure: 38 WiFi connected to PC, Tablet, etc. (1).....	37
Figure: 39 WiFi configuration window and help page.....	37
Figure: 40 WiFi Access Point Configuration Rescan.....	38
Figure: 41 WiFi Access Point Configuration Apply	38
Figure: 42 WiFi Access Point Configuration Settings	39
Figure: 43 WiFi connected to PC, Tablet, etc. (2)	41
Figure: 44 Diagnostic screen programming tool	42
Figure: 45 Diagnostic screen programming tool.....	43
Figure: 46 GPS Status screen programming tool	46
Figure: 47 Sent data screen programming tool	47
Figure: 48 Received data screen programming tool	48
Figure: 49 Factory reset screen programming tool.....	49
Figure: 50 Pin-code page programming tool	50
Figure: 51 Firmware update screen programming tool	51
Figure: 52 WiFi connection screen programming tool	52
Figure: 53 WiFi connection screen programming tool 2.....	53

Table of Content

1	References.....	2
1.1	General Warning.....	2
1.2	Licensing (MMSI) for AIS Class B.....	2
1.3	Warnings and Precautions.....	2
1.4	Application Federal Network Agency.....	2
1.5	Approval Number BSH.....	3
1.6	Revision Level.....	3
1.7	Restrictions.....	3
2	Index of Abbreviations.....	3
3	Pictures/Sketches Overview.....	3
4	Scope of Delivery - what is in the box?.....	7
5	Brief description of the product "easyTRX3".....	8
6	Unique selling standard features of the AIS Class B easyTRX3.....	8
7	Connectors.....	9
7.1	Standard.....	9
7.2	Options.....	9
7.3	External Switches.....	10
7.3.1	CPA Alert.....	11
7.3.2	Anchor Alert.....	11
7.3.3	RX only.....	12
7.3.4	External signal generator.....	13
8	Preparations.....	14
8.1	Via USB Connection to PC/MAC/Laptop.....	15
8.1.1	Connection.....	16
8.1.2	Basic Setup.....	18
8.1.3	Advanced Settings.....	19
8.1.3.1	Interfaces.....	20
8.1.3.2	Baud rates of NMEA0183 Ports.....	20
8.1.4	Distance Filter.....	22
8.1.5	AIS-Transmitter - Silent mode.....	24
8.1.6	Long-range AIS / Satellite AIS.....	26
8.1.7	Alarm on Plotter.....	26
8.1.8	CPA Alert.....	27
8.1.9	Anchor Alert.....	28
8.1.10	Internal Memory.....	30
8.1.11	WiFi Configuration.....	34
8.1.11.1	Router Setup.....	35

8.1.11.2	AIS on mobile devices within the WLAN network of the router	40
8.1.11.3	Explanations	41
8.1.12	Diagnostics.....	42
8.1.12.1	Status.....	43
8.1.13	GNSS	45
8.1.13.1	Data	46
8.2	WiFi Connection to a Laptop.....	52
8.3	WiFi Connection and App via mobile terminal device	54
8.3.1	Functionality via App	59
8.3.1.1	Transmitter	59
8.3.1.2	Long-Range AIS/Satellite AIS	59
8.3.1.3	Data Routing/Data Configuration.....	60
8.3.1.4	Target Filtering.....	63
8.3.1.5	Flash Memory	64
8.3.1.6	Diagnostics.....	65
8.3.1.7	Anchor Alert	70
8.3.1.8	CPA Alarm.....	72
8.3.1.9	Sent Data	74
9	Modular Built-up.....	76
9.1	IS - integrated VHF antenna splitter	76
9.2	IGPS – integrated GPS antenna	76
9.3	N2K – integrated NMEA2000 module.....	76
9.4	WiFi - integrated WiFi module (optional)	77
9.5	DVBT - integrated frequency splitter for TV signal and FM radio (optional)	77
10	Installation of the easyTRX3 aboard.....	77
11	Technical Data	78
12	Circuit diagram proposal	80
13	Troubleshooting	81
14	Error Codes/Warning Codes.....	82
15	Maintenance.....	83
16	Contact and support information	83
17	License agreement	83
18	Warranty	84
19	Warning	84
20	Notices.....	85

4 Scope of Delivery - what is in the box?

①	AIS Class B easyTRX3
②	Connection Cable 18-pins / Power (ca. 200 cm)
③	Connection Cable easyTRX3 to VHF Radio (ca. 100 cm)
④	USB Cable (ca. 180 cm)
⑤	Quick Instruction User Guide (→ internal storage) Programming Software for Windows® PC und Apple® Mac (→ internal Storage)
⑥	WiFi - Antenna (depending on product variant)
⑦	DVB-T2 Cable pack (depending on product variant)

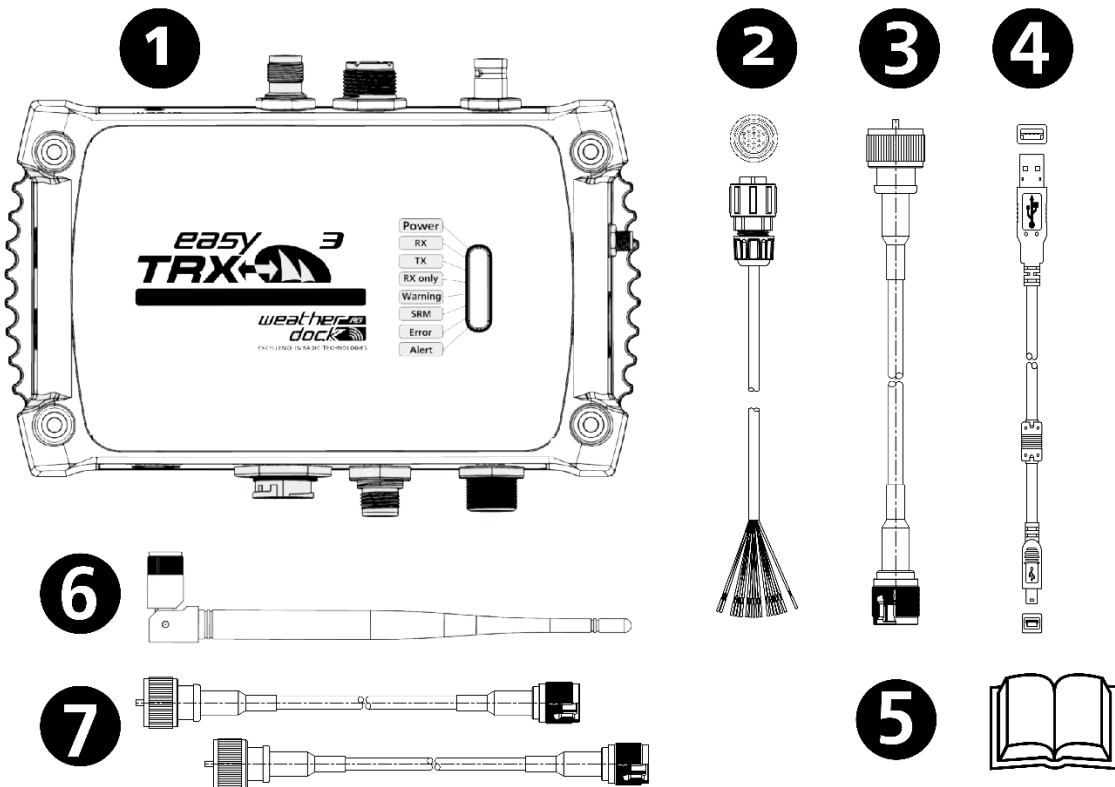

Figure: 1 Box content

5 Brief description of the product “easyTRX3”

- The easyTRX3 is an approved AIS Class B SOTDMA transceiver, designed and manufactured by Weatherdock AG in Germany
- The unit easyTRX3 does have a lot of advantages against the existing competition products, which are available in the market, which are the integrated splitter to use the existing VHF antenna and the integrated GPS. Moreover, there are a lot of additional modules which can be simply added to the unit.
(See details under: chapter 9 – Modular Built-up)

6 Unique selling standard features of the AIS Class B easyTRX3

The “USP’s” which are added in addition to the normal Class B AIS transponder features:

- Integrated GPS antenna and GPS processor (No need for external GPS Antenna!)
- Integrated VHF radio splitter. Just connect the easyTRX3 to the existing VHF antenna from the VHF radio.
- Additional USB-Port
- NMEA 0183
- NMEA 2000
- 4800, 38400 or 115200 baud rates select with software
- Operating display with 8 LEDs
- CPA-Alarm even without plotter connected
- Anchor-Alarm even without plotter connected
- Enlarged voltage input 10-32V DC
- Internal storage for Blackbox employment
- Multiplexer integrated
- AIS-S.A.R.T. Alarm trigger, even without plotter connected
- 72 channel GNSS for GPS, Glonass, (number of concurrent GNSS: 2)
- Router functionality
- WiFi for up to 40 user

7 Connectors

7.1 Standard

- Integrated VHF antenna splitter with connection plug for VHF antenna (SO239) and adapter cable to VHF radio (TNC)
- External GPS antenna (BNC)
- USB Port (Mini-B)
- NMEA2000 Output port (MicroC)
- Three equal NMEA0183 ports for IN/OUT

7.2 Options

Depending on the product variant there are additional plugs for:

- WiFi (SMA if option is added for then enclosed antenna)
- DVB-T2 (BNC) and FM-Radio (BNC)
- LAN (RJ45)

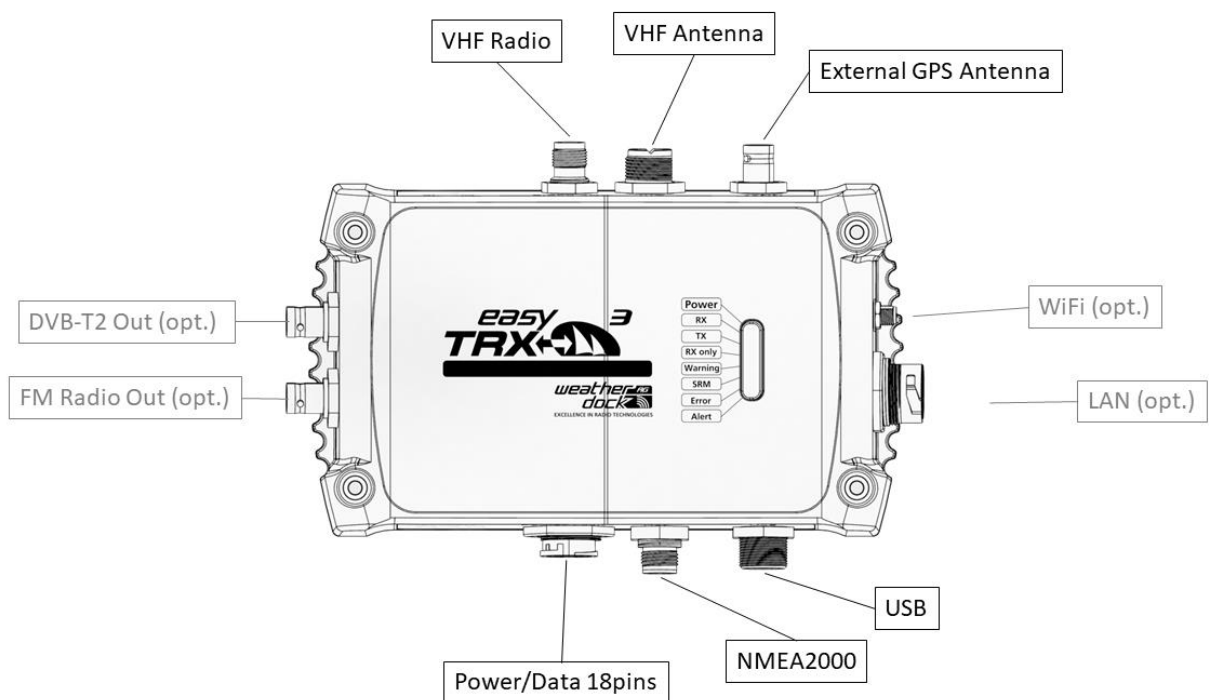

Figure: 2 Connectors

7.3 External Switches

Connecting possibilities

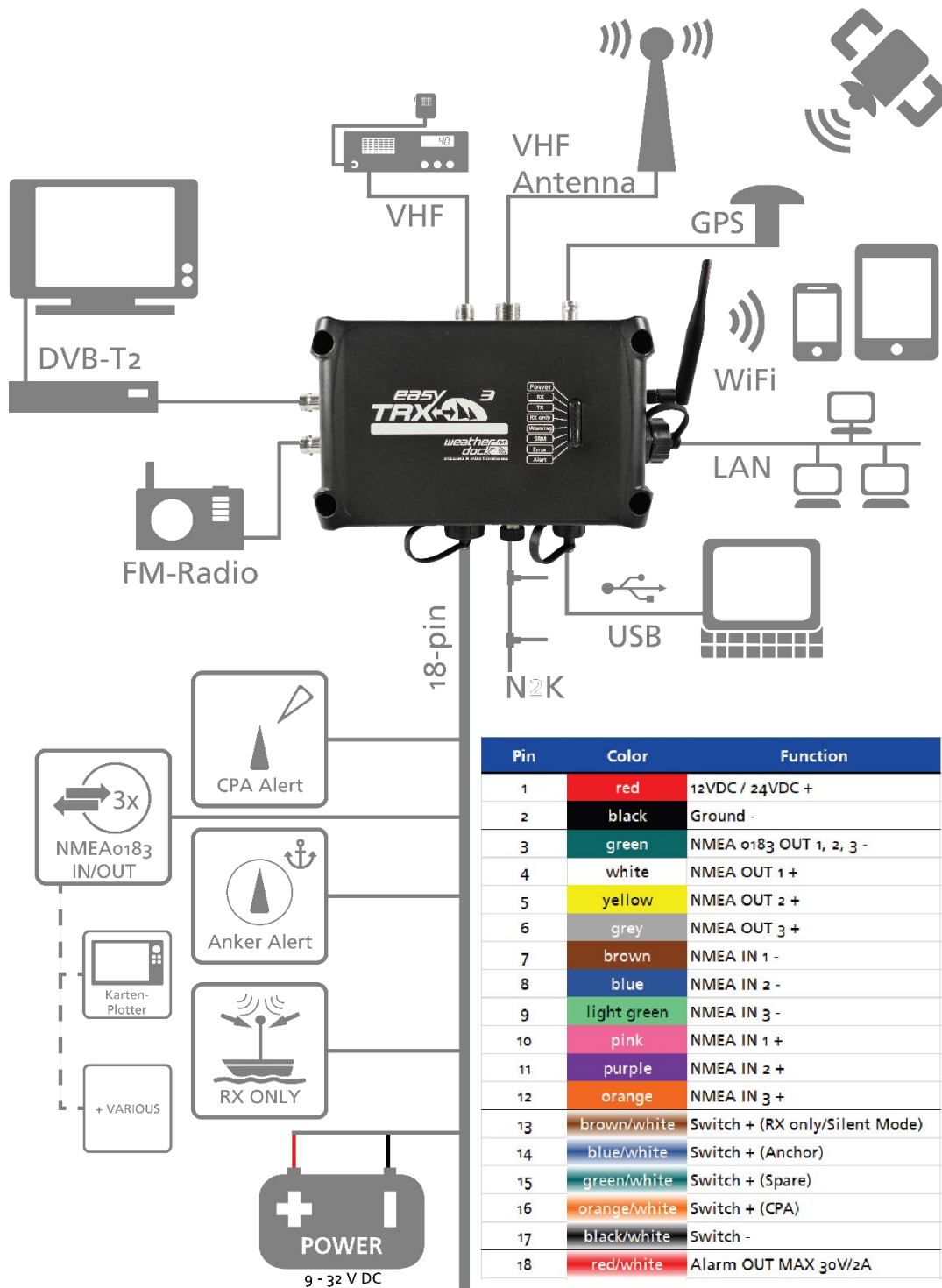

Figure: 3 Connection possibilities and cable colours

7.3.1 CPA Alert

To keep the daily usage of this functionality as easy as possible, you can connect an external switch and an external signal generator (e.g. a horn, see chapter 7.3.4).

External Switch

Out of the 18-pin cable harness please connect cables

- "16 / Orange_White / Switch+ (CPA)" and
- "17 / Black_White / Switch-"

with the corresponding pole of your switch. According to your software settings you are able to activate or deactivate this CPA functionality.

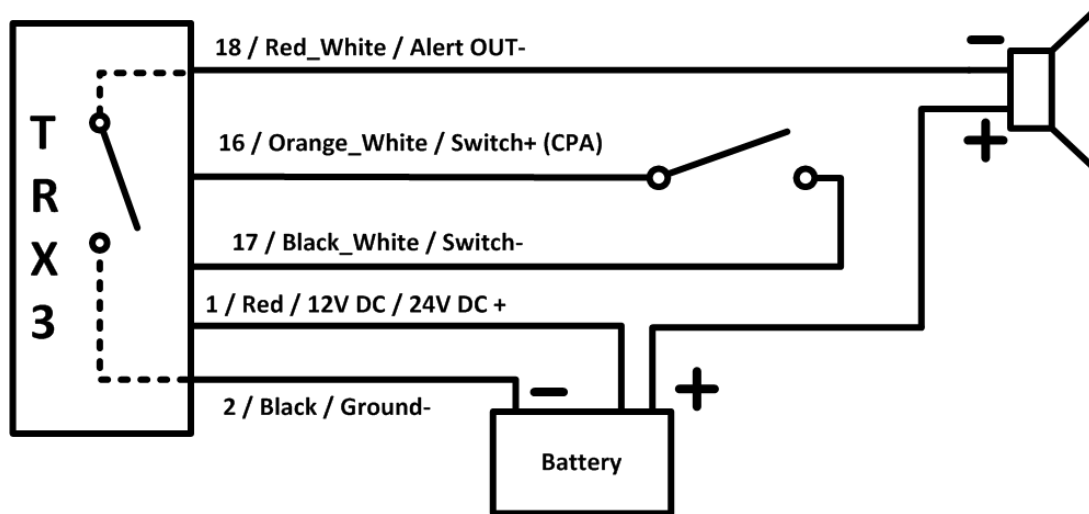

Figure: 4 CPA Alert connection sketch

7.3.2 Anchor Alert

To keep the daily usage of this functionality as easy as possible, you can connect an external switch and an external signal generator (e.g. a horn, see chapter 7.3.4).

External Switch

Out of the 18-pin cable harness please connect cables

- "14 / Blue_White / Switch+ (Anchor)" and
- "17 / Black_White / Switch-"

with the corresponding pole of your switch. According to your software settings you are able to activate or deactivate this Anchor alert functionality.

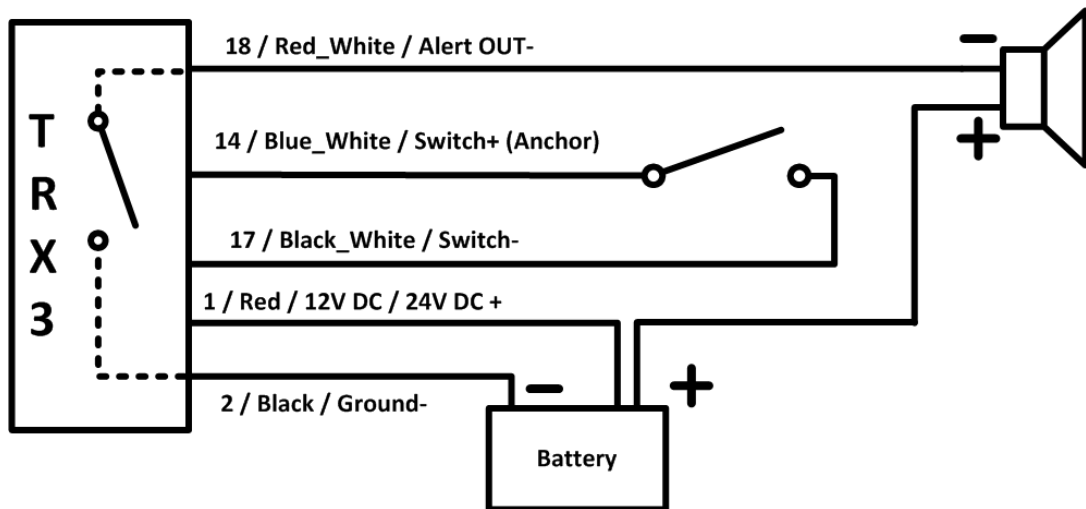

Figure: 5 Anchor Alert connection sketch

7.3.3 RX only

External Switch

Out of the 18-pin cable harness please connect cables

- "13 / Brown_White / Switch+ (RXonly)" and
- "17 / Black_White / Switch-"

with the corresponding pole of your switch. According to your software settings you are able to activate or deactivate this functionality.

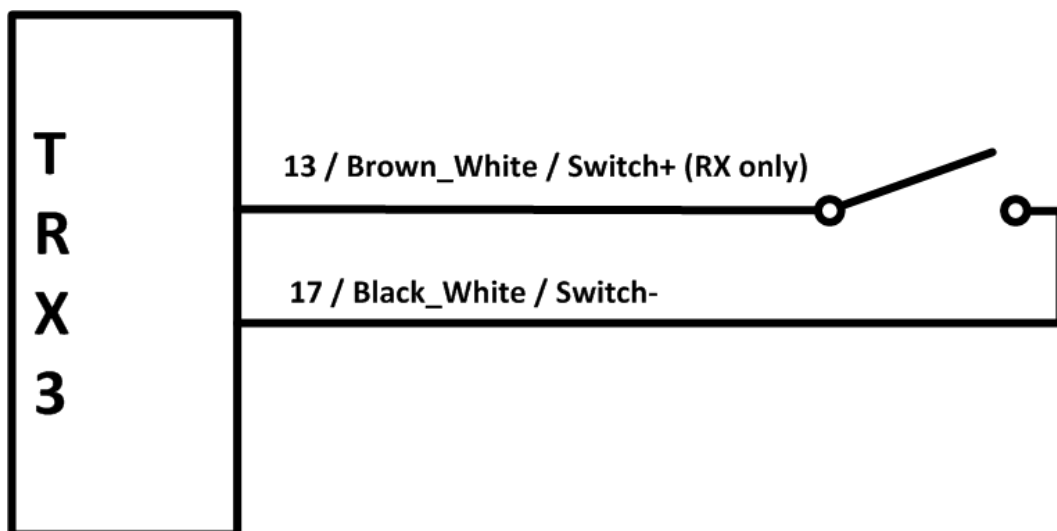

Figure: 6 RX only

7.3.4 External signal generator

Out of the 18-pin cable harness please connect cable "18 / Red_White / Alert OUT-" with the corresponding pole of the signal generator. Due to the already given power supply of the easyTRX3 via cable "2 / Black / Ground-" and "1 / Red / 12V DC / 24V DC +" you just have to connect the signal generator "+" pole to the power supply to close the circuit.

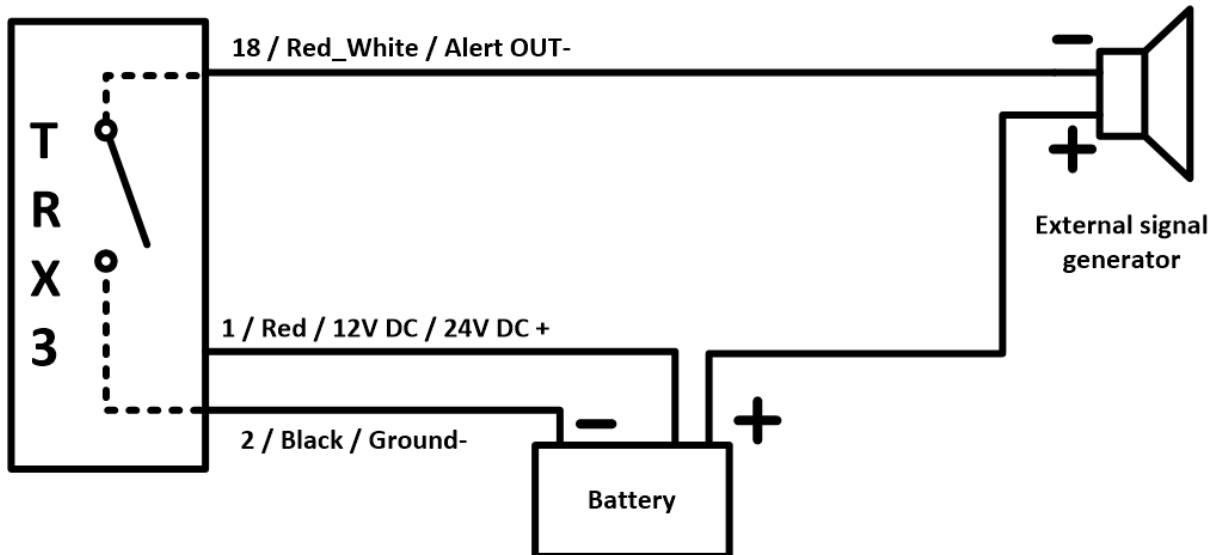

Figure: 7 External signal generator connection sketch

8 Preparations

Configuration and Programming of the easyTRX3 can be done at home easily. You just have to connect the USB cable, which is contained in the box, to your computer. There is no need for an external power supply of the easyTRX3 for the programming of the unit. Power is given via USB. Please note the following hint:

The easyTRX3 is not able to receive or transmit AIS data during USB connection. GPS and WiFi will also do not work.



Figure: 8 Base connection by USB for programming

Functionality	5v DC USB	12/24V DC	5v DC 12/24V DC
Access to PDF User Guide	✓	✗	✓
Access to programming software	✓	✗	✓
Read-out of the stored AIS data	✓	✗	✓
AIS Transmitting	✗	✓	✓
AIS Receiving	✗	✓	✓
N2K Functionality	✗	✓	✓
GPS	✗	✓	✓
WiFi	✗	✓	✓

Figure: 9 Feature functionality while connected by USB for programming

Access to the internal storage of the easyTRX3 is only possible via USB cable connection.

Important:

As soon as you want to use the WiFi functionality of your easyTRX3, you definitely need 12V DC or 24V DC power supply. It is not possible to run WiFi with only USB connection.

Programming-Software for easyTRX3

With the basic settings you are able to create the fundamental assumption to use the easyTRX3 within the AIS technology.

There are different ways how to program:

8.1 Via USB Connection to PC/MAC/Laptop

To program your specific vessel data, please connect the USB cable with your computer. Windows Explorer or iOS Finder will automatically rout the easyTRX3 as an external mass storage device (MSD).

In the folder which fits most to your computer system you will find the “.exe” file of the programming tool software.

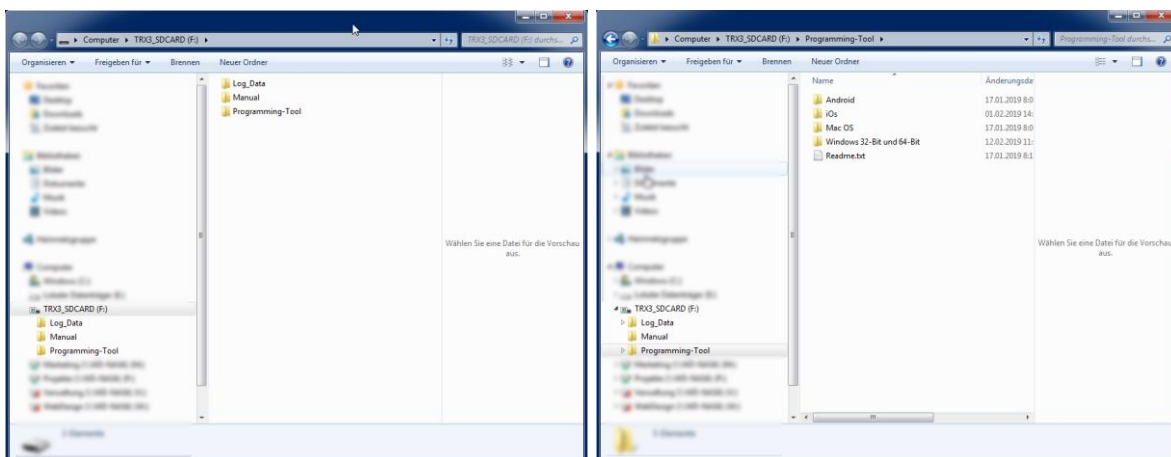

Figure: 10 directory information of internal storage of the easyTRX3

Please copy this file on your computer and install the software locally. After starting the software you will see the start screen.



Figure: 11 start screen programming software

Click on "Connection", to select and to establish the connection with the easyTRX3.

8.1.1 Connection

The connection via USB cable is pre-selected by default.

Select the COM-Port where the USB cable is plugged. Maybe you have to press the "re-fresh" button if the right port is not in the drop-down-list.

Once you have chosen the right COM-port, please press "connect". Now the connection is established. In the lower window you can see incoming data rows.

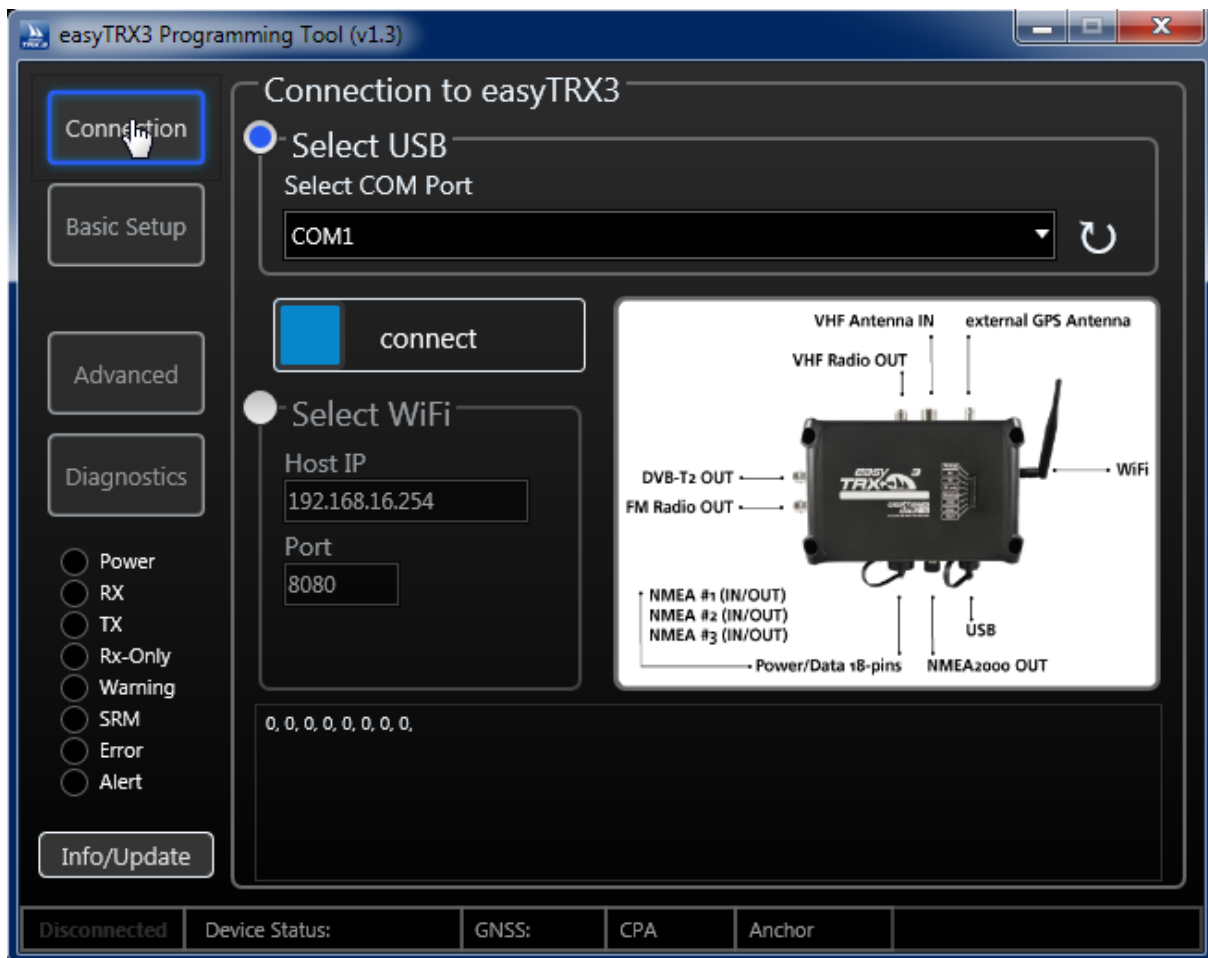

Figure: 12 Connection screen programming software

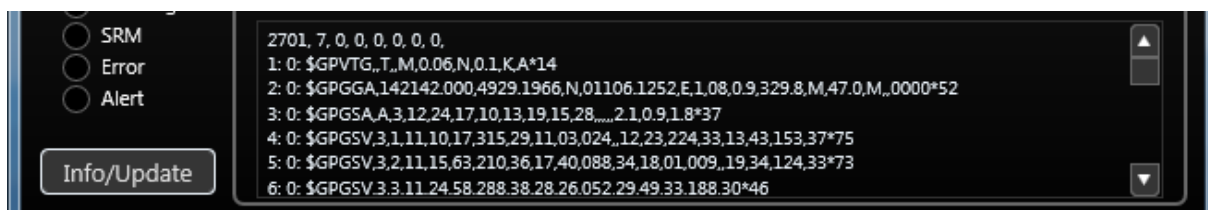

Figure: 13 data flow screen connection software

The software automatically switches over to “Basic Setup”.

8.1.2 Basic Setup

Here you can enter your static vessel data for transmission into the AIS system. As an example, here "WD MK", is used as ship name and "1234567" as call sign as well as a random MMSI number.

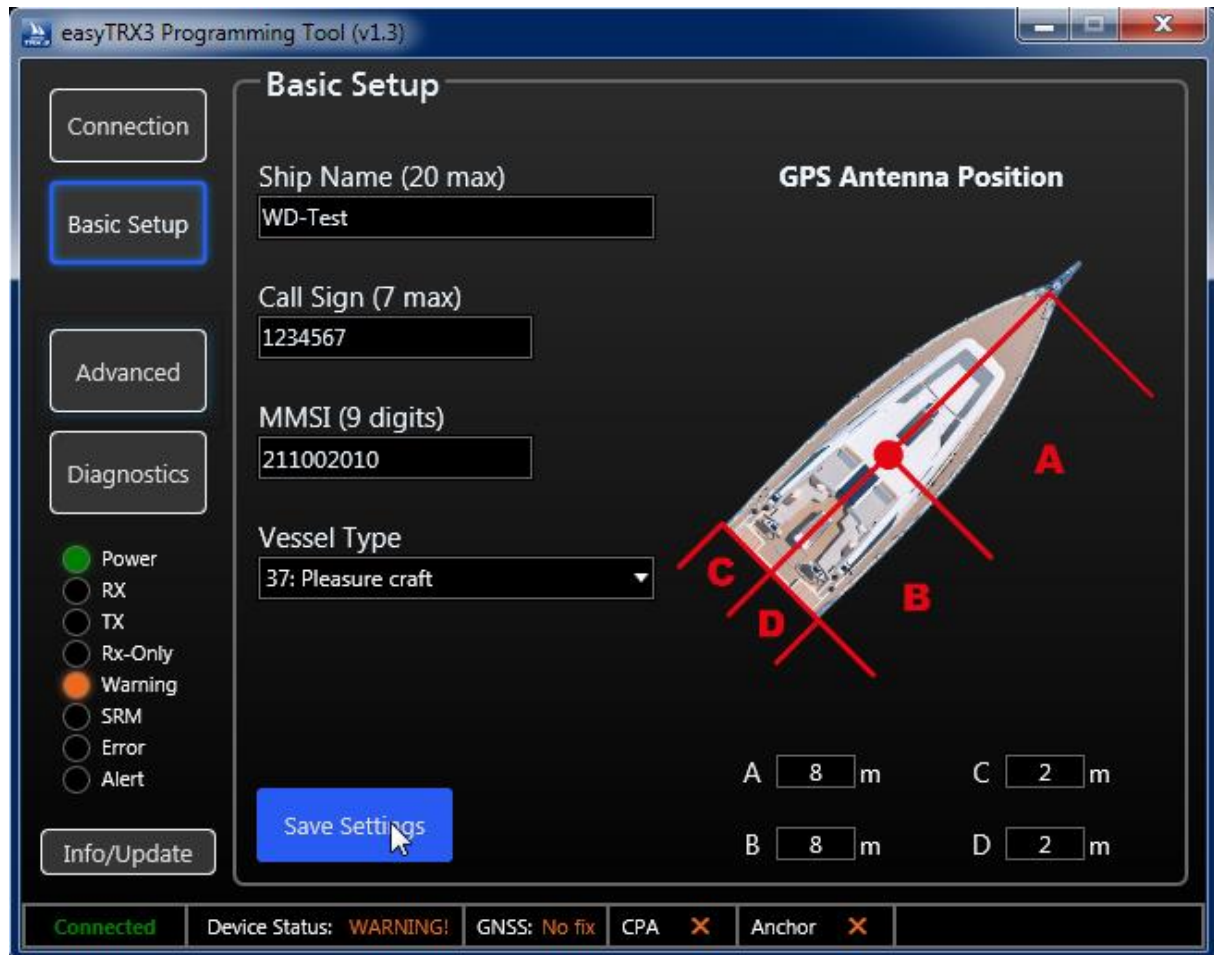

Figure: 14 Basic setup screen programming software

- Ship name
- Call Sign
- MMSI (if you already having a MMSI for VHF radio, this MMSI is now used for the entire ship)
 - Attention:
 - transmission is only possible with entered MMSI number
 - only one MMSI can be used (no way of entering a second, different MMSI)
- As confirmation you have to enter your MMSI number a second time
- Select your type of vessel from the drop-down-list
- define the position of your GPS source aboard by entering data into the cells A/B/C/D
- After you are finished please press „Save Settings“
- As a confirmation a new window is popping-up which you can close by pressing „OK“.

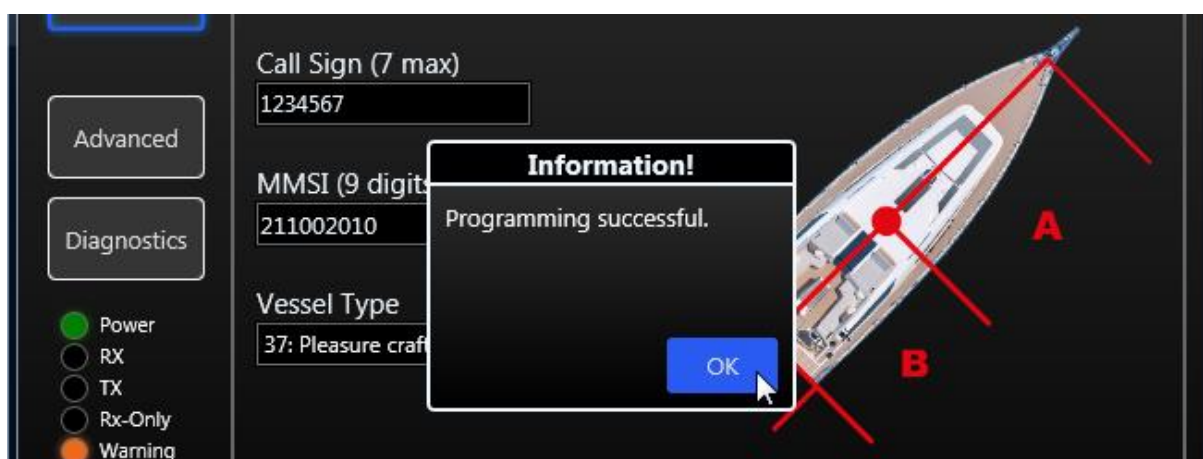

Figure: 15 Basic setup screen programming softwarez

With these few settings your AIS Class B unit easyTRX₃ is now ready for receiving and transmitting AIS data.

As default you can connect your chart plotter via NMEA0183 connection with 38400 baud data rate at NMEA1 OUT or NMEA2 OUT.

In case that you additional want to connect a VHF radio, please take NMEA3 OUT which is pre-set on 4800 baud data rate as default.

If you want to integrate the easyTRX₃ into your NMEA2000 board net, let's go. AIS and GPS data are forwarded via N2K OUT.

In the event that these basic settings are 100% fitting your situation, please press "Connections" for disconnection and shut down the program afterwards.

In chapter 10 you will find information about "Installation".

If you have to change the default-settings to fit your situation, please press "Advanced".

8.1.3 Advanced Settings

Within this part of the programming software you will get a view into the possible deeper settings for special customization of the easyTRX₃ unit.

After pressing "Advanced" you first see the following screen with sub-chapters for advanced settings

- Interfaces
- AIS-Transmitter
- CPA
- Anchor
- Flash-Memory
- WiFi

As followed you see the default settings for „interfaces“.

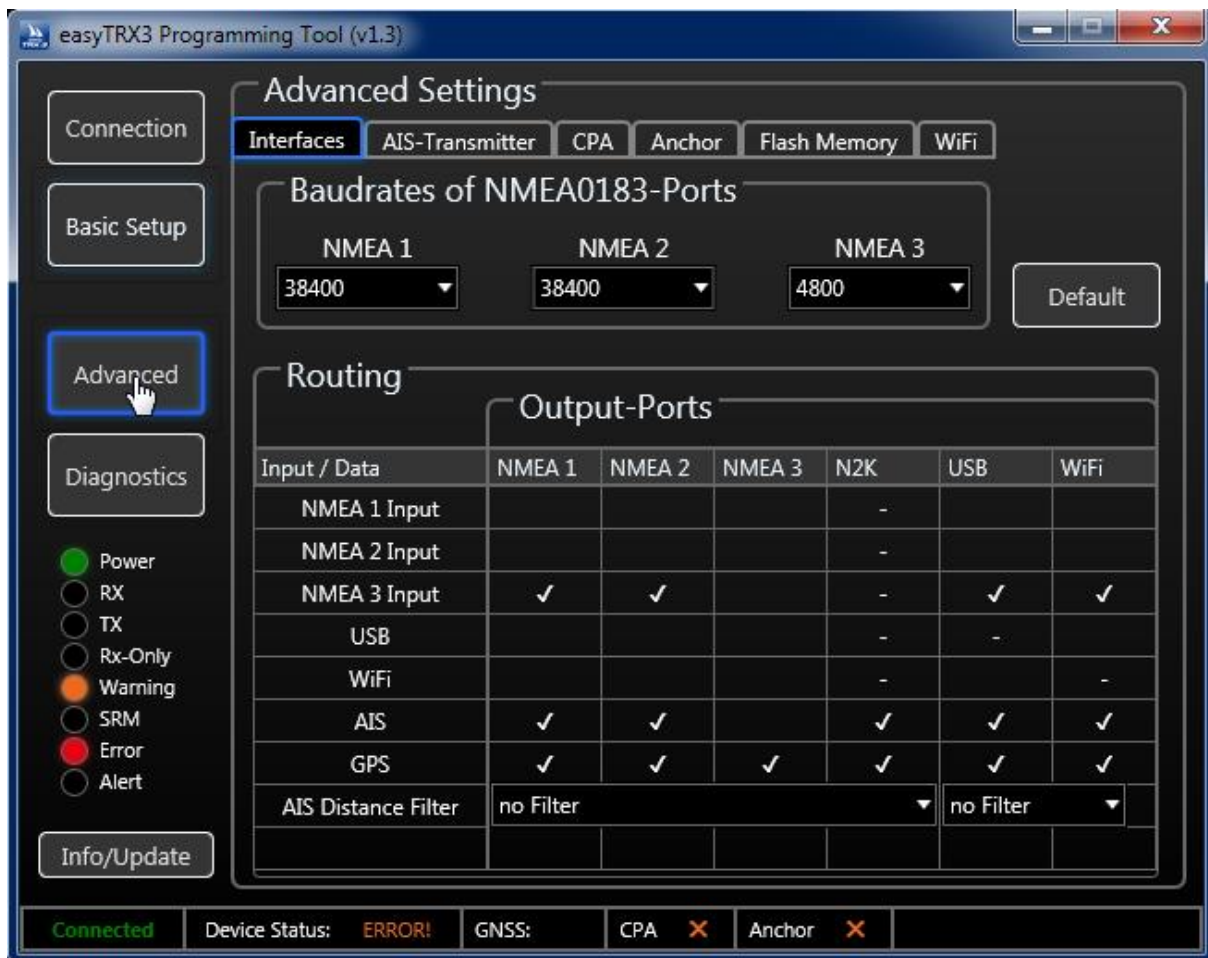

Figure: 16 Advance setting screen programming software

8.1.3.1 Interfaces

Here you can step out of the default settings for personal adjustments. You can define which external devices will be connected for IN and OUT to the easyTRX3 and which baud rate has to be used on each port (NMEA1, NMEA2, NMEA3, WiFi, USB and N2K).

8.1.3.2 Baud rates of NMEA0183 Ports

At this point it is choosable with which baud rate the NMEA ports have to work with. You can select between 4800 baud, 38400 baud or even 115200 baud. It is possible to set different baud rates for the different ports.

Important to know:

Each port runs with similar data rate for IN and OUT. This means that it is possible to connect different devices for IN and OUT at the same port, but the baud rate of these connected devices has to be similar.

The following matrix (manufacturer default) is for configuration of device routing. Here you can decide on which port data will be feeded IN and on which port these data have to be forwarded OUT to connected devices.

Change the default routing by clicking into the different cells to display your personal setup aboard.

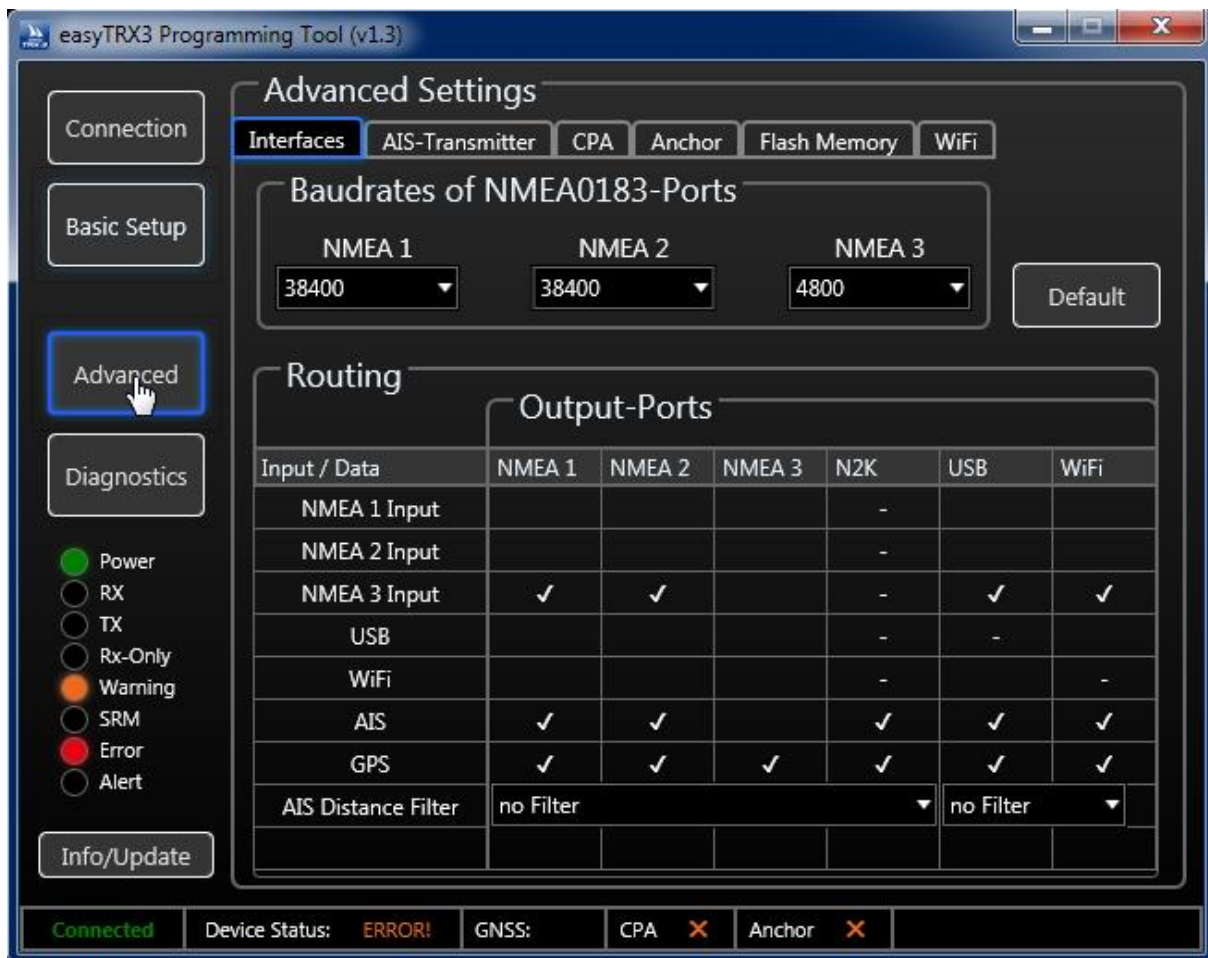

Figure: 17 Advance setting screen programming software 2

Additional you can select on which port AIS and GPS data, received from the easyTRX3, have to be forwarded OUT to connected devices.

Example of manufacturer default:

Baud rate:

- NMEA1: 38400 Baud for IN/OUT
- NMEA2: 38400 Baud for IN/OUT
- NMEA3: 4800 Baud for IN/OUT

Routing:

GPS data were forwarded to

- NMEA1 – e.g. chart plotter
- NMEA2 – e.g. chart plotter
- NMEA3 – e.g. VHF radio
- N2K – board network
- USB – e.g. Laptop or PC
- WiFi – e.g. Tablet or other terminal device

AIS data were forwarded to

- NMEA1 – e.g. chart plotter
- NMEA2 – e.g. chart plotter
- N2K – board network

- USB – e.g. Laptop or PC
- WiFi – e.g. Tablet or other terminal device

INPUT data on NMEA3 (e.g. log or wind) were forwarded to

- NMEA1 – e.g. chart plotter
- NMEA2 – e.g. chart plotter
- USB – e.g. Laptop or PC
- WiFi – e.g. Tablet or other terminal device

Once you found the best personal setting, please press “Save”.

8.1.4 Distance Filter

The above shown screen copy also displays an activated distance filter. By using this functionality you will be able to un-show AIS objects which are out of the selected distance range. This can be useful in areas with high traffic volume to reduce the total amount of displayed objects on your screen.

The distance filter can be used independently for NMEA and/or USB and WiFi. It is also possible to use only one filter out of these two.

After you found your settings, please press “Save”.

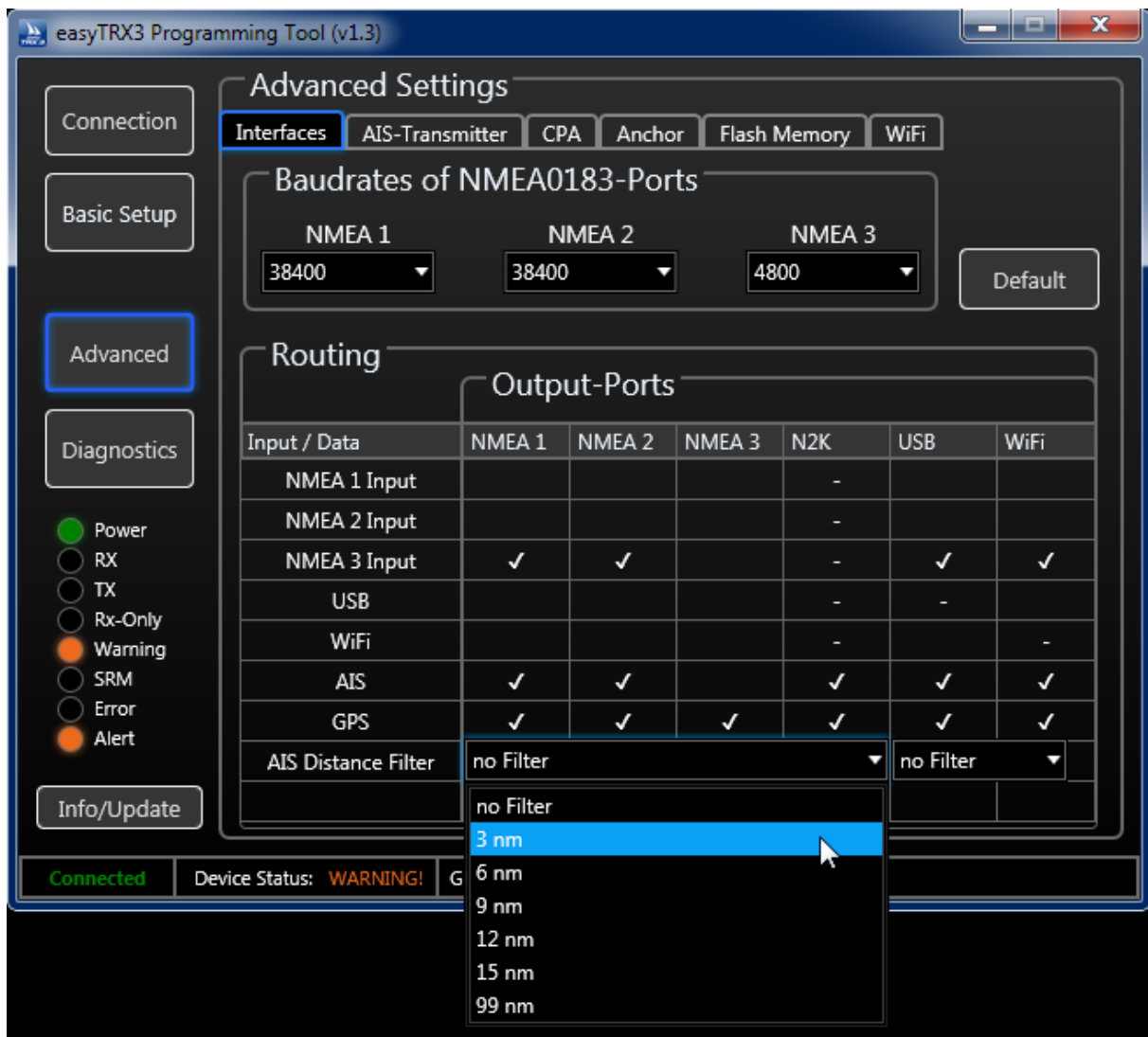

Figure: 18 Distance Filter screen programming software

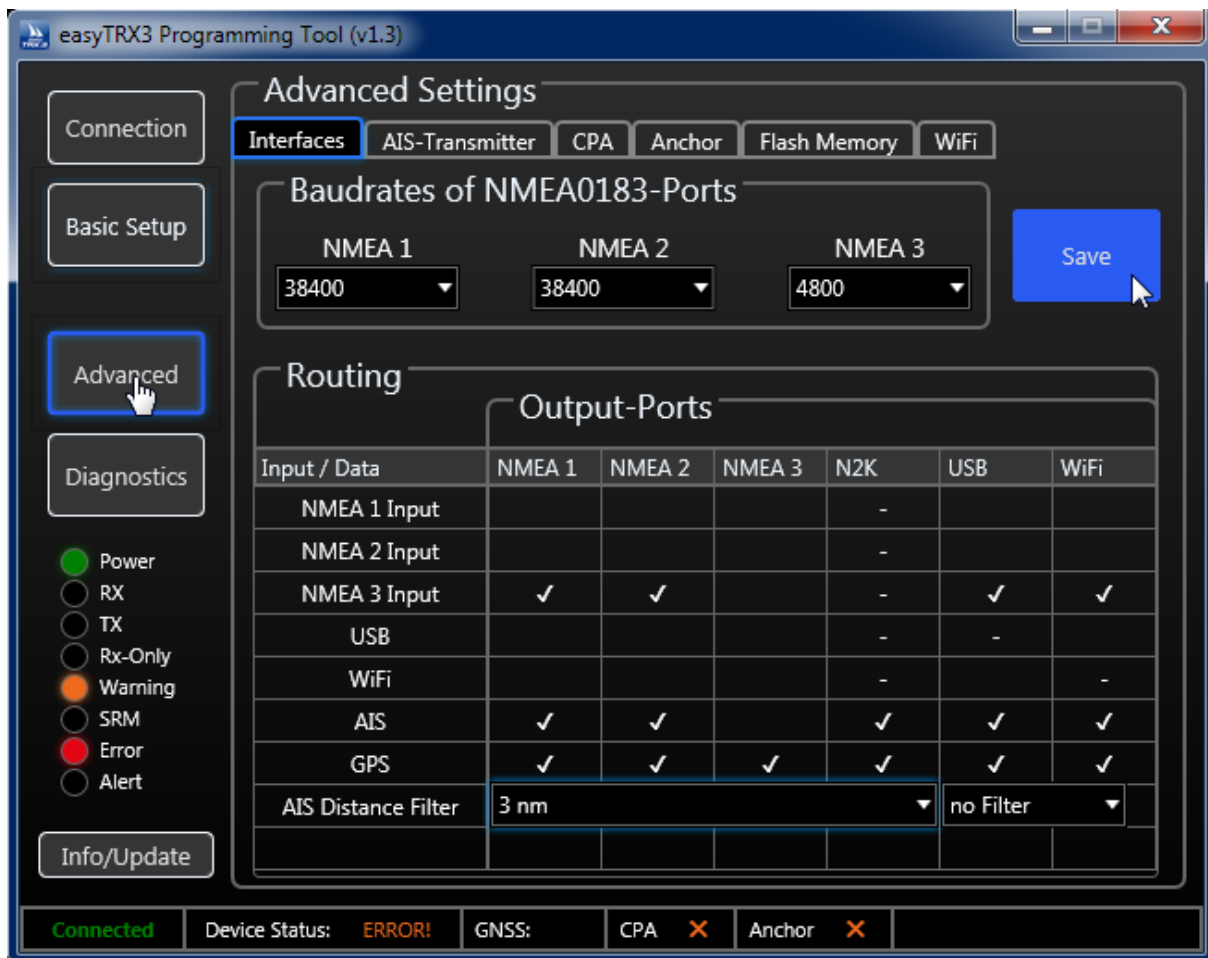

Figure: 19 Save screen programming software

8.1.5 AIS-Transmitter - Silent mode

This chapter is about transmitting and receiving. It is possible to shut down the broadcasting functionality by setting the easyTRX3 into pure receiving mode (RXonly).

Press "OFF" at "AIS Transmitter" to switch into "RXonly" mode.

On the left part of the screen you see the "RXonly" control-LED glowing immediately. As a confirmation a small pop-up window appears which you can close by pressing "OK".

You can terminate the programming by stepping back "Connection" and pressing "disconnect", or you go ahead with other special settings.

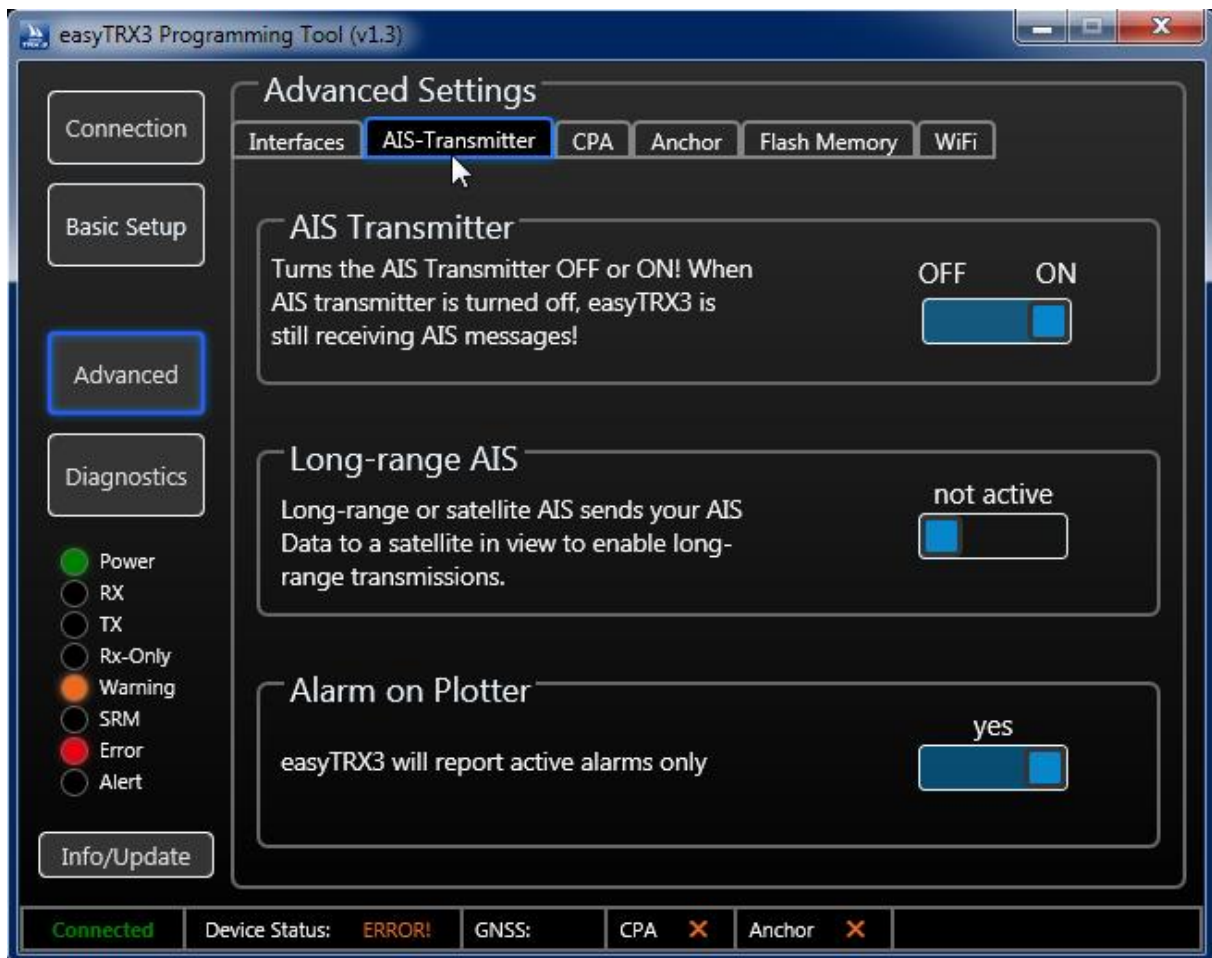

Figure: 20 AIS transmitter settings programming software

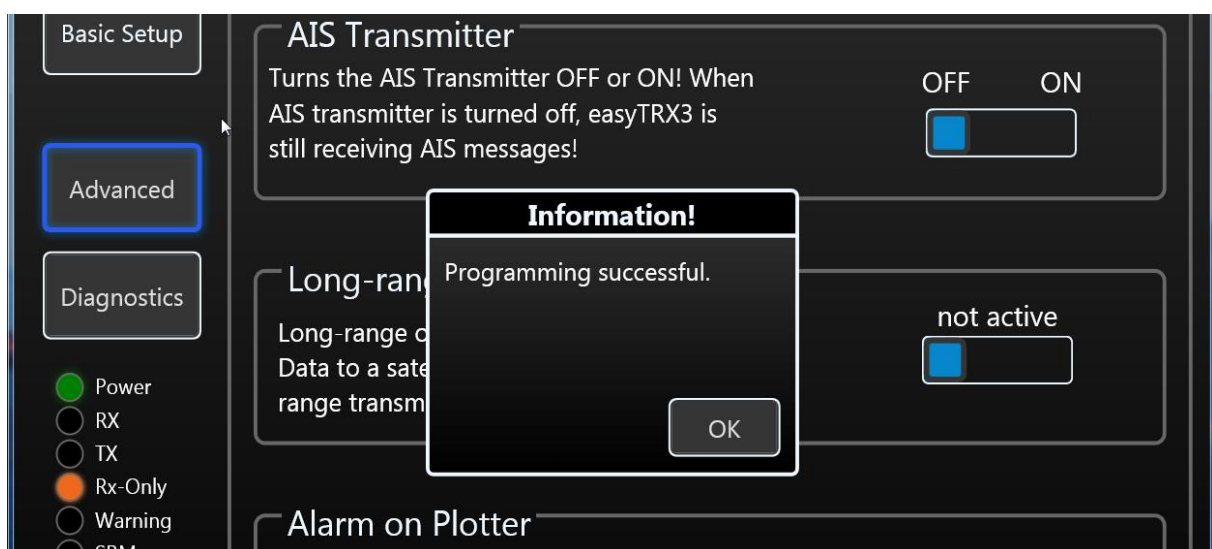

Figure: 21 AIS transmitter settings programming software 2

8.1.6 Long-range AIS / Satellite AIS

Due to IMO international regulations this functionality is deactivated by default. Long-range AIS is designed for sea-going vessels which are getting out of the range of coastal base stations. Once the Long-range AIS is activated, every 3 minutes a position report is send out to AIS satellites on special frequencies. The satellites will redirect the received report to coastal base stations. This enables the persistent onshore visibility of vessels on Trans-Atlantic-Trips.

By entering the receiving range of a coastal base station with activated long-range AIS, it might be possible, that the base station shuts down your functionality automatically because it is permitted in this area. Please inform by yourself in case of using long-range AIS. Once leaving the range of the base station, and the long-range AIS was activated before the automatic shutdown, the easyTRX3 will re-activate automatically.

As long as you are not subscribed for satellite data, the long-range AIS position reports are not shown at Vesseltracker.com or Marinetrassic. Vice versa there are no additional costs for you if the functionality is activated.

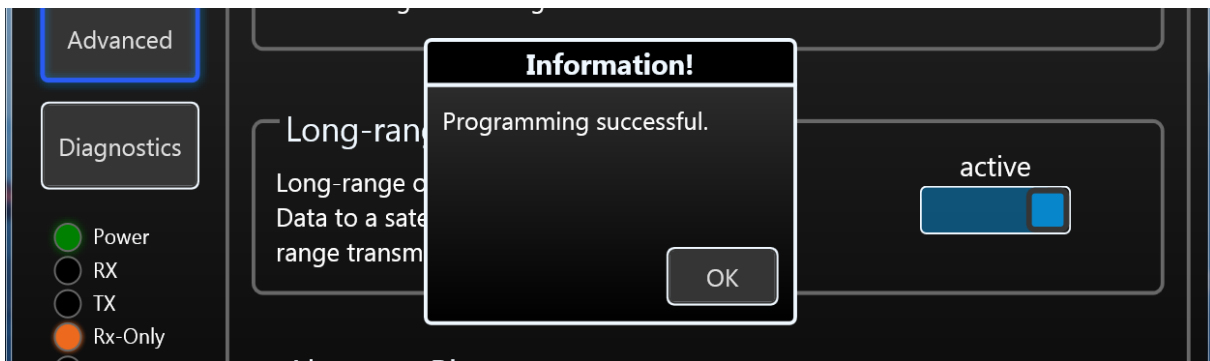

Figure: 22 Long-range settings programming tool

8.1.7 Alarm on Plotter

By default, this functionality is active. The reason for this is the self-test of the easyTRX3, which is done every 60 seconds. As a result of these self-tests, information like for example "GPS antenna not working / no reception" are send to the chart plotter.

It might be possible that these self-test information cause to misunderstandings and false alerts on elder chart plotter, due to incompatibility.

If this happens to you, you can deactivate this functionality by pressing "NO".

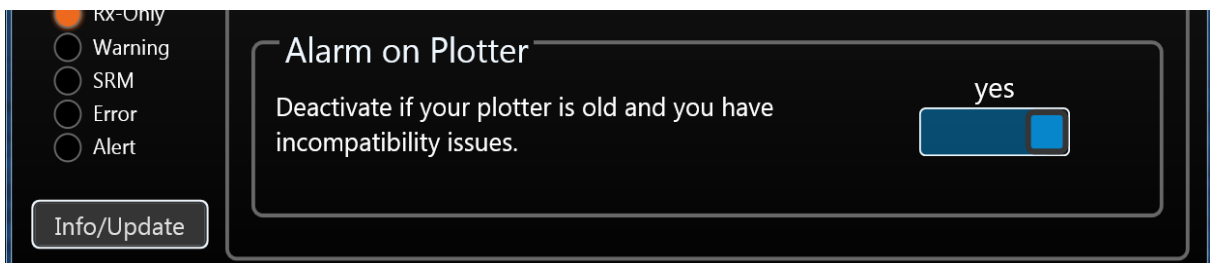

Figure: 23 "Older" plotter settings programming tool

8.1.8 CPA Alert

The CPA (Closest Point of Approach) alert functionality was developed to avoid collisions due to low visibility at night or bad weather conditions.

You can create your own "safety area" around your vessel by activating time- and distance settings.

Usually CPA settings will be done at the chart plotter. But the chart plotter has to be switched on all the time during the trip to keep the CPA functionality running. This might cause to a power supply problem aboard because chart plotters often need a lot of power. But during a long-term-trip it is absolutely needful to reduce power consumption to a minimum.

The big advantage of the easyTRX3 is that it has got an own internal CPA functionality and the chart plotter doesn't need to be switched on. All incoming AIS position reports will be investigated regarding the CPA settings done in this programming tool. In event of receiving a position report within the self-defined "safety area" which means potential collision, the Alert LED starts to glow.

To get the daily use of this functionality as convenient as possible, please take a look back to chapter 7.3 "External switches – connecting possibilities" how to use switches and external signal generators.

Please keep in mind that a switch, connected via the 18-pin cable harness (hardware), always takes priority over software programming-settings.

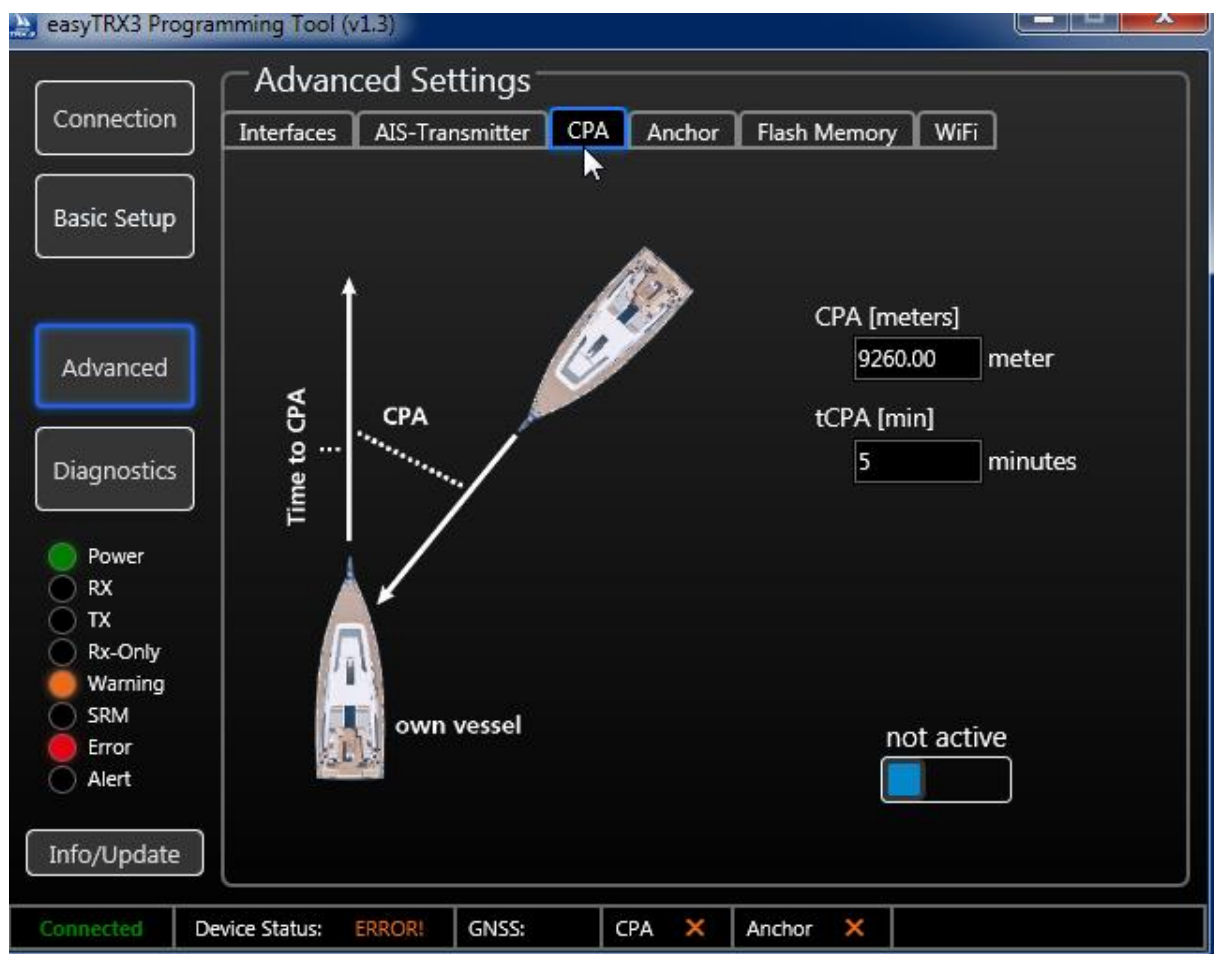

Figure: 24 CPA settings programming tool

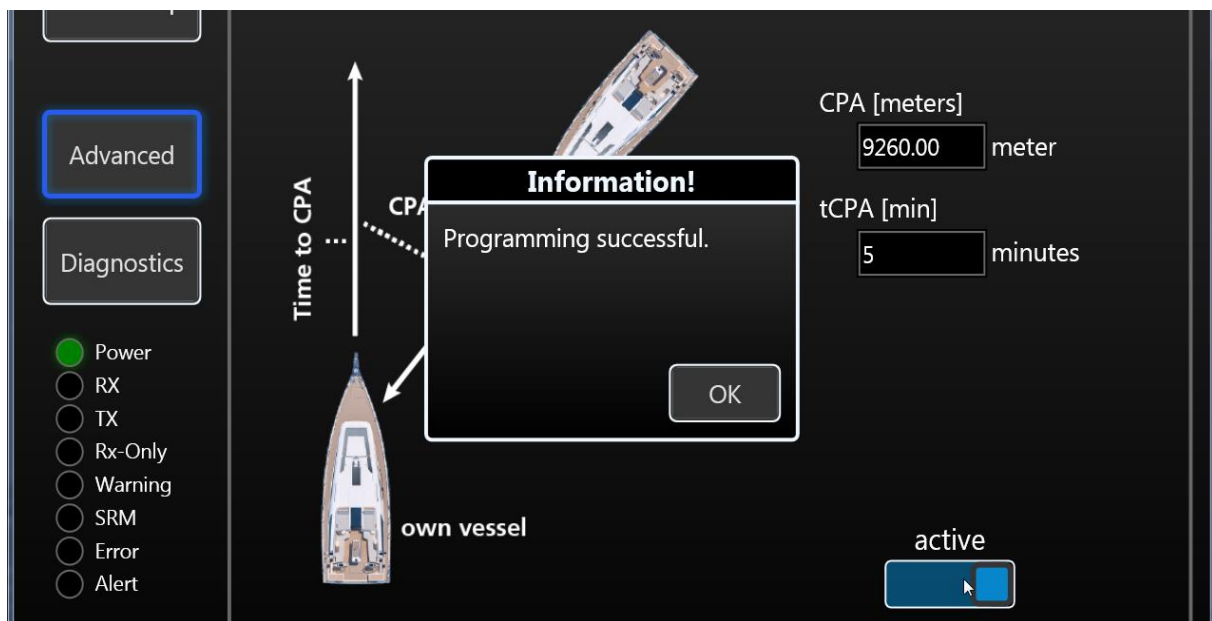

Figure: 25 CPA settings programming tool 2

After you have activated this functionality, a small confirmation window is coming-up which you can close by pressing "OK".

8.1.9 Anchor Alert

Here it is possible to create a kind of „anchor watch“ functionality by software which is deactivated by default.

You can set a distance as a radius around your anchor position. The radius to set is depending on the sway at anchor of your vessel in wind and current and on the length of your given anchor chain. Within this radius no alert has to be triggered. Once the radius line was step-over, the Alert LED starts to glow.

To get the daily use of this functionality as convenient as possible, please take a look back to chapter 7.3 "External switches – connecting possibilities" how to use switches and external signal generators.

Please keep in mind that a switch, connected via the 18-pin cable harness (hardware), always takes priority over software programming-settings.

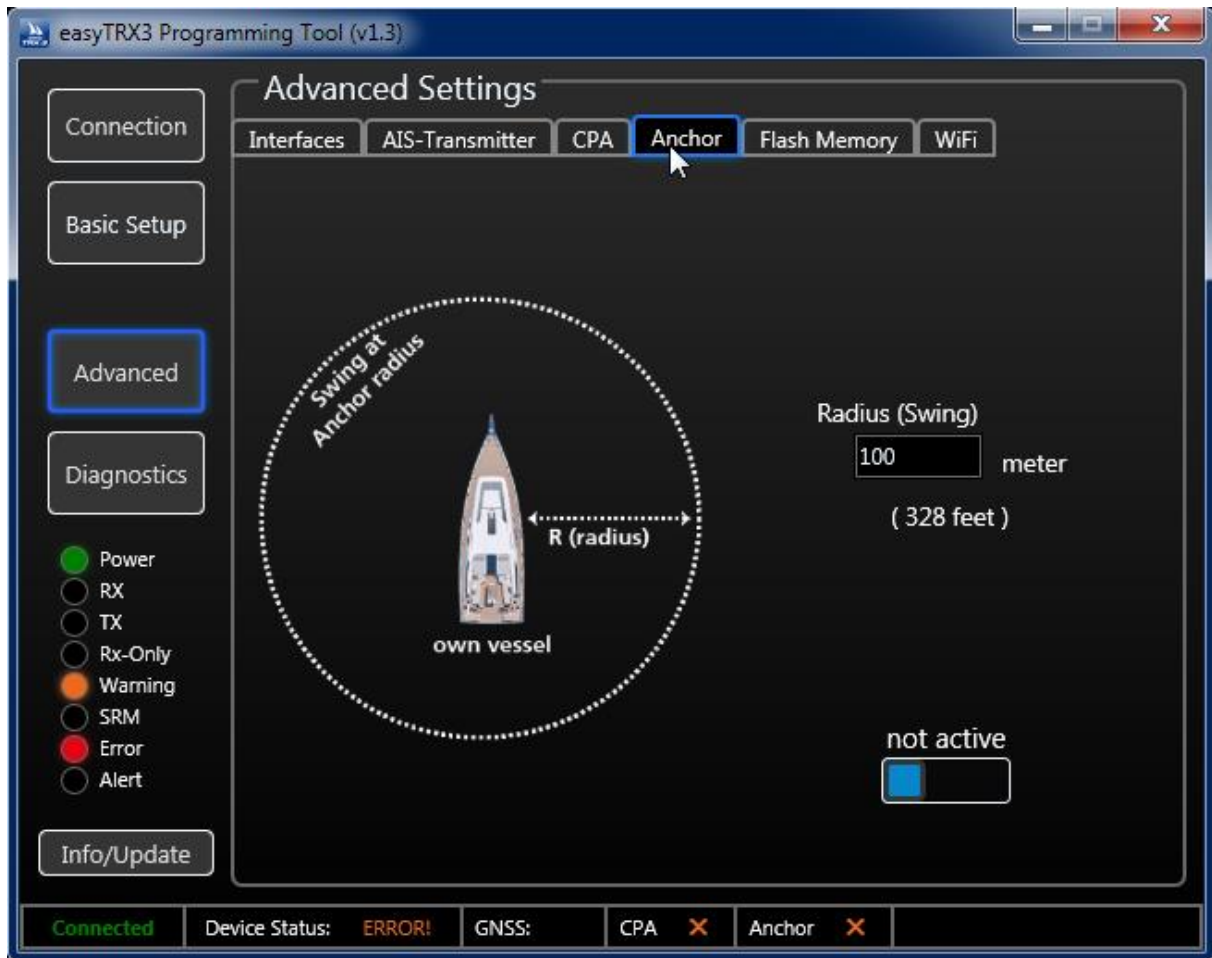

Figure: 26 Anchor Alert settings programming tool

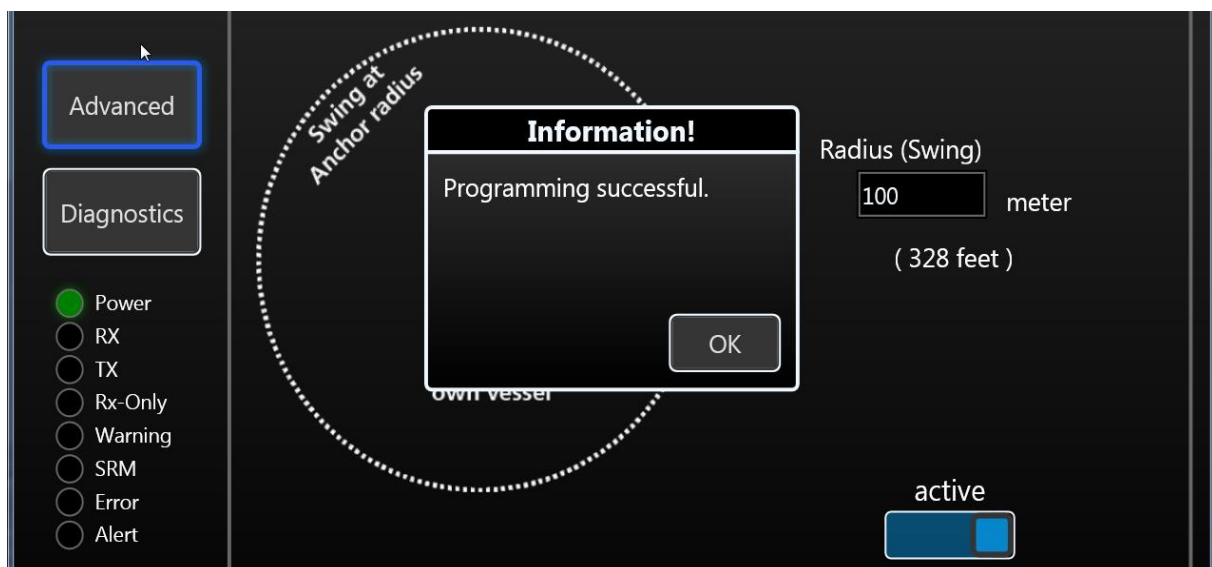

Figure: 27 Anchor Alert settings programming tool 2

After you have activated this functionality, a small confirmation window is coming-up which you can close by pressing "OK".

8.1.10 Internal Memory

The easyTRX3 default configuration by factory setting has got deactivated AIS and GPS data logging functionality. The unit is set in that way, that the internal memory works as a directory disk drive at your computer. This is good, because from there you can download the programming tool as well as the manual. But, by means of that factory setting an AIS Data Logging is de-activated.

If you want to log your AIS data, please see the below description

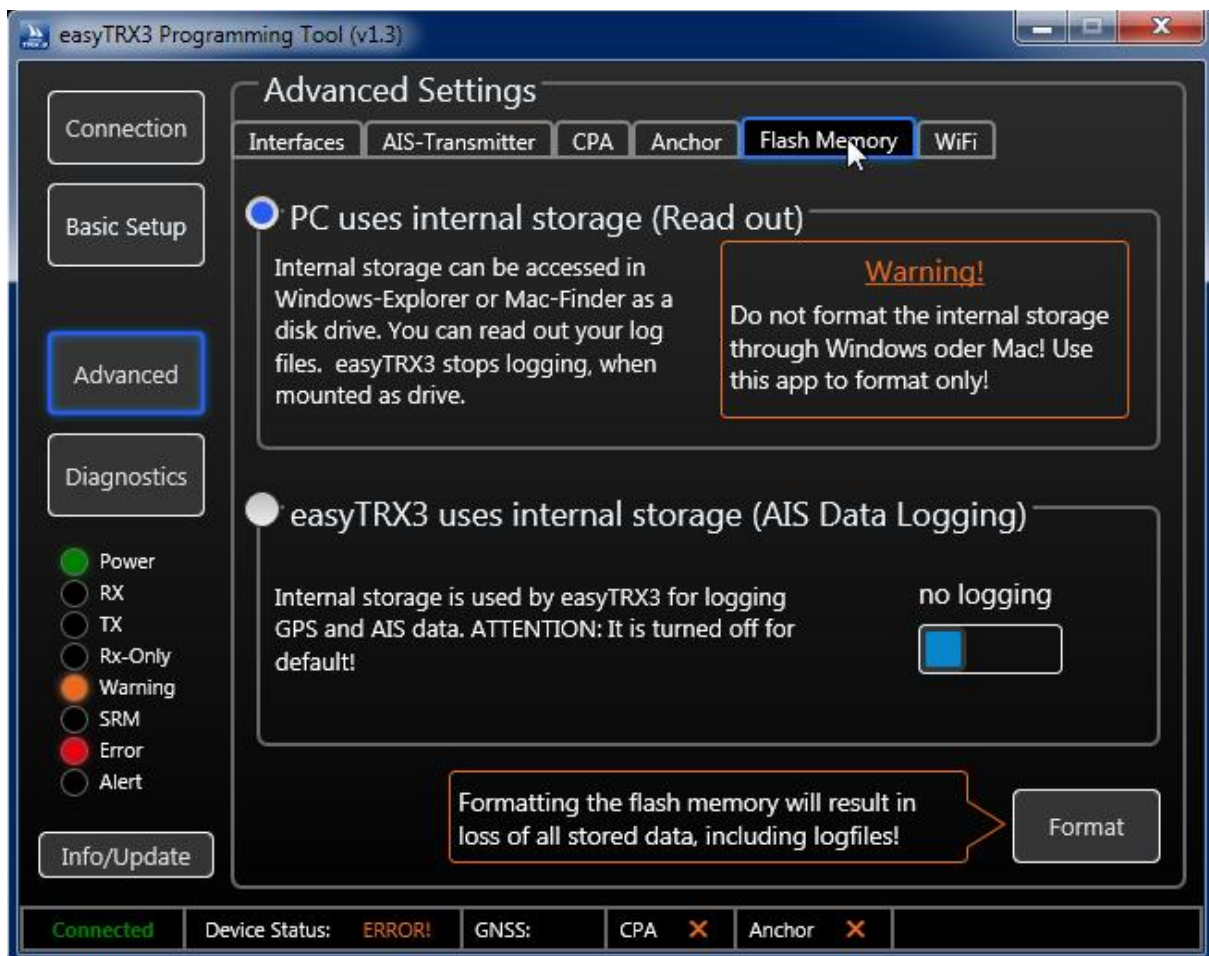

Figure: 28 Memory setting programming tool

In „read-out flash-memory“ mode you will have access to the internal storage of the easyTRX3. Here are located the PDF-file “user guide” and the programming software. Later on you will also find here the AIS and GPS data logging files.

Windows Explorer or iOS Finder will mount the easyTRX3 as an external Mass Storage Device (MSD).

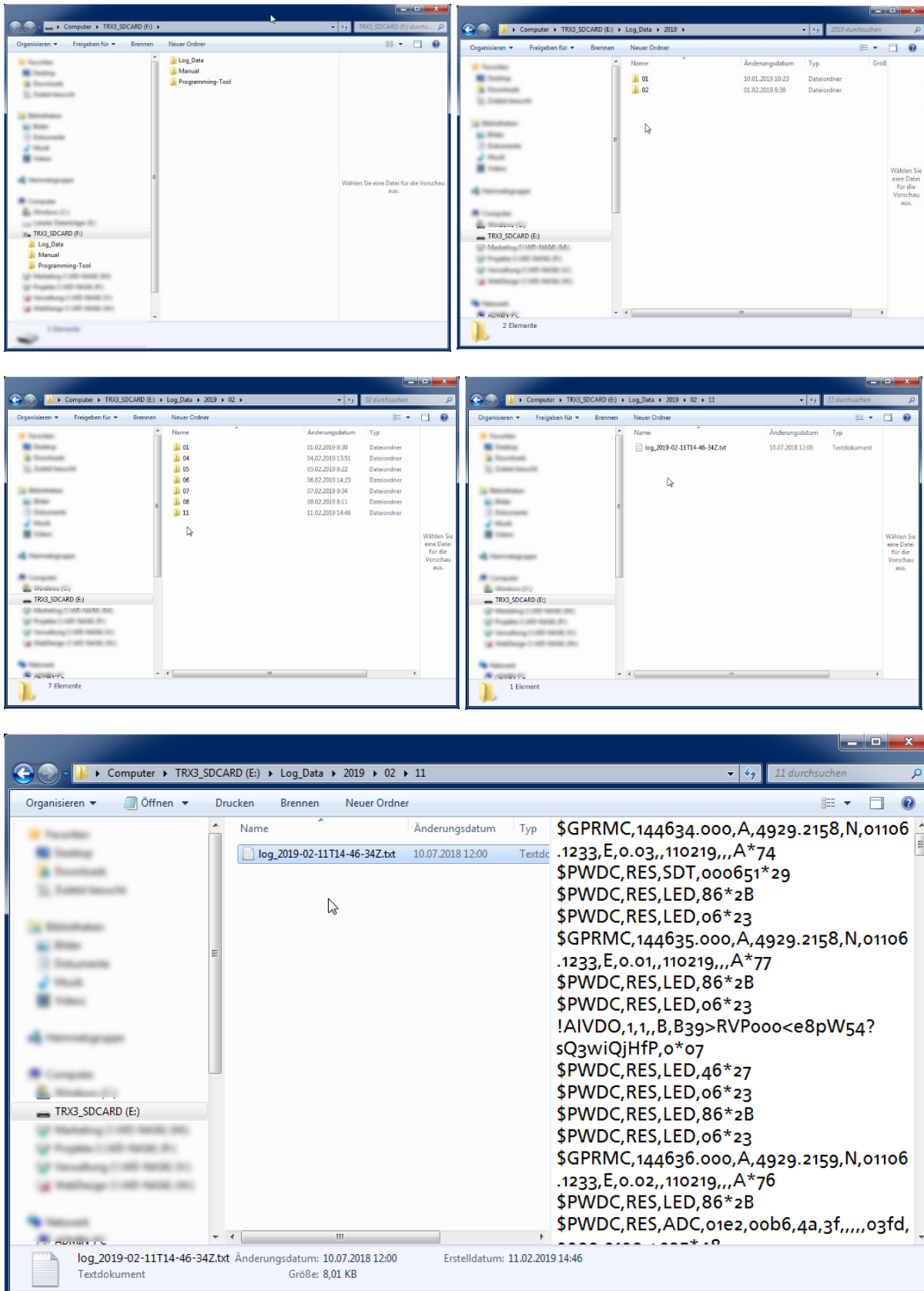

Figure: 29 directory information of internal storage of the easyTRX3 for "Log_Data"

If you want to store your trip data, you have to switch from „read-out“ mode into „AIS Data Logging“ mode by clicking on the free radio button. Additionally you have to activate the logging functionality by pressing „logging“ manually.

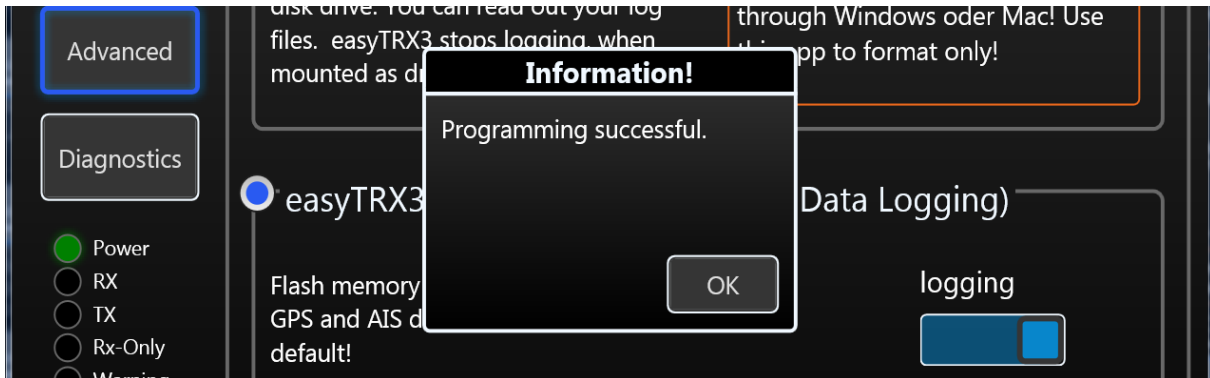

Figure: 30 Memory setting programming tool 2

In „Windows-Explorer“ or „iOS-Finder“ you can see that the easyTRX3 is no longer mounted as an external mass storage device.

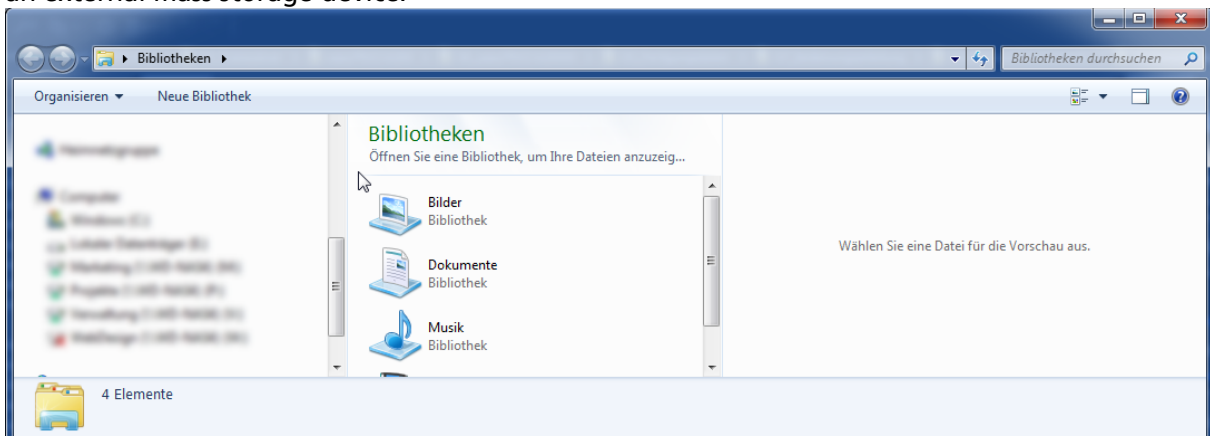

Figure: 31 easyTRX3 external Mass Storage Device no longer mounted

Important:

Please keep in mind to copy and save the software programming-tool as well as the PDF User Guide on your computer locally. Start installation of the software only from your computer because it might cause problems when installing from easyTRX3 internal storage. In case that you want to format the internal storage of the easyTRX3 for any reason, please use the programming tool exclusively. Formatting will cause to a total loss of data.

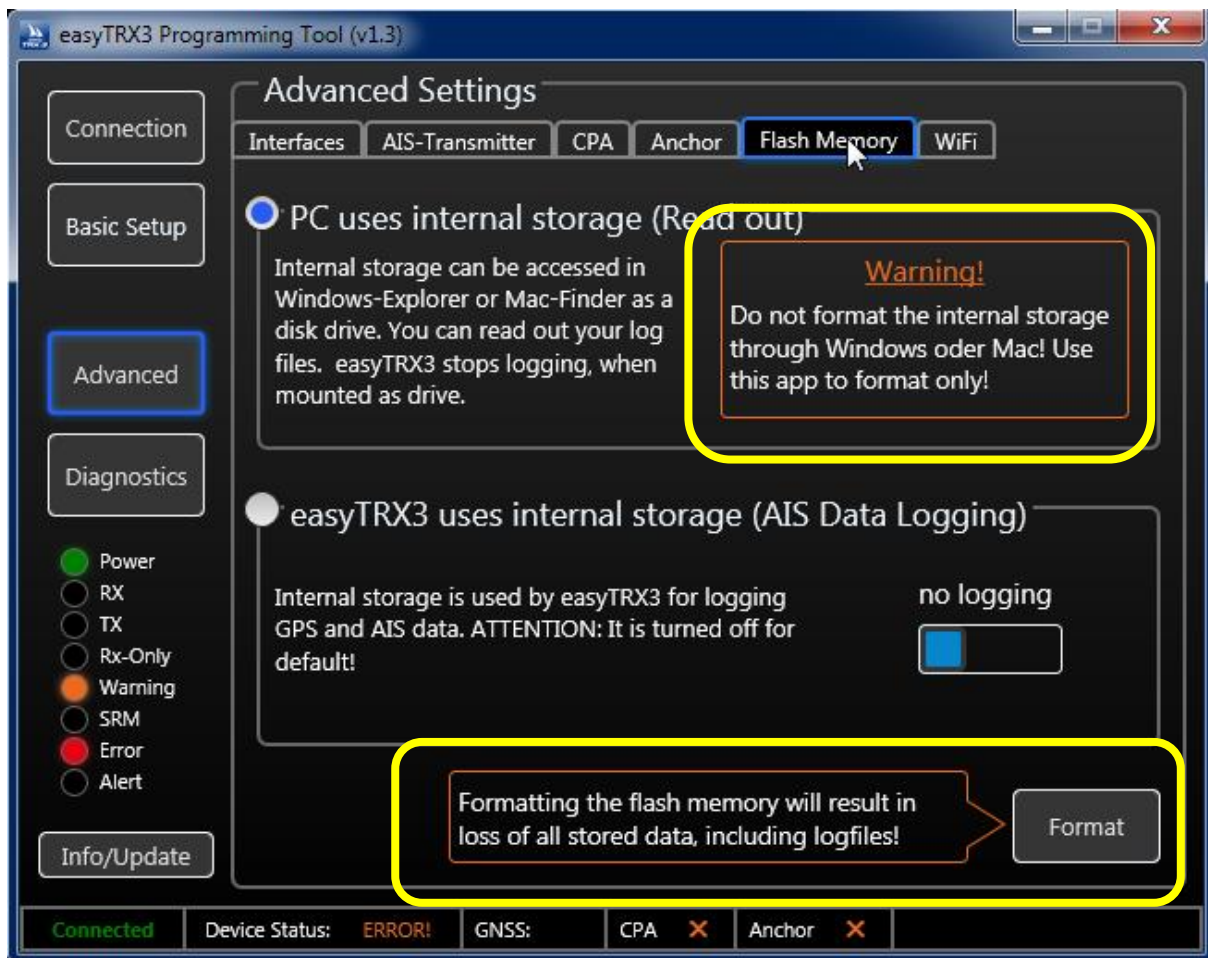

Figure: 32 Formatting of internal memory programming tool

8.1.11 WiFi Configuration

In case that you already have a mobile data network router aboard, you can integrate the easyTRX3 via WiFi connectivity into the router WLAN network.

This enables to forward the received AIS data to every connected mobile device which is connected to the router.

Please follow the next „step-by-step“ instruction of how to do the configuration.

Please go to „Advanced“ and click on „WiFi“.

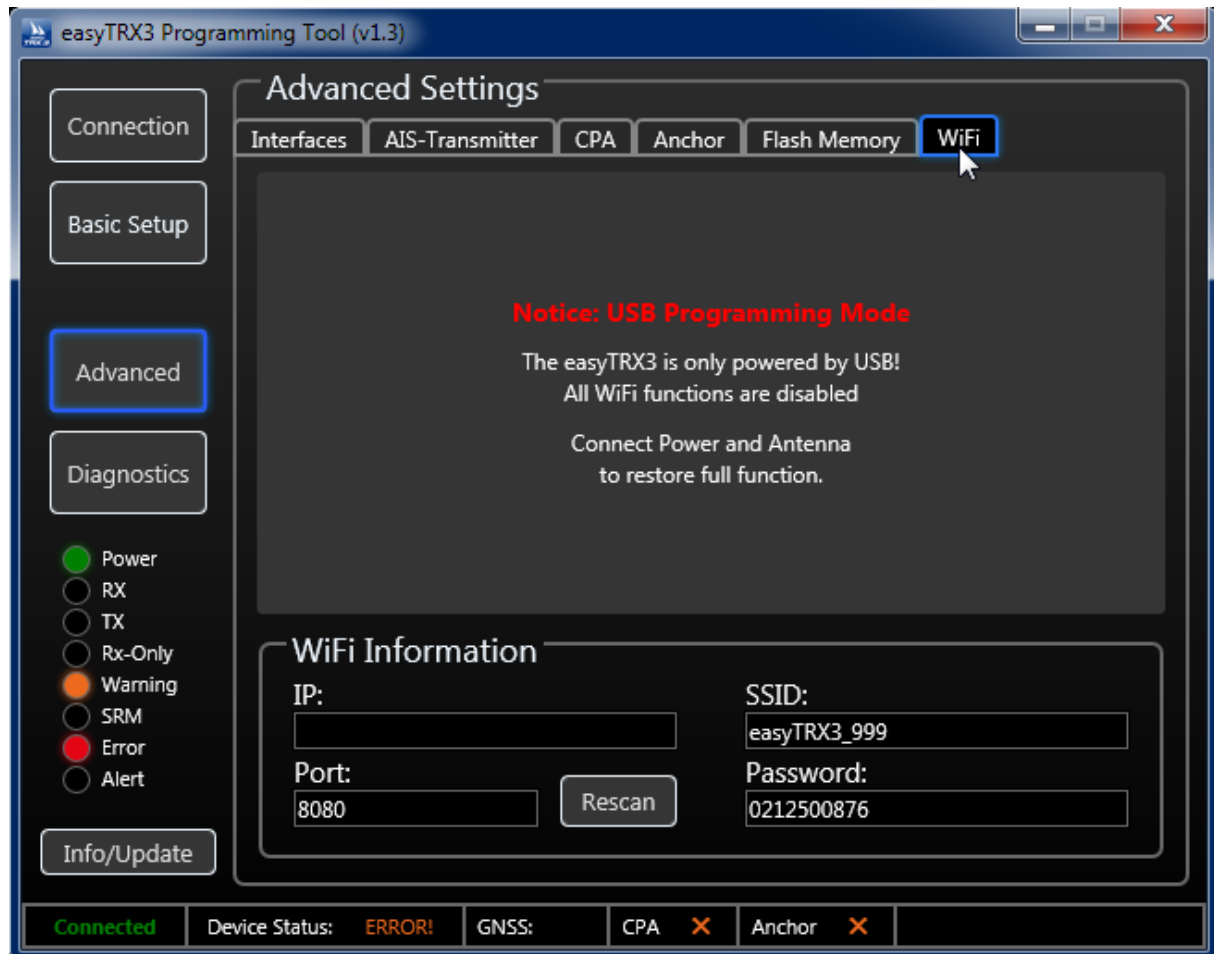

Figure: 33 easyTRX3 advanced WiFi settings

If your easyTRX3 is connected to the PC only by USB cable, you will see this picture. It shows that WiFi connectivity will only work with power supply via the power board net (12V-24V).

Connect the easyTRX2 to the board net, start the Programming-Tool again and go once again to „Advanced“ and “WiFi“.

As soon as the easyTRX3 is connected to the board net power source, you will see this follow-up picture:



Figure: 34 WiFi not connected

8.1.11.1 Router Setup

As you see in this „Attention advice“, you have to connect your PC/laptop to the WiFi network of the easyTRX3 first. You can find the login details at the bottom of this picture or on the packaging of the easyTRX3 (SSID “easyTRX3_199”, Password “xxxxxxx”).

Within the WLAN menu of the computer please choose the easyTRX3 network and click on “connect”.

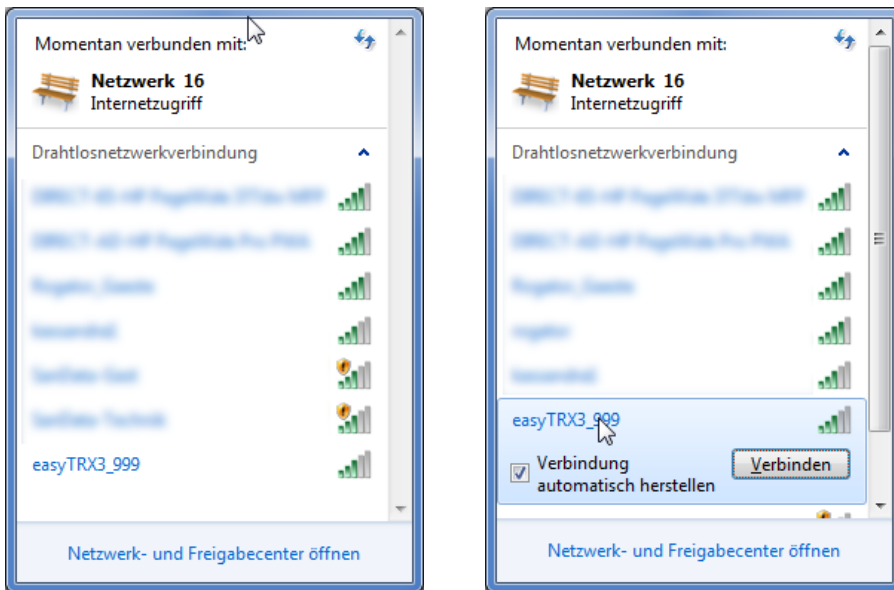

Figure: 35 WiFi Networks

Enter the password of the easyTRX3 and press "OK".

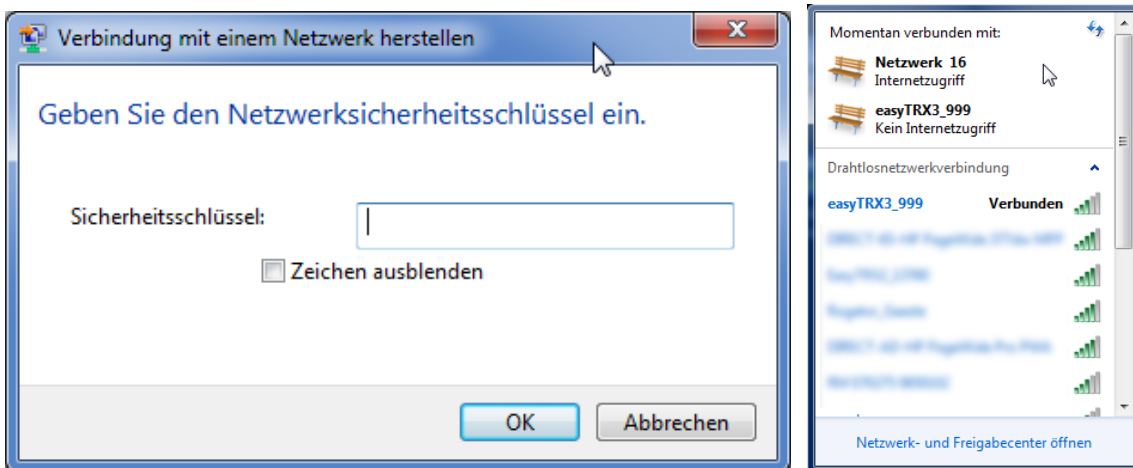

Figure: 36 WiFi Network password

After the PC/laptop is connected to the easyTRX3, please press "Rescan" to see the IP address of the easyTRX3 within the network.

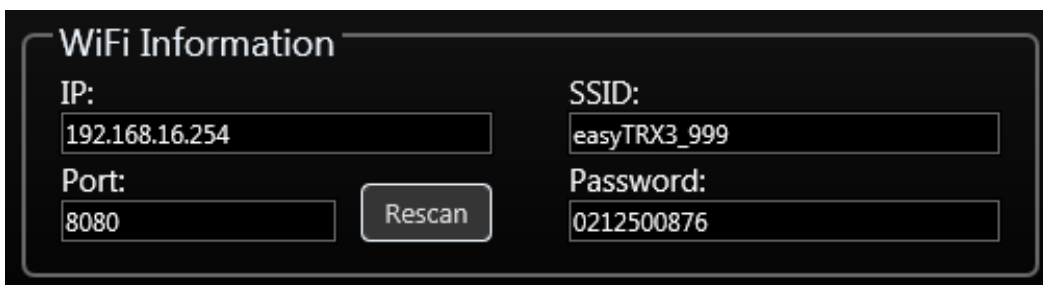

Figure: 37 WiFi Network information

Please click at „Router Setup“ on “Execute” afterwards.



Figure: 38 WiFi connected to PC, Tablet, etc. (1)

There are two windows parallel opening.

One is the configuration-window of the WiFi module, one is the “help-page” with detailed information what to do next.

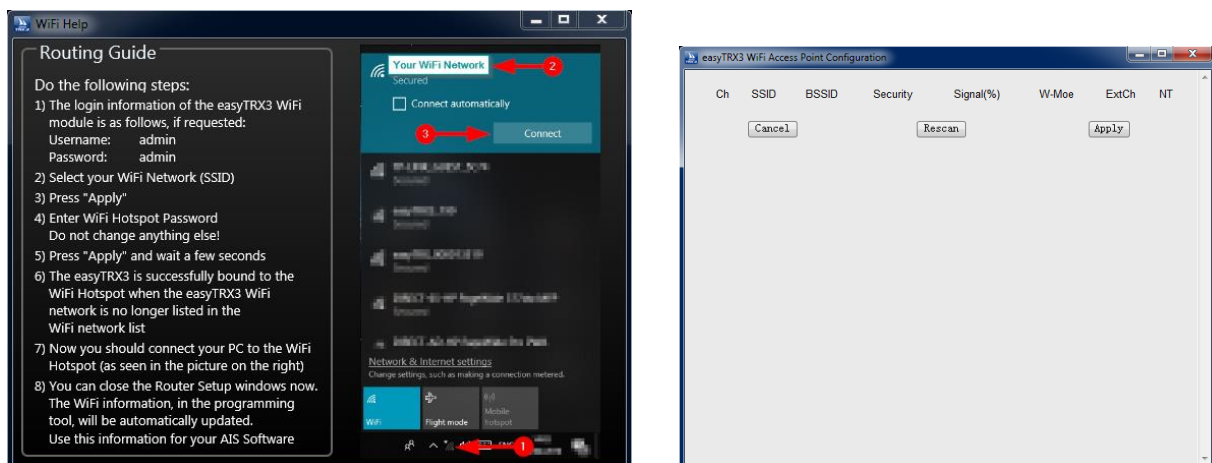

Figure: 39 WiFi configuration window and help page

Click on „Rescan“ to display the WLAN network of your router.

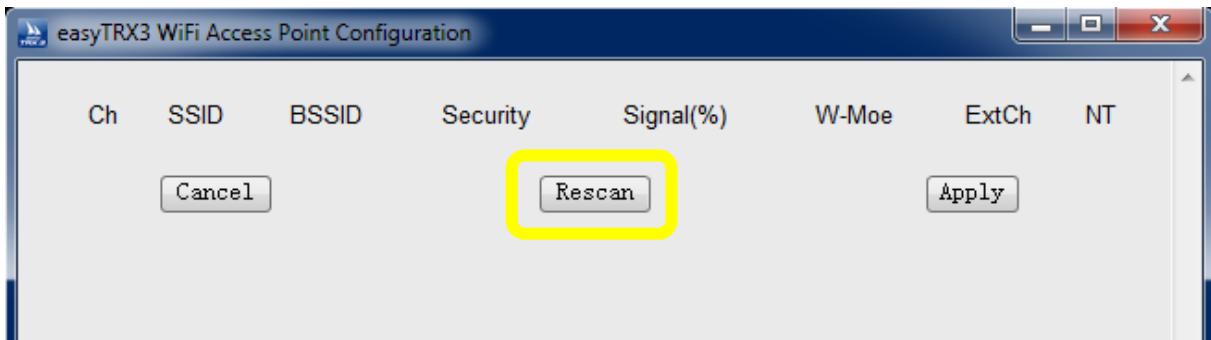

Figure: 40 WiFi Access Point Configuration Rescan

Choose your network by using the radio-button in front of the list and press "Apply".

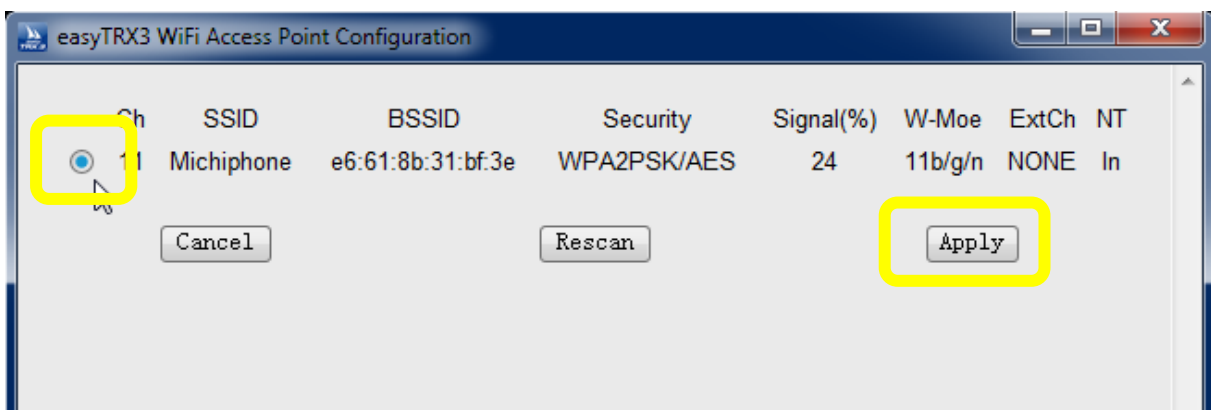
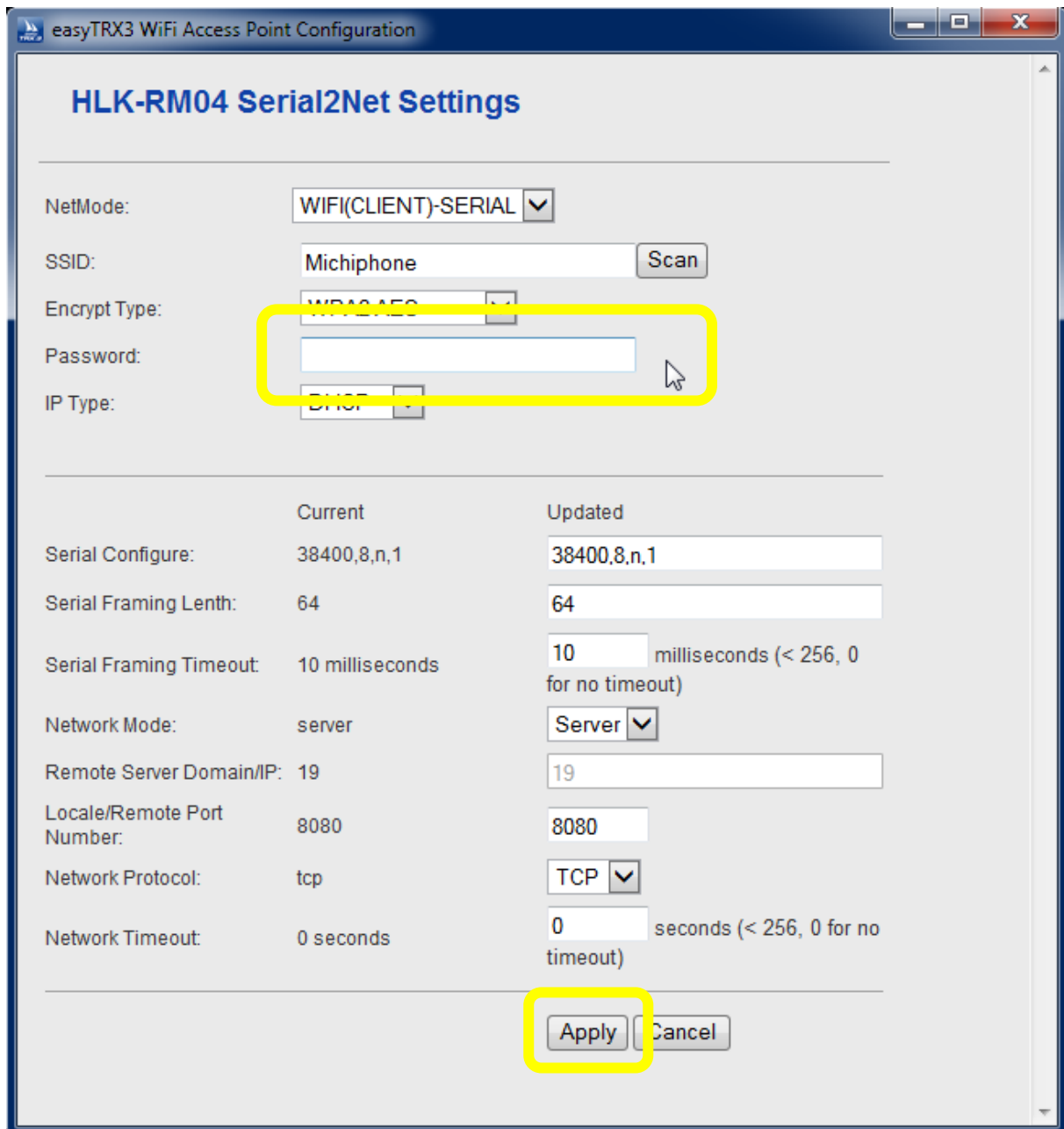

Figure: 41 WiFi Access Point Configuration Apply

After pressing „Apply“ you will see this input window:



HLK-RM04 Serial2Net Settings

NetMode:

SSID:

Encrypt Type:

Password:

IP Type:

	Current	Updated
Serial Configure:	38400,8,n,1	<input type="text" value="38400,8,n,1"/>
Serial Framing Lenth:	64	<input type="text" value="64"/>
Serial Framing Timeout:	10 milliseconds	<input type="text" value="10"/> milliseconds (< 256, 0 for no timeout)
Network Mode:	server	<input type="text" value="Server"/>
Remote Server Domain/IP:	19	<input type="text" value="19"/>
Locale/Remote Port Number:	8080	<input type="text" value="8080"/>
Network Protocol:	tcp	<input type="text" value="TCP"/>
Network Timeout:	0 seconds	<input type="text" value="0"/> seconds (< 256, 0 for no timeout)

Figure: 42 WiFi Access Point Configuration Settings

Here you have to enter the login password of your router and to press “Apply” afterwards. This will establish the integration of the easyTRX3 into the WLAN network of your router.

Close this window to get back to the easyTRX3 programming-tool window.

Press once again „Rescan“ at WiFi Information to check and to verify the new connection.

Ready.

Your easyTRX3 is now integrated into the network of your board router.

Important: If you want to integrate a new/different device into the network, or there might be problems with the connection process, please click the „Reset“ button at the “Reset Wifi” area.

Here you can cancel every setting done in the past and set the easyTRX3 into factory default setting again.

8.1.11.2 AIS on mobile devices within the WLAN network of the router

Within the “WiFi Information” you can see the IP address which the easyTRX3 was assigned to by the router.

If you want to use the received AIS data on your mobile device, which is already integrated into the router network please do the following steps:

- AIS capable software/app has to be installed
- Please go to the „connection settings“ of this software/app
- Enter the IP address and the port number the easyTRX3 has been assigned to (e.g. IP: 192.168.xxx / Port: 8080)
- This connection enables the mobile devices to grasp the AIS data from the easyTRX3 and to work with.

8.1.11.3 Explanations

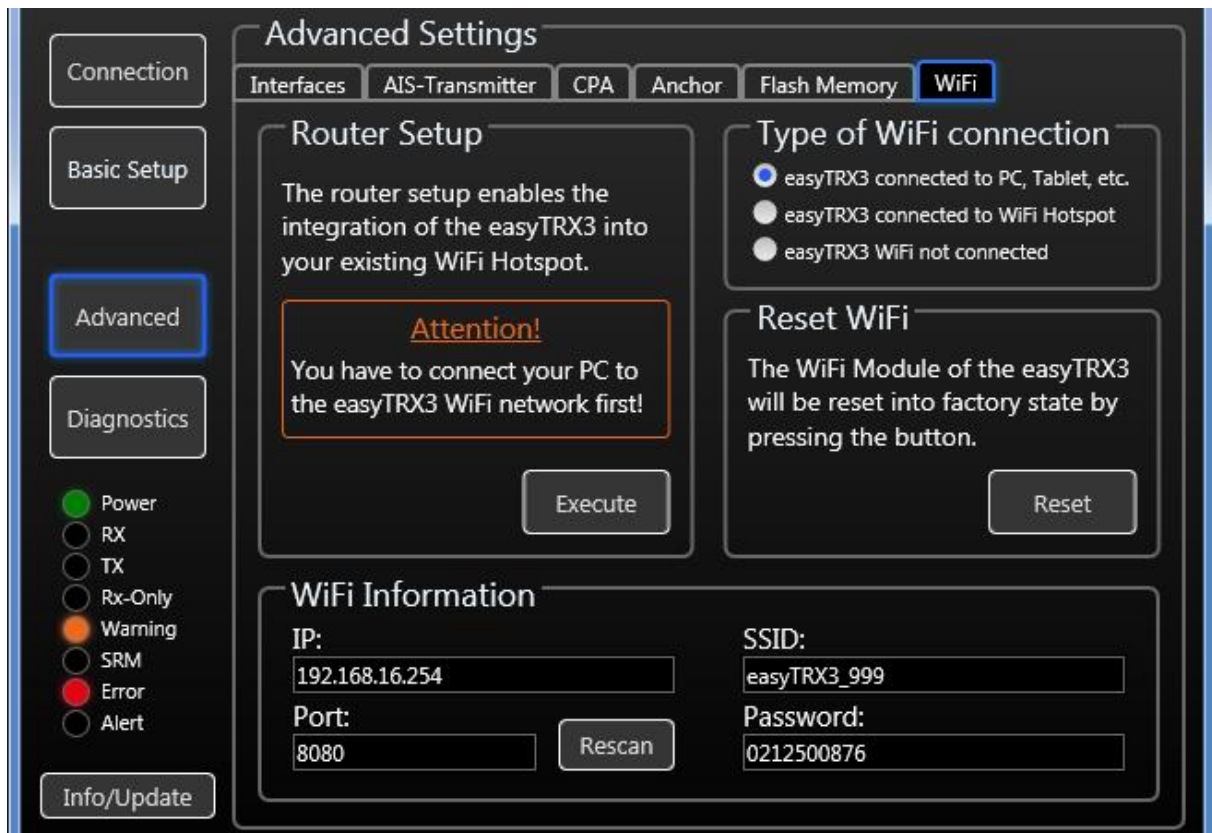

Figure: 43 WiFi connected to PC, Tablet, etc. (2)

Router Setup

To use for the integration of the easyTRX3 into the WLAN network of the board router.

Type of WiFi Connection

Here you can see the current status of the easyTRX3

- WiFi connection to a mobile device
- WiFi connection to a WLAN router / Hotspot
- No WiFi connection

Reset WiFi

Here you can set the WiFi module of the easyTRX3 back to factory settings.

WiFi Information

All information which belongs to the WiFi functionality of the easyTRX3 are listed here. By using the "Rescan" button, you can refresh the information.

- IP Address of the easyTRX3
- Port number in usage
- Name (SSID) of the easyTRX3 network
- Login password

8.1.12 Diagnostics

By means of the Diagnostics-Feature, you will get a perfect overview about how the easyTRX3 is running and about any "warning" or "error" messages, if something went wrong.

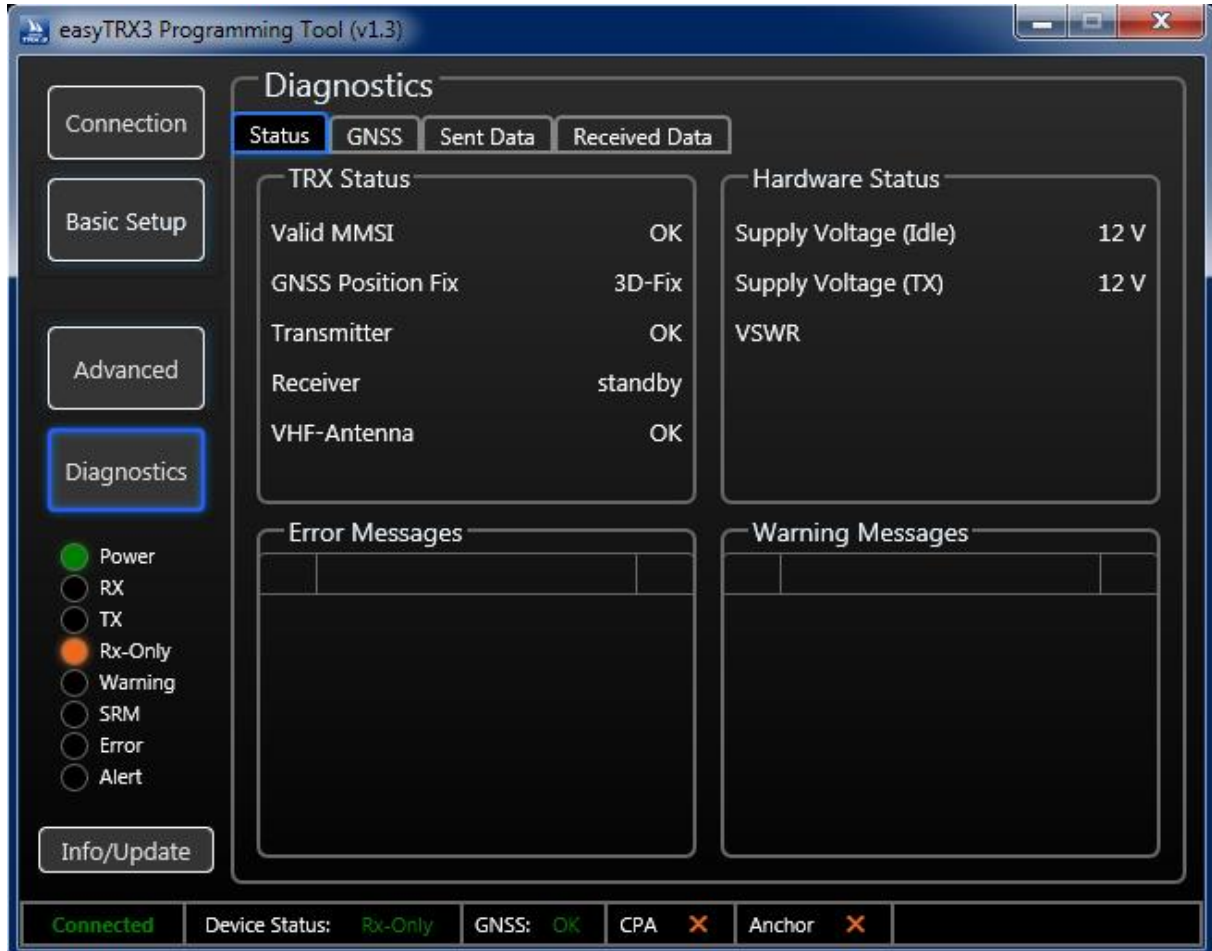

Figure: 44 Diagnostic screen programming tool

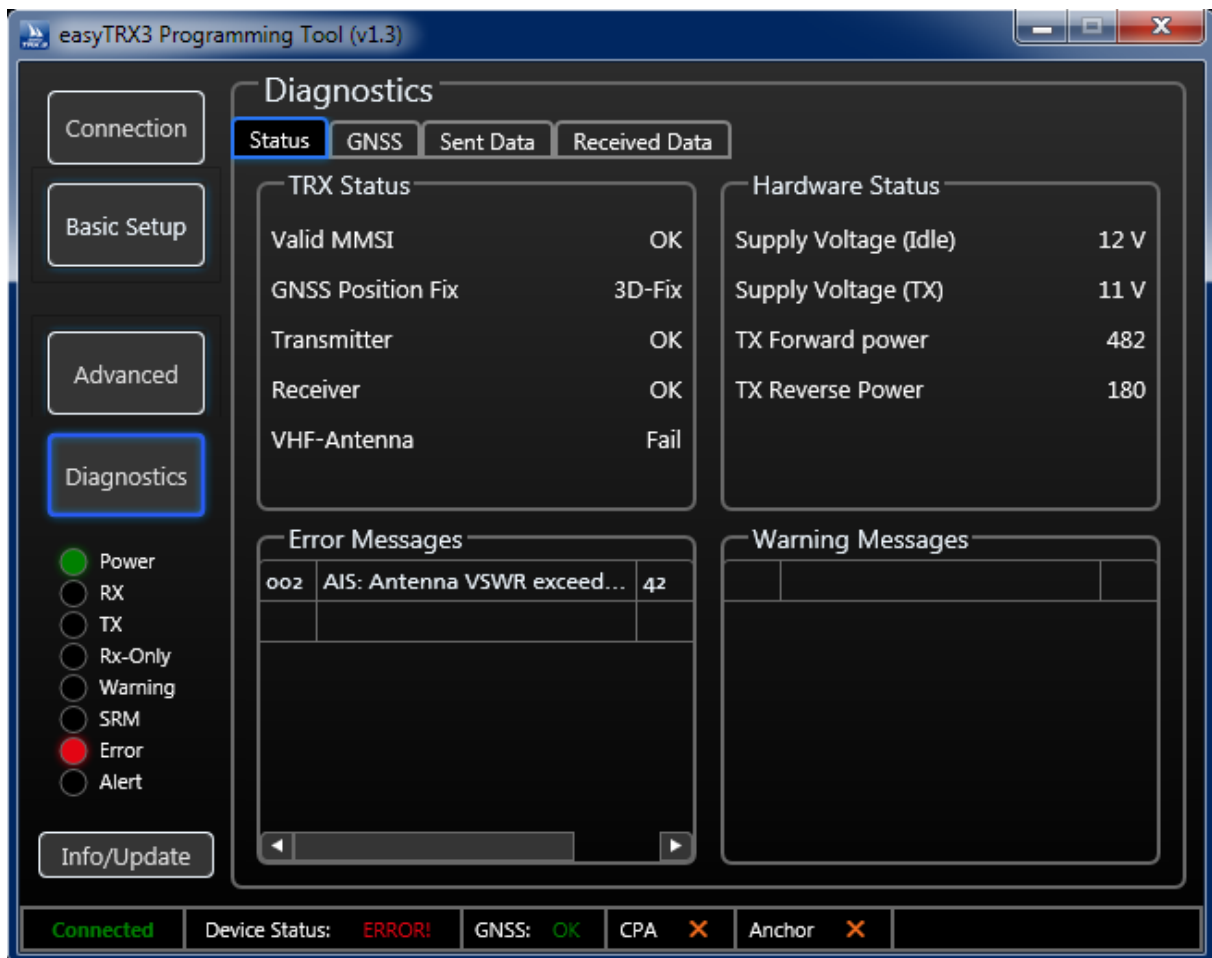

Figure: 45 Diagnostic screen programming tool

8.1.12.1 Status

TRX Status

In this screen area you get information about your MMSI number, your GPS fix, as well as a status of transmitting and receiving.

- Valid MMSI
As soon as a valid MMSI number is used, status will be "OK".
- GNSS position fix
If the status is "OK", the GPS is running proper.
- Transmitter
As soon as the transponder has send out data for the first time, the value changes from "standby" to "OK". If there will be a malfunction within the unit, the status will be "Error" and the easyTRX3 is no longer working proper anymore. Please contact your service partner. By means of the Error messages more details are given to you.
- Receiver
As soon as the first AIS telegram was received by the easyTRX3, the value changes from "standby" to "OK". If there will be a malfunction within the unit, the status will be "Error" and the easyTRX3 is no longer working proper anymore. Please contact your service partner. By means of the Error messages more details are given to you.

- VHF Antenna
As soon as the VHF antenna is connected, the status is "OK". If there is anything wrong with the connection of the antenna, the value changes to "Fail". By means of the Error messages more details are given to you.

Hardware Status

In this area you get information about the supply voltage of the easyTRX3 as well as the ration between "forward power" and "reverse power" of the VHF antenna.

- Supply Voltage (TX) / Supply Voltage (idle):
This is the voltage value during transmission. For transmitting AIS data, the easyTRX3 takes approx. 2A power for 0.2 seconds. If the used cable diameter are too thin or even too long, the voltage can drop down under the shown "Idle" value which might cause to limited transmission power. To solve the problem, please check the cable connections or use thicker ones.
We strongly recoment to use 2 mm diameter cables for the power supply of the easyTRX3
- VSWR
 - OK: the antenna configuration and all the connections are working proper.
 - Fail: the antenna is not transmitting well because of a bad cable or bad connection. Please check all your connections or ask your service-partner.

Error Messages

Within the "Error Messages" area there are hints to the possible malfunction of the system around the easyTRX3. These short messages will give more detailed information about the possible malfunction of the easyTRX3 and will guide you or your service partner to solve the problem.

See a short overview of possible Error Messages at chapter 13.

Warning Messages

The warning messages will appear only for a short time until the corresponding configuration has changed.

For example: "no valid fix" means that the easyTRX3 has got no GPS position fix up to now. As soon as there is a position fix, this warning message disappears.

Every 30 seconds the easyTRX3 is doing a self-test. Each Error or Warning Message has got a 60 second count-down. If the cause of the message is no longer given within the next self-test, the message disappears. Most of the Error Messages are caused by hardware malfunction and/or cable connection failure. These messages will still appear, even within the next following self-tests.

All status LEDs on top of the easyTRX3 are also shown on the lower left part of the programming screen. This is very useful if the easyTRX3 is mounted out of sight.

8.1.13 GNSS

In this area you will get detailed information about the GPS data, the easyTRX3 has to work with.

GNSS Status

Here is shown an overview about course and speed over ground, the current position, satellites available and in use as well as UTC world time.

- **Course over Ground:**
Displays the current course over ground of the vessel.
- **Speed over Ground:**
Displays the current speed over Ground of the vessel.
- **Latitude / Longitude:**
Displays the current exact position of the vessel.
- **Satellites in view / Satellites in use:**
Displays how many satellites are available for GPS positioning and how many are used for GPS positioning in reality.
 - **HDOP:**
The horizontal dilution of precision display is a term used in satellite navigation and geomatics engineering to specify the additional multiplicative effect of navigation satellite geometry on positional measurement precision. The HDOP benchmark is 2.5. As lower the value, as better it is.
Within the picture below you can see a HDOP value of 0.8 which is very good.

GPS Satellites

This is a display screen of satellites available (grey) and in use (blue).

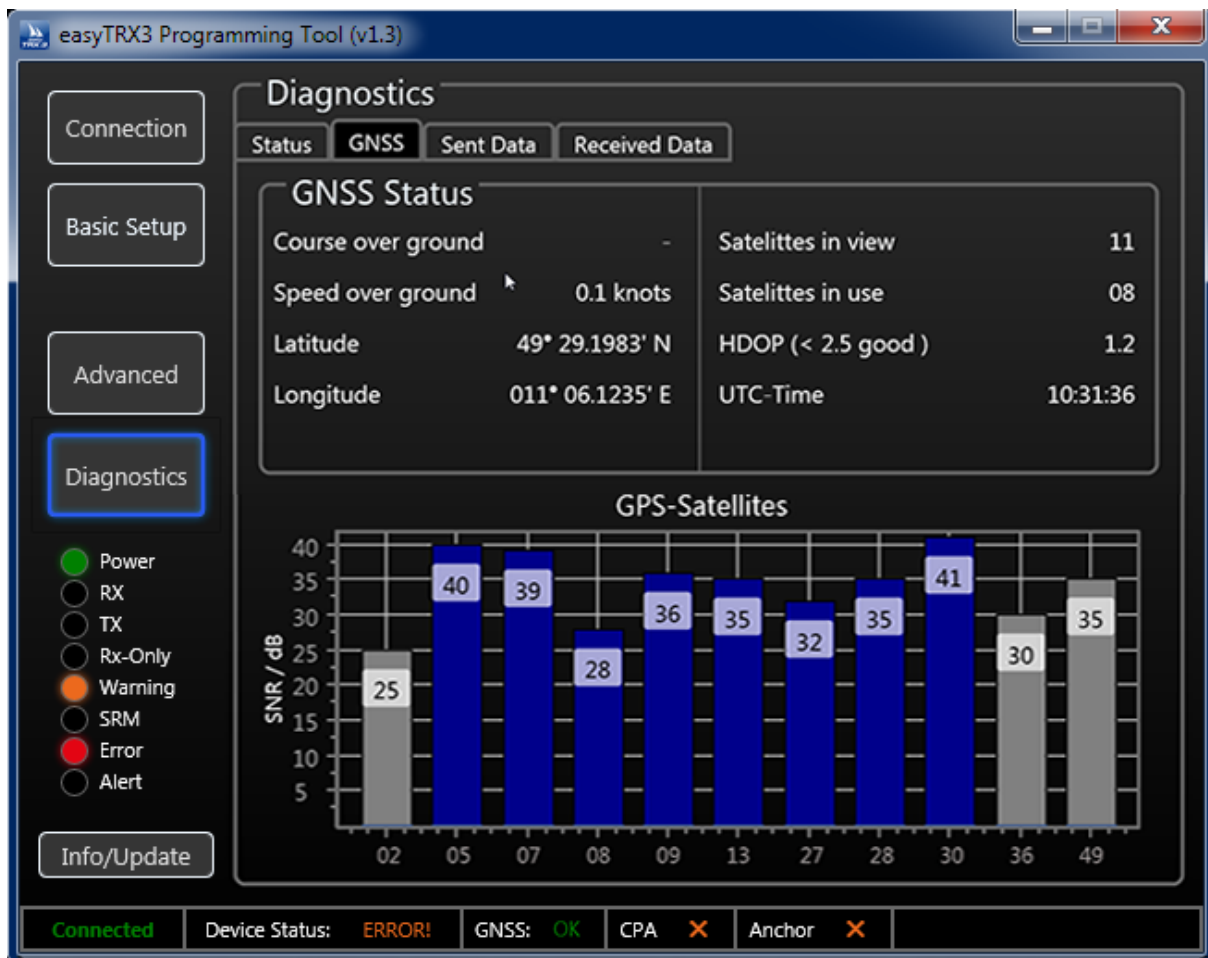

Figure: 46 GPS Status screen programming tool

The value in the bar charts displays the GPS signal-strength. As bigger the value, as better the received GPS signal is.

8.1.13.1 Data

Sent Data

Within the send data overview, you will see all the Dynamic Data and Static Data which are send into the AIS network to the other participants.

You also get an information about when the last transmission has been sent.

In case that you have activated the long-range satellite AIS, these transmission information are displayed in addition.

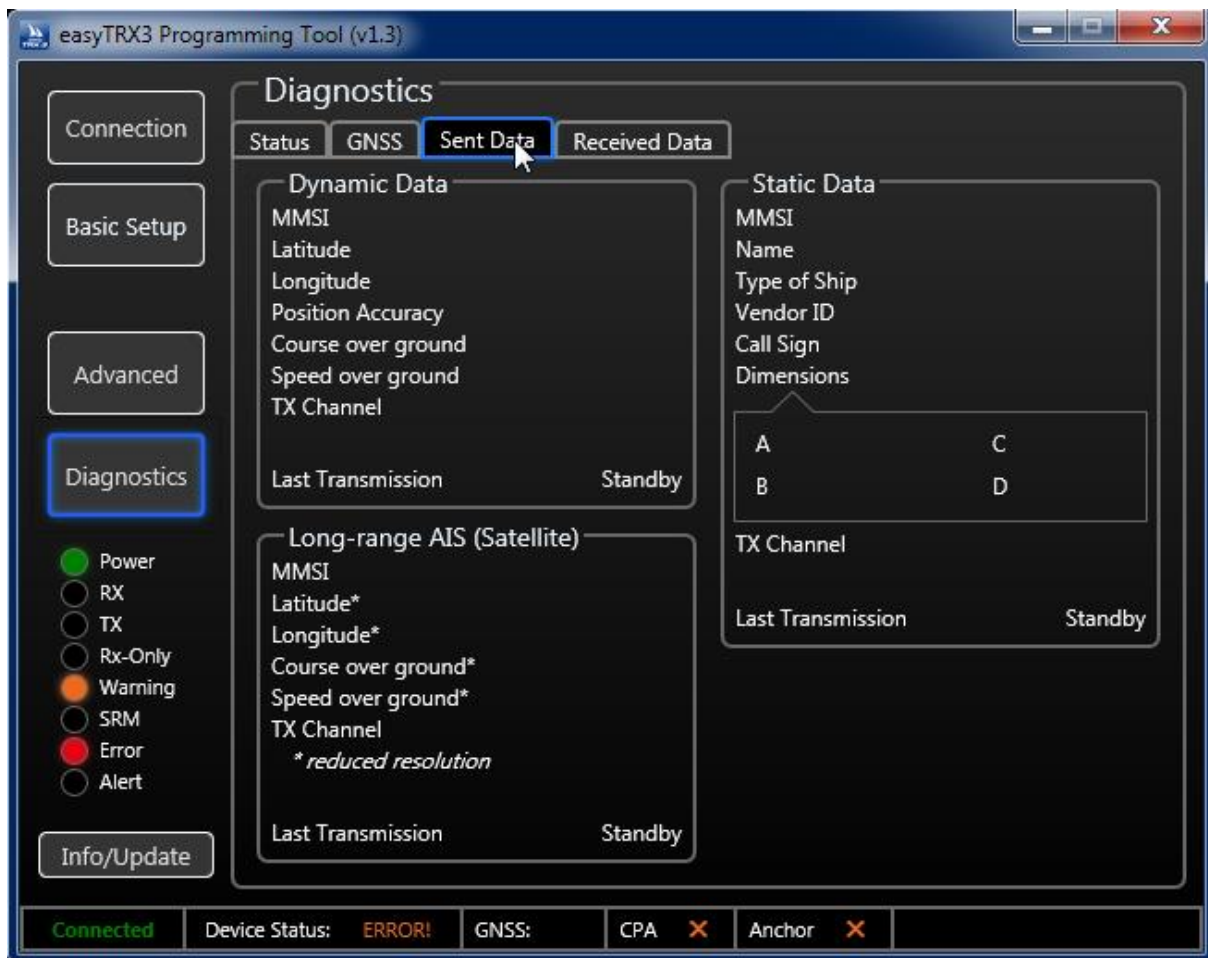

Figure: 47 Sent data screen programming tool

Received Data

All AIS data received from vessels in your vicinity, are displayed here in a table. You can select a single vessel by clicking on the ship list entry.

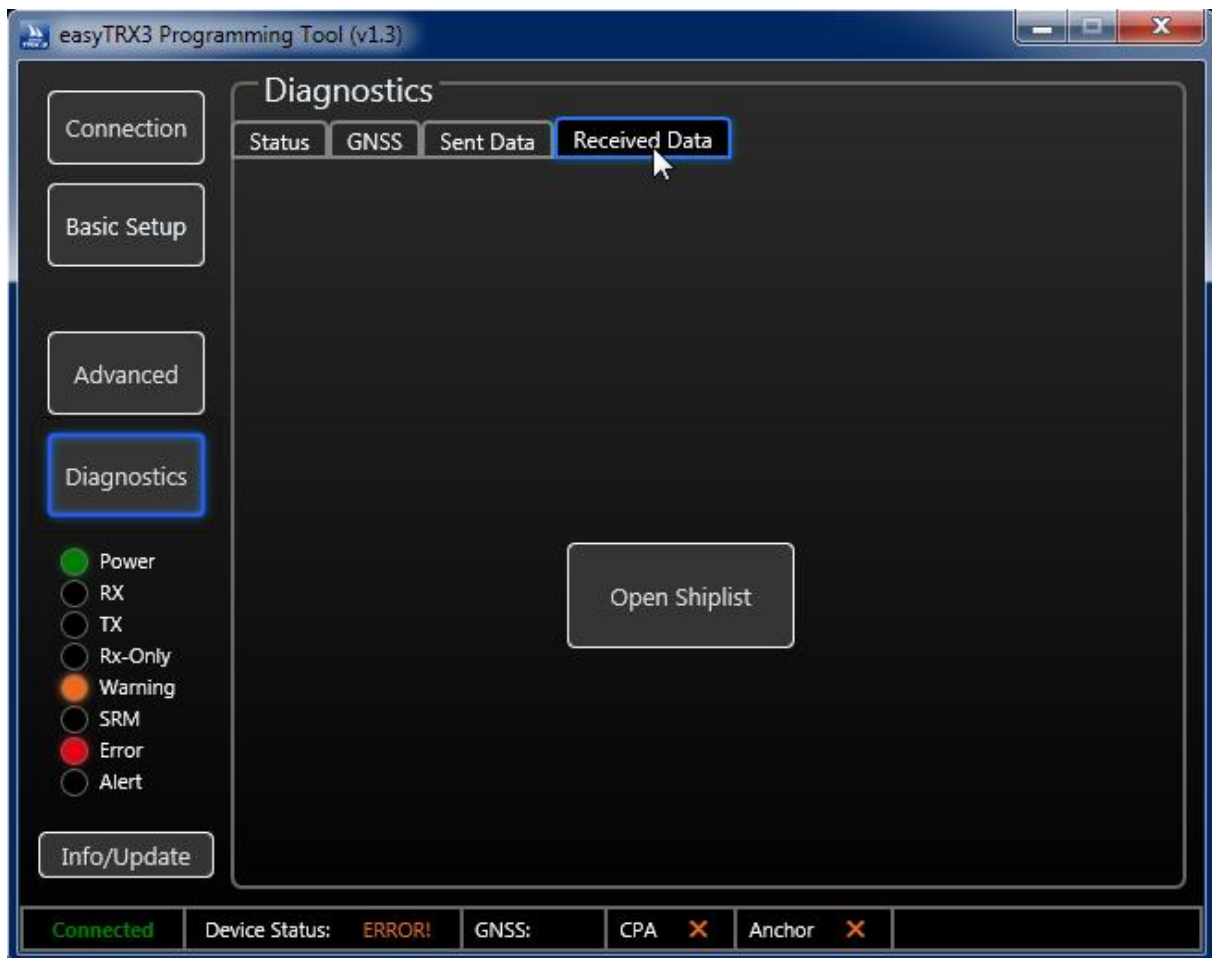

Figure: 48 Received data screen programming tool

Info / Update:

By pressing the „Info/Update“ button, you open a page, where you can see some information about device version, serial number, hardware version, firmware version and the BSH Number. You can also update the firmware or reset the easyTRX3 back to manufacturer settings, if there might be a need for.

A factory reset will delete all data and settings.

In case you are initiating the reset, the software will create a key, which you send by email to support@weatherdock.de

Weatherdock will answer your email with a pin-code you have to enter in the programming software. Please be aware that the pin-code is valid for single-use only.

Enter the pin-code and start the reset process.

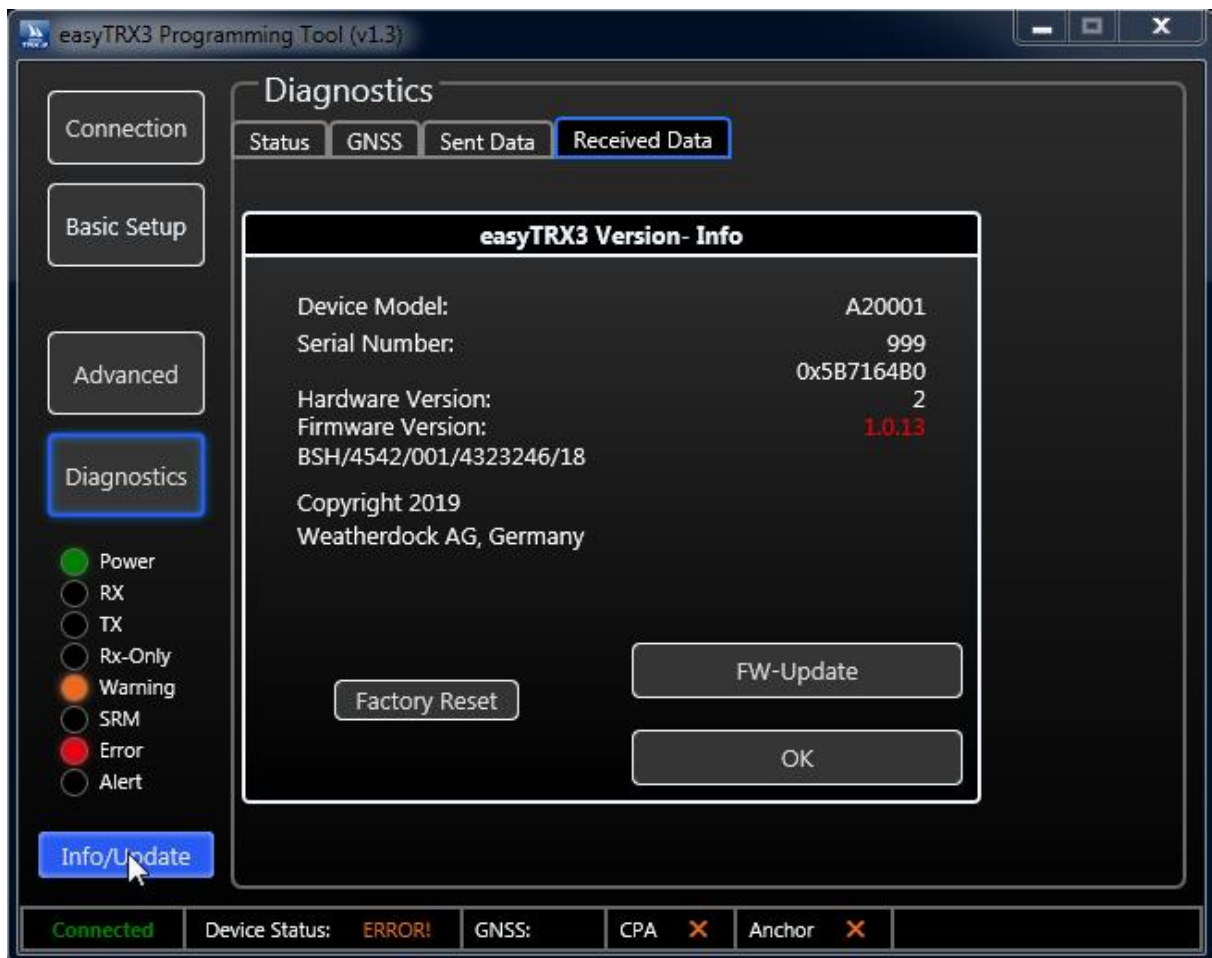

Figure: 49 Factory reset screen programming tool



Figure: 50 Pin-code page programming tool

Firmware Update:

Weatherdock will inform you via homepage-news about new available **firmware** updates **for the easyTRX3**. Please follow the given link to download the files and save them on your computer locally.

Press "FW-Update" and see the following screen appearing.

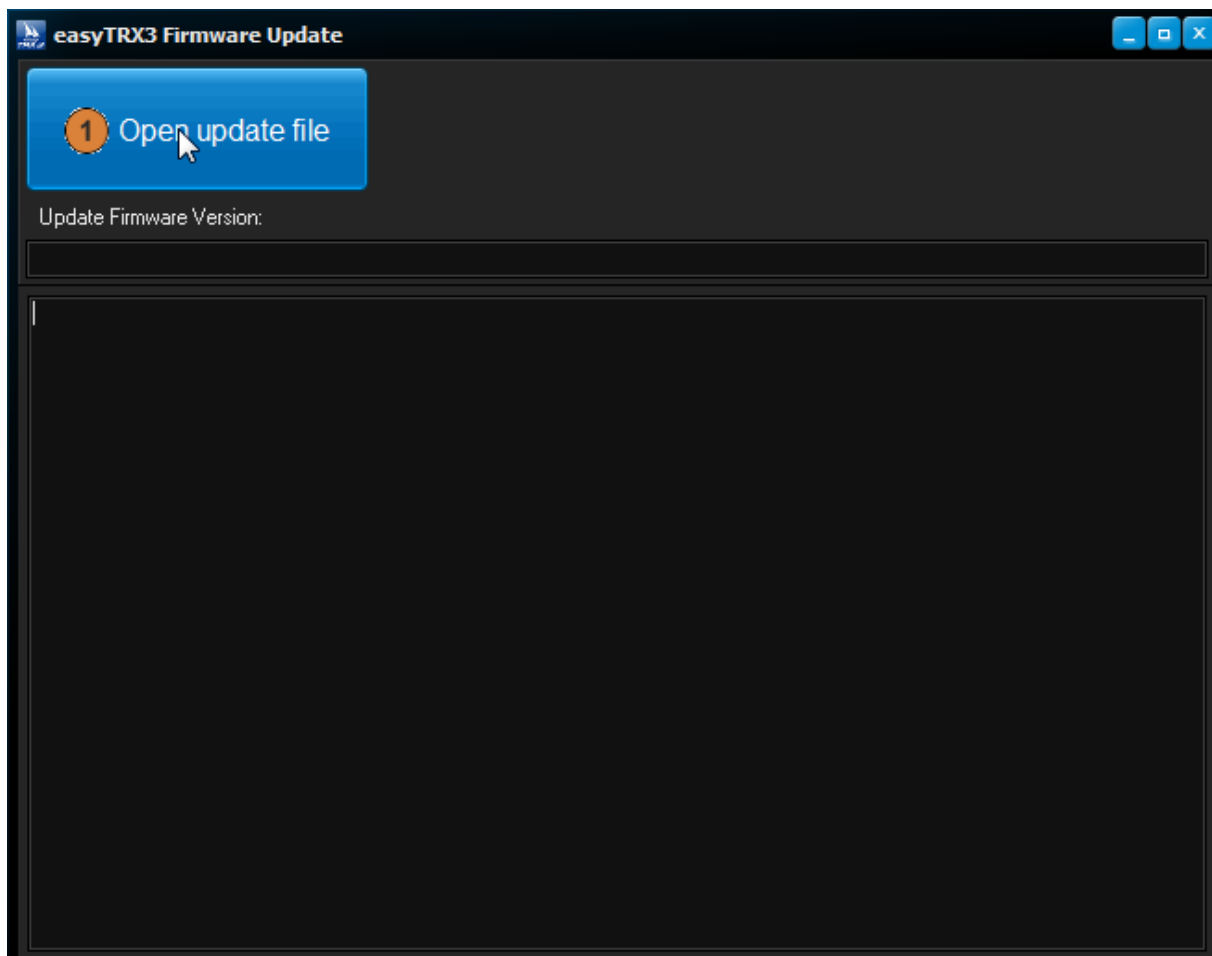

Figure: 51 Firmware update screen programming tool

Please select the directory where you saved the downloaded firmware files and follow the instructions of the software to install the new firmware.

8.2 WiFi Connection to a Laptop

In case you bought an AIS Class B transceiver easyTRX3 with integrated WiFi module or you have afterward added it to the easyTRX3, you will be able to realize the programming and configuration procedure via WiFi with your laptop.

Due to the fact, that there is no access to the internal storage via WiFi connection, you have to download the programming software from our homepage with the following link

www.easyais.com/info/download-wd/software

- Please install the downloaded software on your laptop and open it.
- You will see the starting screen of the easyTRX3 programming tool. Press on "Connection" and select WiFi afterwards
- Activate the WiFi connectivity of your laptop, select the easyTRX3 network and log in with SSID and password. You will find the log-in data labeled on the back of the easyTRX3 as well as on the package.
- Enter Host-IP address and Port number into the software and press "connect" to establish the connection.

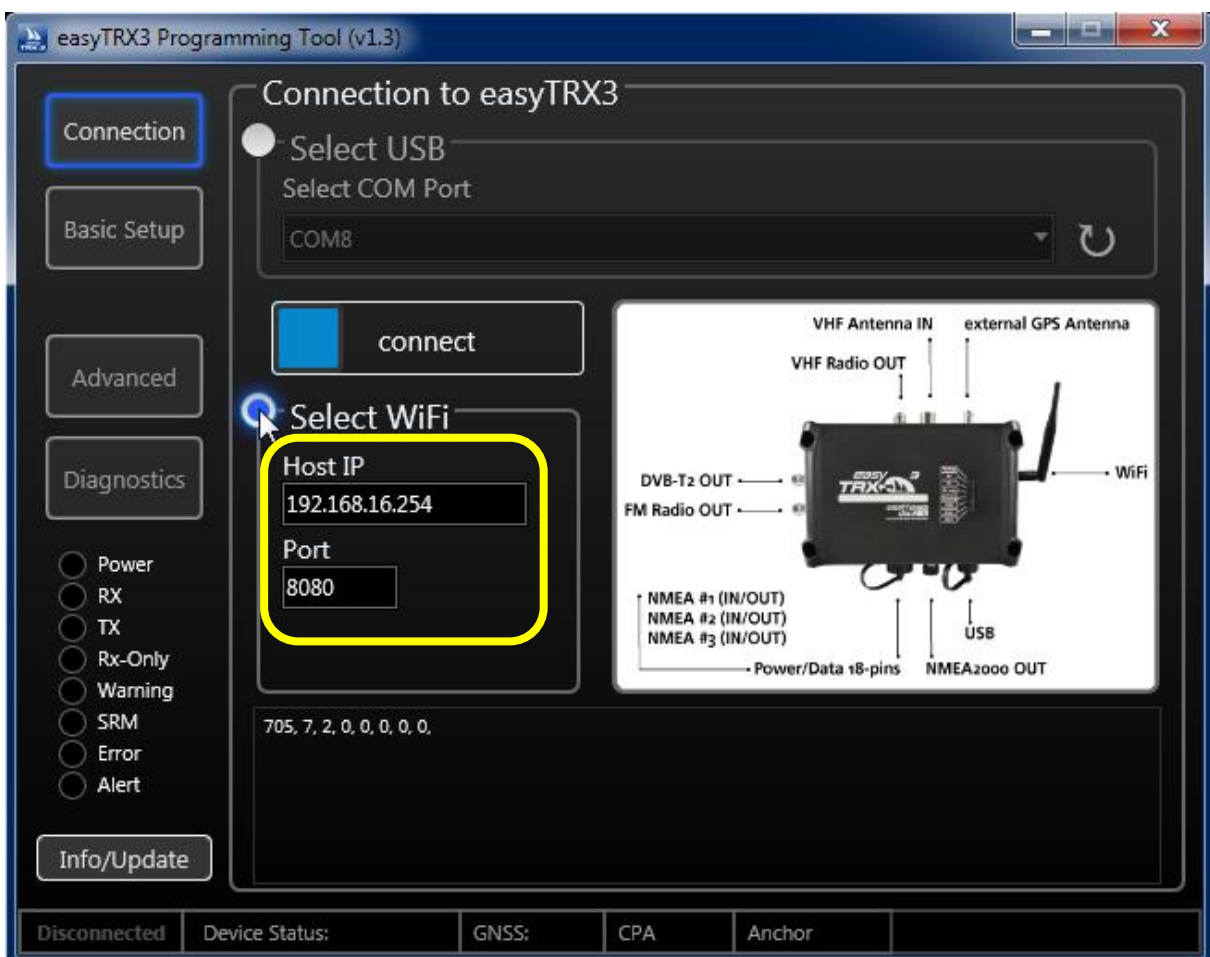

Figure: 52 WiFi connection screen programming tool

- As a confirmation you can see data rows coming up in the lower window.

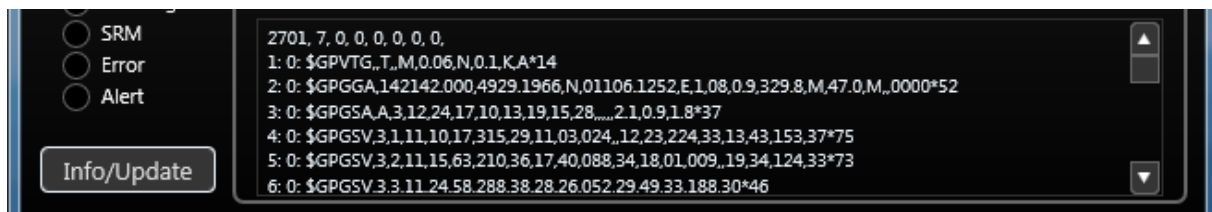

Figure: 53 WiFi connection screen programming tool 2

After a few seconds when connection is established, the software automatically switches to „Basic Setup“.

From this point on you can follow the detailed user guide instructions from chapter 8.1 and following.

8.3 WiFi Connection and App via mobile terminal device

In case you bought an AIS Class B transceiver easyTRX3 with integrated WiFi module, you will be able to realize the programming and configuration procedure via WiFi connection to your smartphone or other mobile terminal device.

The free of charge app “easyTRX3-Manager” is available at Apple App-Store® as well as Google Play-Store®. Please download and install the app.



easyTRX3-Manager
(Language: English)

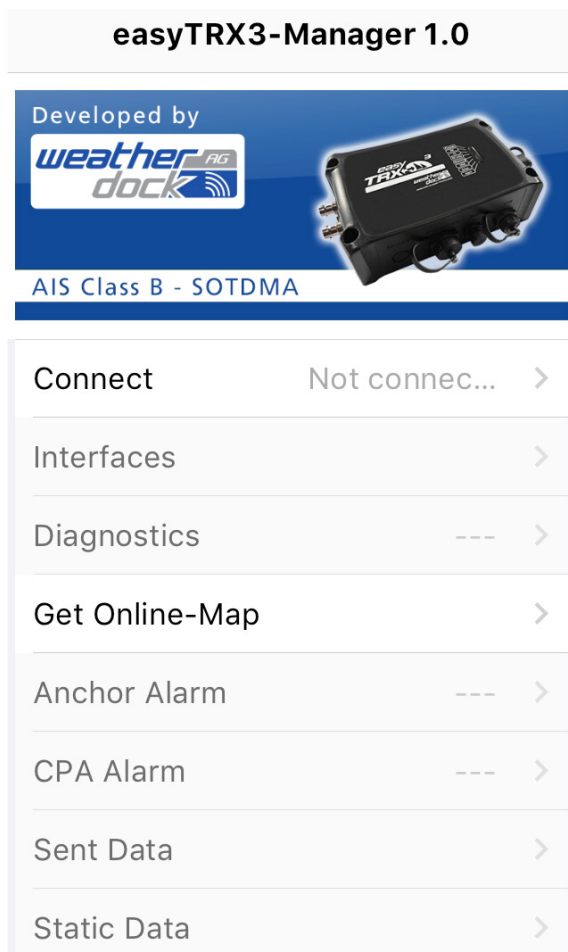

For using the app „easyTRX3-Manager“ you first have to activate the WLAN functionality of your mobile terminal device.

You will find the network-name of the easyTRX3 and the password labeled on the back of the unit.

After you have opened the app, you see this starting screen. Within this user guide the iOS® app for iPhone® is used. The illustration with Android® devices might be different, but the procedure and functionality will be similar.

The starting screen is the basic element of the app where to step into the several different topics. Once you entered your data or you did some changings within the settings, you always get back to the starting screen.

Press “not connected” to enter the connection details to connect to the easyTRX3.

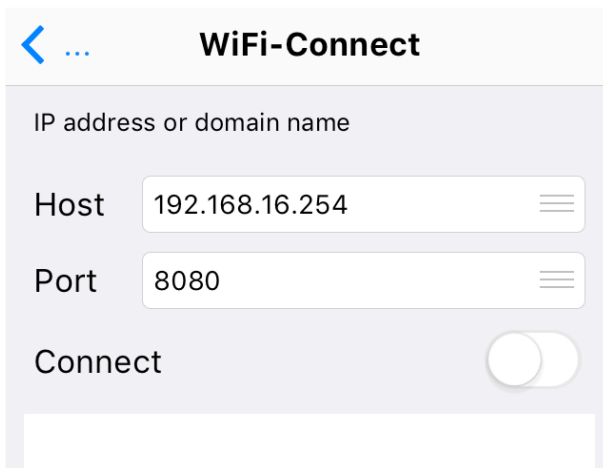

At the back of the easyTRX3 and sideways on the package you will find detailed information About

SSID
Password

With these information you specify the connection to the easyTRX3.

Please use for

- **Host: 192.168.16.254**
- **Port: 8080**

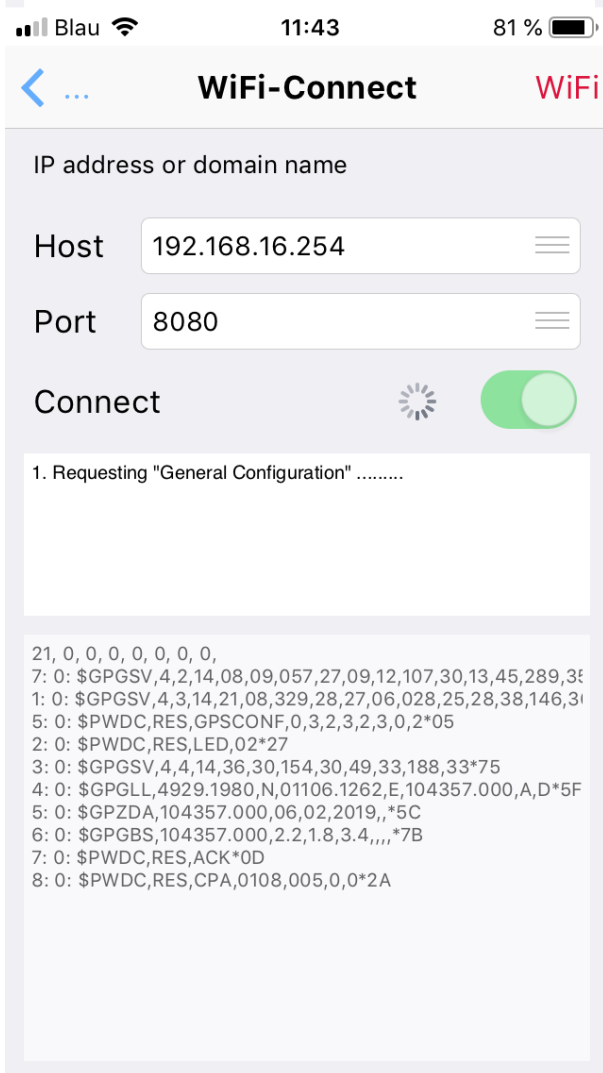

After you have entered the connection details, please press on the “connect” slider.

As a confirmation that the connection has been established successfully, you can see data rows coming up in the lower part of the app.

By pressing the arrow symbol in the upper left part, you will get back to the center screen.

```

21, 0, 0, 0, 0, 0, 0, 0,
7: 0: $GPGSV,4,2,14,08,09,057,27,09,12,107,30,13,45,289,30
1: 0: $GPGSV,4,3,14,21,08,329,28,27,06,028,25,28,38,146,30
5: 0: $PWDC,RES,GPSCONF,0,3,2,3,2,3,0,2*05
2: 0: $PWDC,RES,LED,02*27
3: 0: $GPGSV,4,4,14,36,30,154,30,49,33,188,33*75
4: 0: $GPGLL,4929.1980,N,01106.1262,E,104357.000,A,D*5F
5: 0: $GPZDA,104357.000,06,02,2019,,*5C
6: 0: $GPGBS,104357.000,2.2,1.8,3.4,,,,*7B
7: 0: $PWDC,RES,ACK*0D
8: 0: $PWDC,RES,CPA,0108,005,0,0*2A
  
```

easyTRX3-Manager 1.0

Developed by



AIS Class B - SOTDMA

Connect	Connected	>
Interfaces		>
Diagnostics	All OK	>
Received Data		>
Anchor Alarm	Not active	>
CPA Alarm	Not active	>
Sent Data		>
Static Data		>

The easyTRX3 has immediately started with a self-test and show the current status quo as displayed.

In the example everything is "OK" and "Anchor Alert" as well as "CPA Alert" are not activated.

Please select the last topic of the list "Static Data" to program your own vessel data into the easyTRX3 unit.

For static data you will need your MMSI number, you might already have from your VHF radio.

If you don't have any MMSI number yet, you can apply for it at the German Federal Network Agency. In chapter 1.4 you can follow a download link for the apply form.

Static Data

MMSI

Name

Call Sign

Ship Type

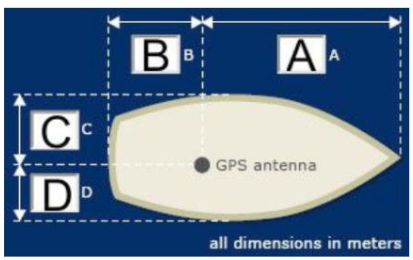

A

B

C

D

Here you can enter your own vessel data such as

**MMSI
Name
Call Sign**

Additional you can select from a drop-down-list which type of vessel.

If you are not having a valid MMSI number, the easyTRX3 is not able to send out data into the AIS system. The unit is automatically set into pure reception mode (RX only).

Without a valid entered MMSI number it is not possible to store any log-files on the internal storage. As long as there is no MMSI, the easyTRX3 is always creating a warning message "MMSI is missing". Additional to this message the yellow warning LED is glowing.

With additional entries for A / B / C / D you can define ship dimensions in relation to the GPS source aboard. If you are using the internal GPS antenna of the easyTRX3 the place you are going to mount the easyTRX3 is the relation point for this.

By using the arrow, you will get back to the center screen.

That's all for general basic settings for participating in the AIS system.

You can close the app.

If you need to change the factory settings to fit your special situation, please join the following instructions.

easyTRX3-Manager 1.0

Developed by



AIS Class B - SOTDMA

Connect	Connected	>
Interfaces		>
Diagnostics	All OK	>
Received Data		>
Anchor Alarm	Not active	>
CPA Alarm	Not active	>
Sent Data		>
Static Data		>

Press on „Interfaces“ to get into more detailed and technical settings for configuration.

8.3.1 Functionality via App

8.3.1.1 Transmitter

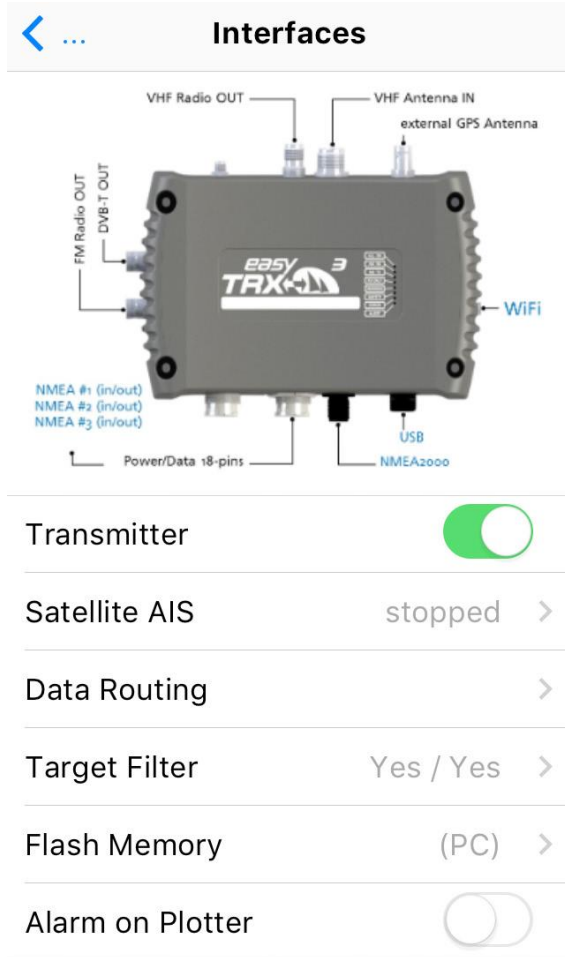

By using the slider-button, you can easily set the easyTRX3 into a pure receiving mode (RX only). From now on the easyTRX3 will not send out any AIS data.

A small window is coming up as a confirmation which you can closed by pressing "OK".

8.3.1.2 Long-Range AIS/Satellite AIS

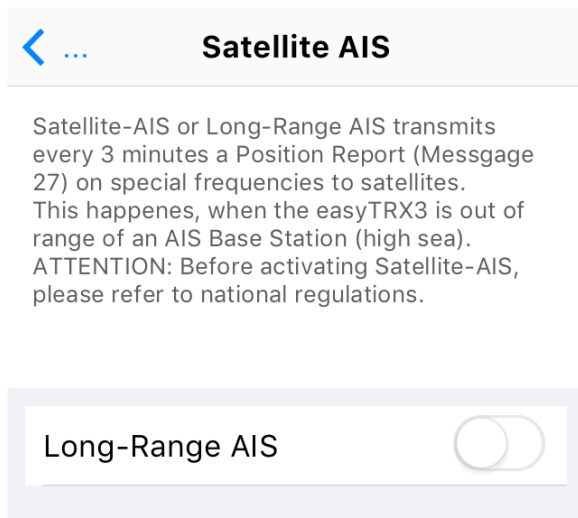

Due to IMO international regulations this functionality is deactivated by default. Long-range AIS is designed for sea-going vessels which are getting out of the range of coastal base stations.

Once the Long-range AIS is activated, every 3 minutes a position report is send out to AIS satellites on special frequencies. The satellites will redirect the received report to coastal base stations. This enables the persistent onshore visibility of vessels on Trans-Atlantic-Trips.

By entering the receiving range of a coastal base station with activated long-range AIS, it might be possible, that the base station shuts down your functionality automatically

because it is permitted in this area. Please inform by yourself in case of using long-range AIS.

Once leaving the range of the base station, and the long-range AIS was activated before the automatic shutdown, the easyTRX3 will re-activate automatically.

As long as you are not charged for satellite data providing costs, the long-range AIS position reports are not shown up at Vesseltracker.com or MarineTraffic. Vice versa there are no additional costs for you if the functionality is activated.

8.3.1.3 Data Routing/Data Configuration



The easyTRX3 has got several data inputs and outputs (ports). Here you can configure each input and output. For each interface port you can select the data source, which shall be send out there.

NMEA-BAUDRATES	
Port #1 (in/out)	<input type="text" value="38400"/>
Port #2 (in/out)	<input type="text" value="38400"/>
Port #3 (in/out)	<input type="text" value="4800"/>

At this point it is selectable with which baud rate the NMEA ports have to work with. You can select between 4800 baud, 38400 baud or even 115200 baud. It is possible to set different baud rates for the different ports.

Important to know:

Each port runs with similar data rate for IN and OUT. This means that it is possible to connect different devices for IN and OUT at the same port, but the baud rate of these connected devices has to be similar.

The following matrix (manufacturer default) is for configuration of device routing. Here you can decide on which port data will be feeded IN and on which port these data have to be forwarded OUT to connected devices.

Change the default routing by clicking into the different cells to display your personal setup aboard.

DATA AT NMEA#1-OUTPUT	
AIS	✓
GPS	✓
NMEA-Input #1	✓
NMEA-Input #2	
NMEA-Input #3	✓
USB-Input	
WIFI-Input	

DATA AT NMEA#2-OUTPUT	
AIS	✓
GPS	✓
NMEA-Input #1	
NMEA-Input #2	
NMEA-Input #3	✓
USB-Input	
WIFI-Input	

Example of manufacturer default:

Baud rate:

- NMEA1: 38400 Baud for IN/OUT
- NMEA2: 38400 Baud for IN/OUT
- NMEA3: 4800 Baud for IN/OUT

Routing:

GPS data were forwarded to

- NMEA1 – e.g. chart plotter
- NMEA2 – e.g. chart plotter
- NMEA3 – e.g. VHF radio
- N2K – board network
- USB – e.g. Laptop or PC
- WiFi – e.g. Tablet or other terminal device

AIS data were forwarded to

- NMEA1 – e.g. chart plotter
- NMEA2 – e.g. chart plotter
- N2K – board network
- USB – e.g. Laptop or PC
- WiFi – e.g. Tablet or other terminal device

INPUT data on NMEA3 (e.g. log or wind) were forwarded to

- NMEA1 – e.g. chart plotter
- NMEA2 – e.g. chart plotter
- USB – e.g. Laptop or PC
- WiFi – e.g. Tablet or other terminal device

Once you found the best personal setting, please press "Save".

DATA AT NMEA#3-OUTPUT

AIS	
GPS	✓
NMEA-Input #1	
NMEA-Input #2	
NMEA-Input #3	
USB-Input	
WIFI-Input	

DATA AT USB-OUTPUT

AIS	✓
GPS	✓
NMEA-Input #1	
NMEA-Input #2	
NMEA-Input #3	✓
WIFI-Input	

DATA AT WIFI-OUTPUT

AIS	✓
GPS	✓
NMEA-Input #1	
NMEA-Input #2	
NMEA-Input #3	✓
USB-Input	

DATA AT NMEA2000-OUTPUT

AIS	✓
GPS	✓

8.3.1.4 Target Filtering

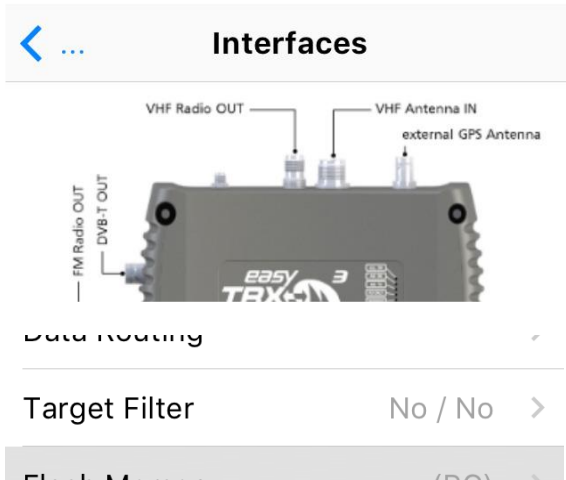

Additional there is the possibility to define and activate a target filter.

With these settings, AIS data from outside the selected distance will no longer be shown on the chart plotters screen.

This might be helpful if you are in areas of very high AIS traffic to reduce the amount of AIS objects on the screen to a clear level.

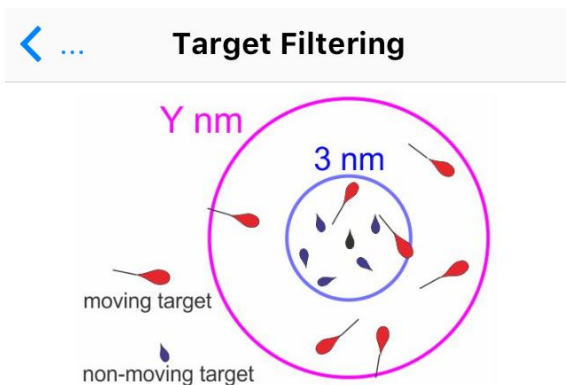

The target filter can be used separately for NMEA and USB/WiFi Output.

It is also possible to use only one of these filters.

Once you have set your personal settings, you can go back with the blue arrow.

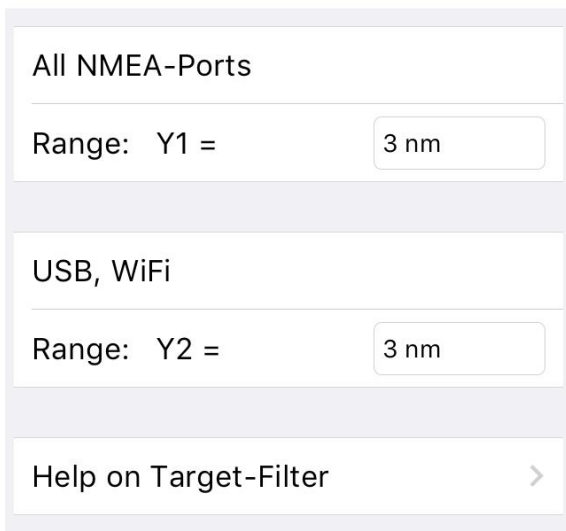

Range Filter:

The range filter has three tasks:

- Within 3 nm all targets (moving and non-moving) will be given to the selected output.
- Within the range between 3 nm and Y nm (programmable by the user) all moving targets are given to the selected output but all non-moving targets are removed.
- Outside the range of Y nm all targets (moving and non-moving) are hidden to the selected output.
- This target filter is only applied to the selected outputs. An unchecked output will deliver all targets!

8.3.1.5 Flash Memory

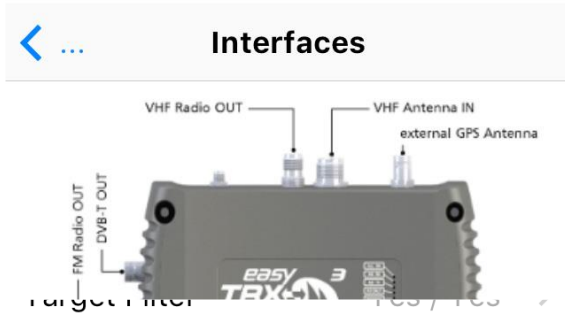

Flash Memory (PC) >

Flash Memory

You can use the internal Flash-Memory for logging of GPS- and AIS-Data and use it as a "Black-Box".
 If you need access to the logging data, you must connect easyTRX3 to a PC using USB connection.
 Then you have to activate "Flash-Drive (PC)".
ATTENTION: When mounted as flash-drive (PC), easyTRX3 has got no access to flash memory and no data will be written to flash memory!
ATTENTION: When you format the Flash-Memory, you will lose all stored data!

Status: Flash-Drive (PC)

- AIS / GPS Logging
- Flash-Drive (on PC)
- Format Flash-Memory

As factory default of the easyTRX3, the AIS and GPS data logging functionality is deactivated. Among others, one reason is that there is no valid MMSI programmed into the easyTRX3.

In so-called "Flash-Drive" mode, via USB cable connectivity it is possible to get access to the internal storage where english User Guide as well as programming software are located.

AIS and GPS data, stored later on, can be read-out in Flash-Drive mode.

To log your AIS and GPS data during your trip, you have to switch from Flash-Drive mode into "AIS Data Logging" mode. Additional you have to activate the logging functionality manually by clicking the button.

Important:
 Please note that the programming software and the User Guide have to be copied locally to your computer before installing. Installation directly from the easyTRX3 internal storage might cause to problems.

In case that you want to format the internal storage for any reason, please use the easyTRX3 software exclusively. Formatting the internal storage will produce a 100% loss of all stored data.

8.3.1.6 Diagnostics

easyTRX3-Manager 1.0

Developed by 



AIS Class B - SOTDMA

- Interfaces >
- Diagnostics All OK >
- Received Data >

Diagnostics

- All OK
- AIS RX
- AIS TX
- RX ONLY
- WARNING
- SAFETY
- ERROR
- ALERT

- [GPS Position...](#) OK / 09 Sat. used >
- [Transmitter](#) OK
- [Receiver](#) OK
- [Supply Voltage Idle](#) 14 V
- [Supply Voltage Tx](#) 12 V
- [Tx Forward Power](#) 412 - OK
- [Tx Reverse Power](#) 123 - OK
- [Temperature](#) 20°C
- [Error Info](#) none
- [Warning Info](#) none
- [Version Info](#) 1.0.13 >

From the center screen you will reach the topic „Diagnostics“.

Within this area you will get an overview about current status of the easyTRX3 and the proper functionality, as well as information about possible Warning Messages or Error Messages.

All status LEDs you know from the top of the easyTRX3 are displayed also within the software.

In the right column you can see short information to these points.

GPS Position

Here you can see an illustration about the current given satellite constellation. Tipp on it and you will get the following display.

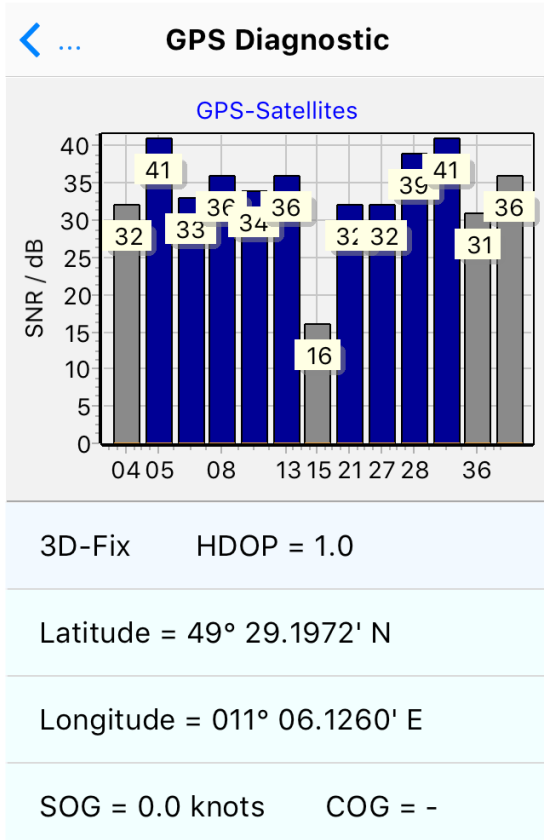

Here an overview is shown about course and speed over ground, the current position, satellites available and in use.

- **Course over Ground:**
Displays the current course over ground of the vessel.
- **Speed over Ground:**
Displays the current speed over Ground of the vessel.
- **Latitude / Longitude:**
Displays the current exact position of the vessel.
- **Satellites in view / Satellites in use:**
Displays how many satellites are available for GPS positioning and how many are used for GPS positioning in reality.
- **HDOP:**
The horizontal dilution of precision display is a term used in satellite navigation and geomatics engineering to specify the additional multiplicative effect of navigation satellite geometry on positional measurement precision. The HDOP benchmark is 2.5. As lower the value, as better it is.
Within the picture below you can see a HDOP value of 1.0 which is very good.

Diagnostics

- All OK
- AIS RX
- AIS TX
- RX ONLY
- WARNING
- SAFETY
- ERROR
- ALERT

- [GPS Position...](#)
OK / 09 Sat. used
- [Transmitter](#)
OK
- [Receiver](#)
OK
- [Supply Voltage Idle](#)
14 V
- [Supply Voltage Tx](#)
12 V
- [Tx Forward Power](#)
412 - OK
- [Tx Reverse Power](#)
123 - OK
- [Temperature](#)
20°C
- [Error Info](#)
none
- [Warning Info](#)
none
- [Version Info](#)
1.0.13

Transmitter

As soon as the transponder has send out data for the first time, the value changes from "standby" to "OK". If there will be a malfunction within the unit, the status will be "Error" and the easyTRX3 is no longer working proper anymore. Please contact your service partner. By means of the Error messages more details are given to you.

Receiver

As soon as the first AIS telegram was send out, the value changes from "standby" to "OK". If there will be a malfunction within the unit, the status will be "Error" and the easyTRX3 is no longer working proper anymore. Please contact your service partner. By means of the Error messages more details are given to you.

Supply Voltage (TX) / Supply Voltage (idle):

This is the voltage value during transmission. For transmitting AIS data, the easyTRX3 takes approx. 2A power for 0.2 seconds. If the used cable are too thin or even too long, the voltage can drop down under the shown "Idle" value which might cause to limited transmission power. To solve the problem, please check the cable connections or use thicker ones.

TX Forward Power / TX Reverse Power:

Both status will be "OK" if a VHF antenna is connected in the right way. If the antenna has got a short circuit or the antenna cable is interrupted, "Error" is shown here. The ration between "forward" and "reverse" has to be 3:1 at least or more. As higher the "forward" value, as better it is. This indicates that most of the power is transmitted.

Error Info

Within the "Error Messages" area there are hints to the possible malfunction of the easyTRX3. These short messages will give more detailed information about the possible

malfunction of the easyTRX3 and will guide you or your service partner to solve the problem.

Warning Info

The warning messages will appear only for a short time until the corresponding configuration has changed. For example: "no valid fix" means that the easyTRX3 has got no GPS position fix up to now. As soon as there is a position fix, this warning message disappears.

Every 30 seconds the easyTRX3 is doing a self-test. Each Error or Warning Message has got a 60 second count-down. If the cause of the message is no longer given within the next self-test, the message disappears. Most of the Error Messages are caused by hardware malfunction and/or cable connection failure. These messages will still appear, event within the next following self-tests.

Version

Here you can see details about the current firmware release version as well as units serial number.

Additional you can initiate a factory reset, if necessary. Please follow the instructions displayed on the screen.

< ...

Version Info

It is a violation of rules of national authorities to use this application to program or delete an MMSI that has not properly assigned to the end user, or to otherwise program any inaccurate data into a device. Factory reset must be carried out by a Weatherdock Dealer. Apply for a one-time PIN by e-mailing the key to "support@weatherdock.de".

Model: easyTRX3, A20000

Production Date: 2018-08-13

Hardware Version: 2

Firmware Version: 1.0.13

Vendor ID: WDC@@@

Serial: 000000000

BSH/4542/001/4323246/18

Factory-Reset (Key / PIN):

Get new Key

Do Factory-Reset

easyTRX3-Manager 1.0

Developed by



AIS Class B - SOTDMA

- Diagnostics All OK ✓
- Received Data >
- Anchor Alarm Not active

<
Received Data
⚙️

AIS Objects found: 1 [Scroll LIST to show additional Ships]

~970236999	0.1 nm >
------------	----------

▲
nm

Map

Received Data

This function gives you an overview about the vessels in your vicinity by means of their received AIS data.

One click on the list displays detailed information of a special vessel.

If you tip on Map, the vessels are displayed relative to your current position. By means of mobile data roaming Google Maps® as layer is also possible.

In case that an activated AIS personal emergency beacon is received, the position of the "man over board" is displayed as a cross with a circle.

☰
Ship-Information
⚙️

~970236999
⊕

MMSI: 970236999
 Call-Sign:
 Destination:
 ETA:
 Type: Ship with no information
 Size: x m
 Draught: -
 Status: unknown

Latitude

49° 29.1977' N

Longitude

011° 06.1248' E

Distance

0.1 nm

Last Report

4:10

SOG

0.0 knots

COG

-

TH

-

Bearing

6°

Map

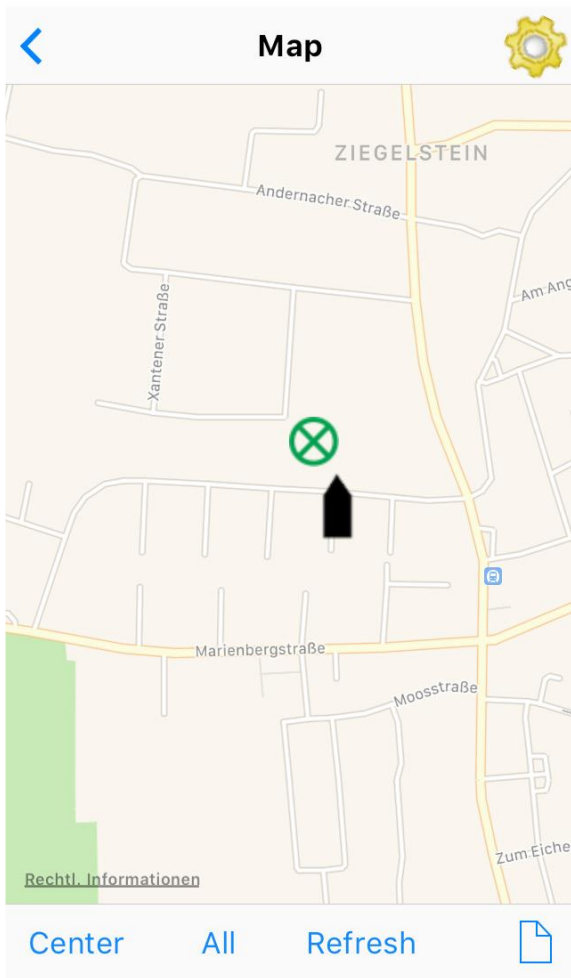

8.3.1.7 Anchor Alert

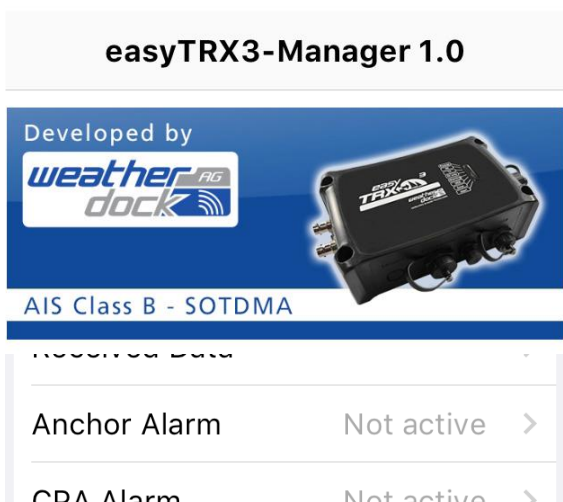

Here it is possible to create a kind of „anchor watch“ functionality by software which is deactivated by default.

You can set a distance as a radius around your anchor position. The radius to set is depending on the sway at anchor of your vessel in wind and current and on the length of your given anchor chain. Within this radius no alert has to be triggered. Once the radius line was step-over, the Alert LED starts to glow.

[< ...](#) **Anchor Alarm**

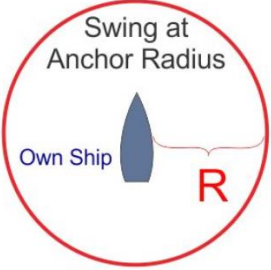

Swing Radius [m]

[ft]

Anchor Alarm

[Help on Anchor Alarm >](#)

To get the daily use of this functionality as convenient as possible, please take a look back to chapter 7.3 “External switches – connecting possibilities” how to use switches and external signal generators.

Please keep in mind that a switch, connected via the 18-pin cable harness (hardware), always takes priority over software programming-settings.

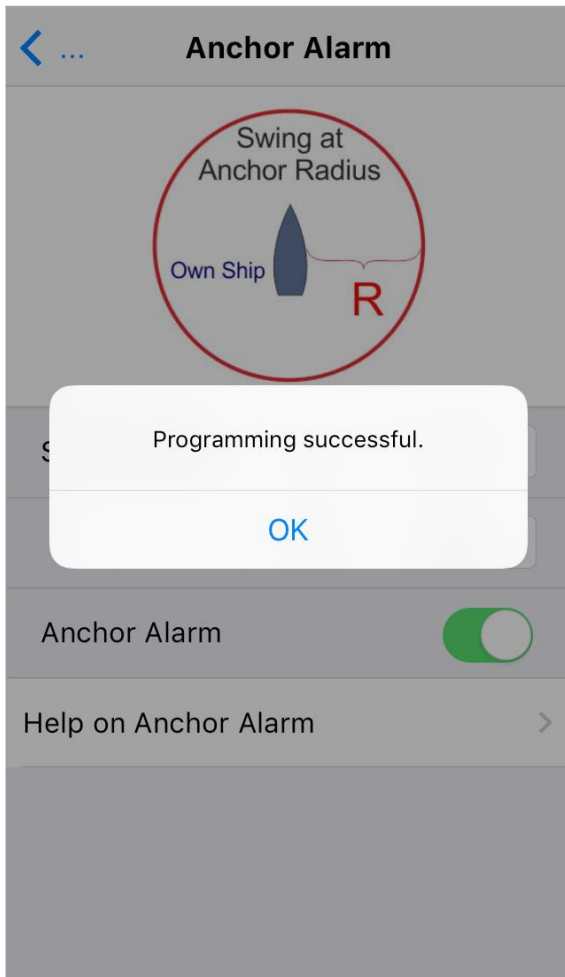

Help

Attention:
 =====
 Anchor-Alarm can only be turned on with valid GPS-Fix! Do not set the radius to a low value. The GPS accuracy may be more than 10-30 meters, depending on satellite constellation or weather conditions. This would cause false alarms.
 In case of no GPS position fix no Alarm will occur!!
 When you turn on the Anchor-Alarm (by programming or switch), the actual GPS position is used as anchor position.

8.3.1.8 CPA Alarm



The CPA (Closest Point of Approach) alert functionality was developed to avoid collisions due to low visibility at night or bad weather conditions.

You can create your own "safety area" around your vessel by activating time- and distance settings.

Usually CPA settings **are set** at the chart plotter. But the chart plotter has to be switch on all the time during the trip to keep the CPA functionality running. This might cause to a power supply problem aboard because chart plotters often need a lot of power. But during a long-term-trip it is absolutely needful to reduce power consumption to a minimum.

CPA Alarm

Closest Point of Approach (CPA)

The diagram illustrates the Closest Point of Approach (CPA) between two vessels. A blue vessel labeled 'Own Ship' is moving to the right. A red vessel labeled 'Target' is moving to the left. A horizontal line represents the path of 'Own Ship'. A vertical dashed line indicates the 'CPA' (Closest Point of Approach) distance. A bracket above the horizontal line indicates the 'Time to CPA'.

Time-to-CPA [min] < 5 >

CPA [meters] < 2000,16 >

CPA Alarm

Help on CPA >

The big advantage of the easyTRX3 is that it has got an own internal CPA functionality and the chart plotter doesn't need to be switched on. All incoming AIS position reports will be investigated regarding the CPA settings done in this programming tool. In event of receiving a position report within the self-defined "safety area" which means potential collision, the Alert LED starts to glow.

To get the daily use of this functionality as convenient as possible, please take a look back to chapter 7.3 "External switches – connecting possibilities" how to use switches and external signal generators.

Please keep in mind that a switch, connected via the 18-pin cable harness (hardware), always takes priority over software programming-settings.

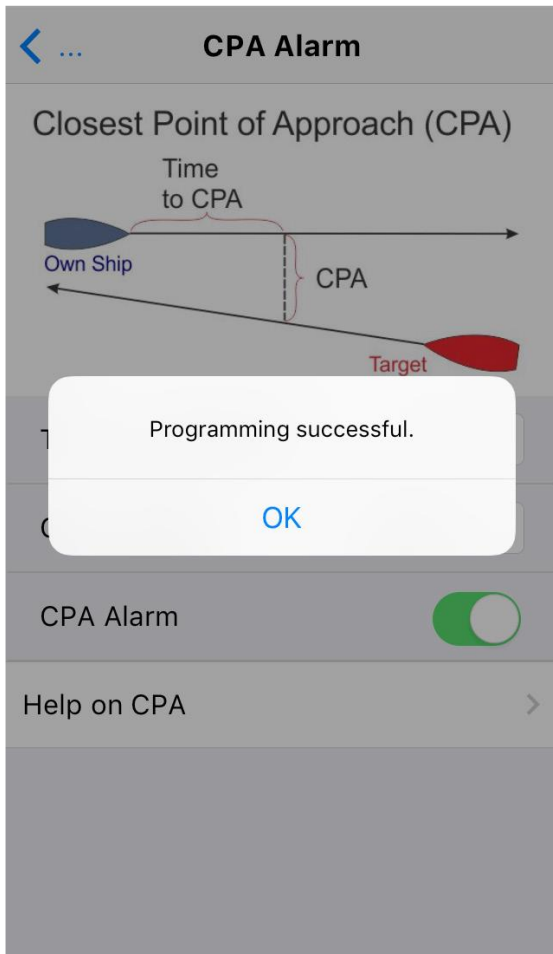

Help

Description:

=====
 Closest Point of Approach is closest distance two vessels will come to each other based on their current course and speed calculated by AIS.

Time-to-CPA [min]:

=====
 For setting the minutes how far the other ship at least should be before the CPA Alarm goes off.

CPA [meters]:

=====
 For setting the meters how far the other ship at least should be before the CPA Alarm goes off.
 Resolution is 1/100 nautical mile (= 18.52 m).
 You can choose from 18.52 m to 2000.16 m.

8.3.1.9 Sent Data

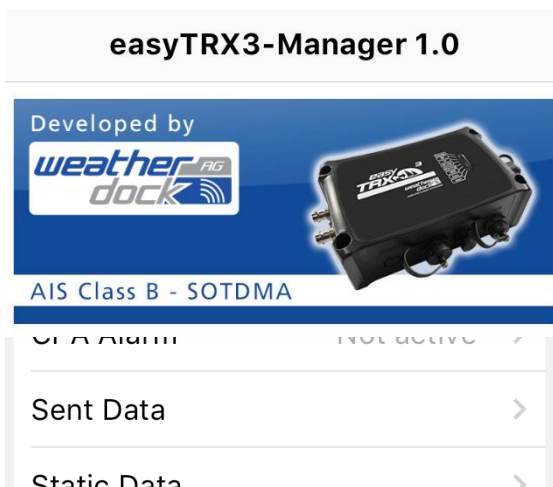

Sent Data

Gives you an overview about all information the easyTRX3 is transmitting into the AIS system regarding your vessel.

You can see the AIS position report your MMSI, course and speed over ground and more.

Additional you can see all the "static AIS data" your easyTRX3 is transmitting.

Sent Data	
AIS-POSITION REPORT	
INTERVALS: 3 MIN, 30 S, 15 S, 5 S DEPENDING ON SPEED	
MMSI	211002010
Latitude	49° 29.1976' N
Longitude	011° 06.1258' E
Course over ground	360.0 deg T
Speed over ground	0.0 knots
AIS-Channel	B
Last Transmission	2:54

Sent Data	
AIS-STATIC DATA (EVERY 6 MINUTES)	
MMSI	211002010
Ship's Name	WD MK
Type of ship	Sailing Vessel
Vendor ID	WDCD
Call Sign	WD MK
Dimension A	8 m
Dimension B	8 m
Dimension C	2 m
Dimension D	2 m
AIS-Channel	B

9 Modular Built-up

9.1 IS - integrated VHF antenna splitter

The integrated VHF antenna splitter enables to use the existing VHF antenna for VHF radio also for AIS transmission and reception. This prevents the additional installation of a second antenna on top of the mast.

The splitter will manage the parallel running of VHF radio and AIS, but gives VHF radio priority. The received signals will be amplified before splitting to avoid physical signal loss.

The VHF radio always has a connection to the antenna, even if the easyTRX3 is switched off.

9.2 IGPS – integrated GPS antenna

For GRP or wooden hull boats it is possible to use the integrated GPS antenna instead of installing on deck. Steel or aluminium hull boats have to use an external GPS antenna mounted on deck.

9.3 N2K – integrated NMEA2000 module

The N2K connection plug is designed to forward the received AIS and GPS data into the NMEA2000 board net. Up to now there is one-directional communication.

The following list shows all AIS messages which should be converted.

PGN	Description
059392	ISO Acknowledgement
060928	ISO Address Claim
059904	ISO Request
060160	ISO Transport Data Transfer
060416	ISO Transport Connection Management
126208	NMEA Request/Command/Acknowledge Group Function
126464	PGN List
126992	System Time
126996	Product Information
129025	Position Rapid update
129026	COG & SOG Rapid update
129038	AIS Class A Position Report
129039	AIS Class B Position Report
129040	AIS Class B Extended Position Report
129794	AIS Class A Static and Voyage Related Data
129798	AIS SAR Aircraft Position Report
129802	AIS Safety Related Broadcast Message
129809	AIS Class B "CS" Static Data Report, Part A
129810	AIS Class B "CS" Static Data Report, Part B

9.4 WiFi - integrated WiFi module (optional)

While using the corresponding product variant, all data feeded into the easyTRX3 are forwarded via WiFi connectivity to mobile terminal devices, e.g. smartphones or tablet. The module is ready for up to 40 mobile clients connected to the easyTRX3 simultaneously.

9.5 DVBT - integrated frequency splitter for TV signal and FM radio (optional)

This optional product variant enables to separate the encrypted DVB-T2 signals by a frequency splitter. These signals were forwarded to a connected DVB-T2 receiver. The reception of these signals will be realized via the existing VHF antenna you are already using for VHF radio and AIS. To receive DVB-T2 or FM radio signals, the easyTRX3 must be switched on.

Attention, there must not be another splitter between the antenna and the easyTRX3, because the DVBT2 frequencies may be completely disconnected and therefore nothing can be received or amplified by the easyTRX3.

10 Installation of the easyTRX3 aboard

Before mounting, please check GNSS window in Programming-Tool or App if you receive a good GPS signal before fixing the unit on board. Otherwise change the position of the easyTRX3 or use an external GPS antenna.

If you want to mount the easyTRX3 under-deck, you have to take care that the unit will be strictly above waterline because of the integrated GPS antenna – in case you are going to use it. Keep in mind of the potential slope of the vessel when sailing close-hauled course.

The easyTRX3 is ready for outside mounting by means of IP67.

Please pay attention that the easyTRX3 has to be mounted with at least 40 cm distance to a compass or other technical equipment.

11 Technical Data

Description	Value
General	
Dimensions	195mm * 135mm * 60mm (L*B*H)
Weight	700 Gramm
Operating temperature	-15°C bis 55°C
Storage temperatur	-20°C bis 75°C
Safety distance compass	mind. 40 cm
Power Specification	
Board voltage	12V DC / 24V DC
Operating voltage range	9,6 bis 31,2V DC
Input	2,9W bei 12V DC
Current consumption	2A (Senden), -240mA (Stand.) bei 12V DC
GNSS Specification	
GPS/GNSS Receiver (internal)	72 Channel GNSS Receiver
	# GPS
	# GLONASS
	# GALILEO
External Connections	
Interfaces	3x NMEA0183 IN
	3x NMEA0183 OUT
	NMEA2000
Connections (standard version)	USB
	18 pin plug
	NMEA2000 socket
	external GPS antenna (BNC)
	VHF antenna connection (SO239)
	VHF connection (TNC)

Data type NMEA output	VDM
Options	WiFi, DVB-T2, Sensor, DAB, GSM
AIS Specification	
Transmitter	1 Tranmitter (AIS1/AIS2)
Receiver	2 Receiver (AIS1/AIS2)
	DSC (AIS Channel Management)
Frequencies	Marine Band: 156,025MHz - 162,025MHz
	AIS1: 161,975MHz
	AIS2: 162,025MHz
Transmission Power	5Watt / 1Watt (50Ohm)
Channel width/grid	25kHz
Modulation	GMSK (AIS, TX and RX)
Transmission rate	FSK (DSC, RX only)
	9600b/s (AIS)
	1200b/s (DSC)
Sensitivity	-114dBm 25kHz (<20% PER)
Co-channel rejection	10dB
Adjacent channel rejection	70dB
Intermodulation	65dB
Blocking	84dB
Certifications	
AIS Standards	IEC 62287-2:2017
Environmental	IEC 60945:2002 + Corr.1:2018
GPS Performance	IEC 61108-1:2003
Product Safety	EN 60950-1:2006
	ITU-R M.1371-5
BSH approval	BSH/4542/001/4323246/18

12 Circuit diagram proposal

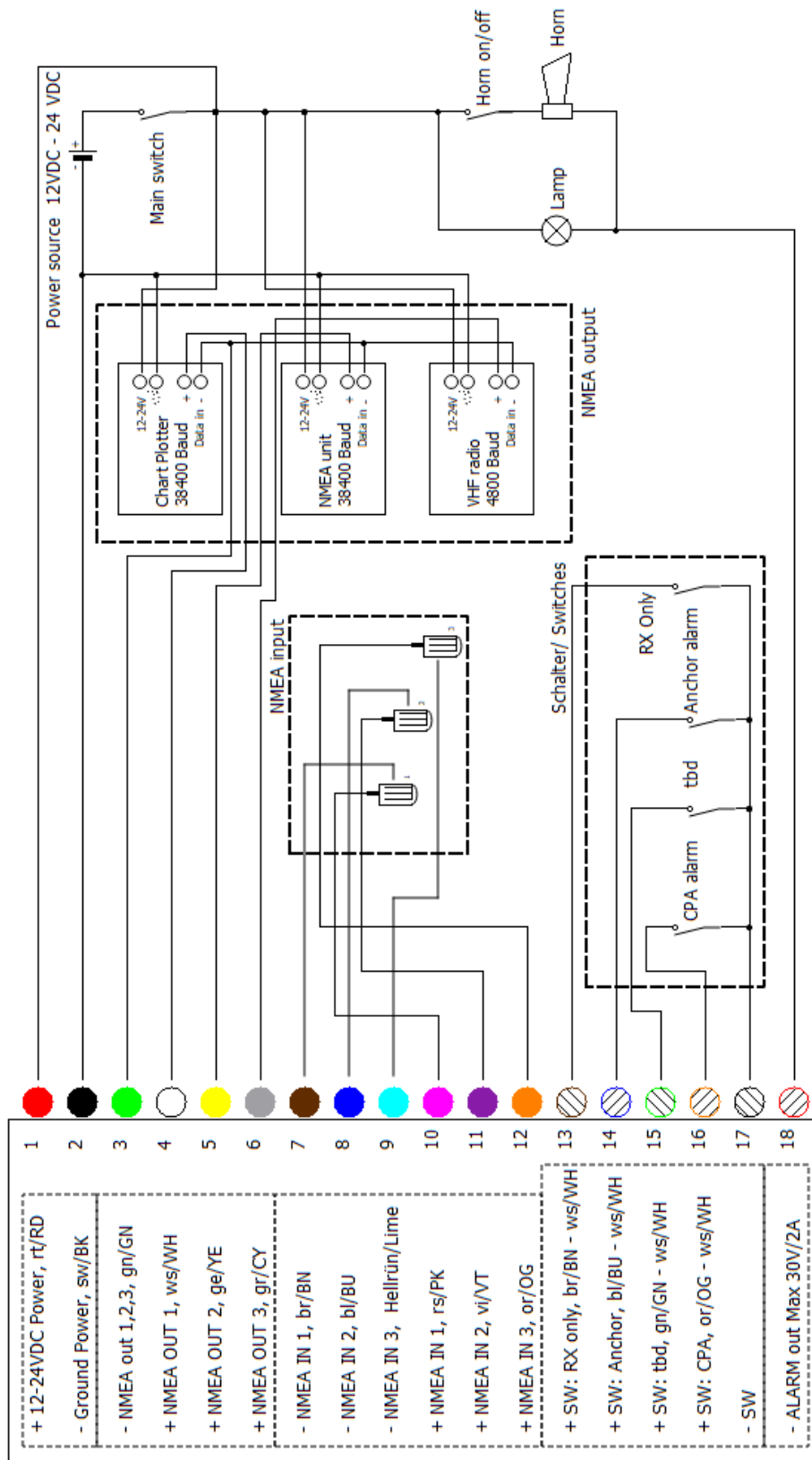

13 Troubleshooting

Problem	Cause	Solution
no connection possible to easyTRX3	<ul style="list-style-type: none"> • USB cable not plugged correctly • USB driver not installed. 	<p>Make sure, there is an internet connection, so the PC can download the USB driver.</p> <p>Try to use another USP-Port, we recommend an USB-Hub with its own power supply.</p>
	Proper configuration?	repeat configuration, perhaps you have to ask your service partner.
No data output	not connected	<p>Please check if cable colours are correct for connection.</p> <p>Is data output of the easyTRX3 connected with chart plotter data input?</p> <p>Please check baud rate of NMEA output where chart plotter is connected to.</p>
Input of MMSI not possible	Perhaps already done?	Only 1 MMSI usage is possible. For entering a different MMSI, please ask your service partner.
Red Error LED glows	different errors possible	<p>Please connect with the programming software and look out for „Diagnostics“.</p> <p>If you can't solve the problem, please contact your service partner.</p>

14 Error Codes/Warning Codes

Code	Group	Text	Meaning
001	Error	AIS: TX malfunction	
002	Error	AIS: Antenna VSWR exceeds limit	please check coaxial cable to your antenna and also connectors, too much power is reflected and that error is generated
003	Error	AIS: RX channel 1 malfunction	no AIS reception on Channel A, 161.975MHz
004	Error	AIS: RX channel 2 malfunction	no AIS reception on Channel B, 162.025MHz
005	Error	AIS: RX channel 70 malfunction	
007	Error	AIS: UTC Sync invalid	no GPS position
026	Error	AIS: no GPS since 30min	no GPS position
029	Error	AIS: no valid SOG information	no GPS position
030	Error	AIS: no valid COG information	no GPS position
050	Warning	AIS: GPS: no valid fix	no GPS position
051	Warning	AIS: High supply voltage	supply voltage more than 31.2V in idle mode
054	Warning	AIS: Base station has stopped TX	AIS Base station stopped your AIS Transmission within an local area, will be activated after a while or when you leave that area.
055	Warning	AIS: No MMSI	Due to no programmed MMSI, there is no AIS transmission, please fill in your MMSI
072	Error	AIS: low supply voltage	supply voltage less then 9,6V in idle mode
073	Error	AIS: low supply voltage while sending	due to thin cable or bad battery, the voltage drops on AIS transmission
077	Error	AIS: Device overheated	unit is getting too warm and will shut down e.g. WiFi to reduce currend and cooling down
078	Error	AIS: Baseband fail	

15 Maintenance

The easyTRX3 product line does not contain parts that require maintenance. Avoid using chemical solvents to clean the easyTRX3 as some solvents can damage the case material. Unauthorized opening of the device will invalidate the warranty.

16 Contact and support information

Although WEATHERDOCK strives for accuracy in all its publications; this material may contain errors or omissions, and is subject to change without prior notice.

Frequently asked questions (FAQ):

You find them here: www.easyais.com/en/faqs/

Contact:

Contact your local dealer for WEATHERDOCK AIS support in most cases he can help quickly and straightforwardly.

If he cannot help you we are happy to provide help solving your problem:

Weatherdock AG
Emmericher Strasse 17
90411 Nürnberg
Tel: +49 911-37 66 38 30
support@weatherdock.de
www.easyAIS.de

Please do not send an apparently defective device to us without prior consultation. In most cases the problem can be solved via telephone or email.

17 License agreement

By using the easyTRX3 you agree to be bound by the conditions of the following warranty. Please read this carefully.

Weatherdock AG grants you a limited license to use this device in normal operation. Titles, property rights as well as intellectual property rights contained in and of the software remaining Weatherdock AG.

18 Warranty

Weatherdock AG grants a warranty of 2 years from the date of purchase for defects in material or workmanship of this product. Within this period Weatherdock will at its sole option repair or replace any components that fail in normal use. Such repairs or replacement will be made at no charge to the customer for parts or labor, provided that the customer shall be responsible for any transportation cost. This warranty does not cover failures due to abuse, misuse, accident or unauthorized alteration or repairs. The warranties and remedies contained herein are exclusive and instead of all other warranties express or implied or statutory, including any liability arising under any warranty of merchantability or fitness for a particular purpose, statutory or otherwise. In no event shall Weatherdock be liable for any incidental, special, indirect or consequential damages, whether resulting from the use, misuse or inability to use this product or from defects in the product. Weatherdock retains the exclusive right to repair or replace the unit or software or offer a full refund of the purchase price at its sole discretion. Such remedy shall be your sole and exclusive remedy for breach of warranty.

Products purchased in online-auctions do not entitle you to deductions or to the use of Weatherdock's special offers. Furthermore we do not accept purchase confirmations from online auctions as evidence for warranty claims. An original receipt is compulsory for satisfaction of warranty claims. Weatherdock does not replace missing device or accessory parts in products which were purchased in online auctions. In a warranty case please contact your Weatherdock dealer. He will agree on the next steps with you. In the case of dispatch pack up the device properly and send it sufficiently stamped to the address stated by your dealer. For warranty repair always enclose a copy of your original sales receipt for evidence of ownership. The Weatherdock AG easyTRX3 does not contain parts which have to be repaired. If you have a problem with your device, please contact your easyTRX3 dealer. Any attempt to open, alter or modify the device will invalidate warranty and may damage the device irreparably.

19 Warning

It is the sole responsibility of the owner/operator of the ship to command the vessel safely and to be in full control of all operating conditions during the entire travel time. By mistaken conduct of the operator of a ship equipped with a device from the easyTRX3 product line if the operator does pay undivided attention to operation and surrounding condition damage or personal injury may be caused in the event of an accident.

The responsibility rests on the user alone to use the easyTRX3 prudently. The easyTRX3 does not relieve you from duty of care!

Therefore good seamanship is still essential.

20 Notices

INDEX

- Advance setting screen 20, 21
- Advanced 19
- Advanced Settings 19
- AIS Data Logging 65
- AIS Data Logging 32
- AIS Data Logging 30
- AIS messages 77
- AIS Specification 80
- AIS transmitter settings 25
- AIS-Transmitter 24
- Alarm on Plotter 26
- Anchor Alert 12, 29
- Anchor Alert 29
- Anchor Alert 11, 28, 57, 71
- anchor watch 28, 71
- App 54, 55, 60
- Basic Setup 17, 18
- Basic setup screen 18, 19
- baud rate 20
- baud rates 61
- Baud rates 20
- Board voltage** 79
- BSH approval** 80
- BSH approval number 3
- cable colours 10, 82
- Certifications 80
- Circuit diagram 81
- Closest Point of Approach 73
- COM-Port 16
- Connection 16, 24, 52
- Connection screen 17
- Contact 84
- Course over Ground 45, 67
- CPA 3
- CPA Alert 11, 27, 57
- CPA settings 27, 28, 73, 74
- Current consumption** 79
- data flow 17
- Data type NMEA output** 80
- Diagnostic screen 42, 43
- Diagnostics 42, 66
- diameter 44
- Dimensions** 79
- Distance Filter 22
- Distance Filter 23
- DVBT 78
- Dynamic Data 46
- easyTRX3-Manager 54, 55
- Error Codes 83
- Error Messages** 44, 66, 68
- External Connections 79
- External signal generator 13
- External Switches 10
- factory default setting 40
- Factory reset 49
- FAQ 84
- Factory reset 48
- Firmware Update 50
- Firmware Update 51
- Flash-Drive 65
- Flash-Memory** 19
- Formatting 32, 33, 65
- frequencies 26, 60
- Frequencies** 80
- GNSS 3, 43, 45, 79
- GNSS position fix 43
- GNSS Specification 79
- GPS Position 66
- GPS signal-strength 46
- GPS Status screen 46
- GPS/GNSS Receiver** 79
- Hardware Status 44
- HDOP 3, 45, 67
- Host** 52, 55
- Host-IP address 52
- Index of Abbreviations 3
- Info / Update 48
- Input** 79
- installation 77
- Installation 19, 65
- Installation of the easyTRX3 aboard 78
- integrated GPS antenna 77
- integrated NMEA2000 module 77
- integrated VHF antenna splitter 77
- integrated WiFi module 78
- Interfaces 19, 20, 59, 79
- Internal Memory 30
- LAN 3
- Latitude / Longitude 45, 67
- License agreement 84
- Long-range 26
- Long-Range AIS 60
- long-range satellite AIS 46
- Maintenance 84
- manufacturer default 21, 62
- MMSI 18

- MMSI number 57
- MMSI 3
- Modular Built-up 77
- NMEA 3
- Older 26
- Operating temperature** 79
- Operating voltage range** 79
- Password 52, 55
- pin-code 48, 50
- Port** 55
- Port number 52
- ports 20, 61
- Power Specification 79
- Preparations 14
- problem 84
 - 82
- Read-out stored AIS data 14
- Received Data 47, 70
- Receiver 43
- Rescan 36
- router 34
- Router Setup 35
- routing 20
- Routing 61
- RX only 12, 58, 60, 80
- RXonly 24
- Safety distance compass** 79
- Satellite AIS 26, 60
- Satellites in view / Satellites in use 45,
 - 67
- Scope of Delivery 7
- self-tests 26
- Sensitivity** 80
- Sent Data 46, 75
- ship list 47
- Silent mode 24
- Speed over Ground 45, 67
- SSID 3, 52, 55
- start screen 16
- static AIS data** 75
- Static Data 46, 57
- status LEDs 44, 66
- Storage temperatur** 79
- Supply Voltage** 68
- Supply Voltage (TX) / Supply Voltage (idle) 44
- Target Filter 64
- Technical Data 79
- Transmission Power** 80
- Transmitter 43
- trip data 32
- Troubleshooting 82
- TRX Status 43
- TX Forward Power** 68
- TX Reverse Power** 68
- USB Connection 15
- USB driver 82
- Valid MMSI 43
- Version 69
- VHF 3
- VHF Antenna 44
- VSWR 3, 44
- Warning 85
- Warning Codes 83
- warning LED 58
- Warning Messages** 44, 66
- Warranty 85
- Weight** 79
- WiFi 3
- WiFi Configuration 34
- WiFi connection 52
- WiFi Connection and App via mobile terminal device 54
- WiFi Connection to a Laptop 52
- WiFi module 37
- WLAN network 34
- Warning Messages 69

Emmericher Strasse 17
90411 Nürnberg – Germany
+49 (0)911 – 37663830
info@weatherdock.de
support@weatherdock.de
www.easyAIS.com



EXCELLENCE IN RADIO TECHNOLOGIES
Safety • Navigation • Tracking

