

SIMRAD

AP48

Operator Manual

ENGLISH



Preface

Disclaimer

As Navico is continuously improving this product, we retain the right to make changes to the product at any time which may not be reflected in this version of the manual. Please contact your nearest distributor if you require any further assistance.

It is the owner's sole responsibility to install and use the equipment in a manner that will not cause accidents, personal injury or property damage. The user of this product is solely responsible for observing safe boating practices.

NAVICO HOLDING AS AND ITS SUBSIDIARIES, BRANCHES AND AFFILIATES DISCLAIM ALL LIABILITY FOR ANY USE OF THIS PRODUCT IN A WAY THAT MAY CAUSE ACCIDENTS, DAMAGE OR THAT MAY VIOLATE THE LAW.

Governing Language: This statement, any instruction manuals, user guides and other information relating to the product (Documentation) may be translated to, or has been translated from, another language (Translation). In the event of any conflict between any Translation of the Documentation, the English language version of the Documentation will be the official version of the Documentation.

This manual represents the product as at the time of printing. Navico Holding AS and its subsidiaries, branches and affiliates reserve the right to make changes to specifications without notice.

Trademarks

Navico® is a registered trademark of Navico Holding AS.

Simrad® is used by license from Kongsberg.

NMEA® and NMEA 2000® are registered trademarks of the National Marine Electronics Association.

Copyright

Copyright © 2017 Navico Holding AS.

Warranty

The warranty card is supplied as a separate document.

In case of any queries, refer to the brand website of your display or system: www.simrad-yachting.com.

Compliance statements

This equipment complies with:

- CE under EMC directive 2014/30/EU
- The requirements of level 2 devices of the Radio communications (Electromagnetic Compatibility) standard 2008

The relevant Declaration of conformity is available in the product's section at the following website: www.simrad-yachting.com.

About this manual

This manual is a reference guide for operating the AP48. It assumes that all equipment is installed and configured, and that the system is ready to use.

The manual assumes that the user has basic knowledge of navigation, nautical terminology and practices.

Important text that requires special attention from the reader is emphasized as follows:

→ **Note:** Used to draw the reader's attention to a comment or some important information.

⚠ Warning: Used when it is necessary to warn personnel that they should proceed carefully to prevent risk of injury and/or damage to equipment/personnel.

Manual version

This manual is written for software version 1.0. The manual is continually updated to match new software releases. The latest available manual version can be downloaded from www.simrad-yachting.com.

Contents

7 Introduction

- 8 AP48 Front panel and keys
- 9 The autopilot page

11 Basic operation

- 11 Safe operation with the autopilot
- 11 Turning the unit on and off
- 12 Sleep mode
- 12 Operating the menu system
- 13 Display setup

14 Autopilot modes

- 14 Selecting an autopilot mode
- 14 Standby mode
- 14 Non-Follow Up (NFU) mode
- 14 Follow-up (FU) mode
- 15 AUTO mode (Heading hold)
- 16 WIND mode
- 17 WIND Nav mode
- 17 NoDrift mode
- 18 Heading capture
- 19 NAV mode
- 21 Turn pattern steering
- 25 Using the autopilot in an EVC system

26 Trip log

27 Alarms

- 27 Alarm indication
- 27 Type of messages
- 27 Acknowledging the alarms
- 28 Enabling the alarm system and the alarm siren
- 29 Alarm history
- 29 List of alarms

30 Software setup

- 30 Calibration
- 35 Damping

| | |
|-----------|--|
| 36 | Autopilot settings |
| 42 | System settings |
| 48 | Maintenance |
| 48 | Preventive maintenance |
| 48 | Cleaning the display unit |
| 48 | Checking the connectors |
| 48 | Backup and restore of system data |
| 49 | Software update |
| 50 | Menu tree |
| 52 | Technical specifications |
| 54 | Dimensional drawings |
| 54 | AP48 without bracket |
| 54 | AP48 with bracket |
| 55 | Supported data |
| 55 | NMEA 2000 PGN (transmit) |
| 55 | NMEA 2000 PGN (receive) |
| 57 | Appendixes |
| | List of possible alarms and corrective actions |

1

Introduction

The AP48 is a networked autopilot display and control unit.

The unit is compatible with a range of Navico autopilot computers, including AC12N, AC42N, NAC-2, NAC-3 and SG05 autopilot computers.

The AP48 systems include several modules that need to be mounted in different locations on the vessel and that need to interface with at least three different systems on the boat:

- The boat's steering system
- The boat's electrical system (input power)
- Other equipment onboard

All parts of the autopilot system must be installed and configured according to supplied documentation prior to using the autopilot. The following steps are required:

- Mechanical installation and wiring of all units. Refer to separate documentation for the units
- Software setup of the system. Refer to "*Software setup*" on page 30
- Commissioning and setup of the autopilot computer. Refer to the installation and commissioning documentation for your autopilot computer

AP48 Front panel and keys

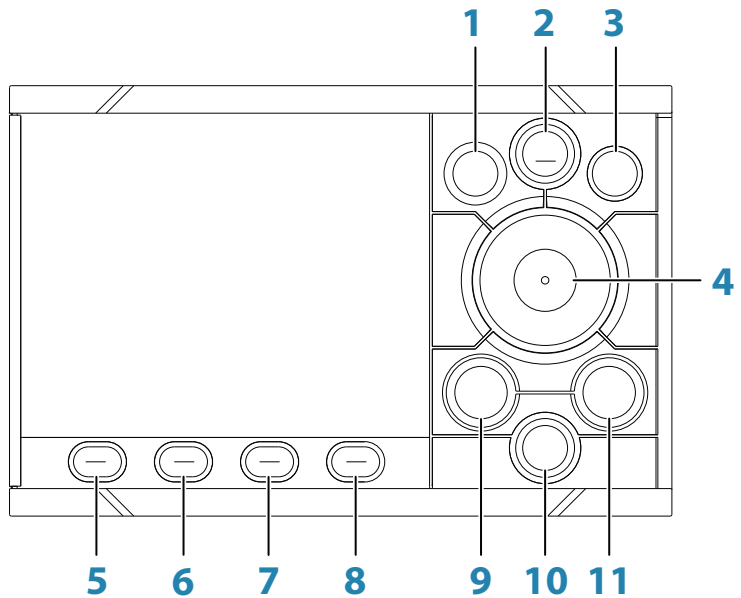

- 1** Power key
 - Press to show the Display Setup dialog. Repeat short presses to toggle preset light levels
 - Press and hold to put the autopilot system to Sleep mode. Repress the key to activate the system
- 2** **MENU** key
Press to show the Settings menu
- 3** **X** key
Press to return to previous menu level or to exit a dialog

4 Rotary knob

Menu and dialog operation:

- Turn to move up and down in menus and dialogs
- Turn to adjust a value
- Press to select a menu option and to enter the next menu level

In Standby mode or Non Follow Up (NFU) mode: Press to activate the Follow up (FU) mode

In FU mode: Turn to set the rudder angle

In automatic modes: Turn to change the set heading/set course/set wind angle

5 - 8 < 10, < 1 and 1 >, 10 > (Port and starboard keys)

In Standby or FU mode: Press to activate NFU mode

In NFU mode: Press to control the rudder

In automatic modes: Press to change the set heading/set course/set wind angle 1° or 10° to port or starboard

9 **STBY** key

Press to activate Standby mode

10 **MODE** key

Press to show the Mode list

11 **AUTO** key

Press to activate AUTO mode

The autopilot page

The content of the autopilot page varies with active mode. All modes include:

- Response (AC12N/AC42N/SG05) / Profile (NAC-2/NAC-3) mode **(A)**
- Heading indicator, analog and digital **(B)**
- Autopilot mode indication **(C)**
- Rudder indicator, analog and digital **(D)**

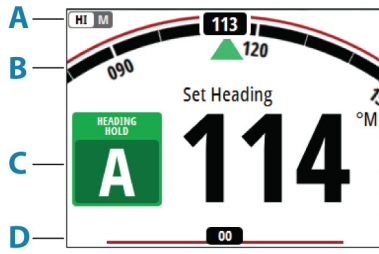

For more information, refer to *"Autopilot modes"* on page 14.

2

Basic operation

Safe operation with the autopilot

⚠ **Warning:** An autopilot is a useful navigational aid, but DOES NOT replace a human navigator.

⚠ **Warning:** Ensure the autopilot has been installed correctly, commissioned and calibrated before use.

Do not use automatic steering when:

- In heavy traffic areas or in narrow waters
- In poor visibility or extreme sea conditions
- When in areas where use of an autopilot is prohibited by law

When using an autopilot:

- Do not leave the helm unattended
- Do not place any magnetic material or equipment near the heading sensor used by the autopilot system
- Verify at regular intervals the course and position of the vessel
- Always switch to Standby mode and reduce speed in due time to avoid hazardous situations

Turning the unit on and off

The unit will be running as long as power is connected to the NMEA 2000 backbone. It is possible to put the unit to Sleep mode, refer to "*Display setup*" on page 13.

First time startup

When the unit is started for the first time and after a factory reset, the unit displays a setup wizard. Respond to the setup wizard prompts to select some fundamental setup options. These settings can later be changed and further configuration made as described in "*Software setup*" on page 30.

Sleep mode

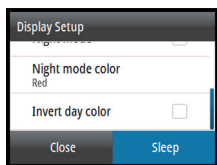

In Sleep mode, the backlight for screen and keys are turned off to save power. The system continues to run in the background.

To enter Sleep mode press and hold the power key or select Sleep from the Display Setup dialog activated by pressing the power key. Switch from Sleep mode to normal operation by a short press on the power key.

→ **Note:** The system will automatically switch to Standby mode when Sleep mode is activated.

Operating the menu system

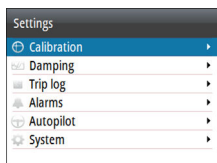

All settings and configuration in the unit are available from the Settings menu, activated by pressing the **MENU** key.

- Turn the rotary knob to move up and down in the menus and in the dialogs
- Confirm a selection by pressing the rotary knob
- Return to previous menu level by pressing the **X** key

Edit a value

1. Turn the rotary knob to select the entry field
2. Press rotary knob to turn the field into edit mode
 - The left digit starts flashing
3. Turn the rotary knob to set the value for the flashing digit
4. Press the rotary knob to move focus to the next digit
5. Repeat step 3 and 4 until all digits are set
6. Press the rotary knob to leave edit mode for the selected field

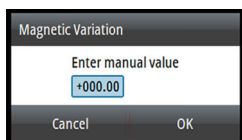

Selected field

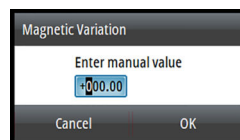

Field in edit mode

→ **Note:** You can at any time press the **X** key to leave a dialog.

Display setup

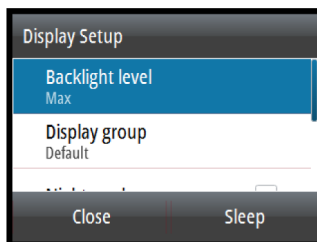

The display setup can be adjusted at any time from the Display Setup dialog, activated by pressing the power key.

The following options are available:

- Backlight level: Adjusts the backlight level from Min (10%) to Max (100%) in 10% increments
 - When the Backlight level field is active, subsequent presses on the power key adjusts backlight level in decrements of 30%
 - Display group: Defines which network group the unit belongs to
 - Night mode: Activates/deactivates the night mode color palette
 - Night mode color: Sets the night mode color palette
 - Invert day color: Changes the background color for the pages from default black to white
 - Sleep: Turns the backlight for screen and keys off to save power
- **Note:** All changes made to the display setup will apply to all units belonging to the same display group. For more information about network groups, refer to "*Network groups*" on page 45.
- **Note:** The system will switch to Standby mode when Sleep mode is activated.

3

Autopilot modes

The autopilot has several steering modes. The number of modes and features within the mode depend on the autopilot computer, the boat type and available inputs, as explained in the description of the following steering modes.

Selecting an autopilot mode

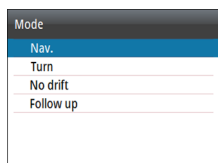

You select Standby mode and AUTO mode by pressing the dedicated **STBY** and **AUTO** keys.

You select other modes and automatic features by selecting the relevant option from the Mode list, activated by pressing the **MODE** key.

Standby mode

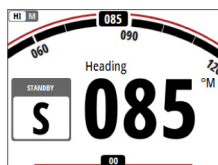

Standby mode is used when you steer the boat at the helm.

- Switch to Standby mode by pressing the **STBY** key.
- **Note:** If sensor data vital for autopilot operation (e.g. rudder response) is lost when the autopilot is running in an automatic mode, the system will automatically switch to Standby mode.

Non-Follow Up (NFU) mode

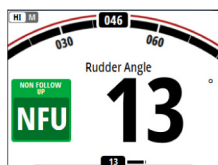

In NFU mode you can use the port and starboard keys on the controller to operate the rudder. The rudder will move as long as the key is pressed.

- Switch to NFU mode by pressing one of the port or starboard keys when the autopilot is in Standby mode or FU mode.

Follow-up (FU) mode

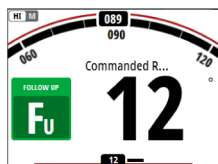

In FU mode you turn the rotary knob to adjust the set rudder angle.

The rudder will move to the commanded angle and then stop.

- Switch to FU mode from any mode by selecting the Follow-up option in the Mode list, or switch directly from Standby mode or NFU mode to FU mode by pressing the rotary knob.

AUTO mode (Heading hold)

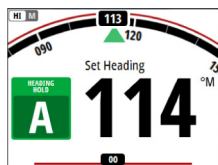

In AUTO mode the autopilot issues rudder commands required to steer the vessel automatically on a set heading. In this mode the autopilot does not compensate for any drifting caused by current and/or wind (**A**).

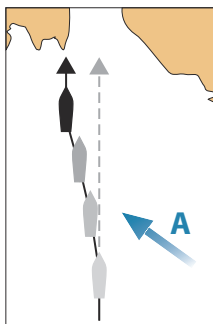

- Switch to AUTO mode by pressing the **AUTO** key

When the mode is activated, the autopilot selects the current boat heading as the set heading.

Changing set heading in AUTO mode

You adjust the set heading by turning the rotary knob or by pressing the port or starboard keys.

An immediate heading change takes place. The new heading is maintained until a new heading is set.

Tacking and Gybing in AUTO mode

→ **Note:** Only available when the boat type is set to SAIL.

Tacking and Gybing in AUTO mode uses the heading as reference. The tacking/gybing operation changes the set heading to port or starboard with a fixed angle.

The tacking parameters are set in the Setup/Sailing parameters: The **Tack angle** defines the tacking angle, while the **Tack time** defines the rate of turn during the tack/gybe. Refer to "*Autopilot settings*" on page 36.

- Initiate the Tack or Gybe function by selecting the **Tack/Gybe** option in the Mode list.
 - The turn is started when the direction is selected in the dialog.

WIND mode

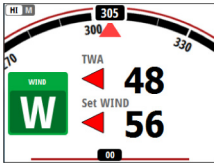

- **Note:** Wind mode is only available when the boat type is set to SAIL. It is not possible to activate wind mode if wind information is missing.

When wind mode is engaged, the autopilot captures the current wind angle as steering reference, and adjusts the heading of the boat to maintain this wind angle.

- Switch to Wind mode by selecting the Wind option in the Mode list

⚠ Warning: In wind mode the autopilot steers to the apparent or true wind angle and not to a compass heading. Any wind shift could result in the vessel steering on an undesired course.

Changing set wind angle in Wind mode

You adjust the set wind angle by turning the rotary knob or by pressing the port or starboard keys.

Tacking and Gybing in Wind mode

Tacking and Gybing in Wind mode can be performed when sailing with apparent or true wind as the reference. In either case the true wind angle must be less than 90 degrees (tacking) and more than 120° (gybing).

The tacking/gybing operation will mirror the set wind angle on the opposite tack.

The rate of turn during the tack/gybe is set by the **Tack time** in the Setup/Sailing menu. Refer to "*Autopilot settings*" on page 36.

- Initiate the Tack or Gybe function by selecting the **Tack/Gybe** option in the Mode list.
- Confirm the tack/gybe in the dialog.

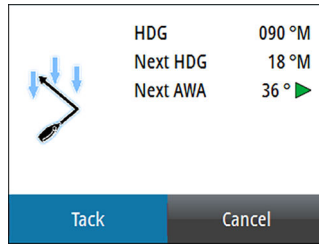

- **Note:** The autopilot will temporarily add a 5 degree bear-away on the new tack to allow the boat to pick up speed. After a short period the wind angle will return to the set angle.
- **Note:** If the Tack/Gybe is not confirmed the dialog will close after 10 seconds, and the requested tack/gybe will not be initiated.

WIND Nav mode

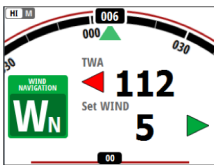

- **Note:** The WIND Nav mode is only available if the system has been set up for boat type Sail. This mode is not available for NAC-2 or NAC-3 autopilot computers.

In WIND Nav mode the autopilot steers the boat given both wind and position data.

In this mode the autopilot calculates the initial course change needed to navigate towards the active waypoint, but the pilot also utilizes the current wind direction in the calculation.

NoDrift mode

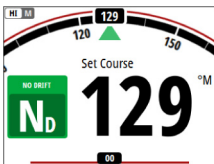

- **Note:** It is not possible to select NoDrift mode if GPS position and heading information is missing.

In NoDrift mode the vessel is steered along a calculated track line, from present position and in a direction set by the user. If the vessel is drifting away from the track line due to current and/or wind (**A**), the vessel will follow the line with a crab angle.

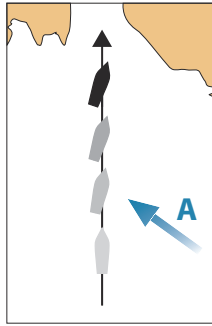

- Switch to NoDrift mode by selecting the NoDrift option in the Mode list

When the mode is activated, the autopilot will draw an invisible track line based on current heading from the vessel's position.

The autopilot will now use the position information to calculate the cross track distance, and automatically steer along the calculated track.

Changing set course in NoDrift mode

You adjust the set course by turning the rotary knob or by pressing the port or starboard keys.

An immediate course change takes place. The new course is maintained until a new course is set.

Dodging

→ **Note:** Only available for AC12N/AC42N autopilot computers.

If you need to avoid an obstacle when using NoDrift mode, you can set the autopilot to Standby mode and power steer or use the helm until the obstacle is passed.

If you return to NoDrift mode within 60 seconds you can select to continue on previous set bearing line.

If you do not respond, the dialog disappears and the autopilot goes to NoDrift mode with current heading as set bearing line.

Heading capture

When the vessel is turning in AUTO mode, an instant re-press on the **AUTO** key or the rotary knob activates the heading capture

function. This will automatically cancel the turn, and the vessel will continue on the heading read from the compass the very moment you pressed the **AUTO** key or the rotary knob.

NAV mode



→ **Note:** NAV mode requires a compatible navigator connected to the network.

It is not possible to select NAV mode if heading information is missing, or if steering information is not received from the external chartplotter.

⚠ Warning: NAV mode should only be used in open waters. Navigation mode must not be used while sailing, as course changes may result in unexpected tacks or gybes!

In NAV mode the autopilot uses steering information from an external navigator to direct the vessel to one specific waypoint location, or through a series of waypoints.

In NAV mode, the autopilot's heading sensor is used as heading source for course keeping. Speed information is taken from SOG or from selected speed sensor. The steering information received from the external navigator alters the set course to direct the vessel to the destination waypoint.

To obtain satisfactory navigation steering, the autopilot system must have valid input from the navigator. Autosteering must be tested and determined satisfactory prior to entering NAV mode.

→ **Note:** If the navigator does not transmit a message with bearing to next waypoint, the autopilot will steer using Cross Track Error (XTE) only. In that case you must revert to AUTO mode at each waypoint and manually change set course to equal bearing to next waypoint and then select NAV mode again.

Prior to entering NAV mode the navigator must be navigating a route or towards a waypoint.

- Initiate NAV mode by selecting the NAV option in the Mode list
- Confirm to switch to NAV mode in the dialog.

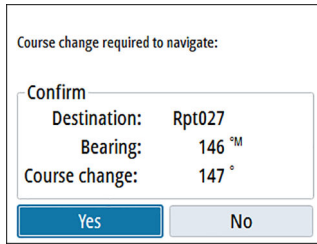

Turning in NAV mode

When your vessel reaches a waypoint, the autopilot will give an audible warning and display a dialog with the new course information.

There is a user defined limit for the allowed automatic course change to next waypoint in a route. If the course change is more than this set limit, you are prompted to verify that the upcoming course change is acceptable.

- If the required course change to the next waypoint is less than the course change limit, the autopilot will automatically change the course. The dialog will disappear after 8 seconds unless cleared by the **X** key.
- If the required course change to next waypoint is more than the set limit, you are prompted to verify that the upcoming course change is acceptable. If the turn is not accepted, the vessel will continue with the current set heading.

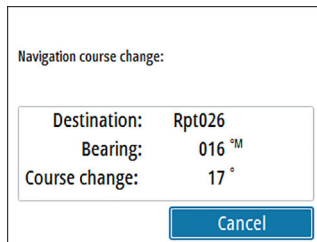

Course change less than set limit

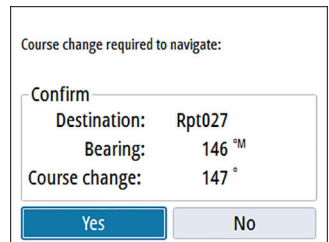

Course change larger than set limit

The course change limit setting depends on the autopilot computer:

- NAC-2/NAC-3: **Course chg confirm angle**, refer to "*Steering (NAC-2/NAC-3)*" on page 37
- AC12N/42N and SG05: **Navigation change limit**, refer to "*Automatic steering (AC12N/AC42N)*" on page 41

Turn pattern steering

The system includes a number of automatic turn steering features when the autopilot is in AUTO mode.

→ **Note:** Turn pattern steering is not available if the boat type is set to Sail. Instead the tack/gybe feature is implemented.

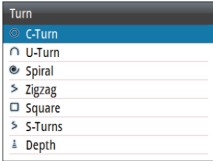

Turn variables

All turn patterns, except the U-turn, have settings that you adjust before you start a turn or at any time when the boat is in a turn.

The turn settings are available from the Autopilot settings dialog. The variables are described for each turn pattern option in the following pages.

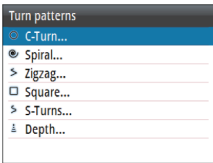

Starting and stopping a turn

→ **Note:** For starting a DCT turn, see "*Depth contour tracking (DCT)*" on page 23.

You start the turn by selecting the turn option in the Mode list, followed by selecting the port or starboard options in the turn dialog to select the turn direction.

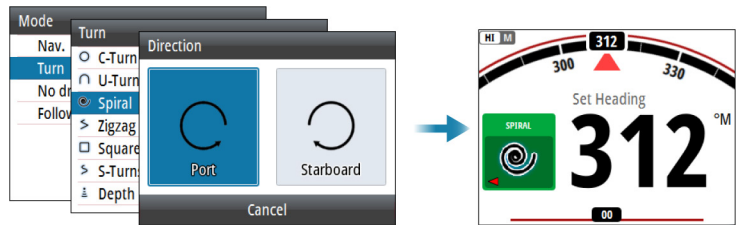

You can at any time stop the turn by pressing the **STBY** key to return to Standby mode and manual steering.

C-turn (Continuous turn)

Steers the vessel in a circle.

- Turn variable:
 - Rate of turn. Increasing the value makes the vessel turn a smaller circle.

U-turn

Changes the current set heading to be 180° in the opposite direction.

The turn rate is identical to Turn rate (NAC-2/NAC-3) and Rate limit (AC12N/AC42N) setting (refer to "*Autopilot settings*" on page 36). The turn rate cannot be changed during the turn.

Spiral turn

Makes the vessel turn in a spiral with a decreasing or increasing radius.

- Turn variables:
 - Initial radius
 - Change/turn. If this value is set to zero, the boat will turn in a circle. Negative values indicate decreasing radius while positive values indicate increasing radius.

Zigzag turn

Steers the vessel in a zigzag pattern.

During the turn you can alter the main heading by turning the rotary knob or by pressing the port or starboard keys (only for AC12N/AC42N autopilot computers).

- Turn variables:
 - Course change (**A**)
 - Leg distance (**B**)

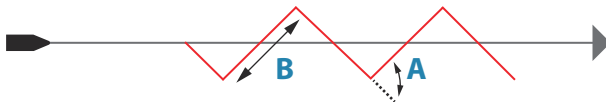

Square turn

Makes the vessel automatically turn 90° after having travelled a defined leg distance.

During the turn you can alter the main heading by turning the rotary knob or by pressing the port or starboard keys (only for AC12N/AC42N autopilot computers).

- Turn variable:
 - Leg distance

S-turn

Makes the vessel yaw around the main heading.

- Turn variables:
 - Course change (**C**)
 - Turn radius (**D**)

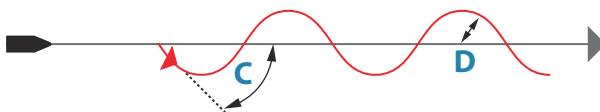

During the turn you can alter the main heading by turning the rotary knob or by pressing the port or starboard keys (only for AC12N/AC42N autopilot computers).

Depth contour tracking (DCT)

Makes the autopilot follow a depth contour (only for NAC-2/NAC-3 autopilot computers).

- **Note:** DCT turn pattern is only available if the system has a valid depth input.

⚠ Warning: Do not use the DCT turn pattern unless the seabed is suitable. Do not use it in rocky waters where the depth is varying significantly over a small area.

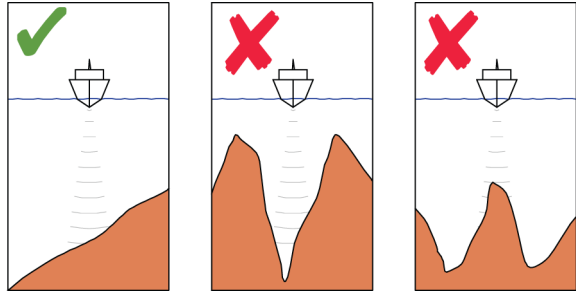

To initiate a DCT turn:

- Ensure that you have depth reading on the panel or on a separate depth instrument
- Steer the boat to the depth you want to track, and in the direction of the depth contour
- Activate AUTO mode, then select depth contour tracking while monitoring the depth reading
- Select the port or starboard option in the turn dialog to initiate the depth contour steering to follow the bottom sloping to starboard or to port

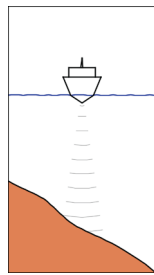

*Port option
(depth decreases to port)*

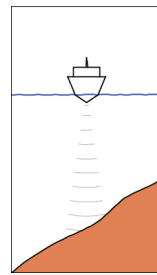

*Starboard option
(depth decreases to starboard)*

- Turn variables:
 - Depth gain. This parameter determines the ratio between commanded rudder and the deviation from the selected depth contour. The higher depth gain value the more rudder is applied. If the value is too small it will take a long time to compensate for drifting off the set depth contour, and the autopilot will fail to keep the boat on the selected depth. If the

value is set too high the overshoot will increase and the steering will be unstable.

- CCA. The CCA is an angle that is added to or subtracted from the set course. With this parameter you can make the boat yaw around the reference depth with S-movements. The larger the CCA the bigger yawing will be allowed. If the CCA is set to zero there is no S-ing.
- Ref. depth. This is the reference depth for the DCT function. When DCT is initiated the autopilot reads the current depth and set this as the reference depth. The reference depth can be changed when the function is running.

→ **Note:** If depth data is lost during DCT the autopilot will automatically switch to AUTO mode.

It is recommended to turn ON the AP Depth Data Missing alarm when using DCT. When this alarm is activated an alarm will be raised if the depth data is lost during DCT.

Using the autopilot in an EVC system

When the AP48 is connected to an EVC system via the SG05, you can take manual control of the steering regardless of the autopilot mode.

The mode indicator is replaced by a dash to indicate EVC override.

The system returns to AP48 control in Standby mode if no rudder command is given from the EVC system within a predefined period.

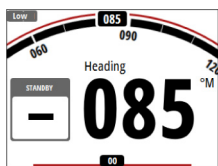

4

Trip log

The Trip log is available from the Settings menu.

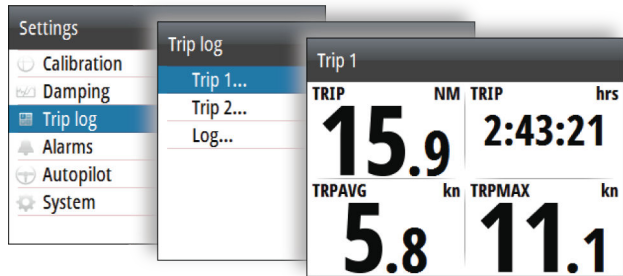

There are three log options available:

- Trip 1: records distance traveled through the water (Log input)
- Trip 2: records distance traveled via GPS input
- Log: shows total distance run from system installation or from a system restore

→ **Note:** Trip 1 requires correctly calibrated boat speed for accurate trip records.

Trip 2 requires a compatible GPS connected to the network.

You start, stop and reset the active Trip log from the menu, activated by pressing the **MENU** key.

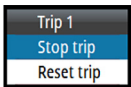

5

Alarms

The system continuously checks for dangerous situations and system faults while the system is running. The alarm system can be activated if any alarm settings are exceeded.

→ **Note:** If sensor data vital for autopilot operation (e.g. rudder response) is lost when the autopilot is running in an automatic mode, the system will automatically switch to Standby mode.

Alarm indication

An alarm situation is indicated with an alarm pop-up. If you have enabled the siren, the alarm message is followed by an audible alarm.

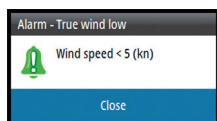

A single alarm is displayed with the name of the alarm as the title, and with details for the alarm.

If more than one alarm is activated simultaneously, the alarm pop-up can display 2 alarms. The alarms are listed in the order they occur with the alarm activated first at the top. The remaining alarms are available in the Alarms dialog.

Type of messages

The messages are classified according to how the reported situation affects your vessel. The following color codes are used:

| Color | Importance |
|--------|---------------|
| Red | Critical |
| Orange | Important |
| Yellow | Standard |
| Blue | Warning |
| Green | Light warning |

Acknowledging the alarms

The most recent alarm is acknowledged by pressing the rotary knob.

This removes the alarm notification, and silences the alarm from all units that belong to the same alarm group.

→ **Note:** An alarm received from non Navico units on the network must be acknowledged on the unit generating the alarm.

Enabling the alarm system and the alarm siren

You enable the alarm system and the alarm siren from the Alarms menu.

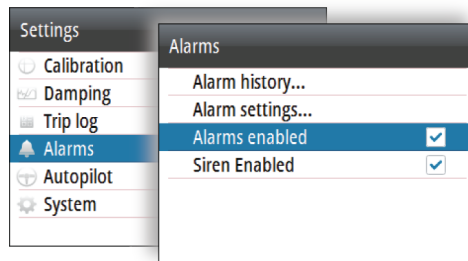

Individual alarm settings

You enable/disable the single alarm and set the alarm limits from the Alarms settings dialog.

- Press the rotary knob to display the menu from where you can enable/disable the alarm and set the alarm limit

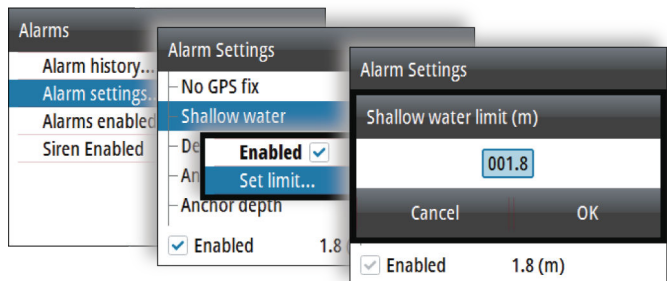

Alarm history

The Alarm history dialog stores alarm messages.

You show alarm details for a selected alarm and clear all alarms in the alarm history by pressing the rotary knob when the Alarm history dialog is active.

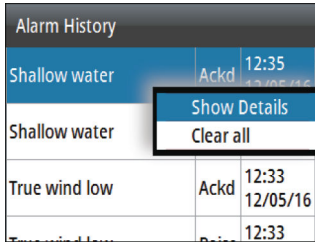

The screenshot shows the 'Alarm History' dialog with a list of alarms. A context menu is open over the first 'Shallow water' entry, showing 'Show Details' and 'Clear all' options. The table below represents the data shown in the dialog.

| Alarm Name | Status | Time |
|---------------|--------|----------|
| Shallow water | Ackd | 12:35 |
| Shallow water | | |
| True wind low | Ackd | 12:33 |
| | | 12/05/16 |
| | | 12:33 |

Menu options

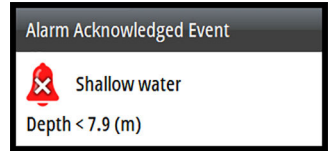

Alarm details

List of alarms

For a list of possible alarms and corrective actions refer to "*Appendixes*" on page 57.

The unit might also display alerts received from other units connected to the system. Refer to separate documentation for the relevant equipment for further description of these alarms.

6

Software setup

Prior to use, the AP48 requires a number of settings be configured in order for the system to perform as expected.

Access to the required options are found in the Settings menu, accessed by pressing the **MENU** key.

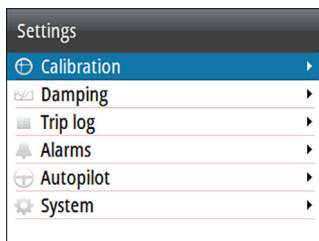

→ **Note:** The following settings are described in other sections of this manual:

"Trip log" on page 26

"Alarms" on page 27

Calibration

→ **Note:** Once the unit is setup and before you proceed with calibration ensure all network sources are selected and configured. Refer to "*System settings*" on page 42.

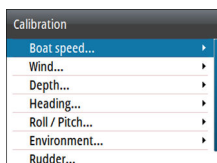

Boat speed

Speed calibration is necessary to compensate for hull shape and paddlewheel location on your boat. For accurate speed and log readings, it is essential that the paddlewheel is calibrated.

SOG reference

This is an auto calibration option that uses speed over ground (SOG) from your GPS, and compares the average of SOG against the average boat speed from the speed sensor for the duration of the calibration run.

→ **Note:** This calibration should be made in calm sea with no effect from wind or tidal current.

- Bring the boat up to cruising speed (above 5 knots), then
- Select the **SOG reference** option

When the calibration is completed the Boat speed calibration scale will show the adjusted percentage value of the boat speed.

Distance reference

Allows you to calibrate the log via a distance reference. You will need to complete consecutive runs, under power at a constant speed made along a given course and distance.

- **Note:** The distance should be greater than 0.5 NM, ideally 1 NM. To eliminate the effect of tidal conditions it is advisable to perform at least two runs, preferably three, along the measured course.

Referring to the diagram, **A** and **B** are the markers for each run. **X** is the actual distance for each run.

- Enter the desired distance in nautical miles that you would like to calculate the distance reference over
- When the boat gets to the predetermined starting position of the distance reference calculation, start the calibration timer
- As the boat passes marks **A** and **B** on each run, instruct the system to start and stop and finally OK to end calibration.

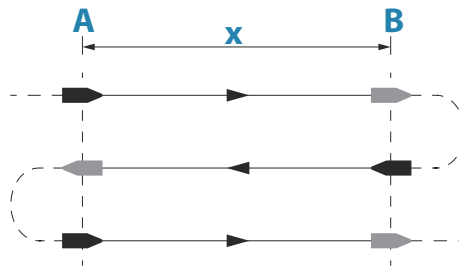

Use SOG as boat speed

If boat speed is not available from a paddle wheel sensor, it is possible to use speed over ground from a GPS. SOG will be displayed as boat speed and used in the true wind calculations and the speed log.

Wind

MHU (Masthead unit) alignment

This provides an off set calibration in degrees to compensate for any mechanical misalignment between the masthead unit and the center line of the vessel.

To check the masthead unit alignment error we recommend you use the following method which involves a sailing trial:

- Sail on a starboard tack on a close hauled course and record the wind angle, then repeat the process on a port tack
- Divide the difference between the two recorded numbers and enter this as the wind angle off set

If the starboard apparent wind angle is greater than the port angle, then divide the difference by 2 and enter this as a negative offset.

If the port angle is greater than the starboard then divide the difference by 2 and enter this as a positive offset.

Enter the offset it into the MHU Align calibration field.

Depth

Depth offset

All transducers measure water depth from the transducer to the bottom. As a result, water depth readings do not account for the distance from the transducer to the lowest point of the boat (for example; bottom of the keel, rudder, or propeller) in the water or from the transducer to the water surface.

- For depth below keel (**A**): Set the distance from transducer to the bottom of the keel as a negative value. For example, -2.0.
- For depth below transducer (**B**): no offset required.
- For depth below surface (waterline) (**C**): Set the distance from transducer to the surface as a positive value. For example, +0.5.

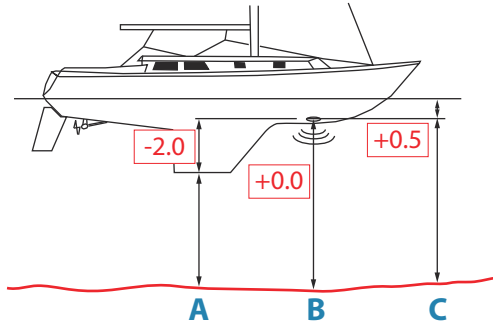

Aft depth offset

This option allows the system to display two depth readings.

The Aft depth is calibrated in the same manner as the Depth offset.

- **Note:** Aft Depth is only available when a valid signal is received from a second and compatible NMEA 2000 or NMEA 0183 device.

Heading

- **Note:** All magnetic compasses must be calibrated to ensure correct heading reference.

The calibration must be made on the active compass.

The calibration should be done in calm sea conditions and with minimal wind and current to obtain good results.

Offset

The **Offset** option is used for compensating for any difference between the boat's center line (A) and the compass lubber line (B).

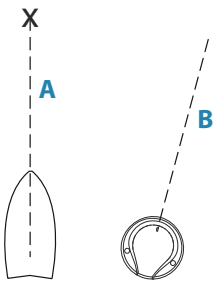

1. Find the bearing from the boat position to a visible object. Use a chart or a chart plotter
2. Steer the boat so that the center line of the boat is aligned with the bearing line pointing towards the object.
3. Change the offset parameter so that the bearing to the object and the compass readout becomes equal.

- **Note:** Make sure that both the compass heading and the bearing to the object have the same unit ($^{\circ}$ M or $^{\circ}$ T).

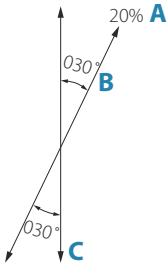

User triggered calibration

→ **Note:** Before the calibration is started, make sure that there is enough open water around the vessel to make a full turn.

The **Calibrate** option is used for manually starting the heading calibration procedure.

During this calibration, the compass measures the magnitude and direction of the local magnetic field.

The illustration shows magnitude of local field in percentage of earth's magnetic field (**A**), direction of local field (**B**) with respect to the boat's centerline (**C**).

Follow the on-screen instruction, and use about 60-90 seconds to make a full circle. Keep turning until the system reports a pass.

- If the local magnetic field is stronger than the earth's magnetic field (the local field is reading more than 100%), the compass calibration will fail.
- If the local field is reading more than 30%, you should look for any interfering magnetic objects and remove them, or you should move the compass to a different location. The (local) field angle guides you to the local interfering magnetic object.

→ **Note:** In certain areas and at high latitudes the local magnetic interference becomes more significant, and heading errors exceeding $\pm 3^\circ$ may have to be accepted.

Automatic calibration

An auto calibration option is available for compasses that offers a fully automatic calibration procedure.

See more instructions in the documentation delivered with your compass.

Magnetic variation

Defines how magnetic variation is handled by the system.

- Auto: Receives variation data from a network source
- Manual: Used for manually entering a value for the magnetic variation

Use COG as heading

If heading data is not available from a compass sensor, it is possible to use COG from a GPS. COG will be used in the true wind calculations.

→ **Note:** The autopilot cannot be operated using COG as the heading source. COG cannot be calculated when stationary.

Pitch/Roll

If a suitable sensor is fitted, the system will monitor the inclination of the vessel. The offset value should be entered to adjust the readings so that while the vessel is stationary at the dock, the **Pitch** and **Roll** value reads 0.

Environment

If a suitable sensor is fitted, the system will monitor the current sea/air temperature and barometric pressure.

The offset value to be entered should adjust the reading from the sensor to match a calibrated source.

Rudder

Starts the automatic calibration of the rudder feedback. This procedure sets the correct relationship between the physical rudder movement and the rudder angle readout.

Follow the instructions on the display to perform the rudder feedback calibration procedure.

Advanced

This option is used for manually applying an offset to the displayed data for third party sensors which cannot be calibrated through the AP48.

Damping

If data appears erratic or too sensitive, damping may be applied to make the information appear more stable. With damping set to off, the data is presented in raw form with no damping applied.



| Damping | |
|---------------|---------|
| Heading | 1 sec ▾ |
| Apparent wind | 4 sec ▾ |
| True wind | 4 sec ▾ |
| Boat speed | 4 sec ▾ |
| SOG | 1 sec ▾ |
| COG | 1 sec ▾ |
| Attitude Roll | 1 sec ▾ |

Autopilot settings

The autopilot settings can be split between settings done by the user, and settings done during installation and commissioning of the autopilot system.

- User settings can be changed for various operational conditions or user preferences
- Installation settings are defined during commissioning of the autopilot system. No changes should later be done to these settings

Both user settings and installation settings depends on which autopilot computer that is connected to the system.

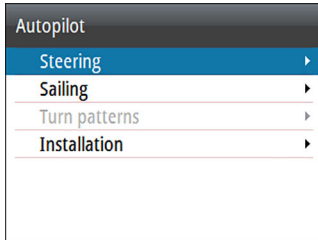

NAC-2/NAC-3 Autopilot computer settings

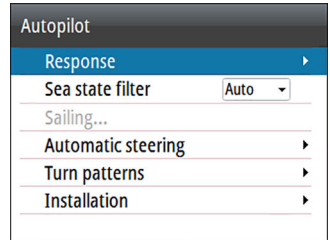

AC12N/AC42N Autopilot computer settings

The following sections describe the settings that can be changed by the user. The settings are described per autopilot computer.

Installation settings are available in the documentation following the autopilot computers.

→ **Note:** For Turn pattern settings, refer to "*Turn pattern steering*" on page 21.

NAC-2/NAC-3 Autopilot computer

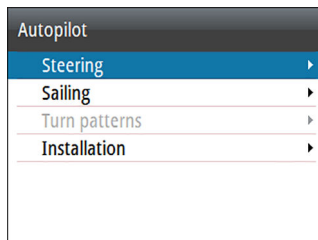

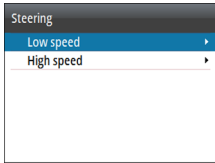

Steering (NAC-2/NAC-3)

These options allow for manually changing parameters that were set during the commissioning of the autopilot computer. For more details, refer to the separate documentation for the autopilot computer.

- Turn rate: Preferred turn rate used while turning in degrees per minute
 - Rudder gain: This parameter determines the ratio between commanded rudder and the heading error. The higher rudder value the more rudder is applied. If the value is too small it will take a long time to compensate for a heading error, and the autopilot will fail to keep a steady course. If the value is set too high the overshoot will increase and the steering will be unstable.
 - Counter rudder: Relation between change in heading error and applied rudder. Higher counter rudder will reduce applied rudder faster when approaching the set heading
 - Autotrim: Controls how aggressively the autopilot will apply rudder to compensate for a constant heading offset, e.g. when external forces such as wind or current affects the heading. Lower autotrim will give faster elimination of a constant heading offset
- **Note:** In VRF mode this parameter controls the time constant of the rudder estimate. A lower value makes the rudder estimate faster, i.e. that it will more quickly catch up with the boat's movements.
- Init rudder: Defines how the system moves the rudder when switching from manual steering to an automatic mode.
 - Center: Moves the rudder to zero position
 - Actual: Maintains the rudder offset
 - Rudder limit: Determines the maximum rudder movement in degrees from midship position that the autopilot can command the rudder in the automatic modes. The Rudder limit setting is only active during autosteering on straight courses, NOT during course changes. Rudder limit does not affect Non-Follow-up steering

- Off heading limit: Sets the limit for the off heading alarm. An alarm occurs when the actual heading deviates from the set heading more than the selected limit
- Track response: Defines how fast the autopilot shall respond after having registered a cross track distance
- Track approach angle: Defines the angle used when the vessel is approaching a leg. This setting is used both when you start navigating and when you use track offset
- Course change confirm angle: Defines the limits for course change to next waypoint in a route. If the course change is more than this set limit, you are prompted to verify that the upcoming course change is acceptable.

Sailing (NAC-2/NAC-3)

→ **Note:** Sailing parameters are only available when the boat type is set to Sail.

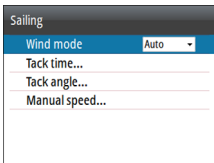

- Wind mode: Select what wind function the autopilot will use when in wind mode
 - Auto:
 - If TWA is $<70^\circ$: Wind mode will use AWA
 - If TWA is $\geq 70^\circ$: Wind mode will use TWA
 - Apparent
 - True
- Tack time: Controls the rate of turn (tack time) when performing a tack in wind mode.
- Tack angle: Controls the angle that the boat will tack to between 50° - 150° in AUTO mode
- Manual speed: If neither boat speed or SOG data is available and or deemed reliable a manual value for speed source can be entered and used by the autopilot to aid steering calculations

AC12N/AC42N Autopilot computer

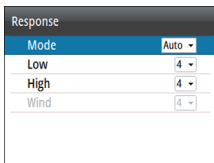
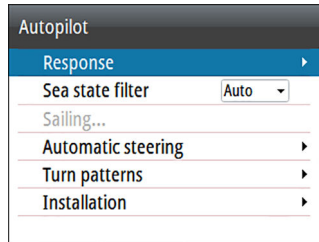

Response (AC12N/AC42N)

The AC12N/42N includes three different sets of steering modes; High (HI), Low (LO) and Wind. The mode can be automatically or manually selected.

The speed at which the autopilot automatically changes from LO to HI parameters (or opposite) is determined by the Transition speed setting, defined during the commissioning of the autopilot. Refer to the detailed description in the autopilot computer's documentation.

You can manually fine tune each of the three response modes. Level 4 is default with parameter values as set by the autotune function. If no autotune is made (not recommended) the level 4 values are the factory default values.

- A low response level reduces the rudder activity and provides a more "loose" steering
- A high response level increases the rudder activity and provides a more "tight" steering. A too high response level causes the boat to start s movements.

The Wind response is used on sailboats

- Increase the Wind value if the difference between the set wind angle and the actual wind angle is too big
- Decrease the Wind value if the actual wind angle is S-ing around the set wind angle, or if the rudder activity is too high

The performance mode is indicated in the top left corner of the autopilot page.

- HI-A: High response mode set automatically

- LO-A: Low response mode set automatically
- HI-M: High response mode set manually
- LO-M: Low response mode set manually

➔ **Note:** If no speed input is available the autopilot defaults to LO steering parameters when engaging an automatic mode. This is a safety feature to prevent oversteering

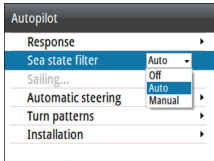

Sea state filter (AC12N/AC42N)

This filter is used to reduce rudder activity and autopilot sensitivity in rough weather.

- OFF: Sea state filter is disabled. This is the default setting.
- AUTO: Reduces rudder activity and autopilot sensitivity in rough weather by an adaptive process. The AUTO setting is recommended if you want to use the sea state filter.
- MANUAL: Linked to the steering response control settings described previously. It may be used to manually find the optimum combination of course keeping and low rudder activity in rough but steady sea conditions.

Sailing (AC12N/AC42N)

➔ **Note:** Sailing parameters are only available when the boat type is set to Sail.

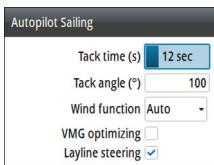

- Tack time: Controls the rate of turn (tack time) when performing a tack in wind mode.
- Tack angle: Controls the angle that the boat will tack to between 50° - 150° in AUTO mode
- Wind mode: Select what wind function the autopilot will use when in wind mode
 - Auto:
 - If AWA is $\leq 60^\circ$: Wind mode will use AWA
 - If AWA is $> 60^\circ$: Wind mode will use TWA
 - Apparent
 - True
- VMG optimizing: Optimize the VMG to wind. The function will be active for 5–10 minutes after a new wind angle has been set and only when beating.

- Layline steering: When enabled the Cross Track Error (XTE) from the navigator will keep the boat on the track line. If the XTE from the navigator exceeds 0.15 Nm, the autopilot will calculate the layline and track towards the waypoint.

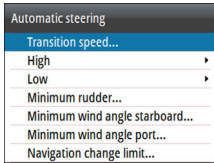

Automatic steering (AC12N/AC42N)

This option allows for manually changing parameters that were set during the commissioning of the autopilot computer. For more details of the settings, refer to the separate documentation for the autopilot computer.

- Transition speed: This is the speed at which the autopilot will automatically change the steering parameter set from HI to LO parameters, or vice versa. On power boats it is recommended to set the Transition speed to a speed that represents the speed where the hull begins to plane or the speed where you change from slow to cruising speed
On sailboats the Transition speed should be set to 3-4 knots to give the best response in a tack
- High/Low
 - Rudder gain: This parameter determines the ratio between commanded rudder and the heading error. The higher rudder value the more rudder is applied. If the value is too small it will take a long time to compensate for a heading error, and the autopilot will fail to keep a steady course. If the value is set too high the overshoot will increase and the steering will be unstable.
 - Counter rudder: Relation between change in heading error and applied rudder. Higher counter rudder will reduce applied rudder faster when approaching the set heading
 - Auto trim: Controls how aggressively the autopilot will apply rudder to compensate for a constant heading offset, e.g. when external forces such as wind or current affects the heading. Lower autotrim will give faster elimination of a constant heading offset
 - Rate limit: The rate the vessel is turning in degrees per minute
- Minimum rudder: Some boats may have a tendency of not responding to small rudder commands around the course keeping position because of a small rudder, a rudder deadband,

whirls/disturbance of the water-stream passing the rudder or it is a single nozzle water jet boat. By manually adjusting the minimum rudder function, the course keeping performance might be improved on some boats. This will however increase the rudder activity.

- Min wind angle starboard / Min wind angle port: This is the minimum apparent wind angle that will keep the sails well shaped and give an acceptable thrust. This parameter will vary from boat to boat. The setting applies for the tack-prevent function. It also applies when the autopilot is operating in WindNAV mode. You can select different minimum wind angles for port and starboard. The difference between port and starboard will be taken into account when calculating the Distance To Turn (DTT).
- Navigation change limit: Defines the limits for course change to next waypoint in a route. If the course change is more than this set limit, you are prompted to verify that the upcoming course change is acceptable

SG05 Autopilot computer

The SG05 Autopilot computer offers the same settings as the AC12N/AC42N Autopilot computers. Refer to "*AC12N/AC42N Autopilot computer*" on page 39.

System settings

Network

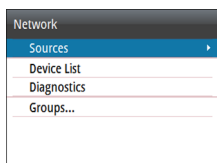

Sources

Data sources provide live data to the system.

The data may originate from modules internal to the unit (for example internal GPS or sonar), or external modules connected to the NMEA 2000 or via NMEA 0183 if available on the unit.

When a device is connected to more than one source providing the same data, the user can choose the preferred source. Before commencing with source selection make sure all external devices and the NMEA 2000 backbone are connected and are turned on.

- Auto select: Looks for all sources connected to the device. If more than one source is available for each data type, selection is made from an internal priority list. This option is suitable for the majority of installations.
- Manual source selection: Manual selection is generally only required where there is more than one source for the same data, and the automatically selected source is not the one desired.

Device list

The Device list shows the devices that provide data. This may include a module inside the unit, or any external NMEA 2000 device.

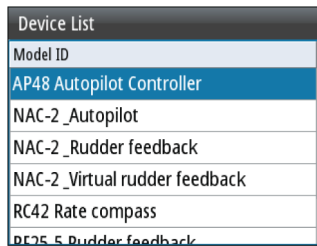

| Model ID |
|-------------------------------|
| AP48 Autopilot Controller |
| NAC-2_Autopilot |
| NAC-2_Rudder feedback |
| NAC-2_Virtual rudder feedback |
| RC42 Rate compass |
| RC75_5 Rudder feedback |

Selecting a device in this list will bring up additional details and actions:

All devices allow allocation of an instance number in the **Configure** option. Set unique instance numbers on any identical devices on the network to allow for the unit to distinguish between them. The **Data** option shows all data being output by the device.

Some devices will show additional options specific to the device.

→ **Note:** Setting the instance number on a 3rd party product is typically not possible.

Diagnostics

The NMEA 2000 tab on the diagnostics page can provide information useful for identifying an issue with the network.

→ **Note:** The following information may not always indicate an issue that can be simply resolved with minor adjustment to network layout or connected devices and their activity on the

network. However, Rx and Tx errors are most likely indicating issues with the physical network, which may be resolved by correcting termination, reducing backbone or drop lengths, or reducing the number of network nodes (devices).

Bus state

Simply indicates whether the bus is powered, but not necessarily connected to any data sources. However, if bus shows as **off**, but power is present along with an increasing error count, it is possible that termination or cable topology is incorrect.

Rx Overflows

The unit received too many messages for its buffer before the application could read them.

Rx Overruns

The unit contained too many messages for its buffer before the driver could read them.

Rx/Tx Errors

These two numbers increase when there are error messages, and decrease when messages are received successfully. These (unlike the other values) are not a cumulative count. Under normal operation these should be at 0. Values around 96 upwards indicate a heavily error prone network. If these numbers go too high for a given device, it will automatically drop off the bus.

Rx/Tx Messages

Shows actual traffic in and out of device.

Bus Load

A high value here indicates network is near full capacity. Some devices automatically adjust rate of transmission, if network traffic is heavy.

Fast Packet Errors

Cumulative counter of any fast packet error. This could be a missed frame, or a frame out of sequence etc. NMEA 2000 PGNs are made of up to 32 frames. The entire message will be discarded when a frame is missed.

→ **Note:** Rx and Tx Errors often indicate an issue with the physical network, which may be resolved by correcting termination, reducing backbone or drop lengths, or reducing the number of network nodes (devices).

Network groups

The Network Group function is used to control parameter settings, either globally or in groups of units. The function is used on larger vessels where several units are connected to the network. By assigning several units to the same group, a parameter update on one unit will have the same effect on the rest of the group members.

Units

Provides setup of units of measure used on various data types.

Decimal places

Defines number of decimals used for speed and sea temperature.

Key beeps

Controls the loudness of the beep sound when a key is pressed.

Default setting: Loud

Language

Controls the language used on this unit for panels, menus, and dialogs. Changing the language causes the unit to restart.

Time

Controls the local time zone offset, and the format of the time and date.

Display setup

Displays the Display setup dialog.

The following options are available:

- Backlight level: Adjusts the backlight level from Min (10%) to Max (100%) in 10% increments
 - When the Backlight level field is active, subsequent presses on the power key adjusts backlight level in decrements of 30%

- Display group: Defines which network group the unit belongs to
- Night mode: Activates/deactivates the night mode color palette
- Night mode color: Sets the night mode color palette
- Invert day color: Changes the background color for the pages from default black to white
- Sleep: Turns the backlight for screen and keys off to save power

Digital gauges

Controls whether to display one or two gauges in the panel.

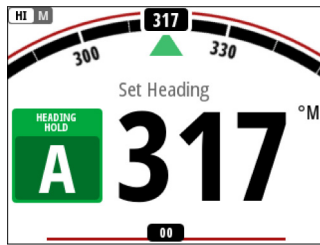

One gauge

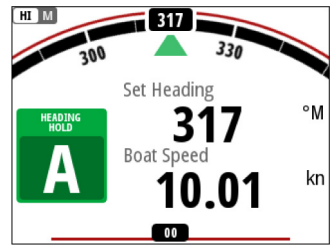

Two gauges

Files

File management system. Used to browse the contents of the unit's internal memory and the content of a device plugged into the unit's USB port.



Simulate

Runs the display with simulated data. Use the simulator to become familiar with your unit before using it on the water.

When activated, the simulator mode is indicated on the display.

Restore defaults

Allows you to select which settings are to be restored to their original factory settings.

Global reset

Resets the source selection on all displays connected to the network.

About

Displays copyright information, software version, and technical information for this unit.

7

Maintenance

Preventive maintenance

The unit does not contain any field serviceable components. Therefore, the operator is required to perform only a very limited amount of preventative maintenance.

It is recommended that you always fit the supplied protective sun cover when the unit is not in use.

Cleaning the display unit

A proper cleaning cloth should be used to clean the screen, where possible. Use plenty of water to dissolve and take away salt remains. Crystallized salt may scratch the coating if using a damp cloth. Apply minimal pressure to the screen.

Where marks on the screen cannot be removed by the cloth alone, use a 50/50 mixture of warm water and isopropyl alcohol to clean the screen. Avoid any contact with solvents (acetone, mineral turpentine, etc.), or ammonia based cleaning products, as they may damage the anti-glare layer or plastic bezel.

To prevent UV damage to the plastic bezel, it is recommended that the sun cover be fitted when the unit is not in use for an extended period.

Checking the connectors

The connectors should be checked by visual inspection only.

Push the connector plugs into the connector. If the connector plugs are equipped with a lock, ensure that it is in the correct position.

Backup and restore of system data

The system includes a backup and restore function, making it possible to back-up and restore system settings and autopilot configuration files.

→ **Note:** It is strongly recommended to make a backup when the system is installed and configured.

Backup and restore is initiated from the **Files** option when a memory stick is inserted in the USB port on the back of the unit.

The unit will automatically select import or export option depending on the file type selected.

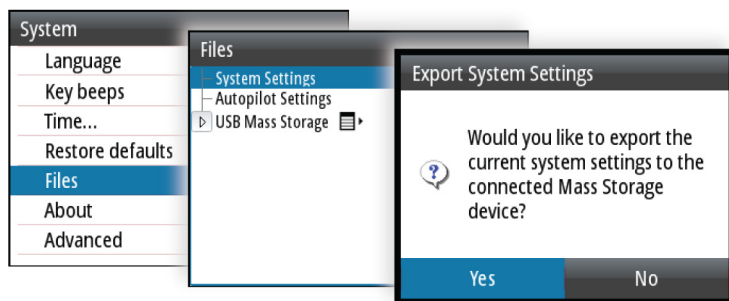

Software update

The AP48 includes a USB port of the back of the units. You use this port for software updates.

You can update the software for the unit itself and for NMEA 2000 sensors connected to the network from the AP48.

You can check the units software version from the About dialog. The software version for connected NMEA 2000 sensors is available in the Device list.

The latest software is available for download from our website: www.simrad-yachting.com.

1. Download the latest software from our website: www.simrad-yachting.com, and save it to a USB device
2. Insert the USB device to the AP48 unit
3. Start the File explorer, and select the update file on the USB device
4. Start the update from the file details dialog
5. Remove the USB device when the update is completed

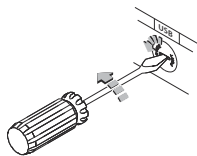

8

Menu tree

The system includes a Settings menu, accessed by pressing the **MENU** key. The Settings menu gives access to settings for the sensors, the vessel, the autopilot computer and for the system.

| Level 1 | Level 2 |
|--------------------|-------------------|
| Calibration | Boat speed... |
| | Wind... |
| | Depth... |
| | Heading... |
| | Roll/Pitch... |
| | Environment... |
| | Rudder... |
| | Advanced... |
| Damping | Heading |
| | Apparent wind |
| | True wind |
| | Boat speed |
| | SOG |
| | COG |
| | Attitude Roll |
| | Attitude Pitch |
| Trip log | Tide |
| | Trip 1... |
| | Trip 2... |
| Alarms | Log... |
| | Alarm history... |
| | Alarm settings... |
| | Alarms enabled |
| | Siren Enabled |

| Level 1 | Level 2 |
|--|---------------------|
| Autopilot, NAC-2 and NAC-3 * Refer to the NAC-2/NAC-3 Commissioning manual | Steering |
| | Sailing |
| | Turn patterns |
| | Installation * |
| Autopilot, AC12N, AC42N and SG05 ** Refer to the AC12N/AC42N Installation manual | Response |
| | Sea state filter |
| | Sailing |
| | Automatic steering |
| | Turn patterns |
| | Installation ** |
| System | Network |
| | Units |
| | Decimal places |
| | Key beeps |
| | Language |
| | Time |
| | Display Setup... |
| | Digital gauges |
| | Files |
| | Simulate |
| | Restore defaults... |
| | Global reset... |
| | About |

9

Technical specifications

| | |
|---------------------------------------|--|
| Approvals | Refer to " <i>Compliance statements</i> " on page 4 |
| Dimensions | Refer to " <i>Dimensional drawings</i> " on page 54 |
| Weight (without accessories) | 0.51 kg (1.13 lbs) |
| Power | |
| Supply voltage | 12 V (10.8V < supply voltage < 15.6V) |
| Supply connection | Micro-C (CAN) |
| Backlight OFF | 1.62 W (0.12 A @13.5 V) |
| Backlight MAX | 2.97 W (0.22 A @13.5 V) |
| Network load | 5 LEN (244 mA max) |
| Color | Black |
| Display | |
| Size | 4.1" (diagonal). 4:3 Aspect ratio |
| Type | Transmissive TFT-LCD |
| Resolution | 320 x 240 pixels |
| Viewing angles | 80° top/bottom, 80° left/right |
| Brightness | > 600 nits |
| Color scheme | White or black for day mode. Red, green, blue or white for night mode |
| Multiple controller support | Yes |
| Compatible autopilot computers | AC12, AC42, SG05, NAC-2, NAC-3 |
| Mounting options | Dashboard, bracket (sold separately) |
| SW upgrade method | USB |
| Alarm sound pressure level | 75 dB |
| Environmental protection | |
| Waterproof rating | IPx7 |

| | |
|--------------------|-----------------------------------|
| Humidity | 100% RH |
| Temperature | |
| Operating | -25°C to +65°C (-13°F to +149°F) |
| Storage | -40°C to +85°C (-104°F to +185°F) |

10

Dimensional drawings

AP48 without bracket

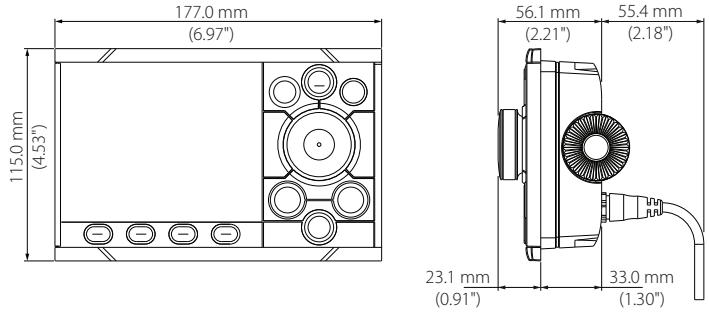

AP48 with bracket

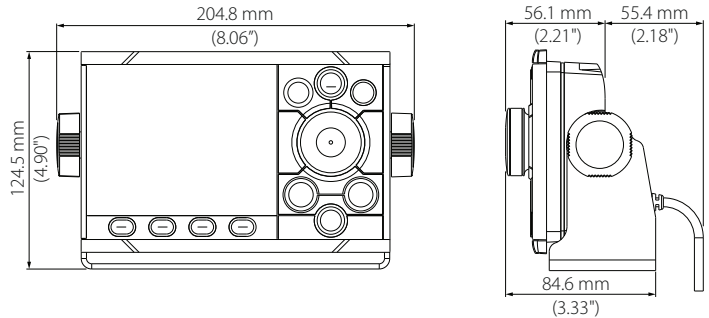

11

Supported data

NMEA 2000 PGN (transmit)

| | |
|--------|----------------------------|
| 59904 | ISO Request |
| 60928 | ISO Address Claim |
| 126208 | ISO Command Group Function |
| 126996 | Product Info |
| 127258 | Magnetic Variation |

NMEA 2000 PGN (receive)

| | |
|--------|----------------------------|
| 59392 | ISO Acknowledgement |
| 59904 | ISO Request |
| 60928 | ISO Address Claim |
| 126208 | ISO Command Group Function |
| 126992 | System Time |
| 126996 | Product Info |
| 127237 | Heading/Track Control |
| 127245 | Rudder |
| 127250 | Vessel Heading |
| 127251 | Rate of Turn |
| 127257 | Attitude |
| 127258 | Magnetic Variation |
| 128259 | Speed, Water referenced |
| 128267 | Water Depth |
| 128275 | Distance Log |
| 129025 | Position, Rapid Update |
| 129026 | COG & SOG, Rapid Update |
| 129029 | GNSS Position Data |
| 129033 | Time & Date |

| | |
|--------|---|
| 129283 | Cross Track Error |
| 129284 | Navigation Data |
| 129539 | GNSS DOPs |
| 129283 | Cross Track Error |
| 129284 | Navigation Data |
| 130074 | Route and WP Service - WP List - WP Name & Position |
| 130306 | Wind Data |
| 130576 | Small Craft Status |
| 130577 | Direction Data |

12

Appendixes

List of possible alarms and corrective actions

List of possible alarms and corrective actions

Autopilot alarms

| Alarm/Warning | Possible cause | Recommended action |
|-----------------------|--|---|
| AP clutch disengaged | Poor connection or open circuit in bypass/clutch coil. | <ul style="list-style-type: none">• Check cables and connections• Replace bypass/Clutch if open• Perform new rudder test |
| AP clutch overload | Clutch current exceeds limit. | <ul style="list-style-type: none">• Check actual current• Check voltage marking on coil• Check coil resistance (including resistance in connected wires)• Check cables and connections |
| AP depth data missing | Missing or invalid depth data. | <ul style="list-style-type: none">• Check device list for valid depth source• Try a new automatic source selection• Check cables and connections |
| AP low boat speed | Boat speed below set limit. Poor rudder response can be experienced at lower speeds. | <ul style="list-style-type: none">• Manually control the vessel• Increase vessel speed |
| AP speed data missing | The speed signal from the GPS or the log is missing. | <ul style="list-style-type: none">• Check device list for valid speed source• Try a new automatic source selection• Check cables and connections |

| Alarm/Warning | Possible cause | Recommended action |
|--------------------------|---|--|
| AP heading data missing | No data from selected compass. | <ul style="list-style-type: none"> • Select a different compass source • Make a source update • Check cables and connections |
| AP Nav data missing | Navigation data from Plotter/ECS missing. | <ul style="list-style-type: none"> • Check that route is activated on Plotter/MFD • Check device list for valid navigation source • Try a new automatic source update • Check cables and connections |
| AP off course | Vessel heading is outside the set off course limit. May be caused by extreme weather conditions, and/or too slow speed. | <ul style="list-style-type: none"> • Increase boat speed, if possible, or steer by hand • Check steering parameters (Rudder, Autotrim, Seastate filter) • Increase response/rudder value |
| AP position data missing | Position data from the GPS is missing. | <ul style="list-style-type: none"> • Check that the GPS antenna has a clear view of the sky • Check device list for valid position source • Try a new automatic source update • Check cables and connections |
| AP rudder data missing | Rudder angle signal to autopilot computer is missing. | <ul style="list-style-type: none"> • Check the source selection and that the autopilot computer commissioning has been completed • Check cables and connections • If missing sensor is a CAN device, check network connection |
| AP wind data missing | Missing or invalid wind data. | <ul style="list-style-type: none"> • Check cables and connections |

| Alarm/Warning | Possible cause | Recommended action |
|------------------------|--|---|
| CAN bus failure | Not possible to send or receive data although bus voltage is ok. | <ul style="list-style-type: none"> • Check cable connections |
| Check heading | Jump in heading of more than 10°/second. | <ul style="list-style-type: none"> • Check steering compass • Change to another heading source |
| Drive inhibit | Motor or solenoid drive electronics critically overloaded. | <ul style="list-style-type: none"> • Check connectors and cables • Check that the rudder angle measurement and the actual physical rudder position corresponds • Try to hand steer the rudder and verify that the rudder can be moved freely |
| Drive not available | Autopilot system is unable to control the rudder. | <ul style="list-style-type: none"> • No rudder response often accompanied by drive not available |
| Drive unit failure | The autopilot computer has lost communication with device. | <ul style="list-style-type: none"> • Check connectors and cables |
| End of route | Shown on the active control unit when an end route waypoint name has been received from the Plotter/ECS. | <ul style="list-style-type: none"> • Manually control the vessel • Select a new rout |
| Engage output overload | Bypass valve or clutch is drawing excessive current. | <ul style="list-style-type: none"> • Ensure there is no shortage to ground or cabling damage • Disconnect cable from autopilot computer to motor, and make sure there is no alarm when engaging FU or AUTO mode |

| Alarm/Warning | Possible cause | Recommended action |
|----------------------------------|--|---|
| EVC Com error | Lost communication with EVC system (Volvo IPS and similar). | <ul style="list-style-type: none"> • Check connection with EVC engine interface. For IPS, engine must be running |
| EVC Override | EVC override via SG05. | <ul style="list-style-type: none"> • If unintended warning, make sure override handle is not being activated by loose objects |
| High drive supply | Supply voltage exceeds 35 V. | <ul style="list-style-type: none"> • Check battery/charger condition |
| High drive temp | Drive electronic temperature exceeds the set limit. | <ul style="list-style-type: none"> • Switch off autopilot and let the drive unit cool down • Check for overload in drive unit/steering system • Check that the autopilot computer specifications matches the drive unit • Check that the drive unit is appropriately dimensioned for the boat and rudder size |
| High temperature | Excessive temperature in autopilot computer (>80° C), possible long term overload. | <ul style="list-style-type: none"> • Switch off autopilot • Check for overload in drive unit/steering system • Check that the autopilot computer specifications matches drive unit |
| Low drive supply | Low supply voltage. | <ul style="list-style-type: none"> • Check battery/charger condition • Verify mains cable has correct gauge |
| No active autopilot control unit | Autopilot computer has lost contact with active control unit. | <ul style="list-style-type: none"> • Was active controller switched off/put to sleep? • Take command with a different controller/remote • Check connectors and cables • Replace the control unit |

| Alarm/Warning | Possible cause | Recommended action |
|-----------------------|---|--|
| No autopilot computer | Active control unit has lost contact with autopilot computer. | <ul style="list-style-type: none"> • Check the network diagnostics page on the display unit. Should show few or no errors • Check that the NMEA 2000 network is powered and terminated according to guidelines • Check that source selection is made and that the correct autopilot computer is selected • Check connectors and cables • Check status LED on autopilot computer. Should blink steadily, 1 sec intervals • Replace autopilot computer |
| No rudder response | No response to rudder command. | <ul style="list-style-type: none"> • Check connectors and cables • Check rudder feedback transmission link (not applicable for Virtual feedback installations) • Check the drive unit motor/brushes • Check for mechanical play in rudder • Check if the rudder is actually not moving • Check that the rudder drive unit is powered and running • Check for other mechanical issues between autopilot computer and rudder |

| Alarm/Warning | Possible cause | Recommended action |
|-----------------------|---|--|
| Rudder drive overload | <p>Reversible motor: motor stalls or is overloaded.</p> <p>Solenoids: shortage to ground or cabling damage.</p> | <ul style="list-style-type: none"> • Check for possible mechanical blocking of rudder • If heavy sea at high rudder angle, try to reduce boat speed or rudder angle by steering at another heading • Make sure there is no shortage to ground or cabling damage • Disconnect cable from autopilot computer to motor, and make sure there is no alarm when trying to run in NFU mode • Check that the drive unit is appropriately dimensioned for the boat and rudder size |
| Rudder limit | <p>The set rudder limit has been reached or exceeded. May be caused by disturbance to compass (waves), speed log, sharp turn or improper parameter setting.</p> | <ul style="list-style-type: none"> • Notification only |
| True wind shift | <p>True wind shift exceeds wind shift limit.</p> | <ul style="list-style-type: none"> • Take appropriate action to handle the vessel • Re-enter WIND mode to reset the Wind shift reading |
| Wind shift | <p>True wind direction has changed by more than the limit.</p> | <ul style="list-style-type: none"> • Take appropriate action to handle the vessel • Re-enter WIND mode to reset the Wind shift reading |

System alarms

| Alarm/Warning | Possible cause | Recommended action |
|-------------------------|--|--|
| Anchor | Anchor drift alarm, vessel movement exceeds the set limit. | <ul style="list-style-type: none">• Take appropriate action to handle the vessel• Reposition the anchor |
| Anchor depth | Anchor depth below set limit. | <ul style="list-style-type: none">• Take appropriate action to handle the vessel• Reposition the anchor |
| CAN bus supply overload | Current > 10A. | <ul style="list-style-type: none">• Check summary unit loads• Excessive current draw• Check for short circuit/defective device on network |
| Deep water | Depth exceeds the set limit. | <ul style="list-style-type: none">• Take appropriate action to handle the vessel• Navigate to shallower waters |
| Low boat speed | Boat speed below set limit. | <ul style="list-style-type: none">• Increase boat speed |
| Low CAN bus voltage | CAN bus voltage < 10V. | <ul style="list-style-type: none">• Check battery/charger condition• Check cable length, bus load and bus supply feeding point• If possible, check if fault disappears by disconnecting some units |
| No GPS fix | GPS lost contact with satellites. | <ul style="list-style-type: none">• Check that the GPS antenna has a clear view of the sky |
| Shallow water | Depth below set limit. | <ul style="list-style-type: none">• Navigate to deeper waters• Proceed with caution• Check charts |
| True wind high | True wind speed above set limit. | <ul style="list-style-type: none">• Take appropriate action to secure boat, sails and crew |

| Alarm/Warning | Possible cause | Recommended action |
|---------------|---|---|
| True wind low | True wind speed below set limit. | <ul style="list-style-type: none">• Notification only |
| XTE | Cross Track Error, distance between the current position and a planned route exceeds the set limit. | <ul style="list-style-type: none">• Manually control the vessel• Select a new route• Check navigation and charts. Navigation is outside of planned corridor |



SIMRAD

