



SIDE-POWER
Thruster Systems

Keep this
manual onboard!

Control Panels **PJC 211 & PJC 212**



To download your language go to www.side-power.com



SLEIPNER MOTOR AS

P.O. Box 519
N-1612 Fredrikstad
Norway
www.side-power.com

Document id: 2917

Revision: I2

Date: 2020



Made in Norway

© Sleipner Motor AS 2020

Considerations and Precautions	3
Installation Manual	
Panel Layout & Functions	4
Technical Specifications & Measurements	5
Connections	6
Setup Procedure	7
Menu System Setup	7
System Devices	7
Control Panel Setup Buttons	8
Combining Stabilizer with AC & DC Thrusters	8
AC System - PDC 101 Setup	8
AC System - PDC 201 Setup	8
AC System - PDC 301 Setup	9
DC System - Automatic Main Switch Setup	10
DC System - PPC, SR150000, SR61242 Setup	10
DC System - RCRS 1 & RCRS 2 Setup	11
DC System - MSI8730 Setup	11
DC System - ESI 1 & GW 1 Setup	11
Hold Calibration	12
Joystick Calibration	12
Menu System Information	12
Information - PPC, SR150000, SR61242	12
Information - PDC101 & PDC201	13
Information - PDC301	13
Panel Information	13
S-Link Diagnostic	13
Menu System - Panel Setup	14
Alarm System	15
SAC Power Management Status	15
User Manual	
Proportional Thruster Display	16
Proportional Thruster Display Symbols	17
HOLD Function	18
Calibration	18
Warning Signals When Using 'HOLD' Function	18
MENU System	19
Alarm Descriptions	20 - 21
PHC-3 Alarm Descriptions	22 - 23
PDC-301 Alarm Descriptions	23
Notes	24 - 26
Product Information	
Note Type, Location and Serial Numbers	27

DECLARATION OF CONFORMITY

MC_0020



Sleipner Motor AS
P.O. Box 519, Arne Svendsensgt. 6-8
N-1612 Fredrikstad, Norway

Declare that this product with accompanying standard control systems complies with the essential health and safety requirements according to:

DIRECTIVE 2013/53/EU
DIRECTIVE 2014/30/EU
DIRECTIVE 2014/35/EU

It is the installers responsibility

When installing Side-Power equipment to follow the outlined regulations/ classification rules (electrical/ mechanical) according to international or special national regulations. Instructions in this guide cannot be guaranteed to comply with global electric/ mechanic regulations/ classification rules.

To follow all health and safety laws in accordance with their local outlined regulations/ classification rules.

Before installation, it is important that the installer reads this guide to ensure necessary acquaintance with this product.

The recommendations made in this manual are guidelines ONLY, and Sleipner Motor AS (Side-Power) strongly recommend that before installation, advice is obtained from a naval architect familiar with the particular vessel and regulations/ classifications.

This manual is intended to support educated/ experienced staff and is therefore not sufficient in all details for professional installation. *(NB: These instructions are only general instruction. If you are not skilled to do this work, please contact professional installers for assistance.)*

All electrical work must be done by a licensed professional.

Faulty installation of the tunnel, thruster or panel will render all warranty given by Sleipner Motor AS void.

MC_0038

EN

Considerations and Precautions

MC_0105

IMPORTANT

If installing S-link products DO NOT connect any other control equipment to the S-link controlled products except Side-Power original S-link products or via a Side-Power supplied interface product made for interfacing with other controls. Any attempt to directly control or at all connect into the S-link control system without the designated and approved interface will render all warranties and responsibilities for the complete line of Side-Power products connected void and null. If you are interfacing by agreement with Sleipner and through a designated Side-Power supplied interface, you are still required to also install at least one original Side-Power control panel to enable efficient troubleshooting if necessary.

PJC-211

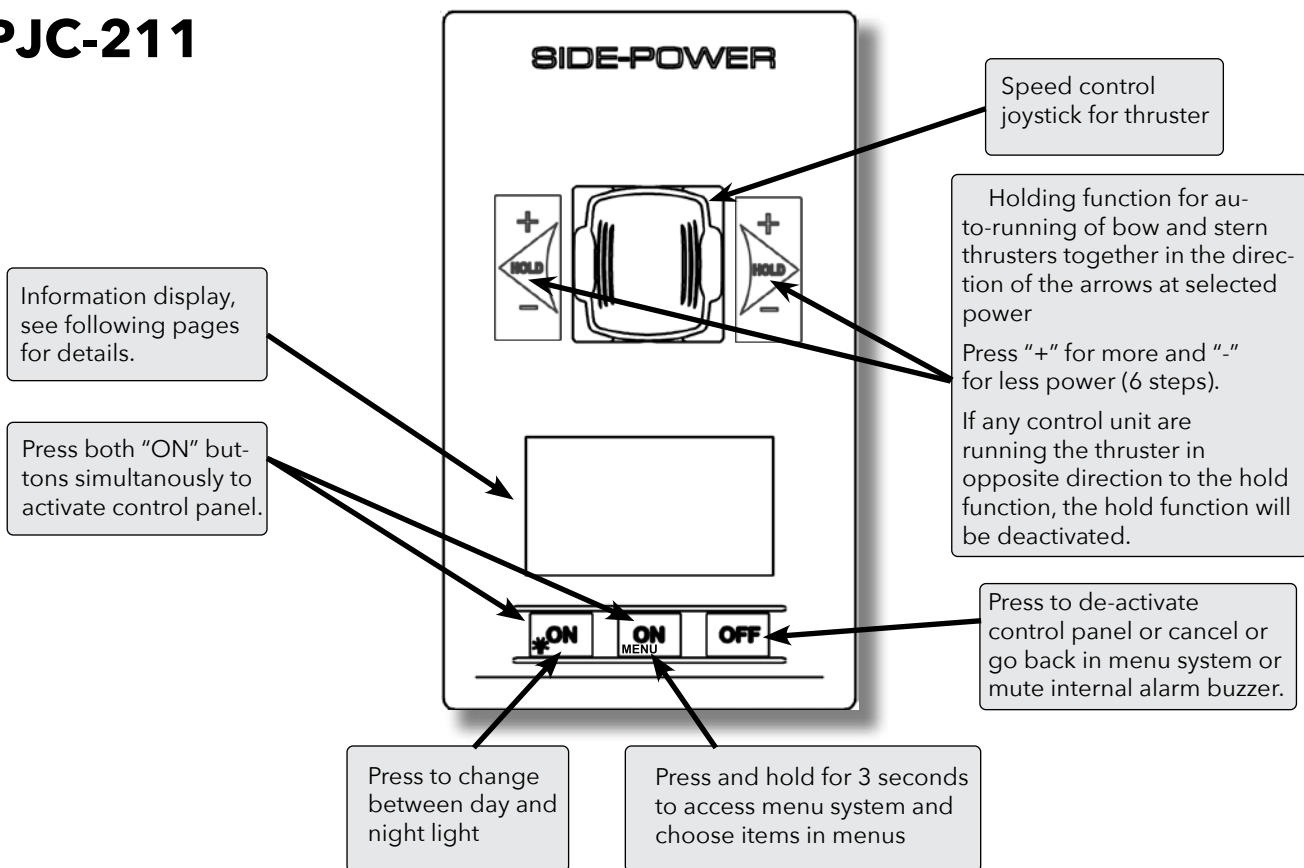

PJC-212

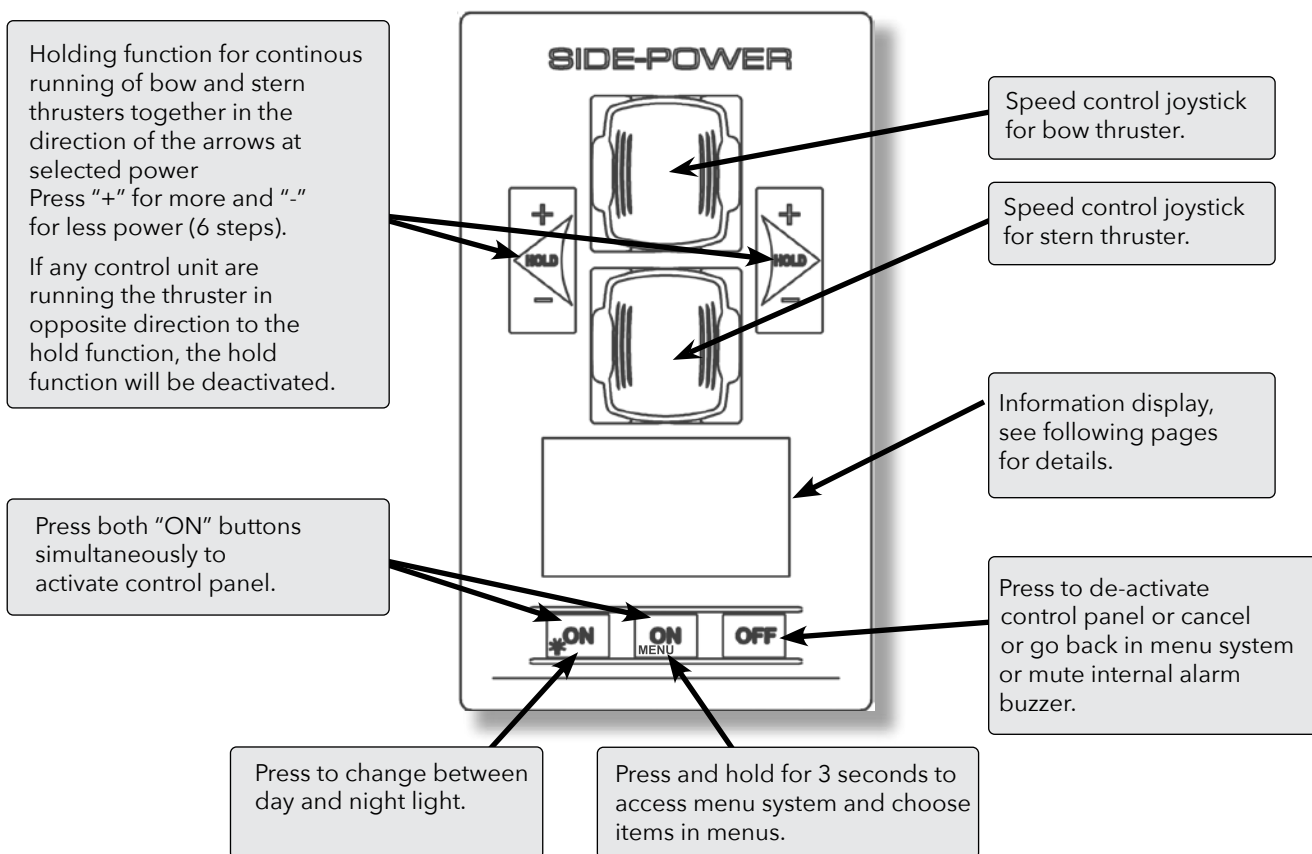

Description	Minimum	Maximum	Units	Comment
Input voltage	9	31	Volt DC	Powered from S-Link
Current Voltage	20	120	mA	
External Alarm Buzzer Voltage		31	Volt DC	
External Alarm Buzzer Current		500	mA	Internally fused

Description	Value
Operating temperature	-10 to + 60 degrees C.
Storage temperature	-20 to + 70 degrees C.
IP rating front	IPx6
IP rating back	IPx4
Humidity	max 95% RH
EMC tested	Acc. to EN 60533
Weight	215 gr.

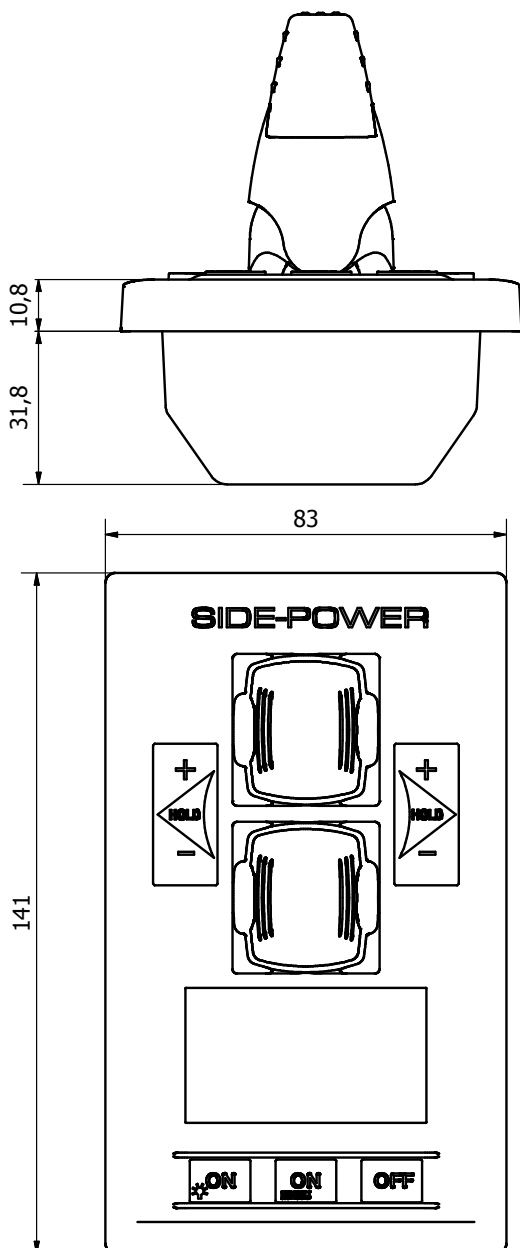

This illustration is for measurements use only. Use external template when mounting.

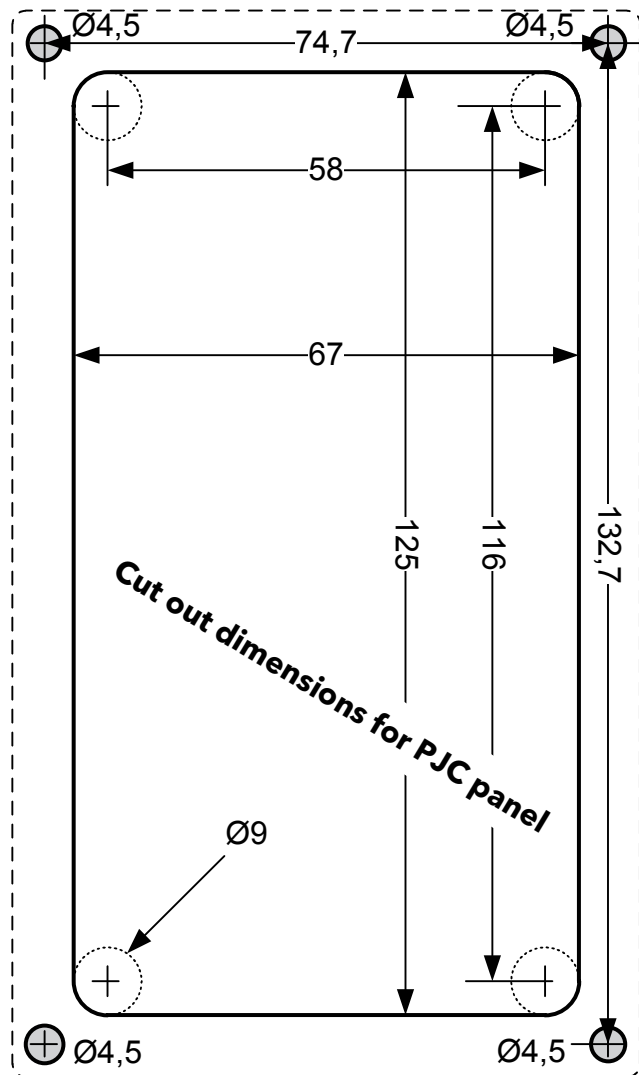

Connections for optional external buzzer/audible alarm.

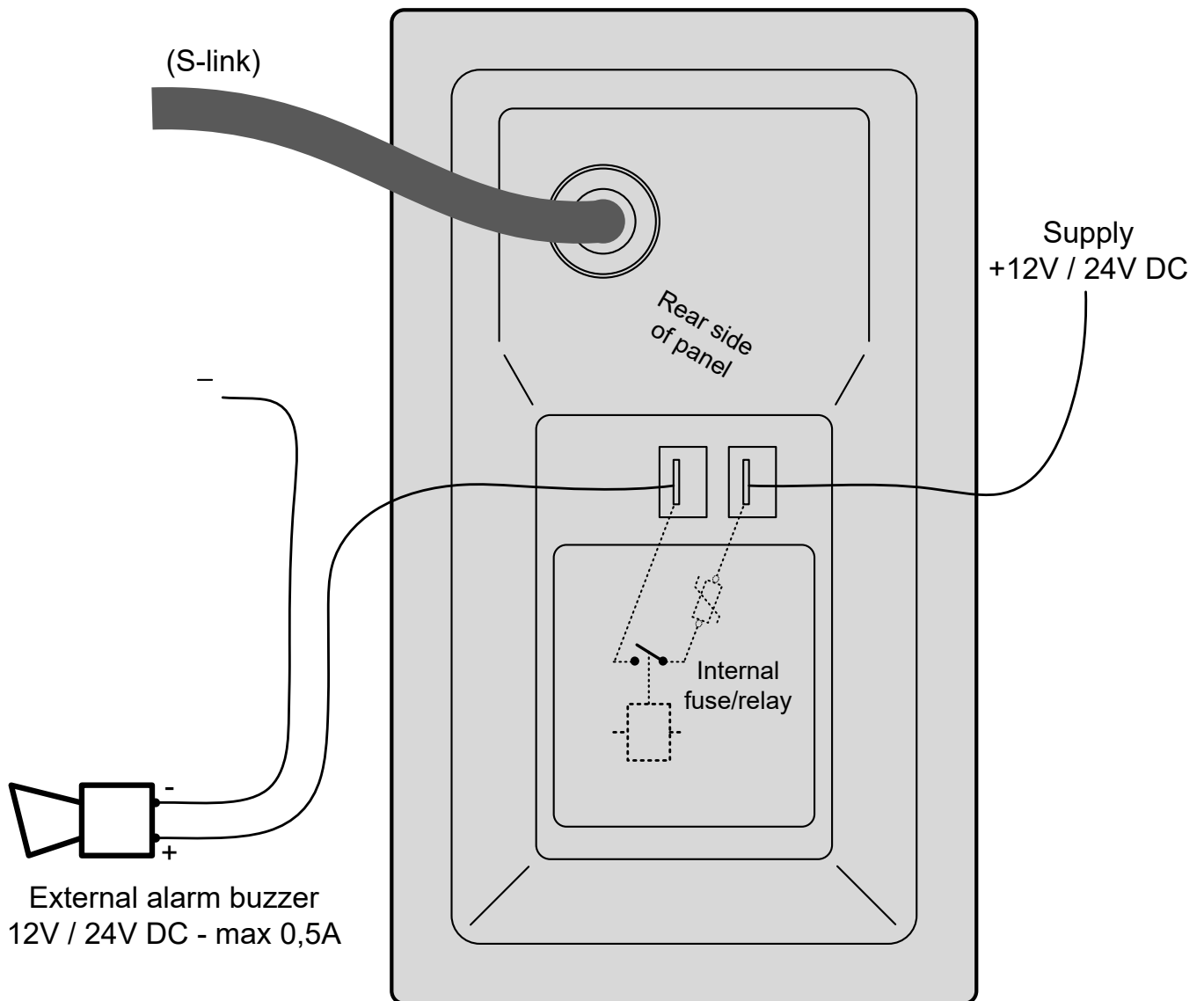

At the first startup of a new system, one of the two screens below will be shown:

1.0 SETUP DO NOT MATCH SYSTEM.

✓ FOR AUTO SETUP

New devices found. Not in conflict with other devices.
Press button below the -symbol to auto setup.

Thrusters can not be operated to auto setup is completed.

'OR'

2.0 RUN SETUP! DEVICES IN CONFLICT!

Detected devices in conflict. Two or more thrusters defined as same instance (bow/stern/bow STB/Stern STB). Run Setup procedure to correct.

Thrusters cannot be operated until setup is completed.



The setup procedure requires knowledge of the serial number and location of all the S-link devices.

Write this down in the form on the last page to have the information at hand when doing a manual setup.

2.1 Press and hold the button marked "MENU" for 3 seconds to enter the menu system. Use the (stern) joystick to select "SETUP", Press button below the -symbol to enter the "SETUP"-menu.



2.2 Use the (stern) joystick to select "SYSTEM DEVICES", Press button below the -symbol to enter the "SYSTEM DEVICES"-menu.



2.3 Use the (stern) joystick to set the pin code one number at the time, press button below the -symbol to jump to next number and confirm. The pin code is "9 9 9 9".



(NB: Re-entering the SYSTEM DEVICES menu within 15 minutes does not require entering PIN code.)



2.4 For about 2 seconds an hourglass will appear while scanning the S-link for devices. The devices found in the system is now displayed with their instance (thruster type and location) and serial number.



Go through all devices and make sure that they are set to the correct instance and function (refer to detailed instructions in the SETUP section of "Menu System"-chapter).

Press button below the -symbol to save setting and return to "Setup"- Menu.

SETUP

Move between menu items with the (stern) joystick.
Press the button below  to select the highlighted menu entry.
Press the button below  to return to the previous menu.

Setting done under SETUP will be sent to all other panels in the system.



Setup

Default in systems without stabilizers

SYSTEM DEVICES

View all devices connected to S-Link and manually change setup values.

A PIN code is required to enter the SYSTEM DEVICES menu. Use the (stern) joystick to set the pin code one number at a time, press button below the -symbol to jump to next number and confirm. The pin code is "9 9 9 9".

The number of devices found is shown in the upper right corner of the display. Use (stern) joystick to move between the installed devices.



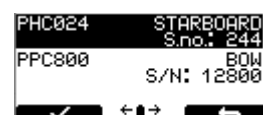

The list of devices found can fill more than one screen. A scroll bar indicates the position of the selected item.

(NB: Re-entering the SYSTEM DEVICES menu within 15 minutes does not require re-entering PIN code.)





Default in systems without stabilizers

Press the button below  to return to the previous menu.
 Press the button below  to edit the selected parameter.
 Parameter value will start to blink, use joystick to alter value.
 Press the button below  to save edited parameter to device.
 Press the button below  to cancel editing without saving.

Combining Stabilizer with AC & DC Thrusters

SETUP

NOTICE regarding following Location modes: If the boat has Side-Power stabilizer and AC or DC thrusters the thruster location should be set as BOW-STB or STERN-STB. This so the hydraulic controller are shown at the left side in display and thruster(s) at the right side of the display.

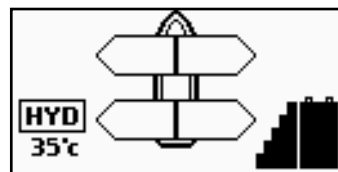

HYD-DC

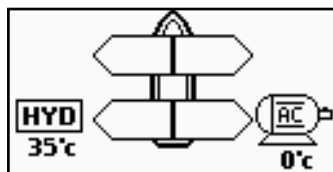

HYD-AC

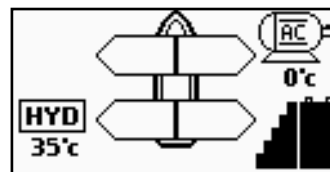

HYD-AC-DC



Default in systems without stabilizers

AC System - PDC 101 Setup

3.0 PDC 101

(SAC Controller) (This device is not able to edit. Pre-setup from factory.)

PDC101 must be setup by authorized personnel.
 Firmware version and serial number is Not Available (NA).

3.1 Location

Values: BOW/STERN/BOW-STB/STERN-STB
 BOW or STERN in a conventional thruster system.
 In a system with two bow or stern thrusters (i.e a catamaran), BOW and STERN is port thruster, BOW-STB and STERN-STB is starboard thruster.

(NB: If the boat has Side-Power stabilizer and AC or DC thrusters the thruster location should be set as BOW-STB or STERN-STB. This so the hydraulic controller are shown at the left side in display and thruster(s) at the right side of the display.)

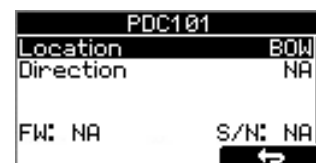

3.2 Direction

Values: NA (Not Available)

AC System - PDC 201 Setup

4.0 PDC 201

4.1 Location

Values: BOW/STERN/BOW-STB/STERN-STB
 Set the location for selected device. Use BOW or STERN in a conventional thruster system. In a system with two bow or stern thrusters (i.e a catamaran), use BOW or STERN for port thruster, BOW-STB or STERN-STB for starboard thruster.

(NB: If the boat has Side-Power stabilizer and AC or DC thrusters the thruster location should be set as BOW-STB or STERN-STB. This so the hydraulic controller are shown at the left side in display and thruster(s) at the right side of the display.)



4.2 Direction

Values: Normal (default)/Inverted
 Switches between Normal and Inverted running direction for the thruster.



5.0 PDC 301

5.1 Location

Values: BOW/STERN/BOW-STB/STERN-STB

Set the location for selected device. Use BOW or STERN in a conventional thruster system. In a system with two bow or stern thrusters (i.e a catamaran), use BOW or STERN for port thruster, BOW-STB or STERN-STB for starboard thruster.

(NB: If the boat has Side-Power stabilizer and AC or DC thrusters the thruster location should be set as BOW-STB or STERN-STB. This so the hydraulic controller are shown at the left side in display and thruster(s) at the right side of the display.)

PDC-301	
Location	BOW
Direction	Normal
Function	SAC
Max output	100%
FW: V1.001	S/N:302302

5.2 Direction

Values: Normal (default)/Inverted

Switches between Normal and Inverted running direction for the thruster.

PDC-301	
Location	BOW
Direction	Normal
Function	SAC
Max output	100%
FW: V1.001	S/N:302302

5.3 Function

Values: SAC (default), SRAC

Setup the control unit behavior.

-SAC: Tunnel speed thruster

-SRAC: SAC with SR150000 retract controller. SR150000 must be set as SRHP/SRAC.

PDC-301	
Location	BOW
Direction	Normal
Function	SAC
Max output	100%
FW: V1.001	S/N:302302

5.4 Max output

Values: 50% to 100% (Default 100%)

Set the maximum output thrust of PHC-301 in percent.

PDC-301 will scale the input signal to this value.

PDC-301	
Location	BOW
Direction	Normal
Function	SAC
Max output	100%
FW: V1.001	S/N:302302

5.5 Load share limit

Values: 0% to 100% (Default 100%)

The Load Sharing limitation allows the system to limit the combined load on the generator from a bow and stern thruster when both thrusters are used at the same time. The load sharing will dynamically limit the thrust request for each thruster depending on the joystick position and limit settings.

See *AC series thruster user manual (document ID 6054)* for a detailed explanation and setup guide.

PDC-301	
Direction	Normal
Function	SAC
Max output	100%
Load share limit	80%
FW: V1.015	S/N:302302

6.0 Main Switch

6.1 Location

Values: BOW/STERN/BOW-STB/STERN-STB

Set the location for selected device. Use BOW or STERN in a conventional thruster system. In a system with two bow or stern thrusters (i.e a catamaran), use BOW or STERN for port thruster, BOW-STB or STERN-STB for starboard thruster.

(NB: If the boat has Side-Power stabilizer and AC or DC thrusters the thruster location should be set as BOW-STB or STERN-STB. This so the hydraulic controller are shown at the left side in display and thruster(s) at the right side of the display.)



7.0 PPC - DC Speed Controller PPC520/ PPC820/ PPC840/ PPC800
 SR150000 - Control unit for SRV80/SRV100/SRV130/SRV170/SRV210/SRH
 SR61242 - Control unit for SR80/SR100

7.1 Location

Values: BOW/STERN/BOW-STB/STERN-STB

Set the location for selected device. Use BOW or STERN in a conventional thruster system. In a system with two bow or stern thrusters (i.e a catamaran), use BOW or STERN for port thruster, BOW-STB or STERN-STB for starboard thruster.

(NB: If the boat has Side-Power stabilizer and AC or DC thrusters the thruster location should be set as BOW-STB or STERN-STB. This so the hydraulic controller are shown at the left side in display and thruster(s) at the right side of the display.)

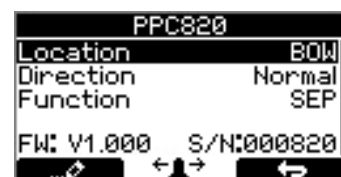

7.2 Direction

Values: Normal (default)/Inverted

Switches between Normal and Inverted running direction for the thruster

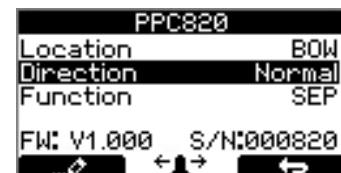

7.3 Function

Values: SR(V/L) ON/OFF, SRP, SRVP/SRLP, SEP, SRHP

Setup the control unit behaviour

- SR(V) ON/OFF: Retract thruster (SR6 1242 or SR150000) without speed controller (PPC520, PPC820, PPC800, PHC-024).

(NB: The joystick needs to be operated more than 50% for the thruster to run.)

- SEP: Tunnel speed thruster, PPC without retract.

- SRP: Retract SR61242 with PPC, both devices needs to be set to SRP.

- SRVP/SRLP: Retract SR150000 with PPC, both devices needs to be set to SRVP/SRLP.

- SRHP/SRAC: PHC or SAC with retract SRHP needs the PHC024 or PHC-3 hydraulic controller. SRAC needs the PDC-301 SAC controller.

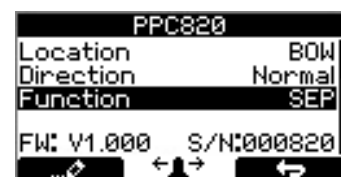

	PPC	SR150000	SR61242	PHC 024/ PHC-3	PDC-301
SR(V/L) ON/OFF		x	x		
SRP	x		x		
SRVP/SRLP	x	x			
SEP	x				
SRHP/SRAC		x		x	x

7.4 Max output

Values: 50%-100%

(this is only for PPC800 from V1.022 and PPC520/820/840 from V1.008)

Set the maximum output thrust of PPC in percent.

PPC will scale the input signal to this value.



7.5 Thermo Switch

Values: Disable (default), Enable

(this is only for PPC520/820/840 from V1.016)

Disable or Enables the thermo switch input on the PPC.

(NB: On PPC520/820/840, if the thermo switch input is closed to 0V at power-up then this function is automatically set to Enable.)

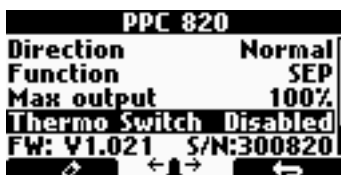

8.0 RCRS 1 & RCRS 2

8.1 BOW/STERN Thrust

Values: 0-100% (Default 75%)

Set the amount of thrust given by the remote control.

In a bow/stern configuration, try to balance the thrust so that the boat moves straight sideways when both thrusters are operated simultaneously with input from the remote only.

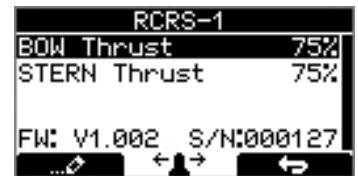

9.0 MSI8730

9.1 Location

Values: BOW/STERN/BOW-STB/STERN-STB

Set the location for selected device. Use BOW or STERN in a conventional thruster system. In a system with two bow or stern thrusters (i.e a catamaran), use BOW or STERN for port thruster, BOW-STB or STERN-STB for starboard thruster.

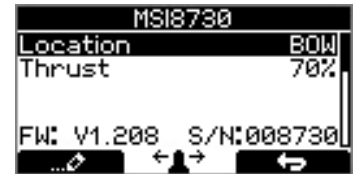

9.2 Thrust

Values: 0-100% (Default 70%)

Set the amount of thrust given by the remote control. In a bow/stern configuration, try to balance the thrust so that the boat moves straight sideways when both thrusters are operated simultaneously with input from the remote only.



10.0 ESI-1 (External Single Interface)

GW-1 (Gateway)

This devices will only show firmware version and serial number at the button.

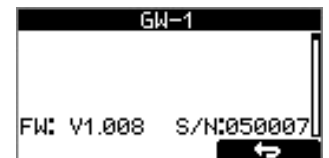

Calibrates the HOLD-function to get balanced thrust from the bow and stern thruster. If only one thruster or PJC221/PJC211 you will not get any balanced thrust, but you can adjust the maximum thrust from HOLD buttons. Hold-button represents 1/6 of the calibrated value.

(NB: HOLD CALIBRATION is not available until SETUP is completed.)



Default in systems without stabilizers

To start calibration, press the "+"-Hold button in the desired direction. For a first time calibration, the thrusters will start at 70%. A system previously calibrated will start with the last amount of thrust set.



Adjust power with the joystick.

Press the button below to save the calibration values.

Press the button below to cancel calibration without saving.

(NB: Setup calibration in one direction sets values for both directions.)

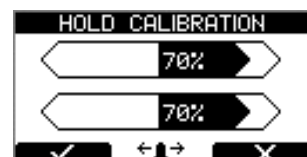

(only for PJC2xx panels with HW V2)

This function is for calibrating the joysticks, and requires a pin code to enter. This option is for service personnel only.



- Move between menu items with the (stern) joystick.
- Press the button below to select the highlighted menu entry.
- Press the button below to return to the previous menu.

THRUSTER INFO

Display info about the thrusters in the system. The number of thrusters/controllers found is shown in the upper right corner of the display.



The list of devices found can fill more than one screen. A scroll bar indicates the position of the selected item. The joystick(s) operates the thrusters as normal while info is displayed. This will be useful for troubleshooting, service and general system diagnostics. List will only show devices present on the S-link.



PPC DC Speed Controller PPC520/ PPC820/ / PPC800

SR150000 Control unit for SRV80/SRV100/SRV130/SRV170/SRV210/SRH

SR61242 Control unit for SR80/SR100

Motor Temp: Temperature measured at the electric motor brushes
(Not implemented in SR61242)

Contr. Temp: Temperature measured inside the controller
(Not implemented in SR61242)

Voltage: Motor Voltage measured at the controller

Thrust: Thrust level from joystick/hold buttons

°/A/kW: Retract angle (SR150000) / Motor Current (PPC) / Effect reading (PPC). SR150000 retract angle is 0° when fully deployed, and about 90° when retracted. Put SR150000 in service mode and operate the controller manually in an out to read the two end position angles for service and installation.

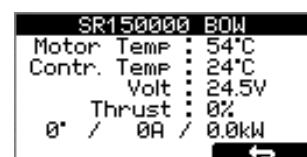

PDC101 and PDC 201 (Controller for AC electric thrusters)

Motor Speed: RPM on motor output shaft
 Motor Power: Motor power consumption in % (PDC201 only)
 Motor Temp: Temperature measured in motor
 Thrust: Thrust level from joystick/hold buttons

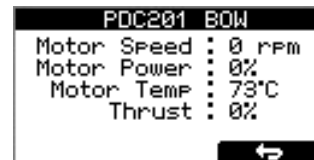
**PDC-301** (SAC controller)

Motor : speed (rpm), temperature (°C/°F), power (kW), AC current (A) & AC voltage (V).
 Thrust: Joystick thrust (%)

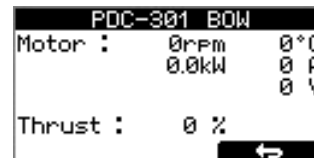

Display info about the control panel

FW: Version number, Firmware
 HW: Version number, Hardware
 S/N: Serial number of the control panel
 Voltage: S-link system voltage measured at the panel

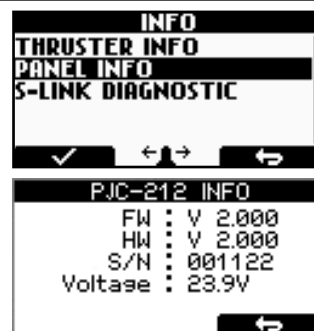

- Shows live update of S-link bus (CAN-bus) error status for the panel.
- Showing no error and signal condition is good.
- Example showing lots of error and very bad signal conditions.

DIAGNOSTIC DISPLAY**Rx Error Count**

Receive error counter. Error during reception increments the value. After every successful reception the value is decremented.

Tx Error Count

Transmit error counter. Error during transmit increments the value. After every successful transmit the value is decremented.

Last Error

Indicates the error condition of the last error detected. If a message has been transferred or received without error, it will show No Error.

Conditions: No Error, STUFF, FORM, ACK(Acknowledgment), BitRecessive, BitDominant & CRC.

Flag

BUS OFF: when Tx Error Count is greater than 255 and overflowed. (Tx Error Count will show 0 when in BUS OFF state)



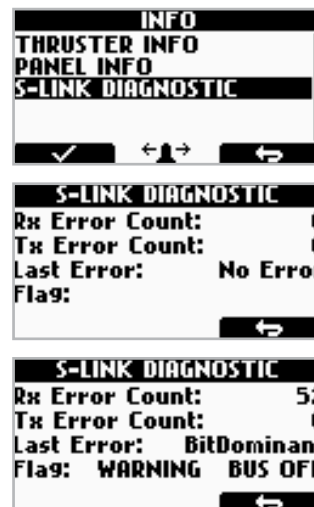

WARNING: when Rx Error Count or Tx Error Count has reached 96 counts

PASSIVE: when Rx Error Count or Tx Error Count is more than 127 counts

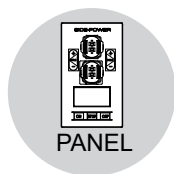
(NB: When S-link devices are hot plugged or disconnected to the bus or powered (when AMS is engaged and powering PPC and retract), it is not unnormal to see some values been incremented. But they will quickly decrement to 0 again. This will not cause any communication issues.)





- Move between parameters with the (stern) joystick.
- Press the button below  to return to the previous menu.
- Press the button below  to edit the selected parameter.
- Parameter value will start to blink, use joystick to alter value.
- Press the button below  to save the edited parameter.
- Press the button below  to cancel editing without saving.

11.0 SYSTEM PANEL

11.1 BACKLIGHT LEVEL

Values: 1-5

Set level of panel backlight in daylight mode.

1 is lowest intensity, 5 is the highest.



11.2 BACKLIGHT NIGHT COLOR

Values: GREEN, BLUE, RED, WHITE

Select color of backlight in nightlight mode.



11.3 BACKLIGHT NIGHT LEVEL

Values: 1-3

Set level of panel backlight in daylight mode, 1 is lowest intensity, 3 is the highest.



11.4 TIMER AUTO-OFF

Values: OFF, 01-60 min

Set the time from last use to auto panel shutdown. Set from 1-60 minutes in 5 minute steps (1 minute steps from 1 to 5 minutes) or OFF (panel will not turn off automatically). Values when retract on the boat: 1-30 min.



11.5 UNIT TEMPERATURE

Values: CELSIUS (Default), FAHRENHEIT

Set the panel temperature displaying unit.



11.6 WHEN RETRACT IS OUT

Values: NO WARNING (Default), WARNING EVERY 10sec

Select 'WARNING EVERY 10sec' for external buzzer or lamp warning every 10 seconds when retract is out. This will activate the internal relay for 0.2 seconds every 10 seconds while the retract is out. See page 26 for buzzer connections.



11.7 RELAY OUTPUT

Values: ALERT LEVEL 1, ALERT LEVEL 2, ALERT LEVEL 3 (Default)

ALERT LEVEL 1: When using the HOLD Function the relay output warns if the motor temperature is getting high or if the voltage is getting low.

ALERT LEVEL 2: The relay output warns for all alarms and warnings in the S-link system only when any device is sending thrust. Even when the panel is turned OFF.

ALERT LEVEL 3: The relay output warns for all alarms and warnings in the S-link system. Even when the panel is turned OFF.



See 'Alarm descriptions' in "Ext. buzzer activation at Alert Level" column for specific alarm action.

11.8 PANEL FACING

Values: FORWARD (Default), AFT

FORWARD: Is when panel is facing forward

AFT: Is when panel is facing aft. Display view will rotate 180 degree and joysticks thruster function will also rotate 180 degree.



When there is an alarm or a fault, the panel will show this alarm situation by changing LCD display backlight to red color.

The panel will also change to show "Alarm Info"  on the bottom of the screen, indicating that by pressing the corresponding button below, you will get information about what the problem is (examples below). Entering "Alarm Info" menu will silence the alarm on all PJC221 and PJC222 panels.

Some alarms needs an reset to stop alerting.

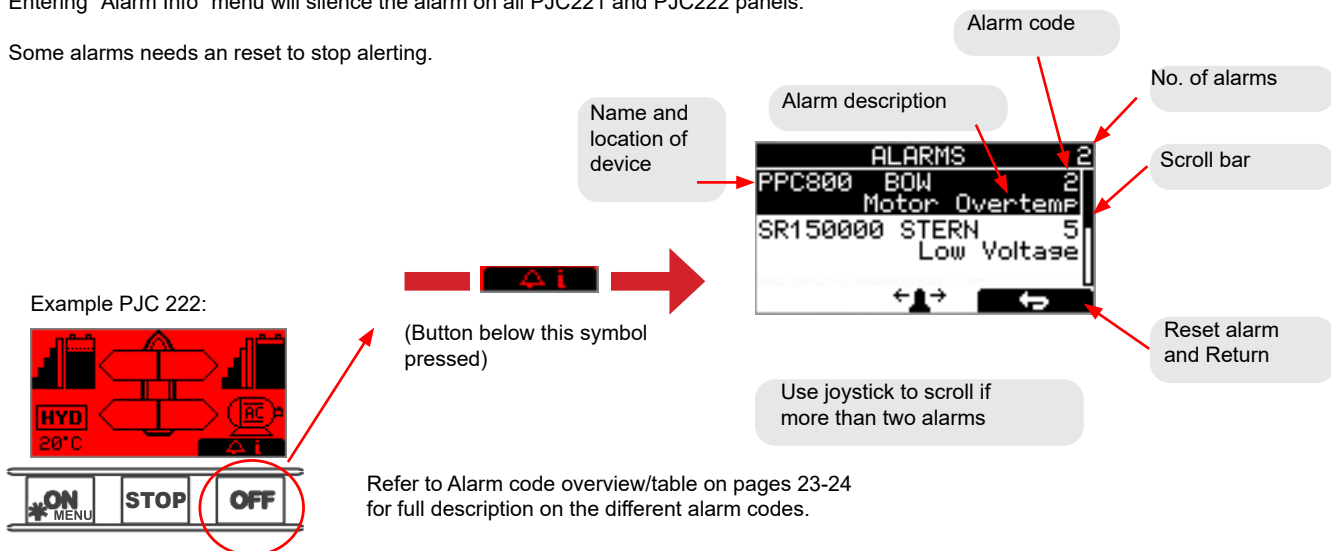

Example PJC 222:

(Button below this symbol pressed)

Refer to Alarm code overview/table on pages 23-24 for full description on the different alarm codes.

Use joystick to scroll if more than two alarms

Auto Reset

Some alarms are automatically reset when the fault is no longer present.

This means that this alarms don't need an manual reset action to be removed from the panel display and the audible alert to stop. At 'Alarm Description' pages in the "Auto Reset" column you can see which alarms that are auto reset.

SPECIFIC ALARMS

STOP BUTTON

Pressing the STOP button on a hydraulic panel will activate the dump valve and all hydraulic consumers will be disabled.

(NB: FOR EMERGENCY USE ONLY)

Panel will not run thrusters.

Pressing button below  will mute buzzer alarm at all panels and show the alarm info screen.

ALARM SHOWN ON INACTIVE PANELS!

This screen will be shown when any warning/alarm occurs.

Pressing button below  will mute buzzer alarm at all panels and show the alarm info screen.

WARNING! HIGH SPEED. STABILIZER NOT ACTIVE!

(Only for yachts equipped with a Side-Power Stabilizer system) Warning will show when yacht is driven at high speed with stabilizer system inactive. Please refer to the Stabilizer ECU manual for speed settings.

Pressing button below  will mute buzzer alarm at all panels and show the alarm info screen.



Reduced Power Mode
Thruster output is limited to 50 % thrust by Power Management System.

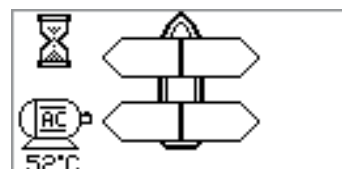
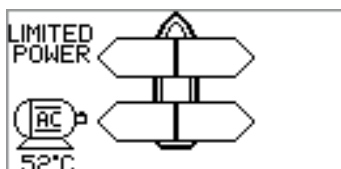

Power Not Available
Power Management System is preventing the thruster from operating.

Symbol alternating with AC motor symbol every 1sec.

*For detailed information on SAC power management operation see SAC user manual.



PJC221



PJC222



PJC211



PJC212

Status indicators for bow thruster. (Port bow thruster in a dual bow thruster setup).

Runtime indicator will be shown here in a single DC electric bow thruster setup.

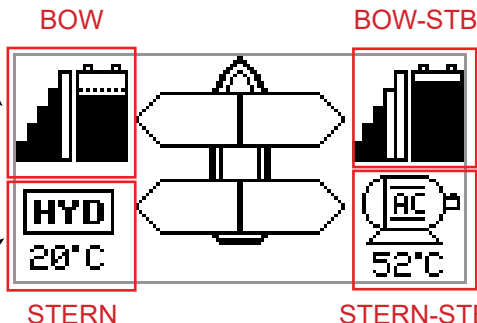

Status indicators for starboard bow thruster. Only shown in a dual bow thruster setup.

Battery indicator will be shown here in a single DC electric bow thruster setup.

Status indicators for stern thruster. (Port bow thruster in a dual stern thruster setup)

Runtime indicator will be shown here in a single DC electric stern thruster setup.

Status indicators for starboard stern thruster. Only shown in a dual stern thruster setup.

Battery indicator will be shown here in a single DC electric stern thruster setup.

Examples of display view for different panels applications:

PJC211:
DC Electric Bow thruster

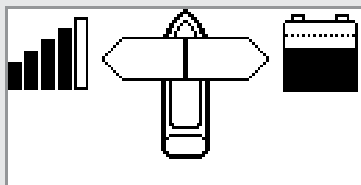

PJC221:
Hydraulic Bow thruster

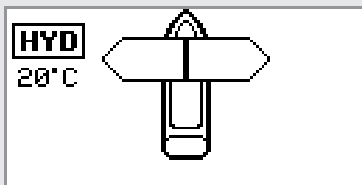

PJC221:
AC Electric Bow thruster

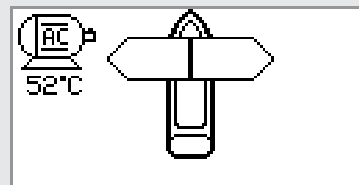

PJC211:
DC Electric Stern thruster

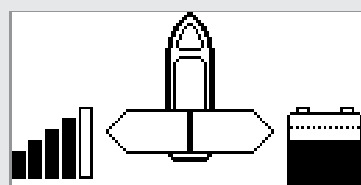

PJC221:
Dual AC Electric Bow thrusters

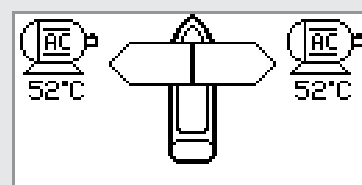

PJC221:
Dual Hydraulic Bow thrusters

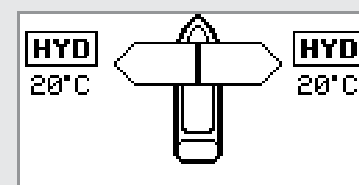

PJC212:
DC Electric Bow thruster
DC Electric Stern Thruster

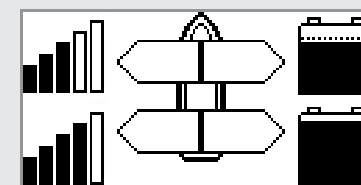

PJC222:
Hydraulic Bow thruster
Hydraulic Stern Thruster

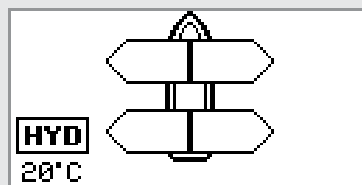

PJC222:
AC Electric Bow thruster
Hydraulic Stern Thruster

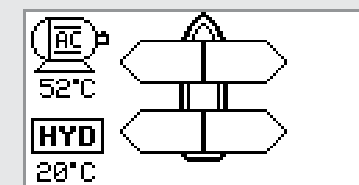

PJC212:
Dual DC Electric Bow thrusters
Dual DC Electric Stern thrusters

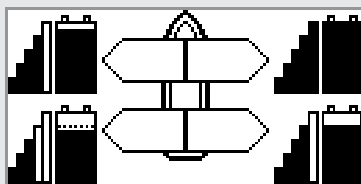

PJC222:
Dual Hydraulic Bow thrusters
Dual Hydraulic Stern thrusters

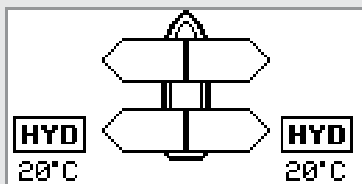

PJC222:
Dual AC Electric Bow thrusters
Dual AC Electric Stern thrusters

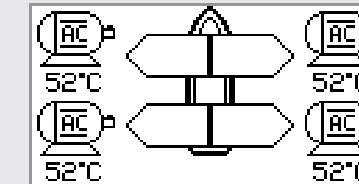

DC Thrusters:

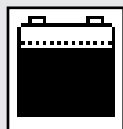

Battery indicator.
From 8.5V to 12V for 12V thrusters,
15V to 24V for 24V thrusters

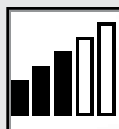

Motor temperature indicator.
From 70°C/ 158°F to 130°C/266°F.

Symbol shown when a DC Thruster is used in a dual bow or dual stern setup:

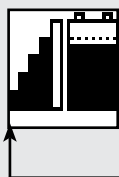

Battery indicator.
From 8.5V to 12V for 12V thrusters,
15V to 24V for 24V thrusters

Motor temperature indicator.
From 70°C/ 158°F to 130°C/266°F.

AC Thrusters:



Motor temperature indicator.

Hydraulic Thrusters:



Hydraulic oil temperature indicator.

Retractable Thrusters:



Symbol shown when the thruster deploys.



Symbol shown when the thruster retracts.



Symbol shown when the thruster is in position OUT.

When the thruster is deployed and no input is given via the joysticks/buttons over a 10 second period, the panel will give an audible signal every 10th second to tell that the thruster is still deployed.

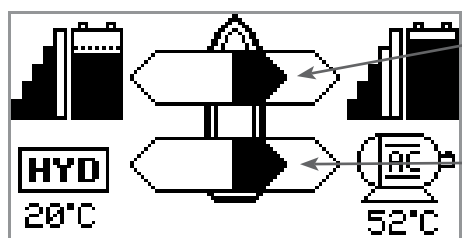

Thrust power and direction, Bow thruster(s)

Input from bow joystick on this panel.
The thrust indicator will be shown in this position on a single joystick panel if the thruster is defined as a bow thruster

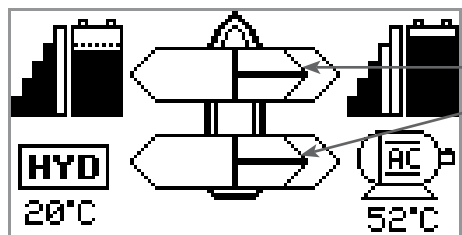

Thrust power and direction, Stern thruster(s)

Input from stern joystick on this panel
The thrust indicator will be shown in this position on a single joystick panel if the thruster is defined as a stern thruster.

Indicating amount of thrust set by other control units in the system, i.e additional PJC panels, 8700 Retract panel, input via 8730 S-link external switch interface, S-link remote control etc.

If two or more units are set to run the thruster in opposite direction, this information will not be shown.

The 'HOLD' function is for auto-running of bow and stern thrusters together in the direction of the arrows at selected power.

Press "+" for more and "-" for less power (6 steps). The 'HOLD' function is normally used to hold the boat into the dock while mooring. The 'HOLD' function can be deactivated by running any thruster in the opposite direction from any control unit.

The 'HOLD' function can be calibrated to get balanced thrust from the bow and stern thruster.

See the PJC control panel manual on how to calibrate.

For safety! When oil pressure goes below 10bar, the 'HOLD' function is deactivated.

The internal and external (if fitted) buzzer will give the following warning signals:

	Warning signals	Cause	Effect
1.	Single short beep every 2.4 sec.	<ul style="list-style-type: none"> Voltage below 9.3V/17.5V (12V/24V system). Temperature above 85°C/185°F. 	None
2.	Two short beeps every 2.4 sec.	<ul style="list-style-type: none"> Voltage below 8.9V/16.3V (12V/24V system). Temperature above 100°C/212°F. 	None
3.	Red backlight in display and continous short beeps.	<ul style="list-style-type: none"> Voltage below 8.5V/15V (12V/24V system). Temperature above 110°C/230°F. 	None
4.	Red backlight in display and continous short beeps.	If one or more of the thrusters enters an alarm state - Voltage below 8.0V/12.0V (12V/24V system) or temperature above 120°C/248°F.	"HOLD" function are cancelled and both thrusters will stop. Temperature must drop below 110°C/230°F before the thruster can be operated again. Low Voltage alarm must be reset from panel.

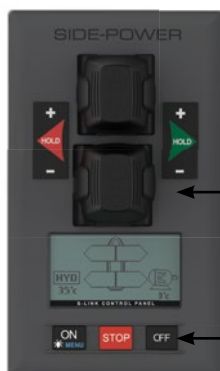

Move around in menus by using joystick.

Follow instructions on the screen and press the buttons below the symbols indicated on LCD screen.

Access menu system by pressing and holding Menu button for 3 seconds.

MAIN MENU ITEMS:

Move between main menu items with the (stern) joystick.

LANGUAGE	STABILIZER	SETUP	INFO	DEFAULT SETTINGS	PANEL SETUP
Language	Stabilizer (If installed)	Setup	Info	Default settings	Panel setup

BUTTON SYMBOLS

On the bottom line of the display, a symbol will be shown over the buttons below.

These symbols will show what function each corresponding button has in the selected menu entry.

Return to previous menu.	Select highlighted menu text / Save edited parameter.	Edit highlighted parameter.	Cancel editing without saving.	This symbol indicates that the (stern) joystick is used to move between menu items / parameters.



LANGUAGE

- Choose language by moving joystick: English, Norwegian, German, French, Spanish, Italian and Danish.
- Press the button below to set the language to the highlighted menu entry. A star (*) on each side indicates the language set.

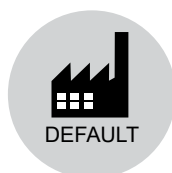

DEFAULT SETTINGS

- Reset all settings to factory default - follow instructions on screen
- Press the button below to confirm reset
- The following parameters/values will be set to the factory settings:

Language = English
 Backlight Level = 5
 Backlight Night Color = Green
 Backlight Nightlevel = 1
 Timer Auto-Off = 05 min
 Hold Calibration = 70% Bow and Stern

All system devices will be erased from memory.
 (Setup procedure must be followed to reconfigure the system)

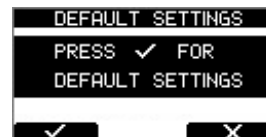

(Default in systems with stabilizers)

STABILIZER

(Shown only for yachts equipped with a Side-Power Stabilizer system)

- Press the button below to edit the selected parameter. ON/OFF will start to blink, use joystick to alter value.
 Press the button below to save edited parameter to device.

1. Stabilizer:

- Values: ON/OFF
- Switches the stabilizer ON or OFF.



2. AnySpeed:

- Values: ON/OFF
- Switches the zero speed/at anchor stabilization ON or OFF.



"Err. No."	Errors shown in display	"Auto Reset"	"Ext. buzzer activation at Alert Level"	Description	Action
1	Motor Overcurrent		2 ⁽²⁾ , 3	Motor current too high.	"Thruster must be serviced by authorized personnel, reset or power OFF/ON PPC ⁽¹⁾ ."
2	Motor Overtemp	Yes	2 ⁽²⁾ , 3	"Motortemp has been over 120°C/248°F."	Motor cool down below 110°C /230°F.
3	Controller Overtemp		2 ⁽²⁾ , 3	"PPC ⁽¹⁾ temp has been over 80°C/176°F."	PPC ⁽¹⁾ cool down below 45°C/113°F.
4	Controller Overtemp		2 ⁽²⁾ , 3	"SR150000 temp has been over 80°C/176°F."	SR150000 cool down below 45°C /113°F.
5	Low Voltage		2 ⁽²⁾ , 3	Low motor voltage alarm when motor is running. 12V thruster below 8.00V 24V thruster below 12.00V	Recharge battery, reset or power OFF/ON device.
6	Thermoswitch	Yes	2 ⁽²⁾ , 3	Thermo switch input is activated and there is an open circuit.	The thruster needs to cool down before operating again.
7	IPC Error		2 ⁽²⁾ , 3	Motor relay fault	"Turn off thruster battery main switch. Thruster must be serviced by authorized personnel."
8	Critical Error		2 ⁽²⁾ , 3	PPC ⁽¹⁾ output fail	PPC ⁽¹⁾ must be sent for service.
9	Low Motor Current		2 ⁽²⁾ , 3	Thruster uses no power	Check thruster connections or motor dead!
10	Motor Contactor		2 ⁽²⁾ , 3	No current on motor relay coil.	Check motor relay connections, short circuit or relay dead!
11	System Error		2 ⁽²⁾ , 3	Fatal error	Device must be serviced by authorized personnel
12	No Communication		2 ⁽²⁾ , 3	No communication with device	Check S-Link cables and power connections.
13	Motor Temp Sensor		2 ⁽²⁾ , 3	Motor temperature sensor fail	Check for an open circuit on the temp sensor on the motor
14	Supply Voltage Fault		2 ⁽²⁾ , 3	No power	Check power connections
15	Fuse Blown		2 ⁽²⁾ , 3	Fuse blown	Replace fuse or check if main cable from battery and main cable to thruster has been switched
16	Manual Override	Yes	2 ⁽²⁾ , 3	Main switch manually overridden	Pull main switch
17	Motion OUT Fault		2 ⁽²⁾ , 3	Retract obstructed while deploying	Turn off all panels. Go for lower speed/deeper water and retry.
18	Motion IN Fault		2 ⁽²⁾ , 3	Retract obstructed while retracting	Turn panel on and manually override main switch. Remove obstruction and try again.

1. PPC520, PPC820, PPC800, PPC840

2. Buzzer is only activated when any device is sending thrust on the S-link bus.

"Err. No."	Errors shown in display	"Auto Reset"	"Ext. buzzer activation at Alert Level"	Description	Action
19	Actuator Fault		2 ⁽²⁾ , 3	Actuator not getting any power	"Check actuator connection or power to actuator. Reset alarm in alarm menu on PJC 211/212/221/222 or recycle power."
20	Pos.Sensor Fault		2 ⁽²⁾ , 3	Retract position sensor fail	Check position sensor cables and for sensor damage.
21	In Service Mode	Yes	2 ⁽²⁾ , 3	"Retract controller in service mode. Switch no. 4 is ON."	Check dipswitch setting on retract control box.
22	High Oil Temp	Yes	1, 2 ⁽²⁾ , 3	"Hydraulic oil temperature is higher than 75°C /167°F."	"Stop running and wait for temperature to drop. Check if cooling pump is running."
23	Low Oil Level		1, 2 ⁽²⁾ , 3	Hydraulic oil level is too low	Fill more hydraulic oil to the hydraulic tank.
24	Warning Return Filter	Yes	2 ⁽²⁾ , 3		Return filter element required replacing.
25	Warning Pressure Filter	Yes	2 ⁽²⁾ , 3		Pressure filter element required replacing.
26	Warning High Speed	Yes	1, 2 ⁽²⁾ , 3	"WARNING! High Speed. Stabilizer not active!"	
27	Stabilizer Fault	Yes	1, 2 ⁽²⁾ , 3	Any Stabilizer alarm.	See stabilizer panel for more info.
28	AC Motor Overtemp	Yes	1, 2 ⁽²⁾ , 3	"Hydraulic AC motor power pack overtemp. Higher than 120°C/248°F."	Stop running and wait for temperature to drop.
29	AC Motor Sensor Fail		2 ⁽²⁾ , 3	"Hydraulic AC motor power pack temp sensor open circuit"	Check sensor cables.
30	Temperature Warning	Yes	2 ⁽²⁾ , 3 ⁽²⁾	High temperature warning.	Warns that the motor temperature is getting high.
31	Motor Overtemp	Yes	1, 2 ⁽²⁾ , 3	High temperature Alarm.	See SAC manual for more details.
32	VFD Warning	Yes	2 ⁽²⁾ , 3	There is a warning from VFD.	Check VFD for more details.
33	VFD Not Ready	Yes	2 ⁽²⁾ , 3	The VFD is not ready.	Check VFD for more details.
34	VFD Fault		1, 2 ⁽²⁾ , 3	VFD has an Alarm.	Check VFD for more details.
35	Warning Low Voltage	Yes	2 ⁽²⁾ , 3 ⁽²⁾	Low motor voltage warning when motor is running. 12V thruster below 9.30V 24V thruster below 17.50V	
36	Not Calibrated	Yes	2 ⁽²⁾ , 3	Shaft Not Calibrated	See manual for how to calibrate.
37	VFD Com. Fault		2 ⁽²⁾ , 3	No Modbus communication with VFD	Check VFD Modbus cables and power.
38	Cooling Fan Fault		2 ⁽²⁾ , 3	Cooling fan stopped running, or running too slow	Device must be sent for service
39	Interlock		2 ⁽²⁾ , 3	S-link communication between PPC and retract controller are missing	-Check PPC or retract controller has power. -Check S-Link connections to PPC and retract controller. -Check if not PPC or SR150000/ SR61242 is wrongly setup as SRP or SRVP/SRLP.

1. PPC520, PPC820, PPC800, PPC840

2. Buzzer is only activated when any device is sending thrust on the S-link bus.

Fault Code	Description	Cause	Action
10500.0.10	PHC Oil Level - Level Low	Hydraulic oil level is low	"-Limit use of thruster -Inspect hydraulic oil level -Check system for leaks and refill hydraulic oil"
10500.0.13	PHC Oil Level - Open Circuit	Analog oil level sensor open circuit	"-Sensor not connected or wire break. -Verify sensor type in parameter 0201 -Disconnect sensor and measure that sensor resistance value is in range 0-180ohm."
10501.0.11	PHC Oil Temp - Level High	Oil temperature higher than 75°C (167°F)	"-Limit use of thruster to prevent temperature to rise. -Check if cooling pump is running and there is cooling water flow. -Inspect seawater filter -Verify that cooling pump is enabled in parameter 0301"
10501.0.13	PHC Oil Temp - Open Circuit	Analog oil temp sensor open circuit	"-Sensor not connected or wire break. - Disconnect sensor and measure that sensor resistance value is in range 104ohm-147Kohm -Wrong sensor is defined in parameter 0201"
10501.0.16	PHC Oil Temp - Short Circuit	Analog oil temp input short circuit	"-Input shorted to GND, check wiring/sensor -Disconnect sensor and measure that sensor resistance value is in range 104ohm-147Kohm"
10502.0.13	PHC Stabilizer Pressure - Open Circuit	Stabilizer pressure sensor open circuit	"-Sensor not connected or wire break. -System incorrectly configured with stabilizer, parameter 1001 -Replace sensor"
10502.0.16	PHC Stabilizer Pressure - Short Circuit	Stabilizer pressure sensor short circuit	"-Wires shorted or sensor defective, check wiring/sensor -Replace sensor"
10502.0.19	PHC Stabilizer Pressure - Under Limit	Stabilizer pressure has dropped below 20bar.	"-Check accumulator charge pressure -Check PTO pressure (if PTO powered) -Check system for oil leaks -Check generator power supply to the VFD (is VFD motor speed maximum when pressure alarming low)"
10502.0.20	PHC Stabilizer Pressure - Over Limit	"Stabilizer pressure is higher than: parameter 1013 PTO OVER-PRESSURE FAULT LEVEL running from PTO (FW V1.029 an older, set point + 30bar running from PTO) or set point + 15bar running from AC motor"	"-Check Parameter 1013 PTO OVER-PRESSURE FAULT LEVEL -Check PTO pressure setting -Check accumulator charge pressure -Check unload valve operation"
10502.0.26	PHC Stabilizer Pressure - VALUE MAX	Stabilizer pressure reached sensor max value.	"-Check that correct sensor is fitted -Check that sensor range parameter 1010 match the sensor -Check PTO pressure setting"
10502.0.200	PHC Stabilizer Pressure - Timeout	Stabilizer pressure has not reached 60% of set point parameter 1003 after 30sec.	"-Check pump feed shutoff valve. -Check PTO pressure (if PTO powered) -Check system for oil leaks"
10503.0.13	PHC System Pressure - Open Circuit	System pressure sensor open circuit	"-Sensor not connected or wire break. -Verify system pressure, parameter 0104"
10503.0.16	PHC System Pressure - Short Circuit	System pressure sensor short circuit	"-Wires shorted or sensor defective, check wiring/sensor -Replace sensor"
10504.0.13	PHC AI 1 - Open Circuit	Analog Input 1 (4-20mA) sensor open circuit	-Sensor not connected or wire break.
10504.0.16	PHC AI 1 - Short Circuit	Analog Input 1 (4-20mA) sensor short circuit	"-Wires shorted or sensor defective, check wiring/sensor -Replace sensor"
10505.0.13	PHC AI 2 - Open Circuit	Analog Input 2 (4-20mA) sensor open circuit	-Sensor not connected or wire break.
10505.0.16	PHC AI 2 - Short Circuit	Analog Input 2 (4-20mA) sensor short circuit	"-Wires shorted or sensor defective, check wiring/sensor -Replace sensor"
10508.0.13	PHC DOUT AC PUMP UNLOAD - Open Circuit	AC Pump Unload valve open circuit	"-Check for open circuit, power consumption < 5.0 Watt -System incorrectly configured with stabilizer, parameter 1001"
10508.0.51	PHC DOUT AC PUMP UNLOAD - Current High	AC Pump Unload valve current higher than 4.0A	-Check wires and connections for short circuit
10509.0.13	PHC DOUT ACCUMULATOR DUMP - Open Circuit	Accumulator Dump valve open circuit	"-Check for open circuit, power < 5.0 Watt -System incorrectly configured with stabilizer, parameter 1001"
10509.0.51	PHC DOUT ACCUMULATOR DUMP - Current High	Accumulator Dump valve current higher than 4.0A	-Check wires and connections for short circuit
10510.0.13	PHC DOUT STABILIZER - Open Circuit	Stabilizer valve open circuit	"-Check for open circuit, power consumption < 5.0 Watt -System incorrectly configured with stabilizer, parameter 1001"
10510.0.51	PHC DOUT STABILIZER - Current High	Stabilizer valve current higher than 4.0A	-Check wires and connections for short circuit
10511.0.13	PHC DOUT COOLING PUMP HYDRAULIC - Open Circuit	Hydraulic Cooling Pump valve open circuit	"-Check for open circuit, power consumption < 5.0 Watt -Wrong cooling pump configured, parameter 0301"
10511.0.51	PHC DOUT COOLING PUMP HYDRAULIC - Current High	Hydraulic Cooling Pump valve current higher than 4.0A	-Check wires and connections for short circuit
10512.0.13	PHC DOUT LS DUMP - Open Circuit	LS-Dump valve open circuit	"-Check for open circuit, power consumption < 5.0 Watt -System wrong configured with thrusters, parameter 2001 or 2101"
10512.0.51	PHC DOUT LS DUMP - Current High	LS-Dump valve current higher than 4.0A	-Check wires and connections for short circuit
10513.0.51	PHC DOUT PUMP #2 - Current High	Pump #2 valve current higher than 4.0A	-Check wires and connections for short circuit
10514.0.13	PHC DOUT 5 - Open Circuit	Digital Output 5 is configured as crossover and output is open circuit	"-Check for open circuit, power consumption < 5.0 Watt -Output configured wrong, parameter 0505"
10514.0.51	PHC DOUT 5 - Current High	Digital Output 5 current higher than 4.0A	-Check wires and connections for short circuit
10515.0.13	PHC DOUT 6 - Open Circuit	Digital Output 6 is configured as crossover and output is open circuit	"-Check for open circuit, power consumption < 5.0 Watt -Output configured wrong, parameter 0506"
10515.0.51	PHC DOUT 6 - Current High	Digital Output 6 current higher than 4.0A	-Check wires and connections for short circuit
10516.0.13	PHC DOUT 3 - Open Circuit	Digital Output 3 is configured as crossover and output is open circuit	"-Check for open circuit, power consumption < 5.0 Watt -Output configured wrong, parameter 0503"

Fault Code	Description	Cause	Action
10516.0.51	PHC DOUT 3 - Current High	Digital Output 3 current higher than 4.0A	-Check wires and connections for short circuit
10517.0.13	PHC DOUT 2 - Open Circuit	Digital Output 2 is configured as crossover and output is open circuit	"-Check for open circuit, power consumption < 5.0 Watt -Output configured wrong, parameter 0502"
10517.0.51	PHC DOUT 2 - Current High	Digital Output 2 current higher than 4.0A	-Check wires and connections for short circuit
10518.0.13	PHC DOUT 1 - Open Circuit	Digital Output 1 is configured as crossover and output is open circuit	"-Check for open circuit, power consumption < 5.0 Watt -Output configured wrong, parameter 0501"
10518.0.51	PHC DOUT 1 - Current High	Digital Output 1 current higher than 4.0A	-Check wires and connections for short circuit
10519.0.13	PHC DOUT 4 - Open Circuit	Digital Output 4 is configured as crossover and output is open circuit	"-Check for open circuit, power consumption < 5.0 Watt -Output configured wrong, parameter 0504"
10519.0.51	PHC DOUT 4 - Current High	Digital Output 4 current higher than 4.0A	-Check wires and connections for short circuit
10520.0.51	PHC ECI PUMP POWER FEED - Current High	ECI cooling pump power current higher than 8.0A	"-Check pump cable for damage and short circuits -Make sure the connector on the cooling pump is correct inserted. -Replace cooling pump"
10521.0.51	PHC Bow Thruster Power - Current High	Bow thruster PVG feed current higher than 3.0A	-Check PVG wires and connections for short circuit
10522.0.51	PHC Stern Thruster Power - Current High	Stern thruster PVG feed current higher than 3.0A	-Check PVG wires and connections for short circuit
10523.0.51	PHC Thruster Power - Current High	Bow or Stern PVG feed current higher than 3.3A	Check all bow and stern PVG signal wires for short circuits
10524.0.51	PHC ECI Cooling Pump - Current High	ECI cooling pump current higher than 13.0A	"-Check ECI cooling pump cable for damage and short circuits -Replace ECI cooling pump"
10524.0.53	PHC ECI Cooling Pump - Overvoltage	ECI cooling pump overvoltage, voltage higher than 33.0V	"-Check PHC-3 input voltage is below 33.0V -Replace ECI cooling pump"
10524.0.54	PHC ECI Cooling Pump - Undervoltage	ECI cooling pump under voltage, voltage is lower than 18.0V	"-Check PHC-3 input voltage is higher than 18.0V -Replace ECI cooling pump"
10524.0.55	PHC ECI Cooling Pump - Overtemp	ECI cooling pump temperature higher than 100°C (212°F)	"-Check ECI cooling pump for damages -Replace ECI cooling pump"
10524.0.100	PHC ECI Cooling Pump - No Communication	No communication with ECI cooling pump	"-Check if ECI pump is connected -Check wires to ECI pump for open circuits -Check power supply cooling pump -Wrong cooling pump configured, parameter 0301"
10524.0.205	PHC ECI Cooling Pump - HW FAULT	ECI cooling pump hardware fault	-Replace ECI cooling pump
10526.0.0	PHC ECI Cooling Pump Blocked - -	ECI cooling pump is blocked	"-Reset fault and if fault reappears, cooling pump need service or replacement. -Check pump inlet for obstacles"
10527.1.0	PHC VFD Not Ready Instance 1 -	VFD not ready	-VFD external run enable/power available signal is lost.
10528.1.10	PHC VFD ABB Parameter Instance 1 Level Low	ABB ACS550 parameter values 2001 or 2002 cannot be a negative value.	-Check ABB ACS550 parameter 2001 and 2002.
10529.0.19	PHC ECI Cooling Pump Speed - Under Limit	ECI pump motor speed under limit, below 100rpm	"-Check hose for dirt -Check pump inlet for obstacles"
10530.0.201	PHC PTO ENGINE INSTANCE - INIT FAIL	Parameter 1011-PTO ENGINE INSTANCE is not defined	-Set parameter 1011-PTO ENGINE INSTANCE
36000.1.24	ABB ACS550 Instance 1 Fault	ABB ACS550 fault	Se ABB ACS550 drive for more details
36002.1.24	VACON Instance 1 Fault	VACON VFD Fault	Se VACON drive for more details
36003.1.24	ABB ACS580 Instance 1 Fault	ABB ACS580 fault	Se ABB ACS580 drive for more details
36100.1.100	VFD Instance 1 No Communication	Lost communication with VFD	"-VFD not powered up -VFD communication cable not connected or incorrectly wired"
36103.1.0	VFD IN LOCAL Instance 1 -	VFD in local mode	-Switch VFD to remote mode

Fault Code	Description	Cause	Action
10600.0.208	SR150000 Fault - INTERLOCK	Retract Interlock	-Check if retract is depoyed. -No communication with Retract Controller, check Retract Controller has power. -Check PDC-301 and Retract Controller setup.
36100.1.24	VFD Instance 1 Fault	VFD faulted	-See VFD for more information
36100.1.100	VFD Instance 1 No Communication	PDC-301 has no MODBUS communication with VFD.	-Check communication cable with VFD -Check if VFD has power
36101.1.200	VFD PMS Instance 1 Timeout	VFD is not ready within 60 after power request.	-Check if VFD has power
36101.1.204	VFD PMS Instance 1 SIGNAL LOST	Lost Power Management signal from VFD, VFD not avilable anymore.	-Check VFD for more information.
36103.1.0	VFD IN LOCAL Instance 1 -	VFD in Local or Hand Mode	-Change mode in VFD panel.

Dotted lines for writing notes.

Area with horizontal dotted lines for writing notes.

Area with horizontal dotted lines for writing notes.

Fill in the type, location and serial numbers of the S-link devices installed.
Keeping this as a reference will make the setup procedure easier!

S-link device	Location	Serial number
(ie Thruster, AMS, PPC etc)	(Bow, Bow-STB, Stern, Stern-STB)	

Worldwide sales and service



www.side-power.com



SLEIPNER MOTOR * AS P.O. Box 519 * N-1612 Fredrikstad * Norway

The information given in the document was correct at the time it was published. However, Sleipner Motor AS can not accept liability for any inaccuracies or omissions it may contain. Continuous product improvement may change the product specifications without notice. Therefore, Sleipner Motor AS can not accept liability for any possible differences between product and document.

MC_0030