

FURUNO

OPERATOR'S MANUAL

SC Setting Tool

	SC-33
	SCX-20
Applicable model	SCX-21

IMPORTANT NOTICES

General

- This manual has been authored with simplified grammar, to meet the needs of international users.
- The operator of this equipment must read and follow the instructions in this manual. Wrong operation or maintenance can void the warranty or cause injury.
- Do not copy any part of this manual without written permission from FURUNO.
- If this manual is lost or worn, contact your dealer about replacement.
- The contents of this manual and the equipment specifications can change without notice.
- The example screens (or illustrations) shown in this manual can be different from the screens you see on your display. The screens you see depend on your system configuration and equipment settings.
- Save this manual for future reference.
- Any modification of the equipment (including software) by persons not authorized by FURUNO will void the warranty.
- All brand, product names, trademarks, registered trademarks, and service marks belong to their respective holders.
- Windows and Visual C++ are a registered trademark of Microsoft Corporation in the United States and other countries.

TABLE OF CONTENTS

FOREWORD	iii
1. OPERATIONAL OVERVIEW	1
1.1 Minimum PC Requirements	1
1.2 Connection with a PC.....	1
1.2.1 NMEA2000 network connection (SC-33/SCX-20)	1
1.2.2 NMEA0183 serial connection (SCX-21)	3
1.3 How to Install the SC Setting Tool	3
1.4 How to Start and Close the SC Setting Tool	5
1.4.1 How to connect a PC to the SATELLITE COMPASS™	5
1.4.2 How to close the SC setting tool.....	8
1.5 How to Uninstall the SC Setting Tool	8
2. HOW TO SETUP THE MENU	9
2.1 Display Layout.....	9
2.2 [GNSS Setup] Tab	10
2.3 [Sensor Setup] Tab	11
2.4 [PGN Setup] Tab (SC-33/SCX-20 Only)	14
2.5 [Port Setup] Tab (SCX-21 Only).....	15
2.6 [Simple Diagnostic] Tab	16
2.7 [Advanced Diagnostic] Tab (SCX-21 Only).....	18
2.8 [System Information] Tab (SCX-20/SCX-21 Only).....	19
2.9 [Restart/Reset] Tab	20
2.10 [Sky Plot] Tab.....	21
2.11 [Debug Monitor] Tab (SCX-20/SCX-21 Only)	22
MENU TREE	AP-1

FOREWORD

Introduction

This manual shows how to setup the SATELLITE COMPASS™, using the SC setting tool.

The SC setting tool runs on a commercially available PC which is connected to the SATELLITE COMPASS™ through the NMEA2000 network connection (SC-33/SCX-20) or NMEA0183 serial connection (SCX-21). Use this software for the initial setting after the installation, setting adjustment, or performance check in the maintenance. This software is available for the SC-33.

This software can be downloaded from the quick response code shown right.



Standards Used in this Manual

Display examples in this manual are taken from a Windows®7 PC. Menus and settings may differ slightly depending on your operating system.

1. OPERATIONAL OVERVIEW

1.1 Minimum PC Requirements

The following table shows the minimum specifications required to run the SC setting tool:

Item	Requirements
CPU	1 GHz or more
RAM	1 GB for 32bit; 2 GB for 64bit
Screen Resolution	1280×720 or more
Operating System (OS)	Windows®7 (32 bit, 64 bit), Windows®10 (32 bit, 64 bit)
OS Language	English or Japanese
Interface	USB port (USB2.0 compatible)

1.2 Connection with a PC

1.2.1 NMEA2000 network connection (SC-33/SCX-20)

You can connect the PC and SATELLITE COMPASS™ (SC-33/SCX-20) via the NMEA2000 network. Prepare a CAN-USB converter to connect the PC to the SATELLITE COMPASS™. When your CAN-USB converter is USBcan II or CANUSB, a drop cable is also required to connect the CAN-USB converter to the NMEA2000 backbone.

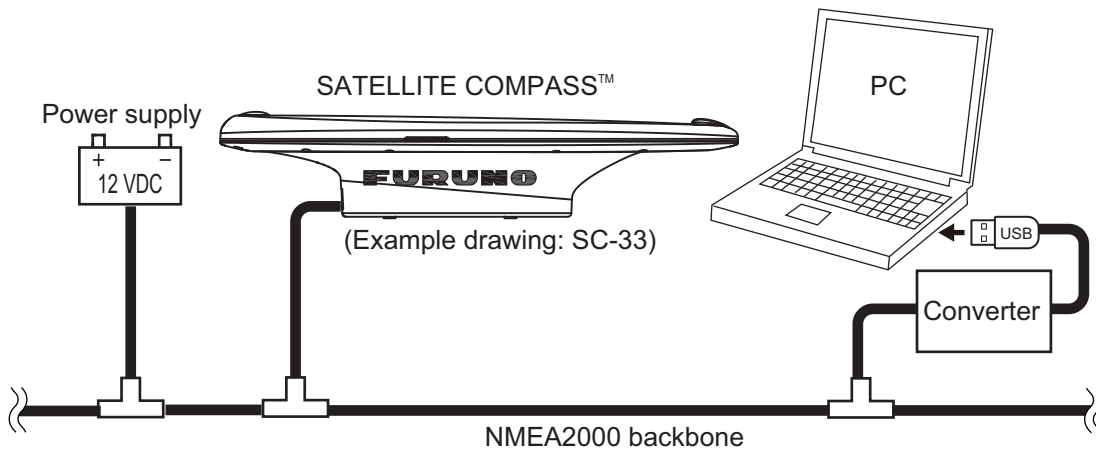

CAN-USB converter

Prepare either one of the following converters:

Manufacturer	Model
Kvaser Inc.	USBcan II
	Kvaser Leaf Light HS v2 M12
LAWICEL AB	CANUSB

Note: A software driver is required to use the CAN-USB converter or NMEA2000 gateway. For detailed installation instructions, refer to the operator’s manual of the converter or the official website of the manufacturer.

- For USB canII/Kvaser Leaf Light HS v2 M12: Use the program CD supplied with the CAN-USB converter to install the driver. When you install the driver, select the appropriate driver according to the OS for your PC.
- For CANUSB: Download the driver for 32 bit OS from the following URL and install it. Even if you use the PC of a 64 bit OS, you should also install the driver for 32 bit OS.
<http://www.ftdichip.com/Drivers/D2XX.htm>

Drop cable

When your CAN-USB converter is USBcan II or CANUSB, prepare a drop cable (type: M12-05BFFM-010/020/060) between the converter and the NMEA2000 backbone. Attach a D-SUB (9 pin) connector to the unterminated end of the cable, referring to the following table.

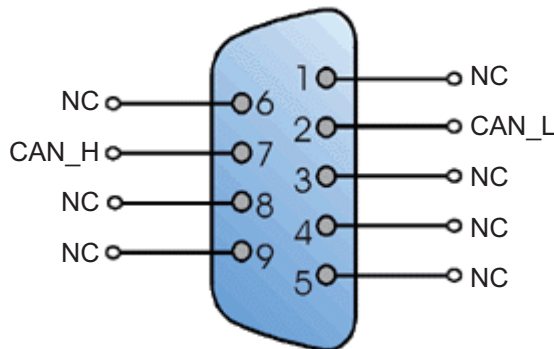

Pin No.	Signal	Color
1	NC	-
2	CAN_L	Blue
3	NC	-
4	NC	-
5	NC	-
6	NC	-
7	CAN_H	White
8	NC	-
9	NC	-

Note: Red and black wires of the M12-05BFFM-010/020/060 cable are not used.

1. OPERATIONAL OVERVIEW

1.2.2 NMEA0183 serial connection (SCX-21)

You can connect the PC and SATELLITE COMPASS™ (SCX-21) via the NMEA0183 serial connection. Prepare a serial-USB converter (local supply), between the PC and the NMEA0183 port. For the serial-USB converter, use the HuMANDATA USB-003 Rev6.

A software driver is required to use the HuMANDATA USB-003 Rev6. Download the driver from the program CD supplied with the converter or official website of the manufacturer, then install the driver. The URL of the driver download page is as follows:

<https://www.hdl.co.jp/en/faspc/Drivers/>

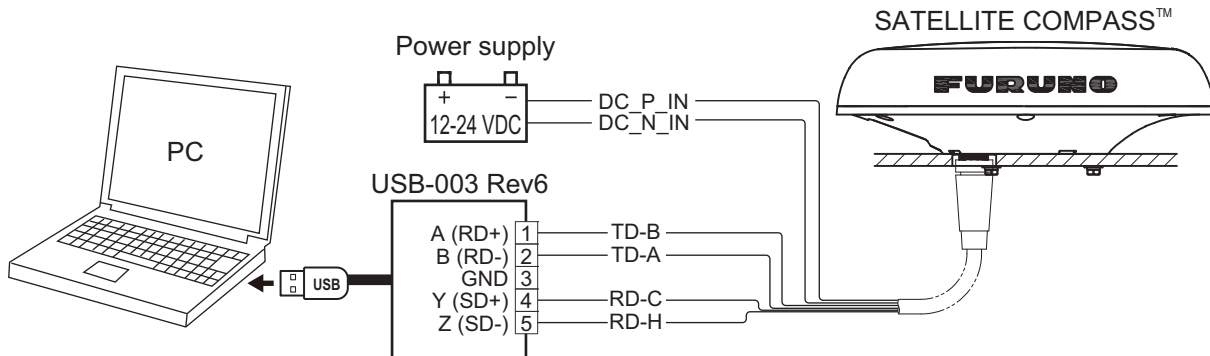

1.3 How to Install the SC Setting Tool

The executable file of the SC setting tool must be downloaded beforehand, using the quick response code shown right.



Install the SC setting tool as follows:

Note: Login as administrator to install the SC setting tool.

1. Run the executable file of the SC setting tool (file name: SC_Setting_Tool_Installer.msi). The following setup wizard appears.

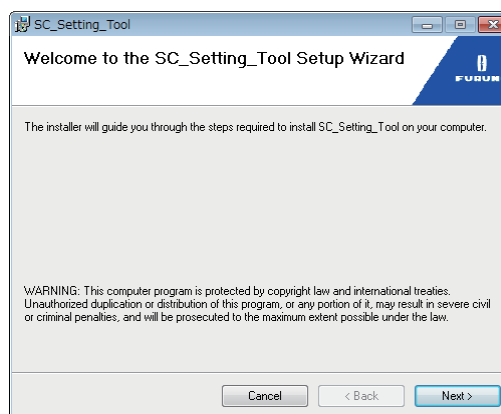

- Click the [Next] button to continue.

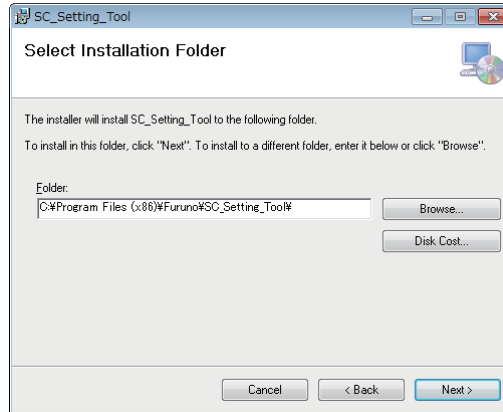

- Click the [Next] button to continue.

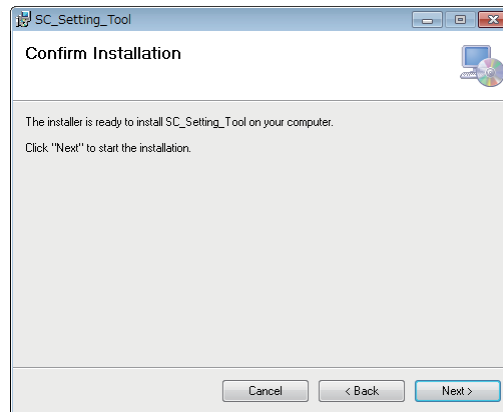

- Click the [Next] button to start the software installation.
The progress bar is shown while the SC setting tool is being installed. After completing the installation, the confirmation message appears.

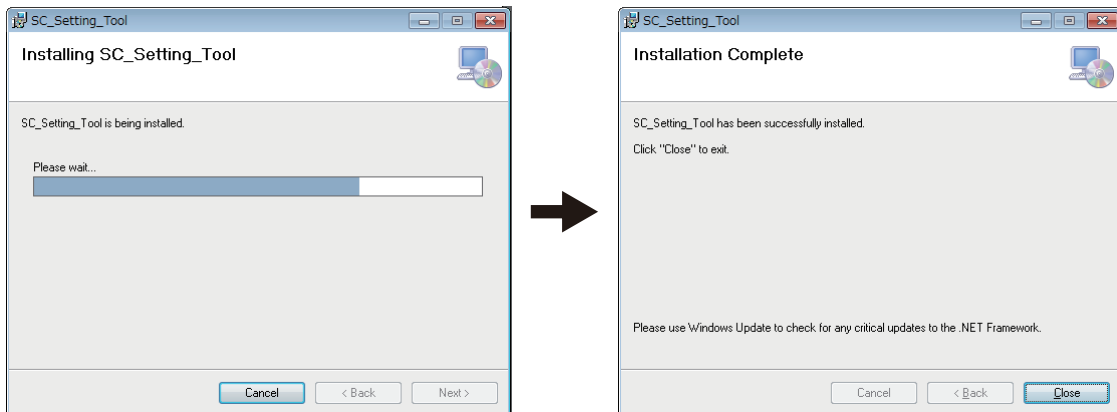

- Click the [Close] button to close the setup wizard.
The shortcut icon for the SC setting tool is created on the desktop automatically after the installation.



1.4 How to Start and Close the SC Setting Tool

1.4.1 How to connect a PC to the SATELLITE COMPASS™

1. Make the connections shown below.

NMEA2000 network connection (SC-33/SCX-20)

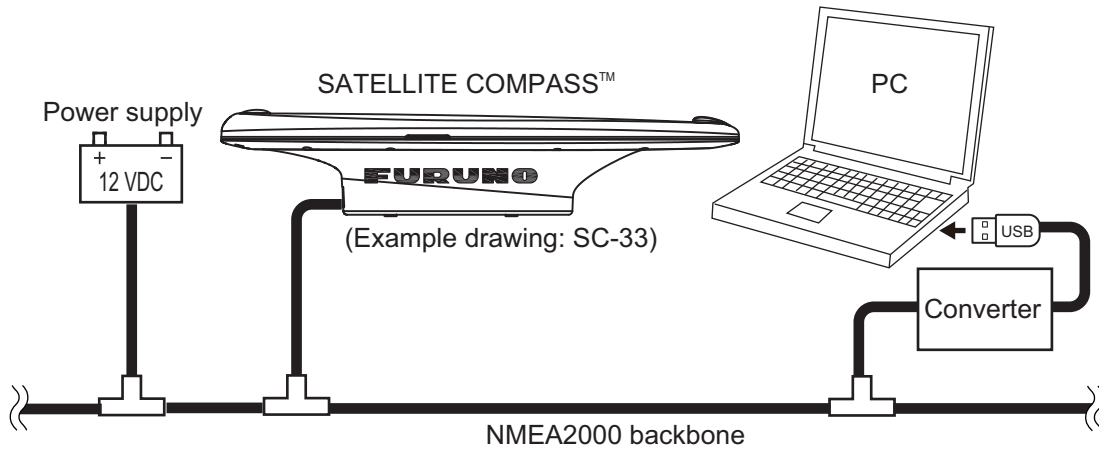

NMEA0183 serial connection (SCX-21)

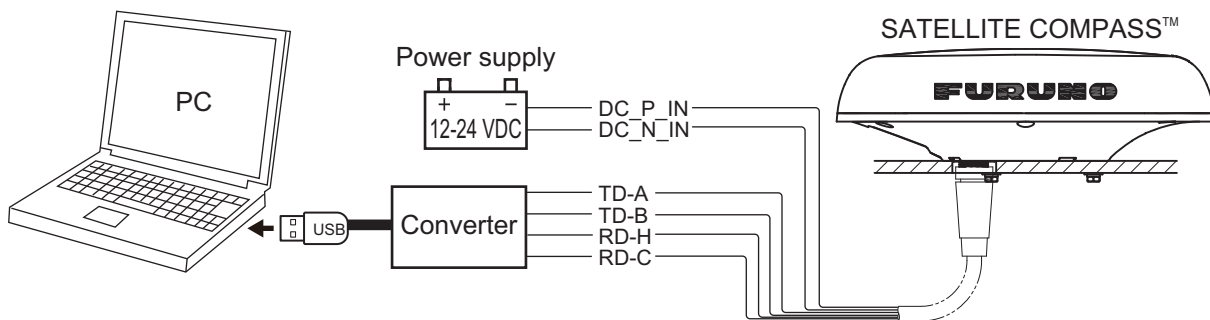

2. Power the SATELLITE COMPASS™ that you want to setup.

Note: When multiple SATELLITE COMPASS™ are connected in the same network, the SC setting tool cannot find and connect to the SATELLITE COMPASS™ correctly. Disconnect all SATELLITE COMPASS™ except the unit to be setup. Other devices do not need to be disconnected.

3. Activate the executable file of the SC setting tool (file name: "SC_Setting_Tool.exe") on your PC to show the [Select Device] dialog box.

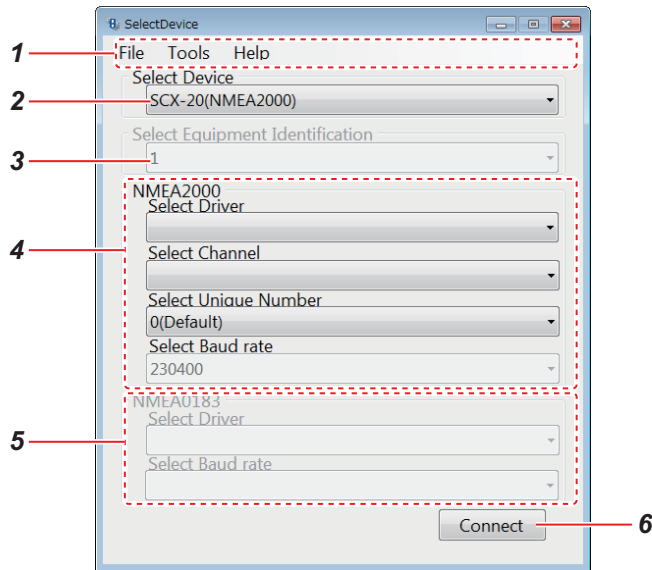

Note: When the following message appears the first time the SC setting tool is activated, install “Microsoft Visual C++® 2010 SP1 Redistributable Package (x86)”. The installer file (vc_redist_x86.exe) is supplied with the SC setting tool. For how to install, follow the on-screen installation instructions.

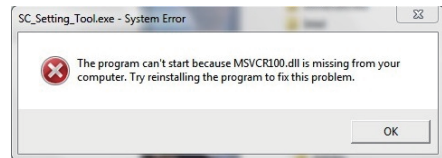

Menu Item		Remarks
1	Menu bar	
	[File] menu	<ul style="list-style-type: none"> • [Close]: Close the SC setting tool.
	[Tools] menu	<ul style="list-style-type: none"> • [Screenshot]: Capture a screenshot of the [Select Device] dialog box (file format: bit map). Click [Screenshot], and the file destination setting dialog box appears. Enter the file name and file location where to save the screenshot.
	[Help] menu	<ul style="list-style-type: none"> • [Usage considerations]: Show the usage considerations for the SC setting tool. • [Language]: Select the display language for the guidance and usage considerations (English or Japanese). Note: The language for the menu items is fixed to English. • [About]: Show the software information about the SC setting tool.
2	Select Device	Select the model number to be connected.
3	Equipment Identification	Not used. This menu item is grayed out.
4	NMEA2000	
	Select Driver* ¹	Select the driver type. Driver type depends on the CAN-USB converter used. <ul style="list-style-type: none"> • For CANUSB: Select [CanUSB.dll]. • For USBcan II and Kvaser Leaf Light HS v2 M12: Select [KVASER.dll].
	Select Channel* ¹	Select the channel name for CAN connection. The channel name shown in the drop down list changes according to the CAN-USB converter used.
	Select Unique Number* ¹	Set up this menu item only when you connect multiple SC setting tools in the same NMEA2000 network (setting range: [0 (Default)] to [5 (Default)]). Be sure to assign a different number to each SC setting tool.
	Select Baudrate* ¹	Not used.

1. OPERATIONAL OVERVIEW

Menu Item		Remarks
5	NMEA0183	Select Driver* ²
		Select Baudrate* ²
6	[Connect] button	Connect the SATELLITE COMPASS™ to be selected on the [Select Device] dialog box. The [SC_Setting_Tool] dialog box appears after clicking the [Connect] button.

*1: Grayed out when the SCX-21 is connected.

*2: Grayed out when the SC-33 or SCX-20 is connected.

- Set the items referring to the table at step 3, then click the [Connect] button to connect the SATELLITE COMPASS™.

The [SC_Setting_Tool] dialog box appears. All setting items on the [SC_Setting_Tool] dialog box are grayed out while connecting the SATELLITE COMPASS™. When the connection is established correctly, the current settings of the SATELLITE COMPASS™ are shown. For details about the [SC_Setting_Tool] dialog box and each setting item, see chapter 2.

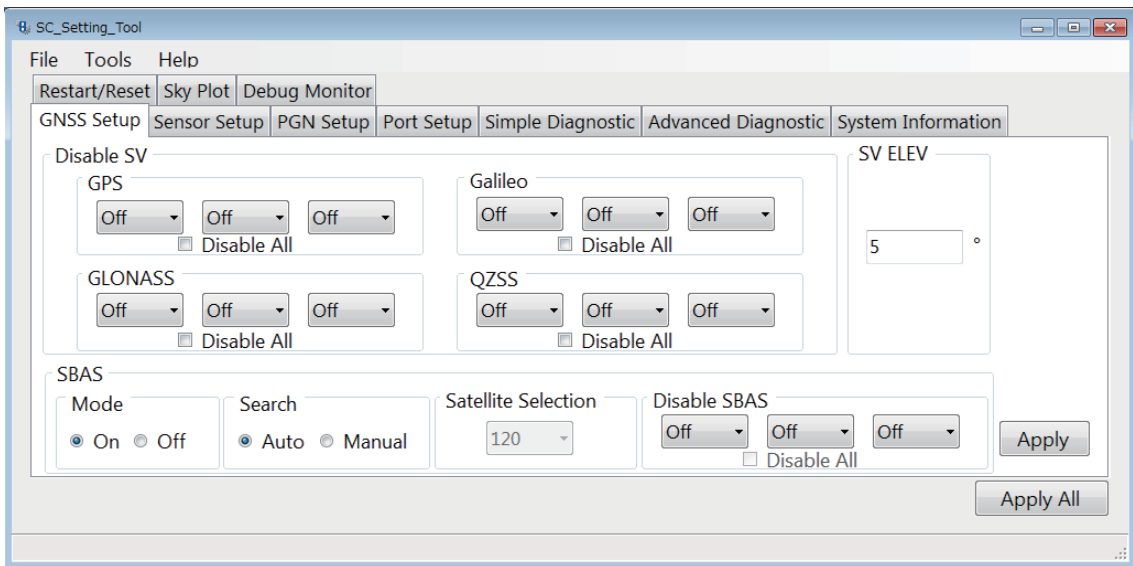

Note: The SC setting tool may not show the setting items correctly due to the OS font size setting. For best performance, the OS font size should be “100%”. Set font size as follows:

- Windows®7: Click the desktop window. → Personalize → Display → Smaller
- Windows®10: Start → Setting → System → Display → Change the size of text, apps, and other items.

1.4.2 How to close the SC setting tool

1. If the settings are not applied to the SATELLITE COMPASS™, click the [Apply] or [Apply All] button on the [SC_Setting_Tool] dialog box to apply the settings.
2. Select [File] from the menu bar, then select [Exit] to close the SC setting tool.
You can also close the SC setting tool by clicking the close button () at the upper right of the dialog box.

1.5 How to Uninstall the SC Setting Tool

Do as follows to uninstall the SC setting tool:

Note 1: Login as administrator to uninstall the SC setting tool.

Note 2: The following uninstalling procedure uses the executable file of the SC setting tool. You can uninstall the SC setting tool from the control panel of the Windows®.

1. Run the executable file of the SC setting tool (file name: SC_Setting _Tool_Installer.msi).
The following setup wizard appears.

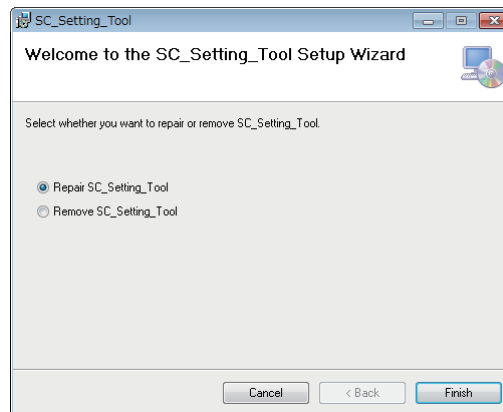

2. Click the [Remove SC_Setting_Tool] radio button.
3. Click the [Finish] button to start the software uninstallation.
The progress bar is shown while uninstalling the SC setting tool. After completing the uninstallation, the confirmation message appears.

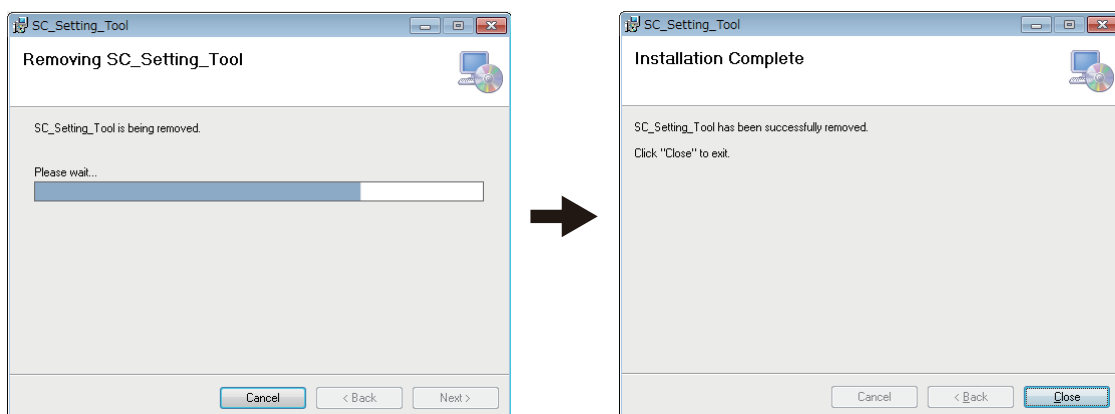

4. Click the [Close] button to close the setup wizard.
The shortcut icon for the SC setting tool is removed automatically after the uninstallation.

2. HOW TO SETUP THE MENU

2.1 Display Layout

Note: If connection between the PC and SATELLITE COMPASS™ is interrupted or stopped (PC battery, cable connection issues, etc.), some or all settings may not be applied to the SATELLITE COMPASS™. If this happens, reconnect and repeat the settings procedure.

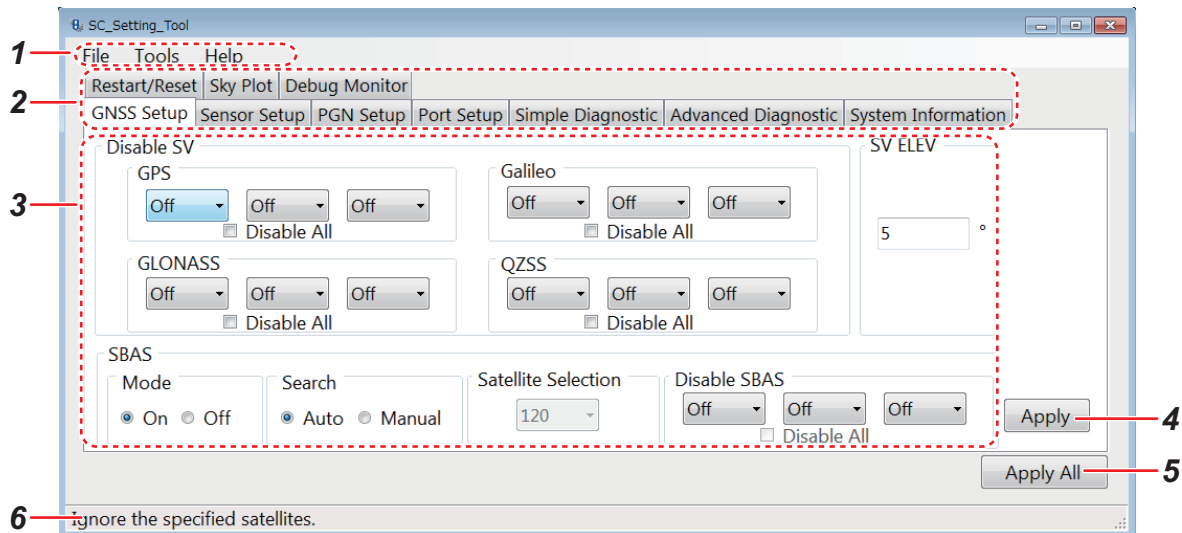

No.	Name	Remarks
1	Menu bar	[File] menu <ul style="list-style-type: none"> • [Disconnect]* : Disconnect from the SATELLITE COMPASS™ and go back to the [Select Device] dialog box. • [Exit]* : Disconnect from the SATELLITE COMPASS™ and close the SC setting tool.
		[Tools] menu <ul style="list-style-type: none"> • [Screenshot]: Capture a screenshot of the [SC_Setting_Tool] dialog box (file format: bit map). Click [Screenshot], and the file destination setting dialog box appears. Enter the file name and file location where to save the screenshot.
		[Help] menu <ul style="list-style-type: none"> • [Usage considerations]: Show the usage considerations for the SC setting tool. • [Language]: Select the display language for the guidance and usage considerations (English or Japanese). Note: The language for the menu items is fixed to English. • [About]: Show the software information about the SC setting tool.
2	Tab buttons	Settings items available in the "View Area" change depending on the tab selected. For tab details, see the remaining sections in this chapter.
3	View Area	Setting items and setting values are displayed according to the selected tab. Settings which have not yet been applied to the SATELLITE COMPASS™ are highlighted in blue; items which cannot be adjusted appear in gray.

No.	Name	Remarks
4	[Apply] button	Click this button to apply the settings on the currently displayed tab. The [Apply] and [Apply All] buttons are grayed out while applying the settings.
5	[Apply All] button	Click this button to apply the settings on all tabs. The [Apply] and [Apply All] buttons are grayed out while applying the settings.
6	Guidance	Show the operational guidance for the menu item selected with the cursor.

*: If settings which have not yet been applied to the SATELLITE COMPASS™ exist, the following confirmation message appears. Click the [No] button to close the message, then apply the settings.

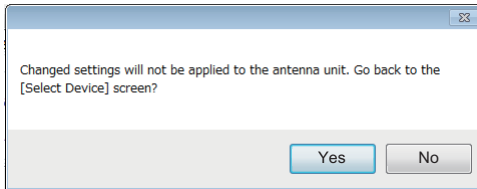

When [Disconnect] is clicked

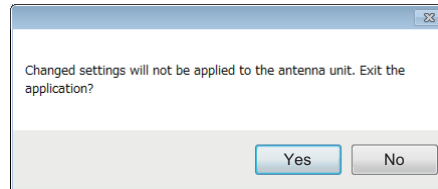

When [Exit] is clicked

2.2 [GNSS Setup] Tab

You can disable (ignore) satellites and adjust the elevation mask from the [GNSS Setup] tab.

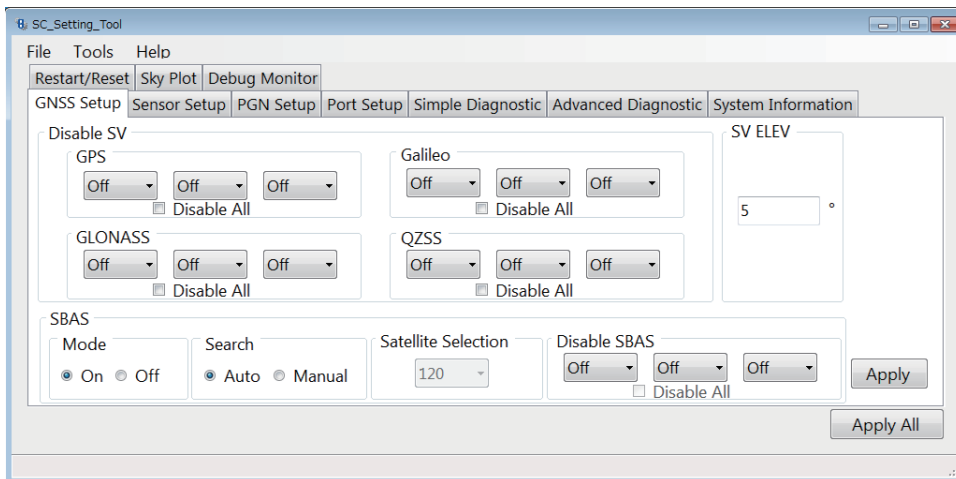

Menu Item		Remarks
Disable SV	GPS	You can ignore satellites by specifying the satellite number with each positioning system (GPS, GLONASS, Galileo, QZSS). A maximum of three satellites can be registered to be ignored. When you check the [Disable All] checkbox, all satellites of the selected positioning system are ignored. In this case, the drop down list for selecting the satellite number is grayed out.
	GLONASS	
	Galileo	
	QZSS	
SV ELEV		Adjust the elevation mask angle. This equipment does not track satellites with an elevation angle lower than the angle set here. A higher elevation mask angle increases the positioning accuracy, but the number of the available satellites may be decreased and the equipment may not be able to obtain an accurate position fix.
SBAS	Mode*	Enable/disable correction from SBAS (Satellite-based Augmentation System). <ul style="list-style-type: none"> [On]: Enable correction from SBAS. [Off]: Disable correction from SBAS.
	Search*	Select [Auto] to search automatically for SBAS satellites, or [Manual] to manually input the SBAS satellite number.

2. HOW TO SETUP THE MENU

Menu Item		Remarks
SBAS	Satellite Selection*	Manually input the SBAS satellite number(s) you want to use. Note 1: This item is only available when [Search] is set to [Manual]. Note 2: A satellite number entered at [Disable SBAS] will be rejected.
	Disable SBAS*	You can ignore SBAS satellites by specifying the satellite number. A maximum of three satellites can be ignored. Note: A satellite number entered at [Satellite Selection] will be rejected.

*: Grayed out when the SC-33 is connected.

2.3 [Sensor Setup] Tab

Enter the ship's information and mounting position of the SATELLITE COMPASS™ and adjust the sensor offset values from the [Sensor Setup] tab.

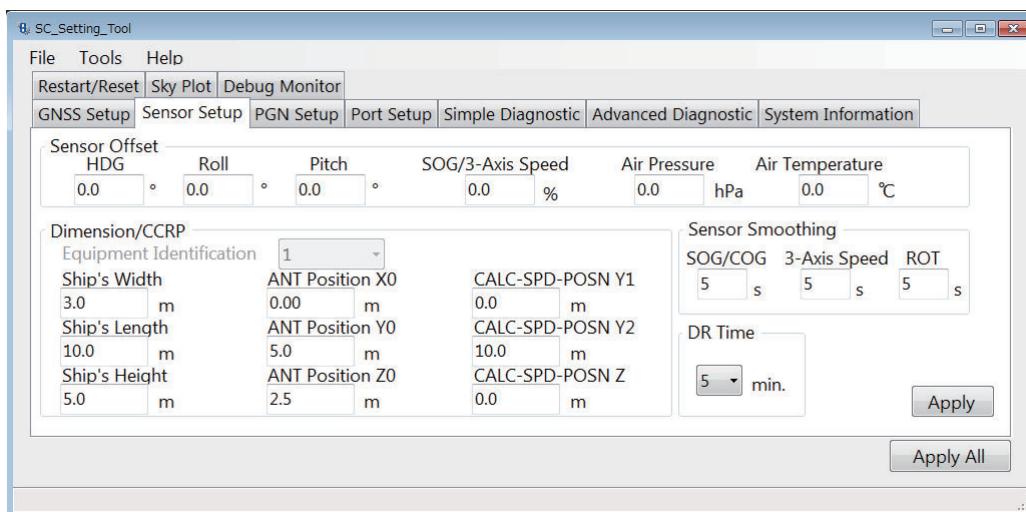

Menu Item		Remarks	Setting range
Sensor Offset	HDG	Offset the heading angle. When the heading angle is skewed right, enter a negative value. When the heading angle is skewed left, enter a positive value.	-180.0 to 180.0°
	Roll	Offset the roll angle.	10.0 to 10.0°
	Pitch	Offset the pitch angle.	-10.0 to 10.0°
	SOG/3-Axis Speed* ¹	Offset the ship's speed and 3-axis speed values.	-12.5 to 12.5%
	Air Pressure	Offset the air pressure value.	-99.9 to 99.9 hPa
	Air Temperature	Offset the air temperature value.	-99.9 to 99.9°C

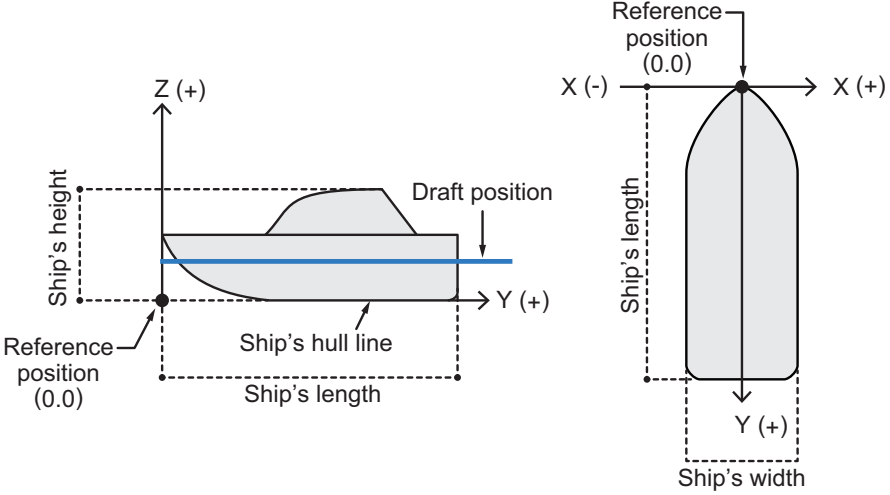
Menu Item	Remarks	Setting range
Dimensions/ CCRP	<p>Enter the appropriate value according to the ship's size, to improve the accuracy of the 3-axis speed. The reference position for mounting position and calculating position of the 3-axis speed are shown in the following figure:</p> 	
Equipment Identification	Not used. This menu item is grayed out.	-
Ship's Width	Set the ship's width, calculated from the port-side to starboard-side of the widest section of the vessel.	1.0 to 999.9 m
Ship's Length	Set the ship's length, calculated to the bow-tip to the stern, along the center of the vessel.	1.0 to 999.9 m
Ship's Height	Set the ship's height, calculated to the bottom of the keel to the top of the mast.	1.0 to 199.9 m
ANT Position X0	Set the port-starboard (Lateral) position of the SATELLITE COMPASS™. Enter negative value for port-side, positive value for starboard-side. The center of the vessel is "0".	Depends on the ship's width.
ANT Position Y0	Set the bow-stern (Longitudinal) position of the SATELLITE COMPASS™. Set the distance from the bow to the stern with the bow as 0 m.	Depends on the ship's length.
ANT Position Z0	Set height of the SATELLITE COMPASS™, from the bottom of the ship.	Depends on the ship's height.
CALC-SPD-POSN Y1	Set the bow-stern position for calculating the 3-axis speed. Ship's speed can be measured at two locations in addition to the antenna position. Enter the backward distance from the reference position (Fwd Center of the bow) to the position where you want to measure the ship's speed. Normally, enter the bow position (Y1) and stern position (Y2). Note: In the default setting, Y1 and Y2 are entered as follows: <ul style="list-style-type: none"> • Y1: 0 m (bow position) • Y2: 10 m (10 m backward from bow position) 	Depends on the ship's length.
CALC-SPD-POSN Y2		

2. HOW TO SETUP THE MENU

Menu Item		Remarks	Setting range
Dimensions/ CCRP	CALC-SPD-POSN Z	Set the height for calculating the 3-axis speed. Enter the distance from the bottom of the ship to the position where you want to measure the ship's speed. For example, enter the draft value when you want to measure the speed at draft position.	Depends on the ship's height.
Sensor Smoothing	HDG ^{*1}	Set the time delay (smoothing) for heading data output.	0 to 9999 sec
	3-Axis Speed ^{*1}	Set the time delay (smoothing) for 3-axis speed data output.	0 to 9999 sec
	ROT ^{*1}	Set the time delay (smoothing) for ROT data output.	0 to 30 sec
DR Time		When the SATELLITE COMPASS™ cannot receive the signal from the satellite, the SATELLITE COMPASS™ keeps outputting the heading data to use dead reckoning for the time set here. If the signal from the satellite cannot be retrieved within the time set here, the SATELLITE COMPASS™ stops outputting the heading data.	0 to 5 min

*1: Grayed out when the SC-33 is connected.

2.4 [PGN Setup] Tab (SC-33/SCX-20 Only)

You can enable/disable PGN output from the SATELLITE COMPASS™ and adjust transmission rate from the [PGN Setup] tab.

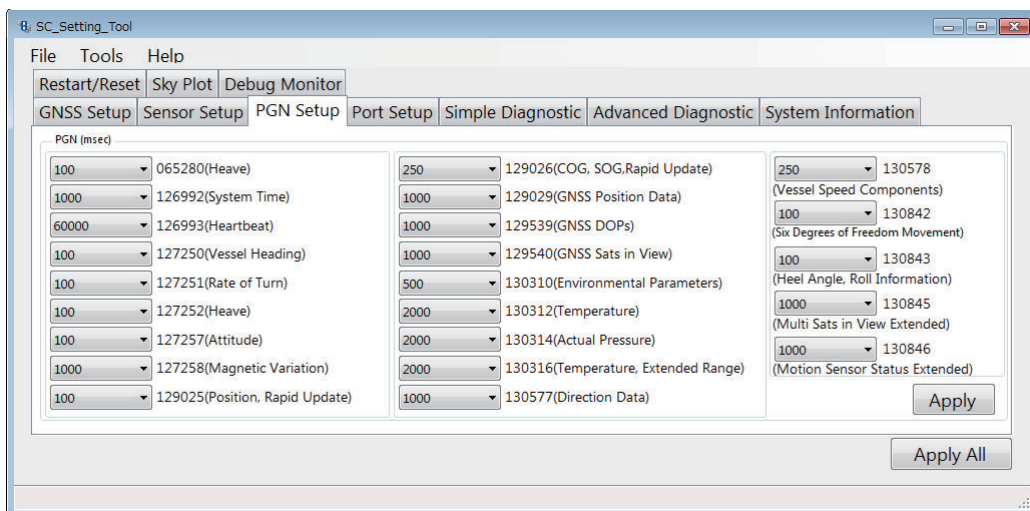

Note: The [PGN Setup] tab is not used in the SCX-21. You can open the tab, however all setting items are grayed out and cannot be adjusted.

How to set the transmission rate

All PGNs that the connected SATELLITE COMPASS™ can output are shown on the [PGN Setup] tab. Unavailable PGNs are grayed out and the setting cannot be adjusted.

To change the transmission rate, click the drop down list for the PGN to be set and select the appropriate value. If you want to disable the PGN, select [Off]. The setting range changes according to the PGN. For the setting range of each PGN, see "MENU TREE" on page AP-1.

Note: Normally, keep the default setting. If there is a need to change the transmission rate, only change the rate for necessary PGNs. An excessive number of PGNs with a low transmission rate can cause problems with PGN output and transmission rates.

2.5 [Port Setup] Tab (SCX-21 Only)

You can setup output data format for each serial channel (data port) on the SCX-21.

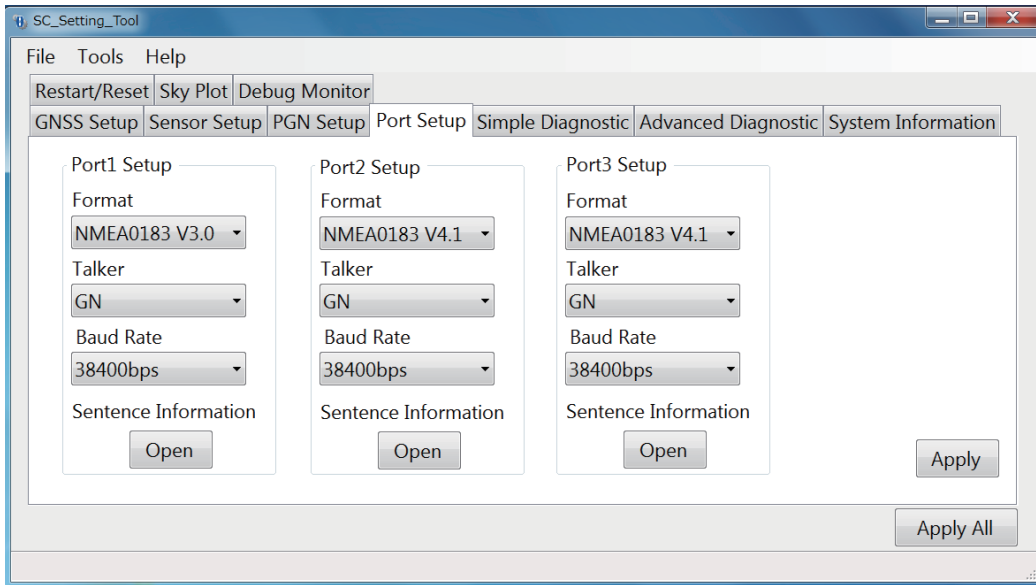

Note: The [Port Setup] tab is not used in the SC-33 and SCX-20. You can open the tab, however all setting items are grayed out and cannot be adjusted.

Menu item		Remarks
Port1 Setup/ Port2 Setup/ Port3 Setup	Format	Select the data format for output data. Select the appropriate version according to the connected equipment.
	Talker	Select the talker for the output data from the SATELLITE COMPASS™.
	Baud Rate	Select the baud rate of the SATELLITE COMPASS™. Note: When the baud rate setting is changed from 38,400 bps to 4,800 bps and communication load rate exceeds 100%, the following message appears. In this case, adjust the output sentence settings so that the communication load rate is 100% or less.

Selected baud rate will cause the load rate to exceed 100%. Adjust sentence settings to allow this baud rate.

OK

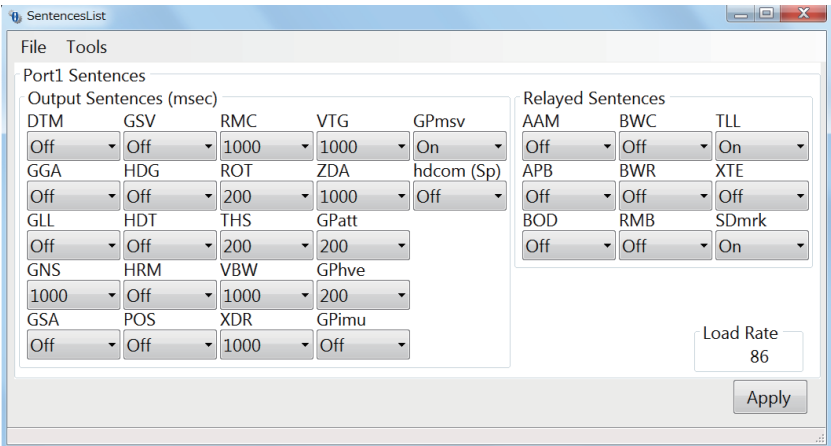
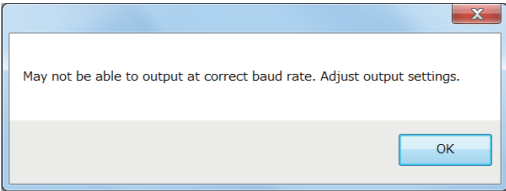
Menu item	Sentence Information	Remarks
Port1 Setup/ Port2 Setup/ Port3 Setup		<p>Click the [Open] button, and the [SentenceList] dialog box appears. All sentences that the connected SATELLITE COMPASS™ can output are shown on the [SentenceList] dialog box. You can turn each sentence on or off and adjust the transmission rate.</p>  <p>The current communication load rate is shown at [Load Rate] box. When the communication load rate exceeds 100%, the following message appears. Adjust the output sentence settings so that the communication load rate is 100% or less.</p> 

2.6 [Simple Diagnostic] Tab

You can perform a simple diagnostic test on the [Simple Diagnostic] tab.

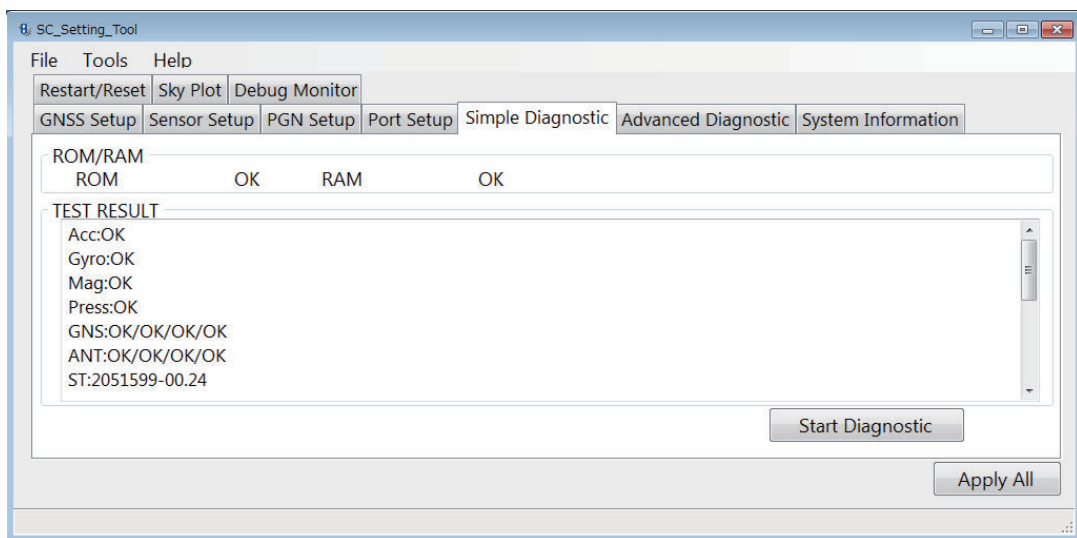

2. HOW TO SETUP THE MENU

Simple diagnostic test

Click the [Stat Diagnostic] button on the [Simple Diagnostic] tab to start the simple diagnostic test. The simple diagnostic test checks the performance of the SATELLITE COMPASS™. The following table shows the test result of the simple diagnostic test:

Test Result		Remarks
Common test results		
ROM/RAM	ROM	ROM test result (OK or NG).
	Internal RAM	Internal RAM test result (OK or NG).
Test result for SC-33		
TEST/RESULT	GYRO	Gyro sensor test result (OK or NG). From left: X-axis, Y-axis, Z-axis test result
	ACC	Acceleration sensor test result (OK or NG). From left: X-axis, Y-axis, Z-axis test result
	G1	Memory test result for GNSS core 1 to 3 (OK or NG) and version information.
	G2	
	G3	
	ENV	Air pressure sensor test result (OK or NG).
	MAG	Magnetic sensor test result (OK or NG).
	ANT	The software version of the SATELLITE COMPASS™ and software released date (yyyy/mm/dd/hh/mm).
	MT	Operating time of the MAIN board (unit: hour).
ST	Operating time of the SUB_IMU board (unit: hour).	
Test result for SCX-20		
TEST/RESULT	Acc	Acceleration sensor status (OK or NG).
	Gyro	Gyro sensor status (OK or NG).
	Mag	Magnetic sensor status (OK or NG).
TEST/RESULT	Press	Air pressure/temperature sensor status (OK or NG).
	GNS	Memory status for GNSS core 1 to 4 (OK or NG).
	ANT	Status for antenna 1 to 4 (OK or NG).
	ST	Version information for the starter program.
	B1	Version information for the booter 1 program.
	B2	Version information for the booter 2 program.
	G1	Version information for GNSS core 1 to 4.
	G2	
	G3	
	G4	
	Time	Operating time from when the SATELLITE COMPASS™ is turned on.
Overall	Total operating time from the first time the SATELLITE COMPASS™ is started.	
Test result for SCX-21		
TEST/RESULT	Rate Gyro	Gyro sensor status (Good or Bad).
	Acceleromtr	Acceleration sensor status (Good or Bad).
	Magnetic	Magnetic sensor test status (Good or Bad).
	Press.Temp.	Air pressure/temperature sensor status (Good or Bad).
	Installation	The number of times antenna vibration is detected
	GNS	Status for GNSS core 1 to 4 (OK or NG).
	ANT	Status for antenna 1 to 4 (OK or NG).

2.7 [Advanced Diagnostic] Tab (SCX-21 Only)

You can perform the advanced diagnostic test from the [Advanced Diagnostic] tab.

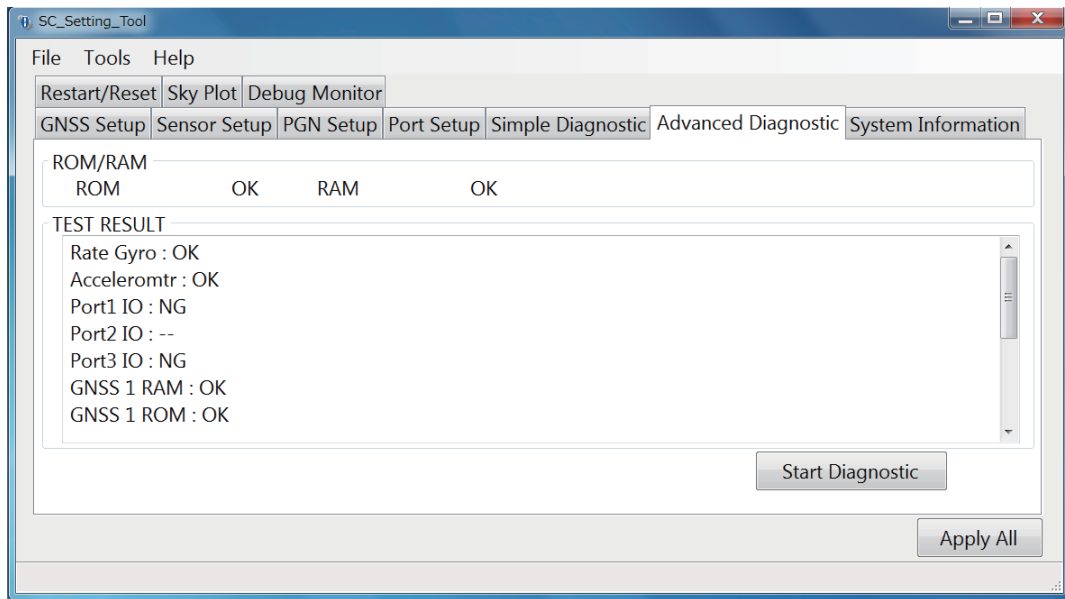

Note: The [Advanced Diagnostic] tab is not used in the SC-33 and SCX-20. You can open the tab, however all contents are grayed out and cannot be adjusted.

Advanced diagnostic test

Click the [Stat Diagnostic] button on the [Advanced Diagnostic] tab to start the advanced diagnostic test. The following message appears.

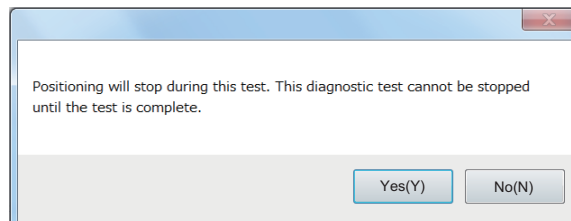

The SATELLITE COMPASS™ stops positioning while performing the advanced diagnostic test. Also, you cannot abort the advanced diagnostic test until the test results are shown. Therefore, do the test when position data is not required (in port, etc.). Click the [Yes] button to start the test.

The following table shows the test result of the advanced diagnostic test:

Test result		Remarks
ROM/ RAM	ROM	ROM test result (OK or NG).
	RAM	Internal RAM test result (OK or NG).
TEST/ RESULT	Rate Gyro	Gyro sensor test result (OK or NG).
	Acceleromtr	Acceleration sensor test result (OK or NG).
	Port1 IO	Loop back test result for serial port 1 and 3. The serial port 2 cannot perform the loopback test. Therefore, the test result for the serial port 2 always shows "--". Note: The loopback test tool is required to perform this test.
	Port2 IO	
	Port3 IO	
	GNSS 1 RAM to GNSS 4 RAM	RAM test result for GNSS 1 to GNSS 4 (OK or NG).
	GNSS 1 ROM to GNSS 4 ROM	ROM test result for GNSS 1 to GNSS 4 (OK or NG).

2.8 [System Information] Tab (SCX-20/SCX-21 Only)

The [System Information] tab shows the system information of the SATELLITE COMPASS™.

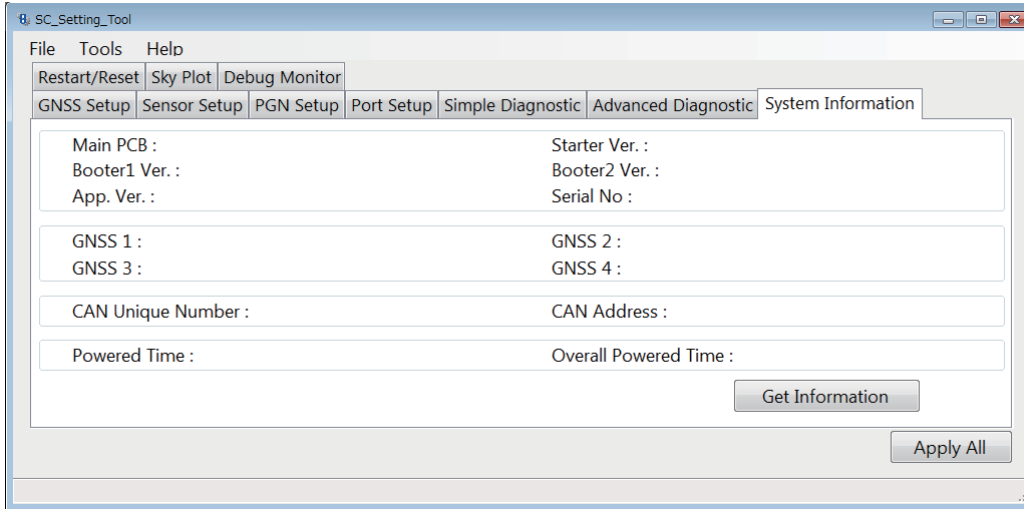

Note: The [System Information] tab is not used in the SC-33. You can open the tab, however all contents are grayed out and cannot be adjusted.

How to show the system information

Click the [Get Information] button to show the system information.

Item	Remarks
Main PCB	Main board version number
Starter Ver.	Program version number for the starter program
Booter1 Ver.	Program version number for the booter 1 program
Booter2 Ver.	Program version number for the booter 2 program
App. Ver.	Program version number for the application program
Serial No	Serial number
GNSS 1 to GNSS 4	Version information for GNSS 1 to GNSS 4
CAN Unique Number*	CAN unique ID for the NMEA2000 network
CAN Address*	CAN address for the NMEA2000 network
Powered Time	Operating time from when the SATELLITE COMPASS™ is turned on.
Overall Powered Time	Total operating time from the first time SATELLITE COMPASS™ is started.

*: Grayed out when the SCX-21 is connected.

2.9 [Restart/Reset] Tab

You can restart the SATELLITE COMPASS™ and restore factory default settings from the [Restart/Reset] tab.

Note: If the hdcom (Sp) sentence is turned on at the [SentenceList] dialog box (see section 2.5), the hdcom (Sp) sentence is turned off automatically to restart the SATELLITE COMPASS™ or restore factory default settings.

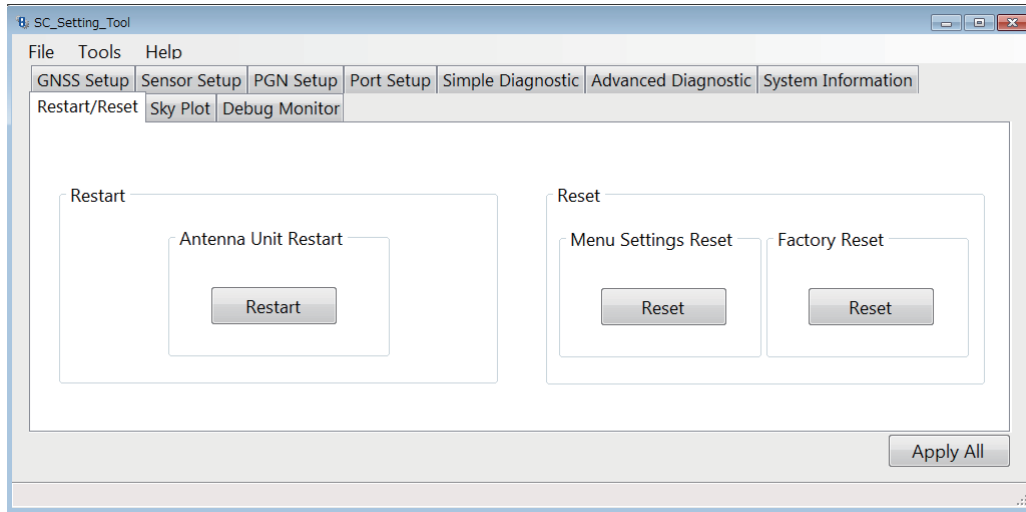

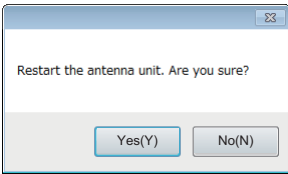
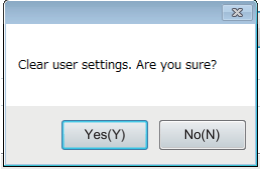
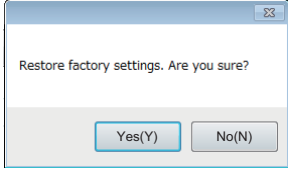
Item		Remarks
Restart	Antenna Unit Restart	Click the [Restart] button to restart the antenna unit. The message shown to the right appears. Click the [Yes] button to restart the SATELLITE COMPASS™. All buttons are grayed out during the restarting. 
Reset	Menu Settings Reset	Click the [Reset] button to reset user settings. The message shown to the right appears. Click the [Yes] button to clear all user settings. All buttons are grayed out while restoring the factory default settings. 
	Factory Reset	Click the [Reset] button to restore factory default settings. The message shown to the right appears. Click the [Yes] button to restore all default settings. All buttons are grayed out while restoring the factory default settings. 

2.10 [Sky Plot] Tab

The [Sky Plot] tab shows the available satellites and their elevation.

Note: The following PGNs or sentences should be output from the SATELLITE COMPASS™ to show the information on the [Sky Plot] tab.

For SC-33/SCX-20

- PGN: 127250 (Vessel Heading)
- PGN: 130845 (Multi Sats in View Extended)
- PGN: 130846 (Motion Sensor Status Extended)

For SCX-21

- THS, HDT or GPatt sentence
- GPmsv sentence
- hdcom (Sp) sentence
- Baud rate: 38,400 bps

When the output settings are not correct, the message shown to the right appears.

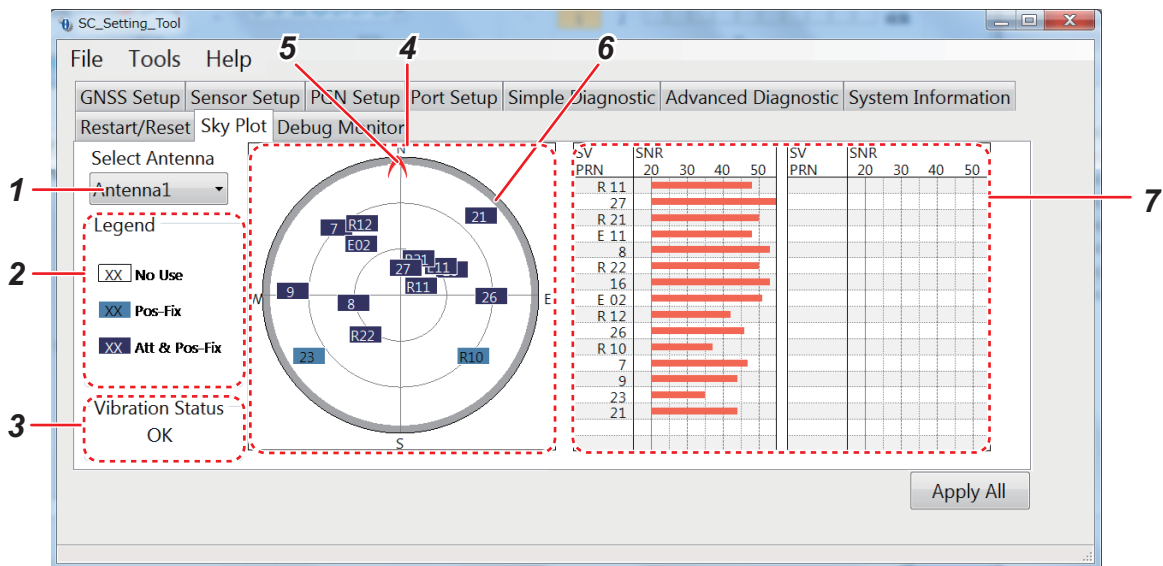
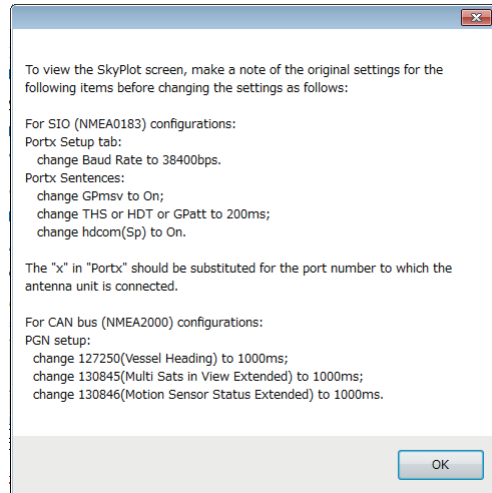

No.	Name	Remarks
1	Select Antenna	Select the antenna number for which to show the satellite information ([Antenna 1] to [Antenna 4]). Note: [Antenna 1] and [Antenna 2] are available for SC-33. However you can select [Antenna 3] and [Antenna 4] - the satellite information is not displayed.
2	Legend	The legend of the satellite location for positioning: <ul style="list-style-type: none"> • [No Use]: Not used for positioning. • [Pos-Fix]: Used for positioning fix only. • [Att & Pos Fix]: Used for attitude and positioning fix.
3	Vibration Status	The vibration and impact test result (OK or NG). This test result indicates whether the mounting position is appropriate or not.

No.	Name	Remarks
4	Satellite location	Shows the available satellites and their elevation, which are detected by the sensor selected at [Select Antenna]. When a satellite overlaps another, the satellite whose elevation angle is the highest is displayed on top of the other satellite. The center of the circle indicates the own ship position and elevation angle "90°". The satellite number for each positioning system is as follows: <ul style="list-style-type: none"> • GPS: 1 to 32 • GLONASS: R01 to R24 • Galileo: E01 to E36 • QZSS: 193 to 197
5	Heading marker	Shows the heading direction.
6	Elevation mask angle	Gray shaded area indicates area for the elevation mask that is set at [SV ELEV] on the [GNSS Setup] tab. The equipment does not track any satellite in this area.
7	Receiver signal level	Shows the SNR (signal-to-noise ratio) in bar graph format, in descending order of the elevation angle. When the SNR is 40 or higher, the reception environment is ideal.

2.11 [Debug Monitor] Tab (SCX-20/SCX-21 Only)

You can export the received PGNs or sentence information, offline data and system log file from the [Debug Monitor] tab.

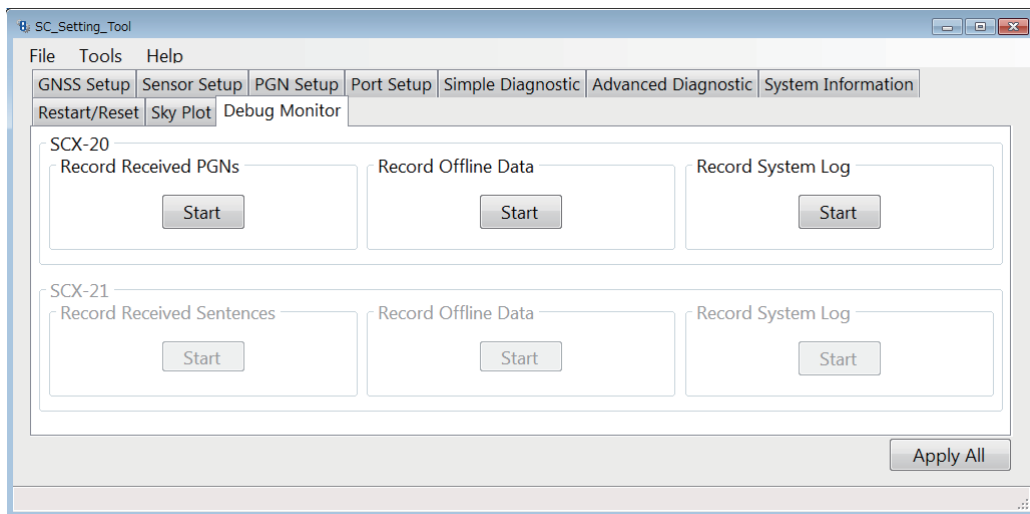

Note 1: The [Debug Monitor] tab is not used in the SC-33. You can open the tab, however all contents are grayed out and cannot be adjusted.

Note 2: Before exporting the offline data, setup the PC as follows:

- Deactivate the sleep mode:
[Control Panel] → [Hardware and Sound] → [Power Options] → [Change Plan Settings] → [On Battery: Never; Plugged In: Never]
- Deactivate the screen saver:
[Control Panel] → [Appearance and Personalization] → [Personalization] → [Screen Saver] → [Screen Saver: None]

2. HOW TO SETUP THE MENU

Item	Remarks
SCX-20	
Record Received PGNs	Export received PGNs and time information. Click the [Start] button. The file destination dialog box appears. Select the file location for the export file. After selecting the file location, recording process is started and the [Start] button is replaced with the [Stop] button. To stop recording, click the [Stop] button. The PGN information received until you stop recording is exported (file format: csv).
Record Offline Data	Export CAN offline data. Click the [Start] button. The confirmation message* appears. Click the [Yes] button to export the data. After clicking the [Yes] button, the file destination dialog box appears. Select the file location for the export file. After selecting the file location, recording process is started and the [Start] button is replaced with the [Stop] button. To stop recording, click the [Stop] button. The offline data received until you stop recording is exported (file format: bin).
Record System Log	Export the system log data of the SATELLITE COMPASS™. Click the [Start] button. The confirmation message* appears. Click the [Yes] button to export the data. After clicking the [Yes] button, the file destination dialog box appears. Select the file location for the export file. After selecting the file location, recording process is started and the [Start] button is replaced with the [Stop] button. To stop recording, click the [Stop] button. The system log data received until you stop recording is exported (file format: bin).
SCX-21	
Record Received Sentences	Export received sentences and time information. Click the [Start] button. The file destination dialog box appears. Select the file location for the export file. After selecting the file location, recording process is started and the [Start] button is replaced with the [Stop] button. To stop recording, click the [Stop] button. The sentence information received until you stop recording is exported (file format: csv).
Record Offline Data	Export serial input/output offline data. Click the [Start] button. The confirmation message* appears. Click the [Yes] button to export the data. After clicking the [Yes] button, the file destination dialog box appears. Select the file location for the export file. After selecting the file location, recording process is started and the [Start] button is replaced with the [Stop] button. To stop recording, click the [Stop] button. The offline data received until you stop recording is exported (file format: bin).
Record System Log	Export the system log data of the SATELLITE COMPASS™. Click the [Start] button. The confirmation message* appears. Click the [Yes] button to export the data. After clicking the [Yes] button, the file destination dialog box appears. Select the file location for the export file. After selecting the file location, recording process is started and the [Start] button is replaced with the [Stop] button. To stop recording, click the [Stop] button. The system log data received until you stop recording is exported (file format: bin).

*: The following confirmation message appears when you export the offline and system log data. Exporting the offline and system log data should only be used to determine the reason for error. Also, it is required to restart the SATELLITE COMPASS™ on the [Restart/Reset] tab after exporting data, referring to section 2.9.

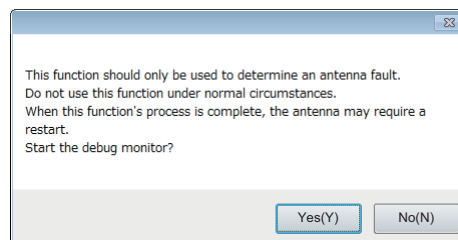

APPENDIX 1 MENU TREE

[SC_Setting_Tool] dialog box

Default settings are shown in bold italic.

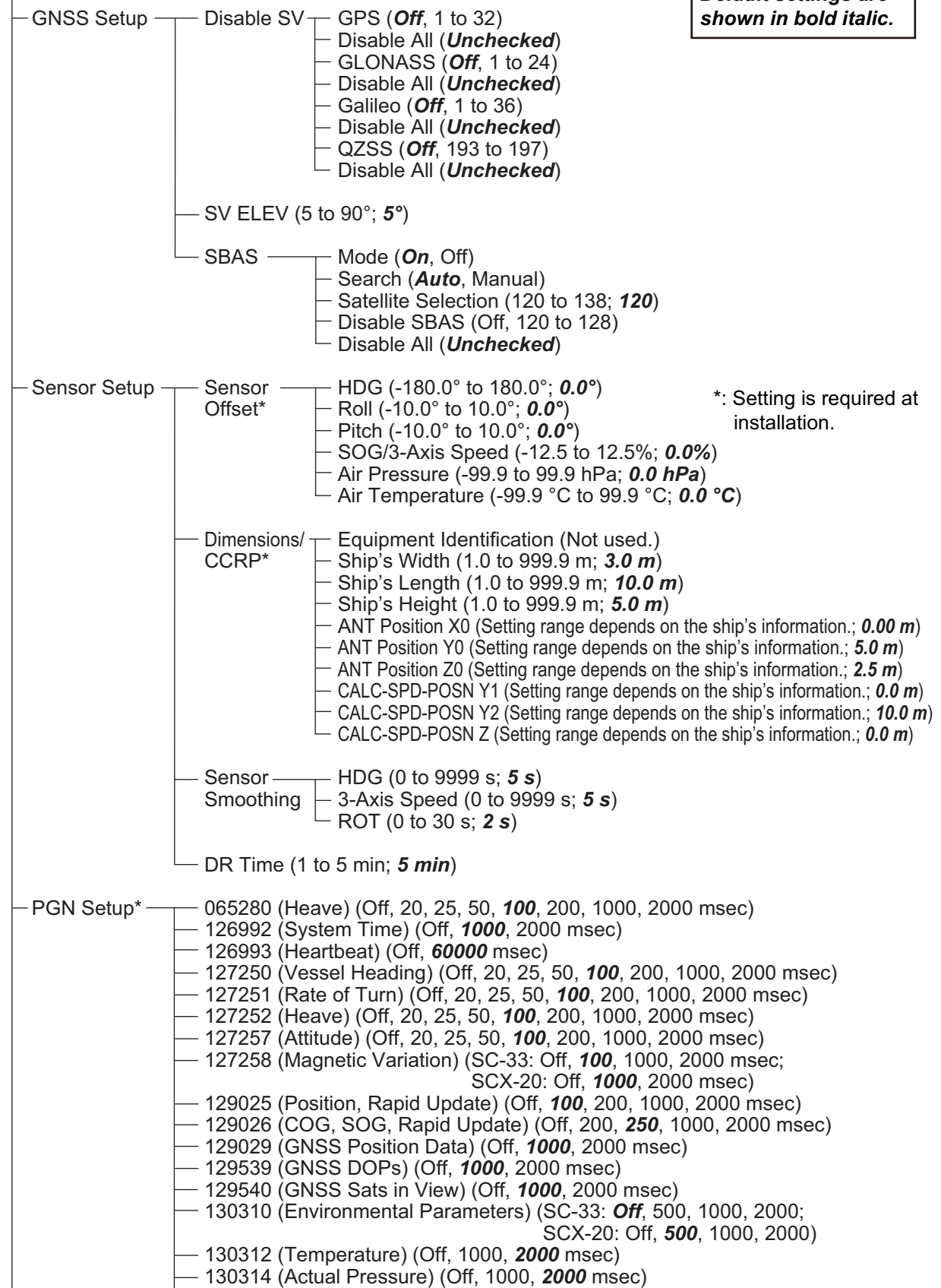

①

②

APPENDIX 1 MENU TREE

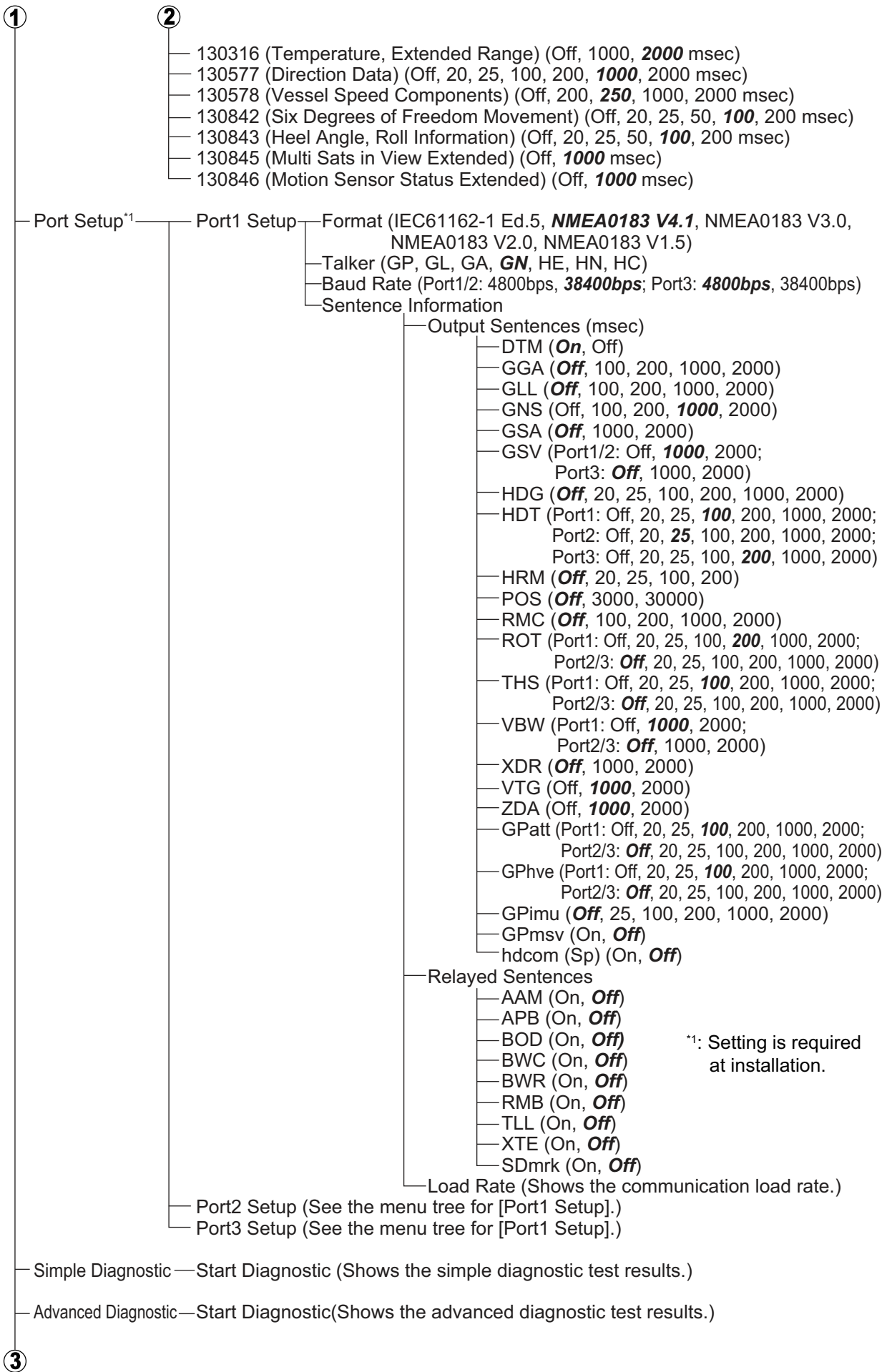

*1: Setting is required at installation.

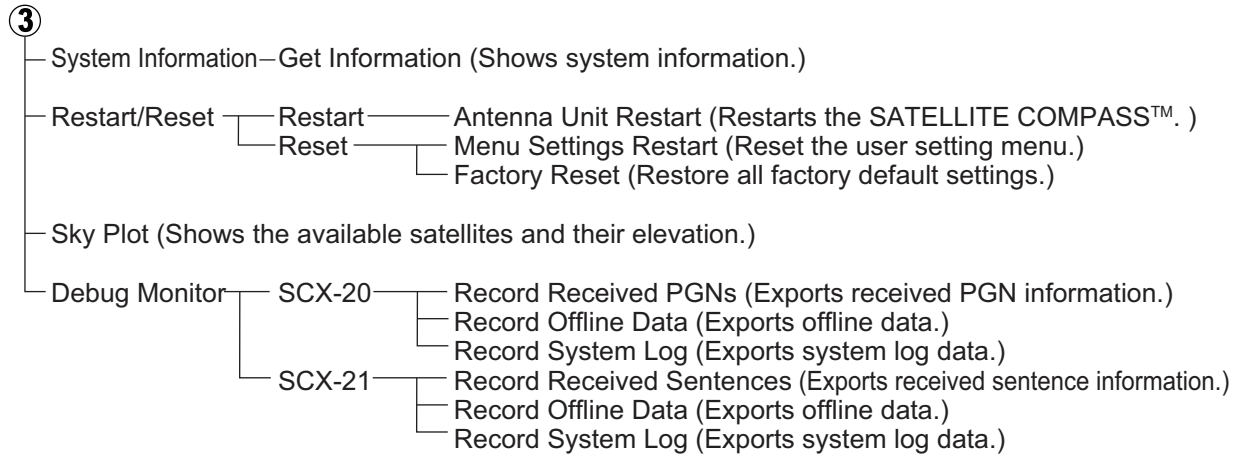

ECF

(Elemental Chlorine Free)

The paper used in this manual
is elemental chlorine free.

FURUNO ELECTRIC CO., LTD.

9-52 Ashihara-cho,
Nishinomiya, 662-8580, JAPAN

• FURUNO Authorized Distributor/Dealer

All rights reserved. Printed in Japan

Pub. No. OME-72851-B

(REFU) SC-33 (SW)

A : MAY 2018

B : JAN. 20, 2020



0 0 0 1 9 4 9 6 6 1 1